







 See Product Manual for complete installation and programming instructions.

## 1.0 Out-of-Box

### 1.1 Verify that you have received all of the parts listed

	X 1 K-1900-8-IP or K-1900-8-IP-EWP VoIP Entry Phone with Handset and Keypad
	X 1 Torx T-10 Security Bit
	X 14 Gel-Filled Butt Connectors

	X 1 Cable Assembly
	X 8 6-32 x 3/4" Flat Head Torx Drive Screws
	X 1 Rough In Box
	X 1 Wire Nut
	X 4 Kepnut #6

### 1.2 Download the product manual

Scan the QR code to open and download the product manual

- OR -



1. Go to [www.vikingelectronics.com](http://www.vikingelectronics.com) and enter **K-1900-8-IP** in the search box
2. Click **K-1900-8-IP** in the search results
3. Click **Product Manual** to open and download the PDF

### 1.3 Download and install the programming software

1. Go to [www.vikingelectronics.com](http://www.vikingelectronics.com) and enter **K-1900-8-IP** in the search box
2. Click **K-1900-8-IP** in the search results
3. Scroll down the page to Downloads, click **IP Programming Software**
4. Install the programming software by saving or opening the file and then clicking on **setup Viking IP Programming.exe**
5. Follow the prompts on your screen to complete software installation

## 2.0 Power Source

Select **PoE Switch** or **PoE Injector** that meets the following requirements:

1. IEEE 802.3af / 802.3at / 802.3bt compliant
2. Capable of providing at least 4 Watts (class 1)

**Note:** CAT5e (or higher) cable recommended

# 3.0 Network Port Settings

- Make sure the port is not in trunk mode
- Make sure port is capable of 100mbps full duplex
- Disable Spanning Tree Protocol (STP) or enable Portfast

# 4.0 Features Overview

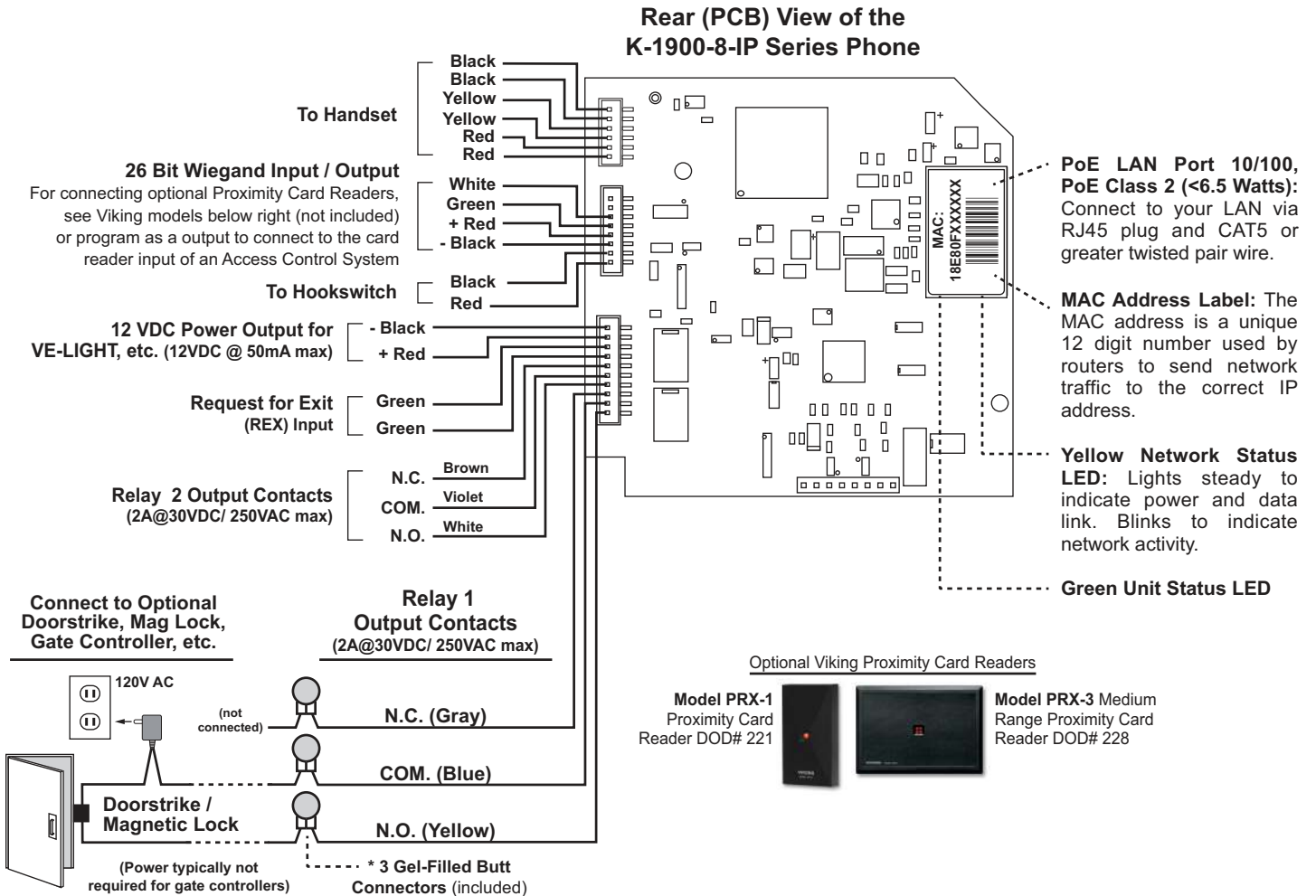

**Note:** The gel-filled (water-tight) butt connectors are designed for insulation displacement on 19-26 gauge wire with a maximum insulation of 0.082 inches. Cut off stripped wire ends before terminating.

See the Product Manual for complete installation and programming instructions.  
Questions? Call Viking Product Support: 715-386-8666

Due to the dynamic nature of the product design, the information contained in this document is subject to change without notice. Viking Electronics, and its affiliates and/or subsidiaries assume no responsibility for errors and omissions contained in this information. Revisions of this document or new editions of it may be issued to incorporate such changes.