







QUICK START GUIDE

▲ See Product Manual for complete installation and programming instructions.

1.0 Out-of-Box

1.1 Verify that you have received all of the parts listed

	X 1	E-1600-IP or E-1600-IP-EWP Emergency Phone
	X 1	Hexkey 5/64
	X 3	Gel-Filled Butt Connectors

	X 1	Back Panel
	X 1	Screw Set 8-32 Socket
	X 1	Wire Nut

1.2 Download the product manual

Scan the QR code to
open and download
the product manual

- OR -



1. Go to **www.vikingelectronics.com** and enter **E-1600-IP** in the search box
2. Click **E-1600-IP** in the search results
3. Click **Product Manual** to open and download the PDF

1.3 Download and install the programming software

1. Go to **www.vikingelectronics.com** and enter **E-1600-IP** in the search box
2. Click **E-1600-IP** in the search results
3. Scroll down the page to Downloads, click **IP Programming Software**
4. Install the programming software by saving or opening the file and then clicking on **setup Viking IP Programming.exe**
5. Follow the prompts on your screen to complete software installation

2.0 Power Source

Select **PoE Switch** or **PoE Injector** that meets the following requirements:

1. IEEE 802.3af / 802.3at / 802.3bt compliant
2. Capable of providing at least 4 Watts (class 1)

Note: CAT5e (or higher) cable recommended

3.0 Network Port Settings

- Make sure the port is not in trunk mode
- Make sure port is capable of 100mbps full duplex
- Disable Spanning Tree Protocol (STP) or enable Portfast

4.0 Features Overview

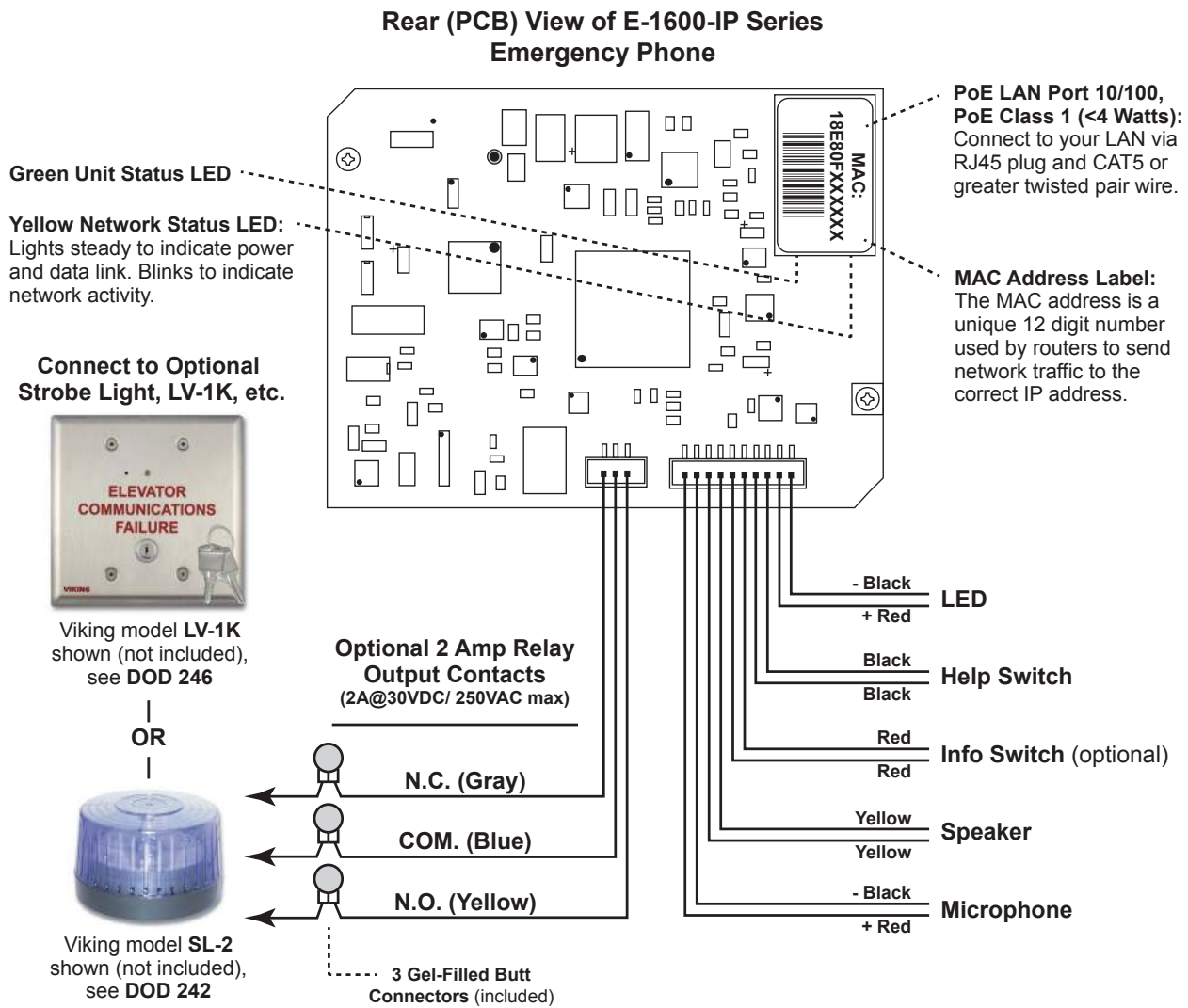

Note: The gel-filled (water-tight) butt connectors are designed for insulation displacement on 19-26 gauge wire with a maximum insulation of 0.082 inches. Cut off stripped wire ends before terminating.

*See the Product Manual for complete installation and programming instructions.
Questions? Call Viking Product Support: 715-386-8666*

Due to the dynamic nature of the product design, the information contained in this document is subject to change without notice. Viking Electronics, and its affiliates and/or subsidiaries assume no responsibility for errors and omissions contained in this information. Revisions of this document or new editions of it may be issued to incorporate such changes.