

VB-AUD-201

Conference Speakerphone User Guide

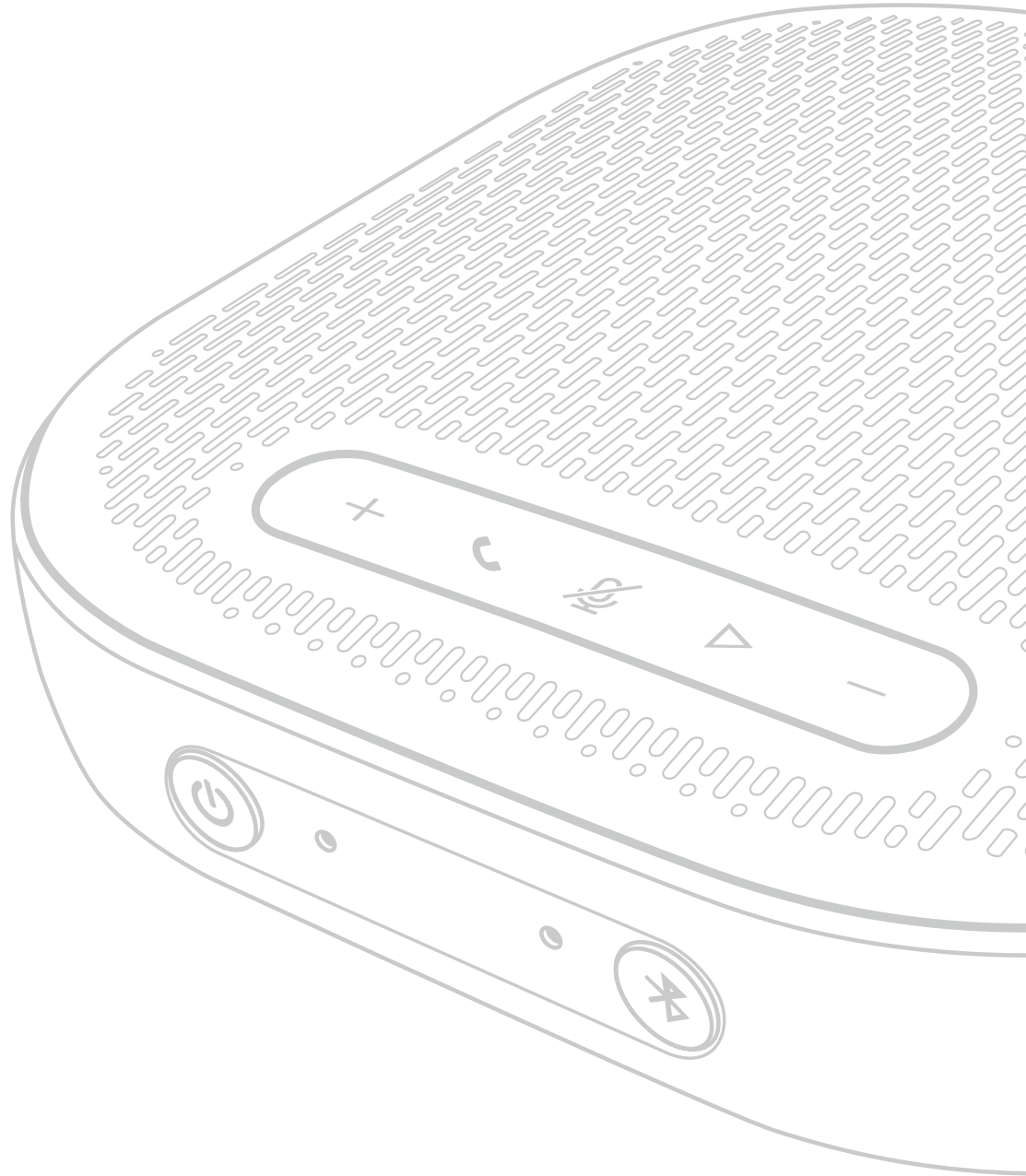

IMPORTANT: Please read this User Guide to obtain important information on installing and using your product in a safe manner, as well as registering your product for future service. Warranty information contained in this User Guide will describe your limited coverage from ViewSonic® Corporation, which is also found on our web site at <http://www.viewsonic.com> in English, or in specific languages using the Regional selection box of our website.

Model No. VS19004
P/N: VB-AUD-201

Thank you for choosing ViewSonic®

As a world-leading provider of visual solutions, ViewSonic® is dedicated to exceeding the world's expectations for technological evolution, innovation, and simplicity. At ViewSonic®, we believe that our products have the potential to make a positive impact in the world, and we are confident that the ViewSonic® product you have chosen will serve you well.

Once again, thank you for choosing ViewSonic®!

Contents

Product Overview.....	4
Package Contents	4
Overview.....	5
Making Connections.....	6
USB Connection	6
Bluetooth Connection	6
Audio Output	7
Using the Speakerphone.....	8
Powering On/Off	8
Button Control.....	9
Status LED Indicator.....	9
Charging.....	10
Charging the Speakerphone.....	10
Charging External Equipment.....	10
Troubleshooting.....	11
Specifications	12
Regulatory and Service Information	14
Compliance Information.....	14
FCC Compliance Statement.....	14
FCC Radiation Exposure Statement.....	15
Industry Canada Statement Compliance.....	15
IC Warning Statement	15
Country Code Statement.....	15
IC Radiation Exposure Statement.....	16
CE Conformity for European Countries.....	16
Declaration of RoHS2 Compliance.....	17
Copyright Information	19
Customer Service	20
Limited Warranty	21
Mexico Limited Warranty.....	24

Product Overview

Package Contents

Please take a moment to check if all the necessary items are included in the package. If anything is missing or damaged, please contact your dealer immediately.

VB-AUD-201

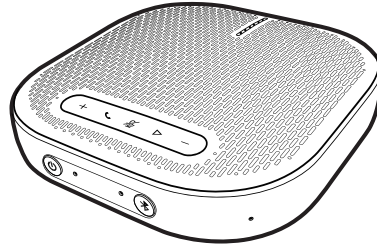

Carrying case

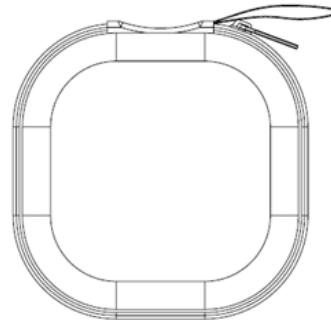

USB 2.0 Type-C Male to USB Type-A Male 1M cable x 1

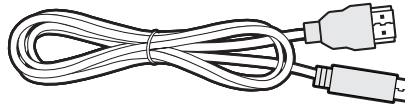

Quick start guide (QSG)

ViewSonic  **2 Overview**

VB-AUD-201 Converse Conference Speakerphone Quick Start Guide

1 Contents

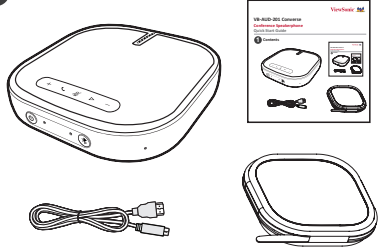

3 Getting Started

Connection

a) USB Connection



b) Bluetooth Connection



2 Overview

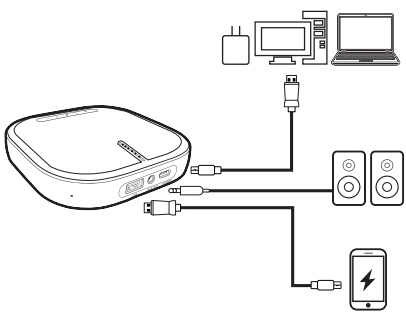

Overview

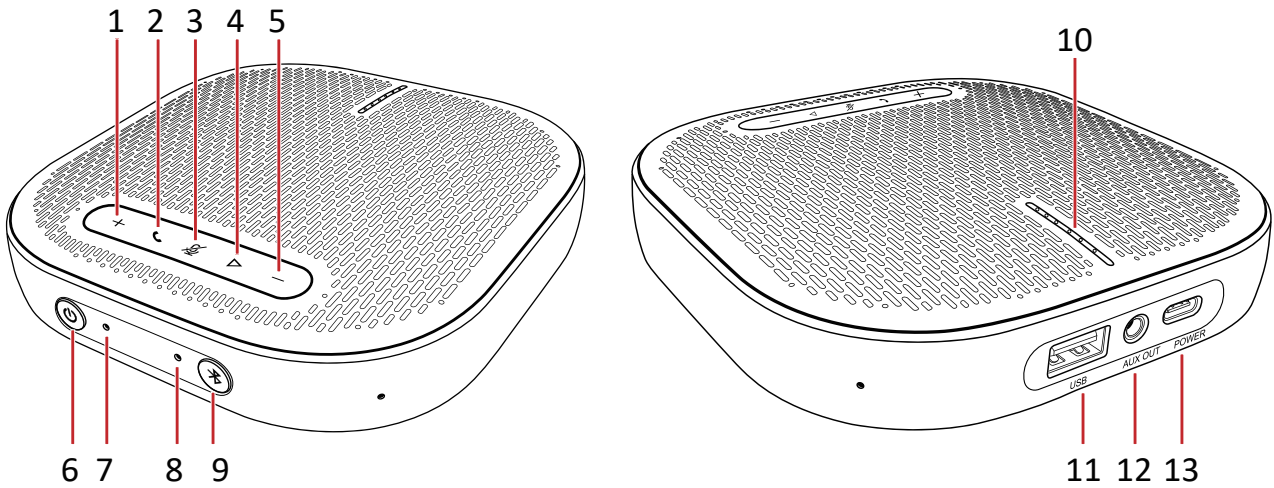

1	Volume up button	8	Bluetooth LED indicator
2	Call button	9	Bluetooth button
3	Mute button	10	Status indicator
4	Multi-function button	11	USB port for charging output (Type-A)
5	Volume down button	12	Audio output port
6	Power button	13	USB port for charging input (Type-C)
7	Power LED indicator		

Warning

- Do not expose the product to a wet environment; and do not place liquid containers (e.g., vases) on the product.
- Do not put uncovered sources of ignition (e.g., lit candles) on the product.
- Keep the product away from direct sunlight, an open fire or other heat sources.
- If using a power adapter for power supply, please use a supported power adapter that has CCC certification.

Making Connections

USB Connection

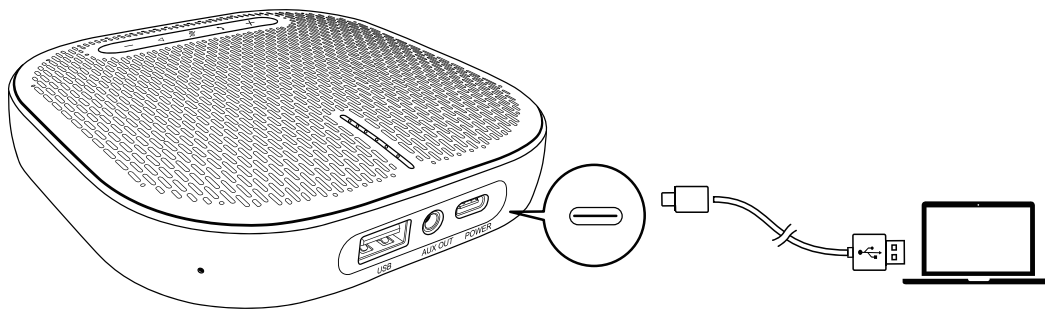

Warning: Do not connect the USB cable to a cellphone.

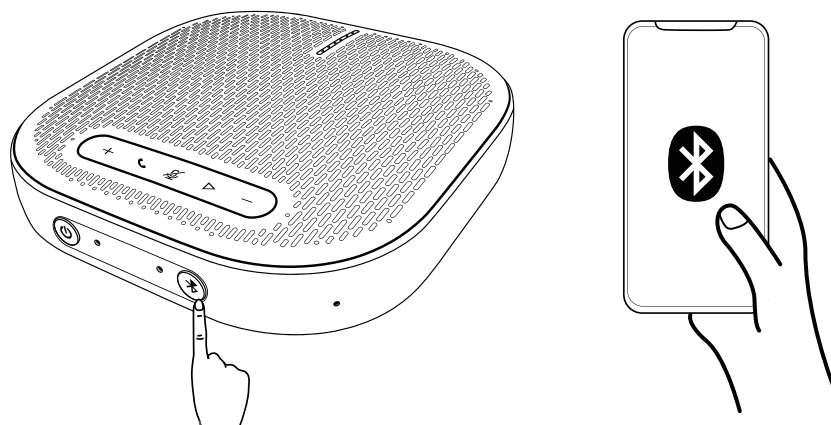

Bluetooth Connection

When the speakerphone is powered on for the first time, it will automatically enter Bluetooth pairing mode.



	Press once	Enter pairing mode
	Blue indicator is flashing	Bluetooth pairing
	Blue indicator is always on	Bluetooth connected

NOTE:

- Every time the speakerphone is powered on, it will automatically connect to previously connected devices (if available).
- To disconnect the Bluetooth connection, press the Bluetooth button again.
- When entering Bluetooth pairing mode, if there is no device paired with VB-AUD-201 the indicator light will stop flashing and turn off after three minutes. If you want to pair another Bluetooth device, please press the pair button again.

Audio Output

Connect an external speaker to the **AUX** jack of the speakerphone with an AUX cable (not provided). The audio will be played through the external speaker.

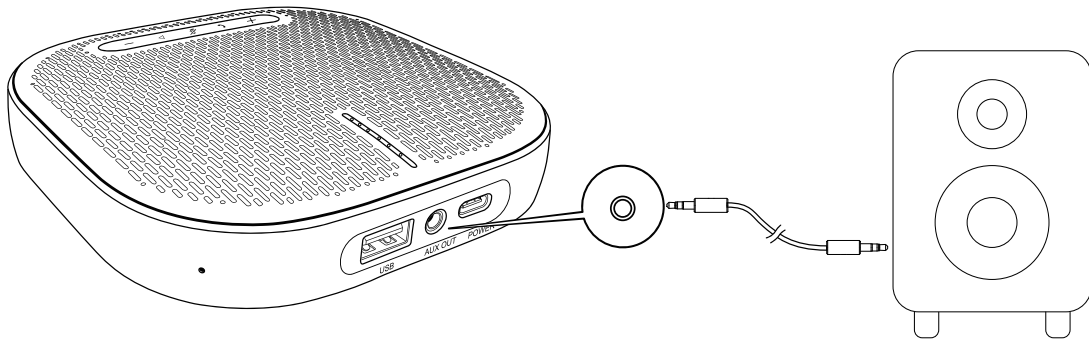



Using the Speakerphone

Powering On/Off

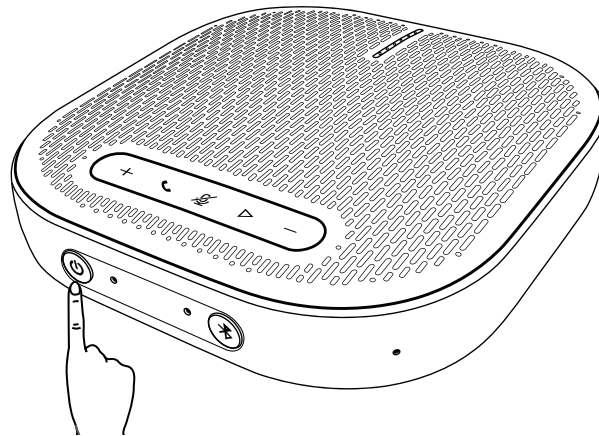
1. Press and hold the power button for two (2) seconds to turn on the power; the **Status Indicator** will light up from top to bottom then turn off.
2. Press and hold the power button for two (2) seconds to turn off the power; the **Status Indicator** will light up from bottom to top then turn off.



Power Indicator Status

	White indicator is always on	Power is on
	Indicator is off	Power is off

NOTE:

- After the speakerphone is connected to a computer, it will automatically power on.
- After 30 minutes of no operation or power supply, the speakerphone will automatically power off.

Button Control

+/-	Press or hold	Volume up/down
☎	Press	Answer/end calls
	Press and hold for 2 seconds	Refuse calls
🔇	Press	Turn the microphone off/on
▶	Press	Play/pause music
	Double click/Triple click	Double click: Next track Triple click: Previous track
	Press and hold for 2 seconds	Switch Bluetooth and USB audio source

Status LED Indicator

White indicator is on for 2 seconds	The USB cable has been connected to a computer
Blue indicator is always on	Calling
The blue LED indicators will move to the bottom with increasing levels and to the top with decreasing levels	Turn volume up or down.
Turns red	Mute
Green indicator is on	Press the power button to check the battery level

Charging

Charging the Speakerphone

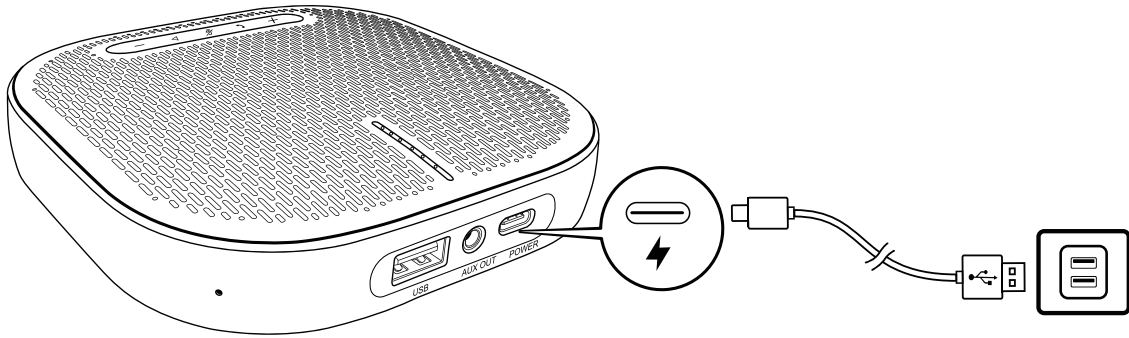

Power Indicator Status

Red indicator is always on	Currently charging
White indicator is always on	Fully charged
Red indicator is flashing	Low battery

Charging External Equipment

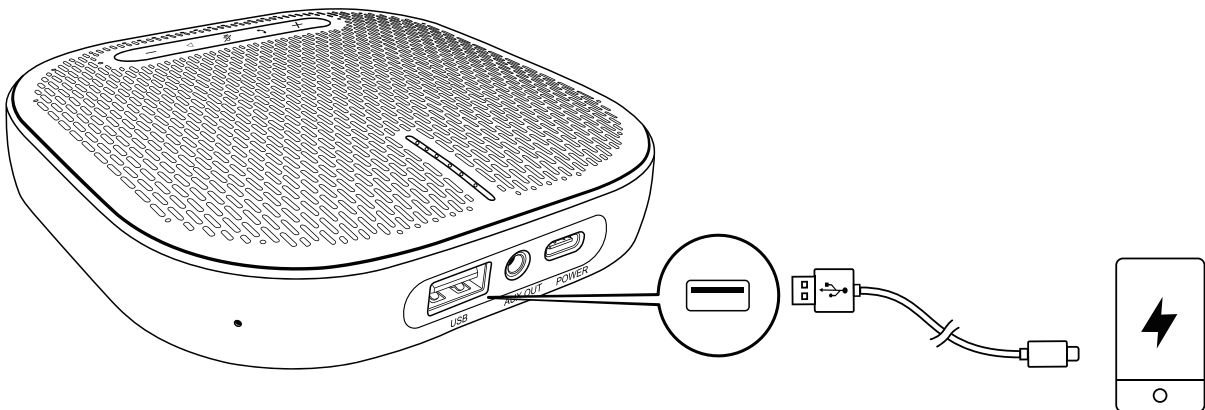

NOTE:

- If the speakerphone is powered off or charging, charging output is not available.
- If the remaining battery of the speakerphone is less than 10%, charging output is not available.

Troubleshooting

If you experience a problem with your conference speakerphone, refer to the following troubleshooting guide. If a problem persists, contact the service center.

Problem or Issue	Possible Solutions
Why is my conference speakerphone not working?	<p><u>Check the device battery status</u></p> <p>Connect to a computer or USB power source with a USB cable and check the power indicator status:</p> <ul style="list-style-type: none">• White indicator is on: Fully charged• Red indicator is flashing: Low battery (needs to be charged immediately) <p><u>Check if the device is connected correctly</u></p> <p>Check your mobile device's Bluetooth menu and delete/forget the VB-AUD-201_XXXX. Re-connect the VB-AUD-201_XXXX to your Bluetooth device.</p>
Why does my conference speakerphone keep cutting out?	<p>Too much distance between the conference speakerphone and the connected device can cause dropped connections.</p> <p>The maximum range for VB-AUD-201 is 20 feet/6 meters. Try moving closer to the device you are connected to. And check the specifications on your connected device to see how close you need to be for maximum connectivity.</p>

Specifications

Item	Category	Specifications
Model	VB-AUD-201	
Name	ViewSonic Converse	
Meeting Capacity	Area Coverage	15-30m ² , 160-320 ft ²
	Number of Participants	6-12 attendees
	Connection Mode	USB 2.0 (VID:0543 / PID: A017), Bluetooth 5.0
Microphone	Microphone Type	Omnidirectional microphone
	Microphone Array	A circular array of built-in four omnidirectional microphones, 360°pick-up
	Distance	6m / 20 ft
	Frequency Response	100Hz~8kHz
	SNR	65dB
Speaker	Speaker Type	Full frequency speaker
	Sensitivity	88 dB SPL (in the range of 0.5 m)
	Rate of Power	Maximum: 5W; Effective: 3W;
	Frequency Response	Call mode: 150Hz ~ 8kHz; Music mode: 20Hz ~ 20kHz
	Volume	84dBA (in the range of 1m)
Audio Frequency	Audio Features	32K sampling rate, high-definition broadband audio, full-duplex voice
	USB Protocol	Supports UAC 2.0
	Echo Cancellation	Supported
	Noise Suppression	Supported
	Gain Control	Supported
Connection Mode	Wireless	Built-in Bluetooth data communication (Bluetooth 5.0). Supports AVRCP,A2DP,HFP and SBC CODEC etc.
	USB	USB data communication, audio input/ call
	Audio	AUX output, Connect to speaker through 3.5mm audio cable for music playback
	Power	(1) Input: USB Type-C interface; External power supply supplies power to VB-AUD-201 device through USB Type-C interface.
		(2) Output: USB Type-A interface. VB-AUD-201 can reverse charge peripherals such as mobile phones through USB Type-A interface.
Button	Touch button (mute button with light indicator)	

Item	Category	Specifications
Environment Condition	Rechargeable Battery	Battery specification: 6500mAh; Full charge time: 4 hours (5V/2A); Maximum charging current: 2.1A; Duration: 24 hours;
	Dimensions	4.88 x 4.88 x 1.26(inch) 124 x 124 x 32(mm) (without packaging)
	Weight	0.75 lbs/0.34 kg (Net)
	Working Temperature	Temperature: 0°C ~ 40°C (working state), -40°C ~ 60°C (non-working state) Relative humidity: 45% ~ 90% (working state), 30% ~ 90% (non-working state)
Certification	Safety	LVD
	EMC	FCC, CE EMC
	Wireless	FCC ID, IC ID, CE RED
	Battery	UN38.3, IEC62133-2
	Adapter	NA
Accessories		1. Carrying case x 1 2. USB Type-C Cable (Male) to USB Type-A cable (Male) 1M x 1 3. Quick Start Guide x 1
Power	Power Source	5V / 2A (USB power supply)
	Power Consumption	10W
Operating Conditions	Temperature	32°F to 104°F (0°C to 40°C)
	Humidity	45% to 90% Non-Condensing
Storage Conditions	Temperature	-40°F to 140°F (-40°C to +60°C)
	Humidity	30% to 90% Non-Condensing

Regulatory and Service Information

Compliance Information

This section addresses all connected requirements and statements regarding regulations. Confirmed corresponding applications shall refer to nameplate labels and relevant markings on the unit.

FCC Compliance Statement

This device complies with part 15 of FCC Rules. Operation is subject to the following two conditions: (1) this device may not cause harmful interference, and (2) this device must accept any interference received, including interference that may cause undesired operation. This equipment has been tested and found to comply with the limits for a Class B digital device, pursuant to part 15 of the FCC Rules.

These limits are designed to provide reasonable protection against harmful interference in a residential installation. This equipment generates, uses, and can radiate radio frequency energy, and if not installed and used in accordance with the instructions, may cause harmful interference to radio communications. However, there is no guarantee that interference will not occur in a particular installation. If this equipment does cause harmful interference to radio or television reception, which can be determined by turning the equipment off and on, the user is encouraged to try to correct the interference by one or more of the following measures:

- Reorient or relocate the receiving antenna.
- Increase the separation between the equipment and receiver.
- Connect the equipment into an outlet on a circuit different from that to which the receiver is connected.
- Consult the dealer or an experienced radio/TV technician for help.

Warning: You are cautioned that changes or modifications not expressly approved by the party responsible for compliance could void your authority to operate the equipment.

FCC Radiation Exposure Statement

This equipment complies with FCC radiation exposure limits set forth for an uncontrolled environment. End users must follow the specific operating instructions for satisfying RF exposure compliance.

This transmitter must not be co-located or operating in conjunction with any other antenna or transmitter. This equipment should be installed and operated with a minimum distance of 20 centimeters between the radiator and your body.

The users manual or instruction manual for an intentional or unintentional radiator shall caution the user that changes or modifications not expressly approved by the party responsible for compliance could void the user's authority to operate the equipment.

Industry Canada Statement Compliance

CAN ICES-003(B) / NMB-003(B)

IC Warning Statement

This device complies with Industry Canada license- exempt RSS standard(s). Operation is subject to the following two conditions: (1) this device may not cause interference, and (2) this device must accept any interference, including interference that may cause undesired operation of the device.

Le présent appareil est conforme aux CNR d'Industrie Canada applicables aux appareils radio exempts de licence. L'exploitation est autorisée aux deux conditions suivantes : (1) l'appareil ne doit pas produire de brouillage, et (2) l'utilisateur de l'appareil doit accepter tout brouillage radioélectrique subi, même si le brouillage est susceptible d'en compromettre le fonctionnement.

Country Code Statement

For product available in the USA/Canada market, only channel 1~11 can be operated. Selection of other channels is not possible.

Pour les produits disponibles aux États-Unis/Canada du marché, seul le canal 1 à 11 peuvent être exploités. Sélection d'autres canaux n'est pas possible.

IC Radiation Exposure Statement

This equipment complied with IC RSS-102 radiation exposure limits set forth for an uncontrolled environment. This equipment should be installed and operated with minimum distance 20cm between the radiator & your body. The device for the band 5150-5825 MHz is only for indoor usage to reduce potential for harmful interference to co-channel mobile satellite systems.

Cet équipement est conforme aux limites d'exposition aux rayonnements IC établies pour un environnement non contrôlé. Cet équipement doit être installé et utilisé avec un minimum de 20cm de distance entre la source de rayonnement et votre corps. Les dispositifs fonctionnant dans la bande 5150-5825 MHz sont réservés uniquement pour une utilisation à l'intérieur afin de réduire les risques de brouillage préjudiciable aux systèmes de satellites mobiles utilisant les mêmes canaux.

CE Conformity for European Countries



The device complies with the EMC Directive 2014/30/EU and Low Voltage Directive 2014/35/EU. Ecodesign Directive 2009/125/EC and Radio Equipment Directive 2014/53/EU.

The following information is only for EU-member states:

The mark shown to the right is in compliance with the Waste Electrical and Electronic Equipment Directive 2012/19/EU (WEEE). The mark indicates the requirement NOT to dispose of the equipment as unsorted municipal waste, but use the return and collection systems according to local law.



If the batteries, accumulators and button cells included with this equipment, display the chemical symbol Hg, Cd, or Pb, then it means that the battery has a heavy metal content of more than 0.0005% Mercury or more than, 0.002% Cadmium, or more than 0.004% Lead.

Declaration of RoHS2 Compliance

This product has been designed and manufactured in compliance with Directive 2011/65/EU of the European Parliament and the Council on restriction of the use of certain hazardous substances in electrical and electronic equipment (RoHS2 Directive) and is deemed to comply with the maximum concentration values issued by the European Technical Adaptation Committee (TAC) as shown below:

Substance	Proposed Maximum Concentration	Actual Concentration
Lead (Pb)	0.1%	< 0.1%
Mercury (Hg)	0.1%	< 0.1%
Cadmium (Cd)	0.01%	< 0.01%
Hexavalent Chromium (Cr6 ⁺)	0.1%	< 0.1%
Polybrominated biphenyls (PBB)	0.1%	< 0.1%
Polybrominated diphenyl ethers (PBDE)	0.1%	< 0.1%
Bis (2-ethylhexyl) phthalate (DEHP)	0.1%	< 0.1%
Butyl benzyl phthalate (BBP)	0.1%	< 0.1%
Dibutyl phthalate (DBP)	0.1%	< 0.1%
Diisobutyl phthalate (DIBP)	0.1%	< 0.1%

Certain components of products as stated above are exempted under the Annex III of the RoHS2 Directives as noted below:

- Copper alloy containing up to 4% lead by weight.
- Lead in high melting temperature type solders (i.e. lead-based alloys containing 85% by weight or more lead).
- Electrical and electronic components containing lead in a glass or ceramic other than dielectric ceramic in capacitors, e.g. piezoelectronic devices, or in a glass or ceramic matrix compound.
- Lead in dielectric ceramic in capacitors for a rated voltage of 125V AC or 250V DC or higher.

For EU users, please contact us for any safety/accident issue experienced with this product:

ViewSonic Europe Limited



Haaksbergweg 75
1101 BR Amsterdam
Netherlands



+31 (0) 650608655



EPREL@viewsoniceurope.com



<https://www.viewsonic.com/eu/>

Copyright Information

Copyright© ViewSonic® Corporation, 2022. All rights reserved.

Macintosh and Power Macintosh are registered trademarks of Apple Inc.

Microsoft, Windows, and the Windows logo are registered trademarks of Microsoft Corporation in the United States and other countries.

ViewSonic®, the three birds logo, OnView, ViewMatch, and ViewMeter are registered trademarks of ViewSonic® Corporation.

VESA is a registered trademark of the Video Electronics Standards Association. DPMS, DisplayPort, and DDC are trademarks of VESA.

Disclaimer: ViewSonic® Corporation shall not be liable for technical or editorial errors or omissions contained herein; nor for incidental or consequential damages resulting from furnishing this material, or the performance or use of this product.

In the interest of continuing product improvement, ViewSonic® Corporation reserves the right to change product specifications without notice. Information in this document may change without notice.

No part of this document may be copied, reproduced, or transmitted by any means, for any purpose without prior written permission from ViewSonic® Corporation.

Customer Service

For technical support or product service, see the table below or contact your reseller.

NOTE: You will need the product's serial number.

Country/ Region	Website	Country/ Region	Website
Asia Pacific & Africa			
Australia	www.viewsonic.com/au/	Bangladesh	www.viewsonic.com/bd/
中国 (China)	www.viewsonic.com.cn	香港 (繁體中文)	www.viewsonic.com/hk/
Hong Kong (English)	www.viewsonic.com/hk-en/	India	www.viewsonic.com/in/
Indonesia	www.viewsonic.com/id/	Israel	www.viewsonic.com/il/
日本 (Japan)	www.viewsonic.com/jp/	Korea	www.viewsonic.com/kr/
Malaysia	www.viewsonic.com/my/	Middle East	www.viewsonic.com/me/
Myanmar	www.viewsonic.com/mm/	Nepal	www.viewsonic.com/np/
New Zealand	www.viewsonic.com/nz/	Pakistan	www.viewsonic.com/pk/
Philippines	www.viewsonic.com/ph/	Singapore	www.viewsonic.com/sg/
臺灣 (Taiwan)	www.viewsonic.com/tw/	ประเทศไทย	www.viewsonic.com/th/
Việt Nam	www.viewsonic.com/vn/	South Africa & Mauritius	www.viewsonic.com/za/
Americas			
United States	www.viewsonic.com/us	Canada	www.viewsonic.com/us
Latin America	www.viewsonic.com/la		
Europe			
Europe	www.viewsonic.com/eu/	France	www.viewsonic.com/fr/
Deutschland	www.viewsonic.com/de/	Қазақстан	www.viewsonic.com/kz/
Россия	www.viewsonic.com/ru/	España	www.viewsonic.com/es/
Türkiye	www.viewsonic.com/tr/	Україна	www.viewsonic.com/ua/
United Kingdom	www.viewsonic.com/uk/		

Limited Warranty

ViewSonic® Conference Speakerphone

What the warranty covers:

ViewSonic® warrants its products to be free from defects in material and workmanship during the warranty period. If a product proves to be defective in material or workmanship during the warranty period, ViewSonic® will, at its sole option, and as your sole remedy, repair or replace the product with a similar product. Replacement Product or parts may include remanufactured or refurbished parts or components. The repair or replacement unit or parts or components will be covered by the balance of the time remaining on the customer's original limited warranty and the warranty period will not be extended. ViewSonic® provides no warranty for any third-party software whether included with the product or installed by the customer, installation of any unauthorized hardware parts or components (e.g. Projector Lamps). (Please refer to: "What the warranty excludes and does not cover" section).

Who the warranty protects:

This warranty is valid only for the first consumer purchaser.

What the warranty excludes and does not cover:

- Any product on which the serial number has been defaced, modified, or removed.
- Damage, deterioration, or malfunction resulting from:
 - » Accident, misuse, neglect, fire, water, lightning, or other acts of nature, unauthorized product modification, or failure to follow instructions supplied with the product.
 - » Repair or attempted repair by anyone not authorized by ViewSonic®.
 - » Damage to or loss of any programs, data, or removable storage media.
 - » Normal wear and tear.
 - » Removal or installation of the product.
- Software or data loss occurring during repair or replacement.
- Any damage of the product due to shipment.
- Causes external to the product, such as electric power fluctuations or failure.
- Use of supplies or parts not meeting ViewSonic's specifications.
- Failure of owner to perform periodic product maintenance as stated in the User Guide.
- Any other cause which does not relate to a product defect.

- Damage caused by static (non-moving) images displayed for lengthy periods of time (also referred to as image burn-in).
- Software - Any third-party software included with the product or installed by the customer.
- Hardware/Accessories/Parts/Components – Installation of any unauthorized hardware, accessories, consumable parts or components (e.g. Projector Lamps).
- Damage to, or abuse of, the coating on the surface of the display through inappropriate cleaning as described in the product User Guide.
- Removal, installation, and set-up service charges, including wall-mounting of the product.

How to get service:

- For information about receiving service under warranty, contact ViewSonic® Customer Support (Please refer to the “Customer Service” page). You will need to provide your product’s serial number.
- To obtain warranty service, you will be required to provide: (a) the original dated sales slip, (b) your name, (c) your address, (d) a description of the problem, and (e) the serial number of the product.
- Take or ship the product, freight prepaid, in the original container to an authorized ViewSonic® service center or ViewSonic®.
- For additional information or the name of the nearest ViewSonic® service center, contact ViewSonic®.

Limitation of implied warranties:

There are no warranties, express or implied, which extend beyond the description contained herein including the implied warranty of merchantability and fitness for a particular purpose.

Exclusion of damages:

ViewSonic's liability is limited to the cost of repair or replacement of the product. ViewSonic® shall not be liable for:

- Damage to other property caused by any defects in the product, damages based upon inconvenience, loss of use of the product, loss of time, loss of profits, loss of business opportunity, loss of goodwill, interference with business relationships, or other commercial loss, even if advised of the possibility of such damages.
- Any other damages, whether incidental, consequential or otherwise.
- Any claim against the customer by any other party.
- Repair or attempted repair by anyone not authorized by ViewSonic®.

Effect of state law:

This warranty gives you specific legal rights, and you may also have other rights which vary from state to state. Some states do not allow limitations on implied warranties and/or do not allow the exclusion of incidental or consequential damages, so the above limitations and exclusions may not apply to you.

Sales outside the U.S.A. and Canada:

For warranty information and service on ViewSonic® products sold outside of the U.S.A. and Canada, contact ViewSonic® or your local ViewSonic® dealer.

The warranty period for this product in mainland China (Hong Kong, Macao, and Taiwan Excluded) is subject to the terms and conditions of the Maintenance Guarantee Card.

For users in Europe and Russia, full details of warranty provided can be found at: <http://www.viewsonic.com/eu/> under "Support/Warranty Information".

Mexico Limited Warranty

ViewSonic® Conference Speakerphone

What the warranty covers:

ViewSonic® warrants its products to be free from defects in material and workmanship, under normal use, during the warranty period. If a product proves to be defective in material or workmanship during the warranty period, ViewSonic® will, at its sole option, repair or replace the product with a like product. Replacement product or parts may include remanufactured or refurbished parts or components & accessories.

Who the warranty protects:

This warranty is valid only for the first consumer purchaser.

What the warranty excludes and does not cover:

- Any product on which the serial number has been defaced, modified or removed.
- Damage, deterioration, or malfunction resulting from:
 - » Accident, misuse, neglect, fire, water, lightning, or other acts of nature, unauthorized product modification, unauthorized attempted repair, or failure to follow instructions supplied with the product.
 - » Causes external to the product, such as electrical power fluctuations or failure.
 - » Use of supplies or parts not meeting ViewSonic®'s specifications.
 - » Normal wear and tear.
 - » Any other cause which does not relate to a product defect.
- Any product exhibiting a condition commonly known as “image burn-in” which results when a static image is displayed on the product for an extended period of time.
- Removal, installation, insurance, and set-up service charges.

How to get service:

For information about receiving service under warranty, contact ViewSonic® Customer Support (Please refer to the attached “Customer Service” page). You will need to provide your product’s serial number, so please record the product information in the space provided below on your purchase for your future use. Please retain your receipt of proof of purchase to support your warranty claim.

For Your Records

Product Name: _____ Model Number: _____
Document Number: _____ Serial Number: _____
Purchase Date: _____ Extended Warranty Purchase? _____(Y/N)
If so, what date does warranty expire? _____

- To obtain warranty service, you will be required to provide (a) the original dated sales slip, (b) your name, (c) your address, (d) a description of the problem, and (e) the serial number of the product.
- Take or ship the product, in the original container packaging, to an authorized ViewSonic® service center.
- Round trip transportation costs for in-warranty products will be paid by ViewSonic®.

Limitation of implied warranties:

There are no warranties, express or implied, which extend beyond the description contained herein including the implied warranty of merchantability and fitness for a particular purpose.

Exclusion of damages:

ViewSonic®’s liability is limited to the cost of repair or replacement of the product. ViewSonic® shall not be liable for:

- Damage to other property caused by any defects in the product, damages based upon inconvenience, loss of use of the product, loss of time, loss of profits, loss of business opportunity, loss of goodwill, interference with business relationships, or other commercial loss, even if advised of the possibility of such damages.
- Any other damages, whether incidental, consequential or otherwise.
- Any claim against the customer by any other party.
- Repair or attempted repair by anyone not authorized by ViewSonic®.

Contact Information for Sales & Authorized Service (Centro Autorizado de Servicio) within Mexico:	
Name, address, of manufacturer and importers: México, Av. de la Palma #8 Piso 2 Despacho 203, Corporativo Interpalmas, Col. San Fernando Huixquilucan, Estado de México Tel: (55) 3605-1099 http://www.viewsonic.com/la/soporte/index.htm	
NÚMERO GRATIS DE ASISTENCIA TÉCNICA PARA TODO MÉXICO: 001.866.823.2004	
Hermosillo: Distribuciones y Servicios Computacionales SA de CV. Calle Juarez 284 local 2 Col. Bugambilias C.P: 83140 Tel: 01-66-22-14-9005 E-Mail: disc2@hmo.megared.net.mx	Villahermosa: Compumantenimientos Garantizados, S.A. de C.V. AV. GREGORIO MENDEZ #1504 COL, FLORIDA C.P. 86040 Tel: 01 (993) 3 52 00 47 / 3522074 / 3 52 20 09 E-Mail: compumantenimientos@prodigy.net.mx
Puebla, Pue. (Matriz): RENTA Y DATOS, S.A. DE C.V. Domicilio: 29 SUR 721 COL. LA PAZ 72160 PUEBLA, PUE. Tel: 01(52).222.891.55.77 CON 10 LINEAS E-Mail: datos@puebla.megared.net.mx	Veracruz, Ver.: CONEXION Y DESARROLLO, S.A DE C.V. Av. Americas # 419 ENTRE PINZÓN Y ALVARADO Fracc. Reforma C.P. 91919 Tel: 01-22-91-00-31-67 E-Mail: gacosta@qplus.com.mx
Chihuahua: Soluciones Globales en Computación C. Magisterio # 3321 Col. Magisterial Chihuahua, Chih. Tel: 4136954 E-Mail: Cefeo@soluglobales.com	Cuernavaca: Compusupport de Cuernavaca SA de CV Francisco Leyva # 178 Col. Miguel Hidalgo C.P. 62040, Cuernavaca Morelos Tel: 01 777 3180579 / 01 777 3124014 E-Mail: aquevedo@compusupportcva.com
Distrito Federal: QPLUS, S.A. de C.V. Av. Coyoacán 931 Col. Del Valle 03100, México, D.F. Tel: 01(52)55-50-00-27-35 E-Mail : gacosta@qplus.com.mx	Guadalajara, Jal.: SERVICRECE, S.A. de C.V. Av. Niños Héroes # 2281 Col. Arcos Sur, Sector Juárez 44170, Guadalajara, Jalisco Tel: 01(52)33-36-15-15-43 E-Mail: mmiranda@servicrece.com
Guerrero Acapulco: GS Computación (Grupo Sesicomp) Progreso #6-A, Colo Centro 39300 Acapulco, Guerrero Tel: 744-48-32627	Monterrey: Global Product Services Mar Caribe # 1987, Esquina con Golfo Pérsico Fracc. Bernardo Reyes, CP 64280 Monterrey N.L. México Tel: 8129-5103 E-Mail: aydeem@gps1.com.mx
MERIDA: ELECTROSER Av Reforma No. 403Gx39 y 41 Mérida, Yucatán, México CP97000 Tel: (52) 999-925-1916 E-Mail: rrrb@sureste.com	Oaxaca, Oax.: CENTRO DE DISTRIBUCION Y SERVICIO, S.A. de C.V. Murguía # 708 P.A., Col. Centro, 68000, Oaxaca Tel: 01(52)95-15-15-22-22 Fax: 01(52)95-15-13-67-00 E-Mail: gpotai2001@hotmail.com
Tijuana: STD Av Ferrocarril Sonora #3780 L-C Col 20 de Noviembr Tijuana, Mexico	FOR USA SUPPORT: ViewSonic® Corporation 381 Brea Canyon Road, Walnut, CA. 91789 USA Tel: 800-688-6688 E-Mail: http://www.viewsonic.com



ViewSonic®