



2022 CATALOG



LED • CONTROLS • HID

VALUE • FLEXIBILITY • PERFORMANCE



CONTENTS

Introduction2-3

LED Interior Luminaires

Highbays5-12
Troffers13-14
Panels15-18
Vapor tight19
Recessed downlights20
Wrap fixture21
Linear strip fixtures22
Temporary lighting23

LED Exterior Luminaires

Wallpacks25-26
Floods27-29
Area30-33
Surface Mount Canopy34
Parking Garage35-36
Gas Station Canopy37
Recessed Canopy38
Tennis Lighting40-41

LED Lamps

Retrofit Lamps43-45

Sensors, Controls and Poles

Sensors and Controls47-49
Area Lighting Pole Options51-59
Accessories for Pole Options60-61

HID Products

Metal Halide Lamps63-64
SPL Long Life Lamps65
Sports Lighting Lamps65
Energy Master Lamps65
Natural White Lamps66
White-Lux HPS Retrofit66
Double-Ended Lamps66
High Pressure Sodium Lamps67
HID Ballast Kits68
Capacitors68
Replacement Ignitors68

HID Technical Information69-72

Warranty Information73

Venture Lighting is a worldwide innovator, manufacturer and supplier of energy efficient lighting materials, components, systems, fixtures and controls. Since being founded in 1983 and becoming part of Advanced Lighting Technologies in 1995, Venture Lighting has always been a pioneer in light source technologies. An advocate for industry terms like “LPW” and “Lumen Maintenance”, Venture Lighting continues to be a leader in the lighting industry.

An Innovation Leader:

- Full line of LED lamps, fixtures and controls
- Low glare
- High efficacy
- Thermal management
- Precise optics
- Fixtures that are application adaptable

Customers are assured:

- The very best technology
- The highest level of service
- Ease of working with
- Dedicated technical and customer support

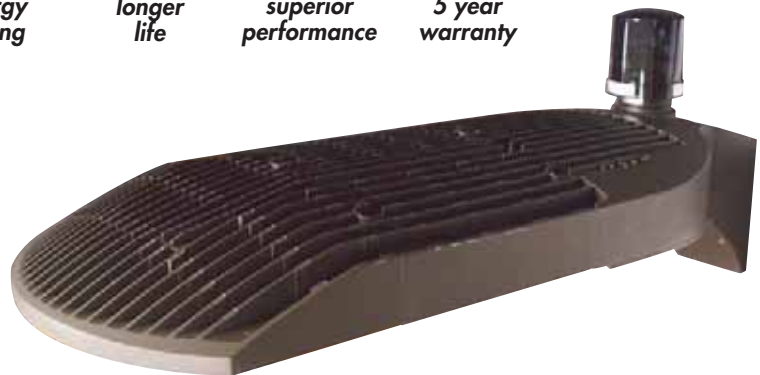

Founded in 1983, Venture has built a reputation as the market leader in LED lighting and Metal Halide technology. We are innovators, manufacturers and suppliers of energy-efficient luminaires, lighting components and control systems.

Venture continuously strives to offer its customers, large and small, the best lighting solutions coupled with the very best service and support. Venture has built strong customer relationships that have lasted through the years because of its dynamic and broad product lines combined with a level of customer service and technical support teams unequalled in the industry.

With over 35 years of pioneering light source technologies, Venture Lighting is an innovation-driven designer, manufacturer and marketer of energy efficient lighting products, and services. Transforming the high intensity discharge lighting industry, Venture Lighting's superb quality, world-class service and outstanding technical support continues in the very best LED lighting solutions paired with a best-in-class wireless control system and the highest level of dedicated technical and customer support on all of their products.

Visit VentureLighting.com to find out more about Venture Lighting.



ASSEMBLING AT VENTURE LIGHTING, NORTH AMERICA

Venture Lighting is assembling its LED luminaires in the U.S.A. Currently, Venture Lighting is assembling six different LED product families: Modern highbays, Linear highbays, Low watt Environ area lighting, VFlood area lighting and SafeLit parking garage lighting and Strips. Venture Lighting has always strived to exceed customer expectations, Venture believes that assembling luminaires in the USA will allow Venture to provide customers with more options and faster delivery times.



ASSEMBLED IN THE
 **U.S.A.**

Visit Venture's YouTube Channel to watch a short video of the production of the Modern LED Highbay in Glenwillow, Ohio.

The Results

- Faster delivery time
- American quality and know-how
- More factory-installed options
- Made-to-order specifications
- Building for a better, brighter future



INTERIOR LIGHTING SOLUTIONS

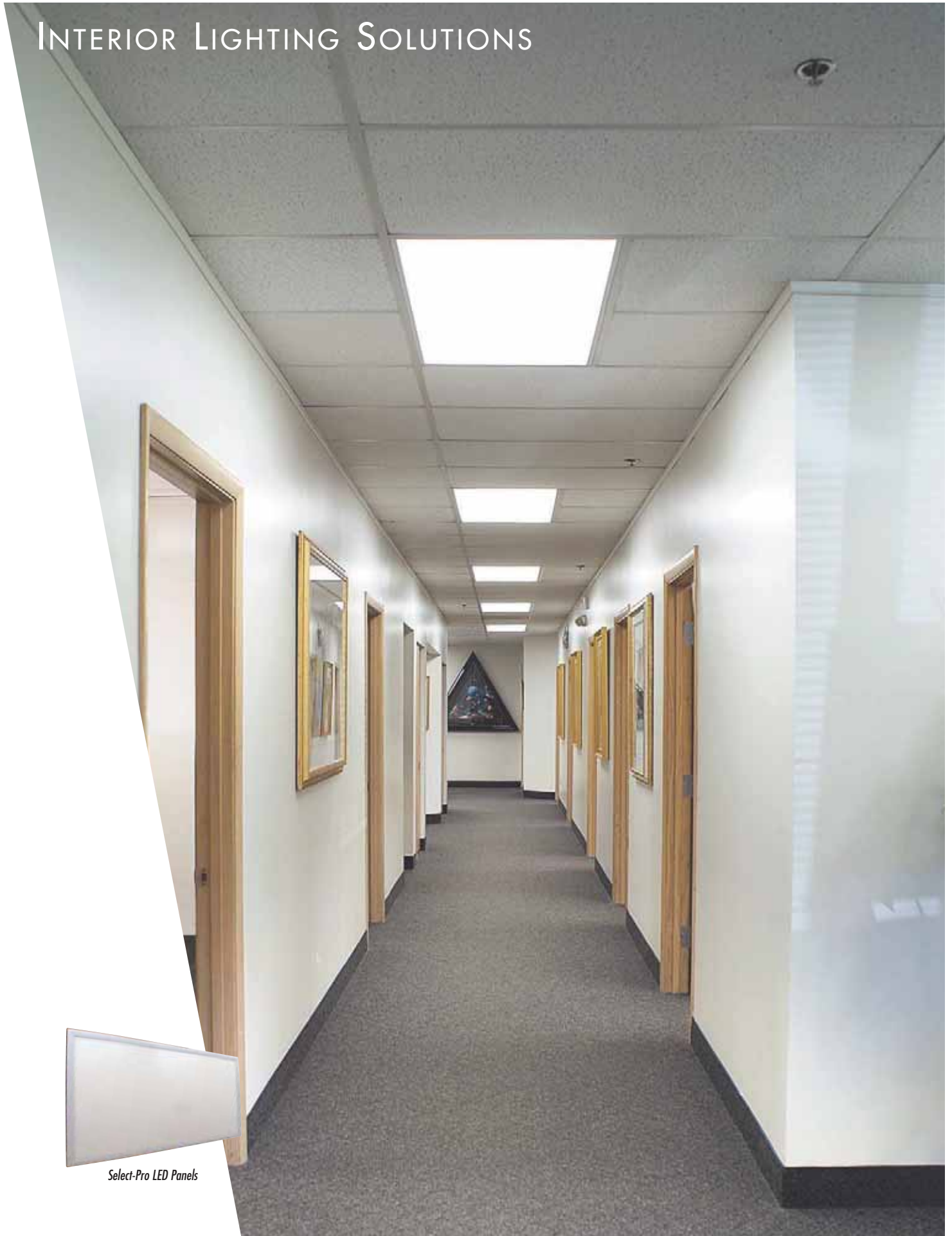

Select-Pro LED Panels



LED Highbay Lighting

Select-Pro Modern Highbay

120-277V

Model Number	4000K			5000K			CRI	Beam Angle	Lumen Maint. @50,000 hours [†]	Calc. L70@25°C Amb.(hrs) [†]	Fixt. Color	DLC Qualified	DLC Model Number
	Wattage	Lumen Output	LPW	Lumen Output	LPW								
HB48133	240	34800	145	32400	135	≥80	90°	90.25%	174,000	White	Premium	HBRS-240/200/180WS1BT2A1-WH40/50KWR	
	200	29000	145	27000	135								
	180	26100	145	24300	135								
HB32609	150	21750	145	20250	135	≥80	90°	90.25%	174,000	White	Premium	HBRS-150/120/100WS1BT2A1-WH40/50KWR	
	120	17400	145	16200	135								
	100	14500	145	13500	135								



Benefits and Features

- Gloss white powder coat finish
- High quality Sosen Driver
- Lumileds LEDs
- CCT and Power Selectable for application flexibility
- cULus Listed
- IP69K Rated
- NSF Certified - Splash Zone
- Screw-in microwave sensor ready
- Polycarbonate circular ribbed lens for glare reduction
- Multiple mounting options available
- Aluminum and PC reflector options



Select-Pro Modern Highbay shown with screw-in sensor



CCT/Wattage Field Adjustable Switches

Accessories

- BB34980** - 30W Battery Backup
- PH53207** - Screw-in programmable microwave sensor
- PH52186** - M/P/D Sensor handheld programmer
- SP12714** - Remote mount surge protector

Factory installed Indoor and NSF certified watertight plug options are available, see spec sheets for details



NEMA L5-15P
For 120V Input



NEMA L18-20P
For 208V Input



NEMA L6-15P
For 240V Input



NEMA L7-15P
For 277V Input

Accessories for 100-150W

- LN31732** - 120 degree clear PC lens
- LN31734** - 120 degree frosted PC lens
- RF14210** - PC reflector
- RF14230** - Aluminum reflector
- AC27385** - Surface mount bracket, white
- AC27485** - 3/4" NPT Pendant adaptor (M10)

Accessories for 180-240W

- LN31736** - 120 degree clear PC lens 240W
- LN31738** - 120 degree frosted PC lens 240W
- RF14220** - PC reflector
- RF14240** - Aluminum reflector
- AC27390** - Surface mount bracket, white
- AC27490** - 3/4" NPT Pendant adaptor (M12)



IP69K



Note: * NSF Certified for Splash Zone, not for food contact



LED HIGHBAY LIGHTING

Modern

120-277V

Wattage	Order Code	Lumen Output	Color Temp.	CRI	Beam Angle	Lumen Maint. @50,000 hours [†]	Calc. L70@25°C Amb.(hrs) [†]	Fig.	Fixt. Color	DLC Qualified	Replaces Existing HID Wattages	DLC Model Number
150W	HB71452	15750	4000K	80	90°	92%	230,000	A	White	-	400W	-
150W	HB95488	19500	5000K	80	90°	92%	230,000	A	White	-	400W	-
200W	HB20943*	21000	4000K	80	90°	92%	223,000	B	White	-	750W	-
200W	HB22920*	26000	5000K	80	90°	92%	223,000	B	White	-	750W	-
300W	HB31479	38800	4000K	80	90°	77%	68,000	C	White	-	1000W	-
300W	HB41782	38800	5000K	80	90°	77%	68,000	C	White	-	1000W	-

NOTE: † Lumen maintenance data is based on LED testing per IESNA LM-80 and projected per IESNA TM-21

* 200W highbay only available with driver in black color.

Benefits and Features

- 0-10V DC dimming standard
- IP65 Rating
- Multiple beam angle options
- Factory installed sensor options
- Factory installed plug options
- Electrical: 50/60Hz, 120-277V and 347-480V
- CCT: 5000K and 4000K

Dimensions

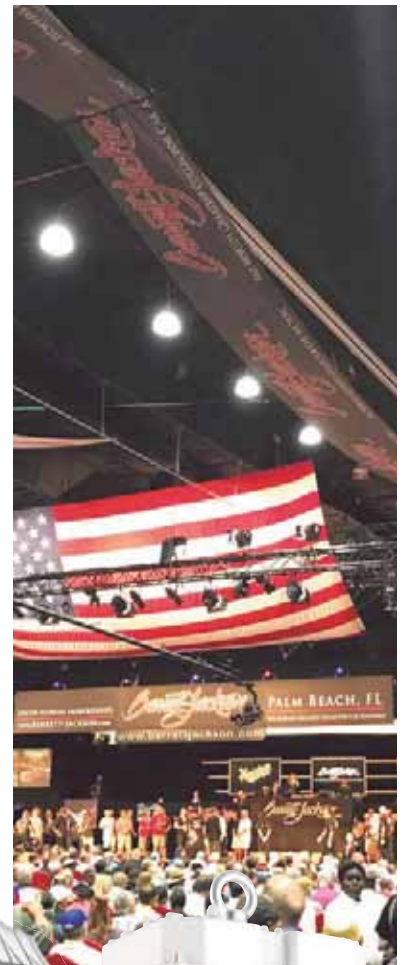
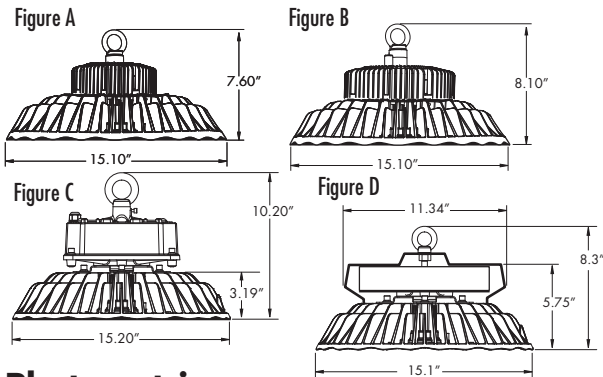

Photometrics

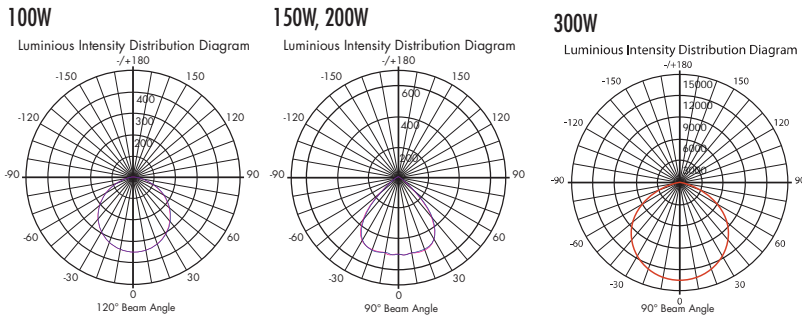

IP65



See Page 7 for Accessories



LED HIGHBAY LIGHTING

Modern

277-480V

Wattage	Order Code	Lumen Output	Color Temp.	CRI	Beam Angle	Lumen Maint. @50,000 hours†	Calc. L70@25°C Amb.(hrs)†	Fixt. Fig.	Color	DLC Qualified	Replaces Existing HID Wattages	DLC Model Number
100W	HB54216	11890	4000K	80	120°	92%	240,000	C	White	-	250W	-
100W	HB19238	12300	5000K	80	120°	92%	240,000	C	White	-	250W	-
150W	HB27813	19000	4000K	80	90°	92%	230,000	C	White	-	400W	-
150W	HB27146	19700	5000K	80	90°	92%	230,000	C	White	-	400W	-
200W	HB41682	24100	4000K	80	90°	92%	223,000	C	White	-	750W	-
200W	HB28334	25400	5000K	80	90°	92%	223,000	C	White	-	750W	-
300W	HB67127	38160	4000K	70+	90°	77%	68,000	D	White	-	1000W	-
300W	HB64152	38700	5000K	70+	90°	77%	68,000	D	White	-	1000W	-

NOTE: † Lumen maintenance data is based on LED testing per IESNA LM-80 and projected per IESNA TM-21



Accessories (Order as separate line items)

Common Accessories for All Modern Fixtures

- PH41623 - Dry/damp rated motion/on-off sensor only (S1) (120-277V)
- PH77409 - Dry/damp rated motion/on-off/photocell/dimming sensor (S2) (120-277V)
- PH21458 - Wet and low temp. rated motion sensor only (S3) (120-277V)
- PH27419 - Wet and low temp. rated motion/photocell/dimming sensor (S4) (120-277V)
- PH48156 - Dry/damp rated motion/on-off sensor only (S1) (277-480V)
- PH52321 - Dry/damp rated motion/on-off/photocell/dimming sensor (S2) (277-480V)
- PH36512 - Wet and low temp. rated motion sensor only (S3) (277-480V)
- PH37415 - Wet and low temp. rated motion/photocell/dimming sensor (S4) (277-480V)

Note: All sensors (S1, S2, S3, and S4) are factory installed. Add suffix ".S#" to the end of the order code for a factory installed sensor.

Factory installed plug options are available, see spec sheets for details



NEMA L5-15P



NEMA L18-20P



NEMA L6-15P



NEMA L7-15P



NEMA L24-20P



NEMA L8-20P

Accessories (Order as separate line items)

Accessories for 100W-200W

- LN13421 - 120° clear tempered glass (for 150W-300W)
- LN13632 - 120° polycarbonate lens
- LN28431 - 50° polycarbonate lens
- LN13492 - Frosted polycarbonate lens
- RF13388 - Aluminum shield
- RF13912 - Acrylic refractor
- AC78196 - Pendant mount kit (White) for ¾" NPT (120-277V)
- AC53904 - Pendant mount kit (White) for ¾" NPT (347-480V)
- AC26546 - Adjustable U-bracket kit (120-277V)
- AC26864 - Adjustable U-bracket kit (277-480V)
- KT14791 - Sensor mount kit (120-277V & 277-480V)

Accessories (Order as separate line items)

Accessories for 300W

- LN13421 - 120° clear tempered glass (for 150W-300W)
- LN13632 - 120° polycarbonate lens
- LN13927 - 60° polycarbonate lens
- LN13492 - Frosted polycarbonate lens
- RF13388 - Aluminum shield
- RF13912 - Acrylic refractor
- AC53904 - Pendant mount kit (White) for ¾" NPT (120-277V)
- AC26864 - Adjustable U-bracket kit (120-277V)
- AC51241 - Surface mount yoke kit (277-480V)
- KT14791 - Sensor mount kit (120-277V)
- AC17648 - Sensor mount Kit (277-480V)



IP65



LED HIGHBAY LIGHTING

VSolution

120-277V

Wattage	Order Code	Lumen Output	Color Temp.	CRI	Beam Angle	Lumen Maint. @50,000 hours†	Calc. L70@25°C Amb.(hrs)†	Fixt. Color	DLC Qualified	Replaces Existing HID Wattages	DLC Model Number
150W	HB43219	21850	5000K	80	90°	89%	155,000	Black	-	400W	-

NOTE: † Lumen maintenance data is based on LED testing per IESNA LM-80 and projected per IESNA TM-21



Benefits and Features

- Efficacy up to 145 lumens per watt
- Electrical: 50/60Hz, 120-277V
- IP65 Rating
- CCT: 5000K
- 0-10V DC dimming standard

Photometrics

150W

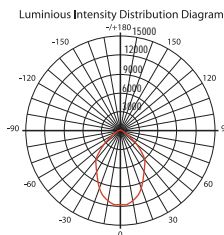

Dimensions

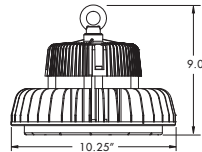

Accessories (Order as separate line items)

- KT12089** - IP65 motion/photocell/dimming sensor with mounting kit (add "-S4" for Factory Installed)
- KT18215** - Adjustable U-Bracket
- AC62148** - Pendant mount kit
- RF50402** - 90° Aluminum reflector
- RF55800** - 16" Polycarbonate reflector
- RF19927** - 16" Clear acrylic reflector
- RF19935** - 16" Diffuse acrylic reflector
- LN28315** - 16" Clear acrylic drop reflector lens (RF63661 required)
- LN28325** - 16" Diffuse acrylic drop reflector lens (RF63661 required)
- RF63661** - 16" Dia. Reflector lens band

Accessories (Order as separate line items)

- LN11476** - 120° Clear tempered glass lens
- LN14399** - 120° Frosted tempered glass lens
- LN17698** - 120° Clear polycarbonate lens
- LN19016** - 60° Polycarbonate lens
- LN15743** - 90° Polycarbonate lens (replacement)

Note: IP65 motion/photocell/dimming sensor is factory installed. Add suffix "-S4" to the end of the order code for a factory installed sensor.
Factory installed plug options are available, see spec sheets for details



IP65



LED LINEAR HIGHBAY LIGHTING

Select-Pro Linear Highbay

120-277V

Model Number	4000K			5000K			CRI	Rated Life Hours	Replaces Existing HID Luminaire	Fixt. Color	DLC Qualified	DLC Model Number
	Wattage	Lumen Output	LPW	Lumen Output	LPW							
HB21925	155	20925	135	21080	136	≥80	50,000	Up to 400W	White	Premium	HBLS2UNV-155/ 130/105-FL/AU2/ F1/A3/B7/SN/EMN	
	130	17550	135	17680	136							
	105	14175	135	14280	136							
HB38124	210	28350	135	28560	136	≥80	50,000	Up to 1000W	White	Premium	HBLS2UNV-210/ 170/155-FL/AU2/ F1/A3/B7/SN/EMN	
	170	22950	135	23120	136							
	155	20925	135	21080	136							



Benefits and Features

- Factory installed battery back-up available
- Screw-in sensor ready
- Versatile and easy to install - pendant or surface mount accessories sold separately
- Frosted lens
- 0-10V DC continuous dimming to 10%
- Rated for damp and dry locations
- Optional wire guard available

Photometrics

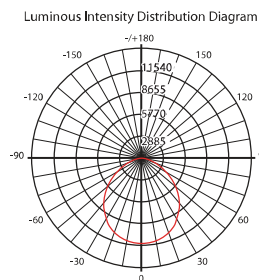

Dimensions

Weight: 11.24 lbs (5.10 kg)

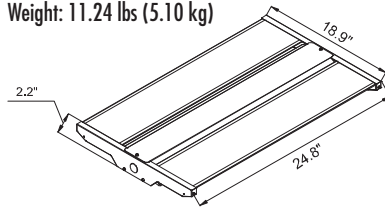

Accessories

- PH86347** - Field installable plug-in photo/motion sensor
- AC86350** - Motion sensor remote control
- KT26750** - Pendant mount kit with hardware
- KT26740** - Surface mount kit
- KT26822** - Wire guard kit with hardware for 105-155W
- KT26824** - Wire guard kit with hardware for 155-210W

Add suffix "-EM" to order code for a factory-installed Battery Backup
 Add suffix "-WP" to order code for a factory-installed 6ft Whip (AC25420)
 Add suffix "-EM-WP" to order code for a factory-installed Battery Backup and a 6ft Whip (AC25418)

Factory installed plug options are available, see spec sheets for details.



NEMA L5-15P



NEMA L18-20P



NEMA L6-15P



NEMA L7-15P



LED LINEAR HIGHBAY LIGHTING

Clear Lens Linear Highbay

347-480V

Wattage	Order Code	Lumen Output	Color Temp.	CRI	Lumens Per Watt	Rated Life (hrs)	Fixture Color	DLC Qualified	DLC Model Number
110W	HB18218	14850	5000K	≥80	135	50,000	White	-	-
320W	HB52168	43300	5000K	≥80	135	50,000	White	-	-

Frosted Lens Linear Highbay

347-480V

Wattage	Order Code	Lumen Output	Color Temp.	CRI	Lumens Per Watt	Rated Life (hrs)	Fixture Color	DLC Qualified	DLC Model Number
320W	HB54791	42050	5000K	≥80	131	50,000	White	-	-



Dimensions

110W: Weight: 10.2 lbs (4.6 kg) 320W: Weight: 28.0 lbs (12.7 kg)

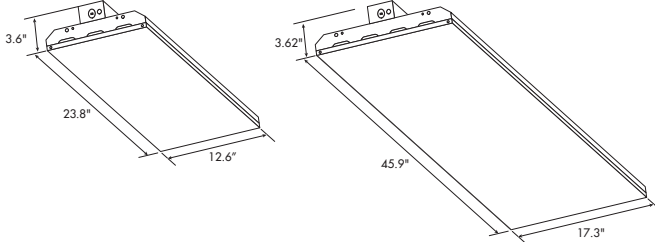

Accessories

- AC24512** - 1 meter chain with S-hooks (2pcs) (replacement)
- PH48156** - Dry/damp rated motion/on-off sensor only (277-480V)
- PH52321** - Dry/damp rated motion/on-off/photocell/dimming sensor (277-480V)
- KT37505** - Pendant mount kit with hardware (white)

Accessories for 110W

- KT37304** - Surface mount kit (white)
- KT42515** - Wire guard kit with hardware

Accessories for 320W

- LN42193** - Frosted Lens for field replacement
- KT41013** - Wire guard kit with hardware
- KT31292** - Surface mount kit (white)
- AC24512** - 1 Meter chain with S-hooks (replacement)

Factory installed accessories:

- Add suffix "-S1" for a MOTION ONLY Sensor; Part # PH48156
- Add suffix "-S2" for a MOTION/DIM/PHOTOCELL Sensor; Part # PH52321
- Add suffix "-S5" for a Bluetooth PIR Sensor
- Add suffix "-EM" for a 17W battery back-up

Factory installed plug and cable options:

- Add suffix "-P6-C" for 120V NEMA L5-15P molded plug with 11ft cable
- Add suffix "-P10-C" for 208V NEMA L18-20P molded plug with 11ft cable
- Add suffix "-P7-C" for 240V NEMA L6-15P molded plug with 11ft cable
- Add suffix "-P8-C" for 277V NEMA L7-15P molded plug with 11ft cable



LED Highbay Lighting

VSplash

120-277V

Wattage	Order Code	Lumen Output	Color Temp.	CRI	Life Hours †	Fixture Color	Dimming Leads	DLC Qualified	Replaces Existing HID Wattage	DLC / NSF Model Number
150W	HB45236	20250	5000K	80	230,000	Gray	External	Premium	400W	HW1-150C-AB
150W	HB41357	20250	5000K	80	230,000	Gray	Internal (capped)	Premium	400W	HW1-150C-AB

NOTE: † Lumen maintenance data is based on LED testing per IESNA LM-80 and projected per IESNA TM-21



Benefits and Features

- NSF Certified
- Efficacy up to 135 lumens per watt
- Electrical: 50/60Hz, 120-277V
- Polycarbonate lens: safe for food processing applications
- No external reflectors required
- Operating temperature: -40°C up to 40°C
- Body and mounting loop are Aluminum alloy
- Stainless steel hardware
- IP69K Rating
- 5 years warranty
- 5000K CCT; 80 CRI
- Beam angle: 90° standard; optional 50° and 120° beam angles available
- Superior temperature stability
- Temperature tested at toughest conditions
- White fixture color option available



Photometrics

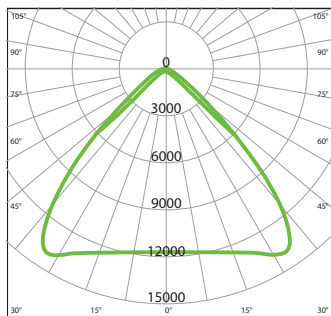

Dimensions

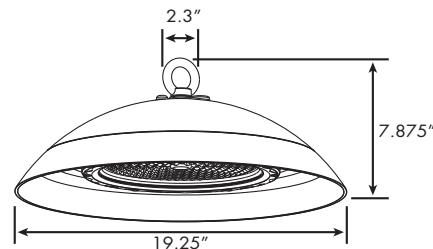

Accessories (Order as separate line items)

- LN13632 - 120° Clear plastic flat lens
- LN13492 - 120° Frosted plastic lens
- LN13421 - 120° Clear tempered glass lens
- LN28431 - 50° Clear plastic lens
- AC78126 - Pendant mount kit

Factory installed Indoor and NSF certified watertight plug options are available, see spec sheets for details



NEMA L5-15P
For 120V Input



NEMA L18-20P
For 208V Input



NEMA L6-15P
For 240V Input



NEMA L7-15P
For 277V Input



IP69K



Note: * NSF Certified for Splash Zone, not for food contact



LED HIGHBAY LIGHTING

Wave Aisle Lighter

120-277V

Wattage	Order Code	Lumen Output	Color Temp.	CRI	Lumen Maint. @50,000 hours†	Calc. L70@25°C Amb.(hrs)†	Fixture Color	Amp. Draw (A) 120V 277V	Replaces Existing HID Wattage
90W	HB42342	10350	5000K	80	90%	159,000	Matte Silver	0.76 0.33	250W

† Lumen maintenance data is based on LED testing per IESNA LM-80 and projected per IESNA TM-21



Benefits and Features

- Extruded aluminum heat sink housing with powder coated aluminum end caps and stainless steel hardware
- Precision optic, polycarbonate lens achieves 60 x 90 distribution
- Optical chamber is sealed and gasketed
- Operating temperature range of -30° C to 50° C
- 3X longer life than traditional technology, reducing maintenance costs
- 5 year warranty
- 80% Energy Savings
- Universal 120-277V 50/60 Hz input
- 0-10V DC dimming standard to maximize energy savings
- cULus rated for damp and dry locations and IP65 rated
- (2) aircraft cables included with fixture for mounting

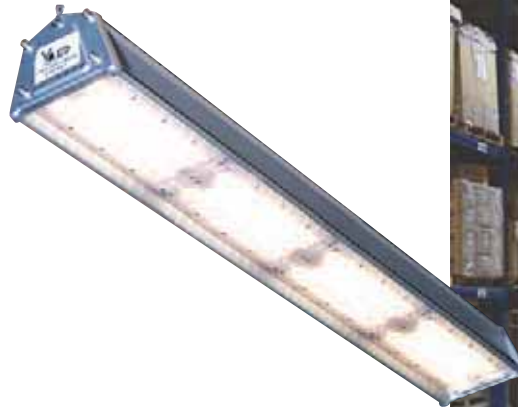

Photometrics

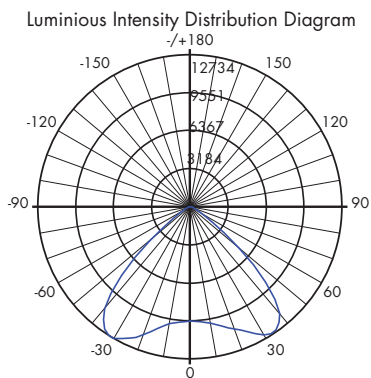

Dimensions

90W: Weight: 10.4 lbs (4.71 kg)

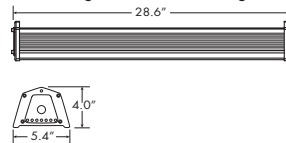

Accessories (Order as separate line items)

- KT14682** Sensor mounting kit for Wave linear highbay
- PH41623** - Dry/damp rated motion/on-off sensor only (S1) (120-277V)
- PH77409** - Dry/damp rated motion/on-off/photocell/dimming sensor (S2) (120-277V)

Note: S1 and S2 are factory installed sensors.

Factory installed plug options are available, see spec sheets for details



NEMA L5-15P



NEMA L18-20P



NEMA L6-15P



NEMA L7-15P



IP65



LED TROFFERS

Troffers

Wattage	Order Code	Lumen Output	Color Temp.	CRI	Fixture Size	Life Hours	Fixture Color	Amp. Draw (A) 120V	Amp. Draw (A) 277V	Replaces Existing Fluorescent	DLC Model Number
32W	TR16834	3720	4000K	80	2x2	50,000	White	0.29	0.13	2x2	Not Applicable

Benefits and Features

- High quality, economical alternative to fluorescent
- Powered by LED lighting technology
- Highest return on initial investment over the life time of the fixture
- Ideal for office spaces, schools, hospitals, and many other indoor locations
- New construction or replacement of existing fluorescent fixtures
- 0-10V Dimming standard
- Rated for damp and dry locations
- IC Rated



Photometrics

32W 2x2 LED Troffer

Luminous Intensity Distribution Diagram

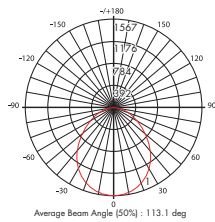

Dimensions

32W 2x2 LED Troffer

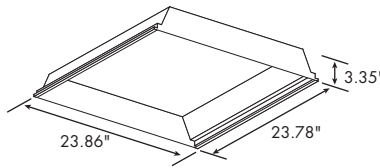

Accessories (Order as separate line items)

- KT18101 - 2x2 Drywall Mount Kit, White

Dry wall mounting kits



LED VOLUMETRIC TROFFERS

Volumetric Troffers

Wattage	Order Code	Lumen Output	Color Temp.	CRI	Fixture Size	Life Hours	Fixture Color	Amp. Draw (A) 120V	Amp. Draw (A) 277V	Replaces Existing Fluorescent	DLC Model Number
26W	TR86526	3070	3500K	80	2x2	50,000	White	0.23	0.10	2x2	-
26W	TR39826	3275	4000K	80	2x2	50,000	White	0.23	0.10	2x2	-

NOTE: For a factory installed Battery Backup add "-EM" after order code

Benefits and Features

- High quality
- Economical
- Powered by LED lighting technology
- Highest return on initial investment over the life time of the fixture
- Ideal for office spaces, schools, hospitals, and many other indoor locations
- Single diffused lens
- Smooth, low glare illuminance
- New construction or replacement of existing fluorescent fixtures
- 0-10V Dimming standard
- Rated for damp and dry locations
- IC Rated
- Factory installed battery back-up available

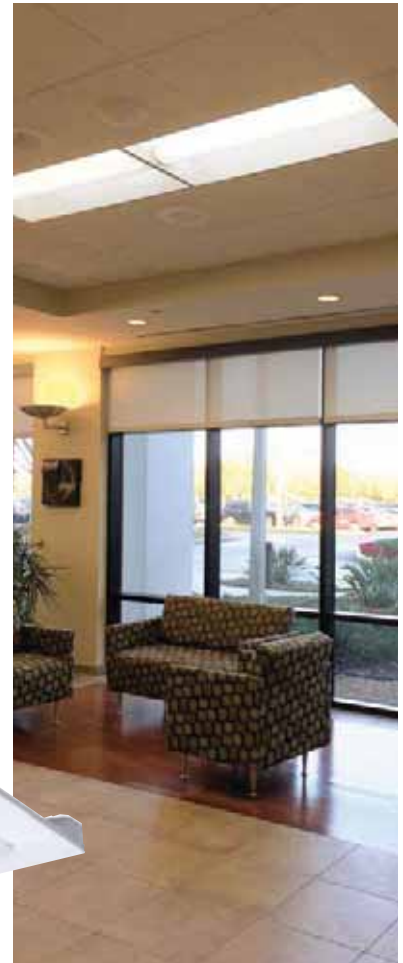

Photometrics

26W 2x2 LED Volumetric Troffer

Luminous Intensity Distribution Diagram

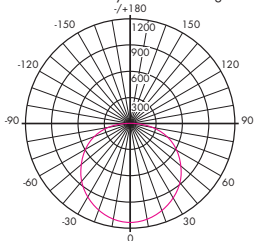

Dimensions

26W 2x2 LED Volumetric Troffer

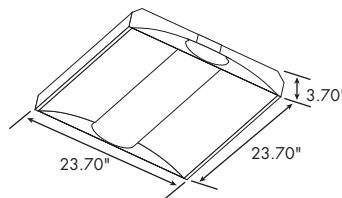

Accessories (Order as separate line items)

- LN17209** - 2x2 Replacement lens
- KT18101** - 2x2 Drywall Mount Kit, White
- AC25420** - AFC 3/8 F - 3146 14/3X6' FIX WHIP, 3-WIRE 120V

Add suffix "-WP" to order code for a factory installed fixture with a 6ft whip (Part # AC25420)

For a factory installed Battery Backup add "-EM" after order code



LED SELECT-PRO PANELS



Venture's Select-Pro LED panels
Available in 2x4, 2x2, and 1x4

LED Select-Pro Panels

Venture Lighting's Select-Pro edge-lit LED panels are low profile, lightweight, and designed for long life and low maintenance. These thin luminaires are designed to quickly and easily upgrade existing fluorescent fixtures and be more versatile than other LED panels. The high performance LED source is mounted to ensure proper thermal management of the system. Each fixture is capable of changing to 3 different CCT settings (3500K, 4000K, 5000K) and 3 different wattage settings (3 light levels) with a simple slide switch. The flexible selection capability allows for a cost effective method to reduce stocking inventory by 88% (1 SKU instead of 9). All Select-Pro Panel fixtures are preset to the highest wattage and 4000K CCT.

Benefits and Features

- Change from 3500K, 4000K or 5000K with just the flip of a switch
- Choose from three different wattages with just the flip of a switch
- Reduce inventory SKUs by 88%
- Easy to install
- Battery back-up option available
- Edge-lit, low glare and easy on the eyes
- Designed for upgrading existing fluorescent fixtures or for new construction
- 0-10V DC dimming standard to maximize energy savings
- Rated for damp and dry locations
- IC Rated
- Universal 120-277V 50/60 Hz input



CCT/Wattage Field Adjustable Switches



3500K



4000K



5000K



WATTAGE AND CCT SELECTABLE LED PANELS

Select-Pro Edge-Lit Panels

Panel Size	Model Number	3500K			4000K		5000K		CRI	Life Hours	Weight
		Wattage	Lumen Output	LPW	Lumen Output	LPW	Lumen Output	LPW			
2x4	P424-45-UNV-C&W	45	5194	115	5583	124	5510	122	80	50000	11.6
		35	4097	117	4404	125	4347	124			
		30	3565	118	3832	128	3782	126			
2X2	P422-40-UNV-C&W	40	4660	117	5101	128	4792	120	80	50000	5.75
		30	3746	125	4101	137	3852	128			
		25	3370	135	3689	148	3465	139			
1x4	P414-40-UNV-C&W	40	4326	108	4671	117	4378	110	80	50000	6.42
		30	3478	116	3755	126	3520	117			
		25	3042	122	3285	131	3079	123			



Switches located on back of panel



Benefits and Features

- Edge-lit optics, low glare and easy on the eyes
- 3 different CCT settings: 3500K, 4000K, 5000K
- 3 wattage settings; 3 different light levels
- Simple slide switch, no cumbersome dip switches
- Reduce stocking inventory by 88%: 1 SKU instead of 9
- Input Volts: 120-277V, 50/60 Hz

Dimensions

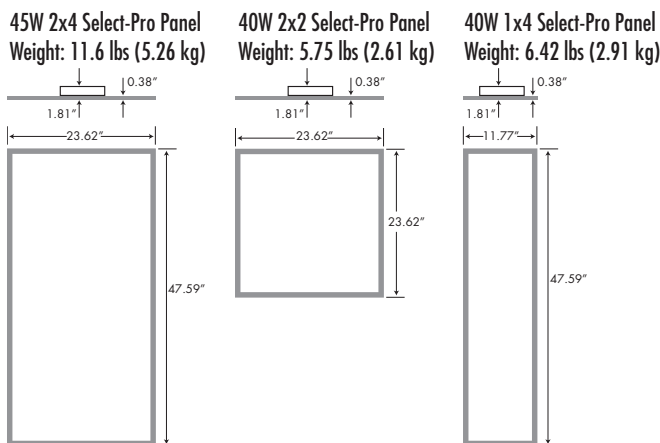

Accessories (Order as separate line items)

- BB26329** - 7.8W Battery back-up
- KT14136** - 1x4 Drywall Mount Kit, White
- KT20945** - 1x4 Surface Mount Kit, White
- KT18101** - 2x2 Drywall Mount Kit, White
- KT14156** - 2x2 Surface Mount Kit, White
- KT18916** - 2x4 Drywall Mount Kit, White
- KT18522** - 2x4 Surface Mount Kit, White
- AC25420** - 3/8" 3-wire 14/3 600V Max. 6FT Flex Whip

Add suffix "-WP" to order code for a factory installed fixture with a 6ft whip (Part # AC25420)

For a factory installed Battery Backup add "-EM" after order code
For a factory installed Lutron PowPack add "-PP" after order code



WATTAGE AND CCT SELECTABLE LED PANELS

Select-Pro Back-Lit Panels

Panel Size	Model Number	3500K			4000K		5000K		CRI	Life Hours	Weight (lbs)
		Wattage	Lumen Output	LPW	Lumen Output	LPW	Lumen Output	LPW			
2x4	PB124-45-UNV-C&W	45	5150	114	5350	119	5250	117	≥80	50000	9.45
		35	4000	114	4150	119	4050	116			
		30	3400	113	3550	118	3500	117			
2X2	PB122-35-UNV-C&W	35	3950	113	4200	120	4050	116	≥80	50000	5.35
		30	3400	113	3600	120	3450	115			
		20	2250	113	2400	120	2300	115			
1x4	PB114-35-UNV-C&W	35	3900	111	4150	119	4000	114	≥80	50000	4.75
		30	3300	110	3550	118	3400	113			
		20	2200	110	2350	118	2250	113			



Benefits and Features

- Back-lit optics, low glare and easy on the eyes
- 3 different CCT settings: 3500K, 4000K, 5000K
- 3 wattage settings; 3 different light levels
- Simple slide switch, no cumbersome dip switches
- Reduce stocking inventory by 88%: 1 SKU instead of 9
- Input Volts: 120-277V, 50/60 Hz

Dimensions

45W 2x4 Select-Pro Panel Weight: 9.45 lbs (4.28 kg)
 35W 2x2 Select-Pro Panel Weight: 5.35 lbs (2.42 kg)
 35W 1x4 Select-Pro Panel Weight: 4.75 lbs (2.15 kg)

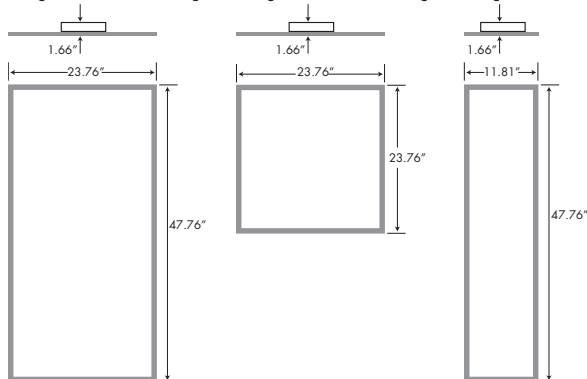

Accessories (Order as separate line items)

- KT23281** - Battery back-up Kit for 1x4
- KT23279** - Battery back-up Kit for 2x2 and 2x4
- KT14136** - 1x4 Drywall Mount Kit, White
- KT48110** - 1x4 Surface Mount Kit, White
- KT18101** - 2x2 Drywall Mount Kit, White
- KT48112** - 2x2 Surface Mount Kit, White
- KT18916** - 2x4 Drywall Mount Kit, White
- KT48114** - 2x4 Surface Mount Kit, White
- AC25420** - 3/8" 3-wire 14/3 600V Max. 6FT Flex Whip

Add suffix "-WP" to order code for a factory installed fixture with a 6ft whip (Part # AC25420)

For a factory installed Battery Backup add "-EM" after order code



LED PANELS

LED Panels

120-277V

Panel Size	Wattage	Order Code	Lumen Output	Color Temp.	CRI	Life Hours	Fixture Color	DLC Qualified	Replaces Existing HID Wattage	DLC Model Number
1x4	36W	PN17467	3900	3500K	80	50,000	White	-	64W	-
2x2	40W	PN28633	4030	4000K	80	50,000	White	-	64W	-

LED Panels

208-347V

Panel Size	Wattage	Order Code	Lumen Output	Color Temp.	CRI	Life Hours	Fixture Color	DLC Qualified	Replaces Existing HID Wattage	DLC Model Number
2x4	48W	PN41312	5170	3500K	80	50,000	White	-	96W - 128W	-



Benefits and Features

- Glass-free construction with internal driver
- Edge-lit optics, low glare and easy on the eyes
- Thin profile and easy to handle
- For retrofit or new construction with T-Bar applications
- 50,000 hour life; 65% Longer Life
- 5 year warranty

Photometrics

40W 2x2 LED Panel

Luminous Intensity Distribution Diagram

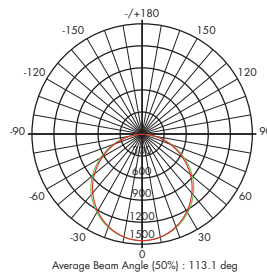

Dimensions

48W 2x4 LED Panel

Weight: 20.2 lbs (9.16 kg)

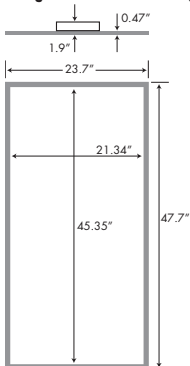

40W 2x2 LED Panel

Weight: 10.6 lbs (4.80 kg)

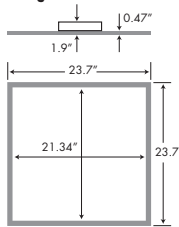

36W 1x4 LED Panel

Weight: 10.6 lbs (4.80 kg)

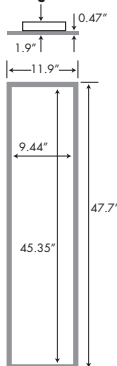

Accessories (Order as separate line items)

- BB23468** - Battery back-up
- KT14136** - 1x4 Drywall Mount Kit, White
- KT20945** - 1x4 Surface Mount Kit, White
- KT18101** - 2x2 Drywall Mount Kit, White
- KT14156** - 2x2 Surface Mount Kit, White
- KT18916** - 2x4 Drywall Mount Kit, White
- KT18522** - 2x4 Surface Mount Kit, White



LED LINEAR LIGHTING

Vapor Tight

120-277V

Wattage	Order Code	Lumen Output	Color Temp.	CRI	Fixture Length	Lumen Maint. @50,000 hours†	Calc. L70@25°C Amb.(hrs)†	Fixture Color	DLC Qualified	Replaces Existing Wattages	DLC Model Number
55W	VP61784	7200	4000K	80	4'	86%	108,000	Gray	-	(2) 32W	-

NOTE: For a factory installed Battery Backup add "-EM" after order code

† Lumen maintenance data is based on LED testing per IESNA LM-80 and projected per IESNA TM-21

Benefits and Features

- UL listed for wet locations
- Light weight design allows for easy installation
- Input voltages available: 120-277
- 0-10V Dimming standard
- Surface mount kit and V-Hooks for dual point chain suspension included
- Factory installed battery back-up available
- Stainless steel clips
- Polycarbonate lens
- NEMA Type 4X enclosure rating



Photometrics

55W Vapor tight

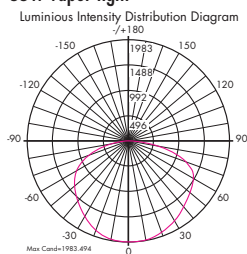

Dimensions

55W Vapor tight

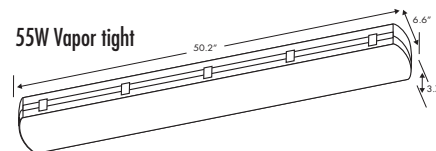

Accessories (Order as separate line items)

- SP12714 - 120-277V Surge Protector
- PH58143 - Wet Rated Motion Only Control Sensor
- PH52171 - Wet Rated Motion/Photocell/Dimming Control Sensor

Surface mount clips and V-Hook for dual point chain or cable hanging included

For a factory installed Battery Backup add "-EM" after order code



IP65



NEMA 4X



LED RECESSED DOWNLIGHTS

Downlight Retrofit Kits

Wattage	Dia.	Order Code	Lumen Output	Color Temperature	CRI	Rated Life (hrs)	Beam Angle	Amp. Draw (A)		Replaces Existing CFL	Replaces Existing MH	(Energy Star) Model Number	Trim
								120V	277V				
18W	6"	DL38134	1318	4000K	80+	35,000	90°	0.15	0.07	32W	70W	DLB-1801N-WH	White
18W	6"	DL38412	1318	5000K	80+	54,000	90°	0.15	0.07	32W	70W	DLB-1801C-WH	White
18W	6"	DL38145	1318	4000K	80+	54,000	90°	0.15	0.07	32W	70W	DLB-1801N-SV	Silver
40W	8"	DL42017	3163	3000K	80+	54,000	90°	0.35	0.16	2x32W	100W	DLC-4001W-WH	White
40W	8"	DL42531	3163	5000K	80+	54,000	90°	0.35	0.16	2x32W	100W	DLC-4001C-WH	White
54W	8"	DL20658	4100	4000K	80+	35,000	90°	0.48	0.22	2x42W	175W	Not Applicable	White



Benefits and Features

- Energy saving of up to 75%, compared to Compact Fluorescent and Metal Halide
- Upgrade standard CFL and HID 6" or 8" diameter recessed luminaires to high output LED (with 80+ CRI)
- 3X longer life than traditional technology, reducing maintenance costs
- Energy Star Certified (specific models only)
- cULus rated for dry and damp locations
- Light weight design allows for easy installation
- Universal 120-277V 50/60 Hz input
- 0-10V DC dimming standard to maximize energy savings
- White and Silver trim

Photometrics

Luminous Intensity Distribution Diagram

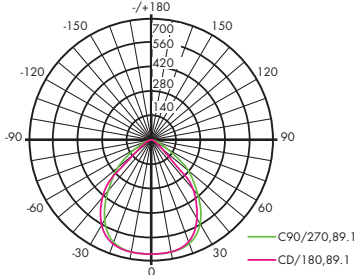

Dimensions

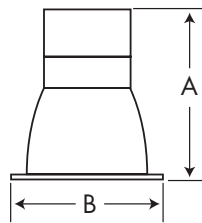

Diam.	A (in)	B (in)	Weight
6"	5.68	7.48	1.9 lbs (0.84 kg)
8"	6.38	9.29	2.3 lbs (1.04 kg)

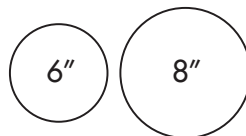

Accessories (Order as separate line items)

- BB24622** - Battery Back-up
- KT86415** - New construction kits for 6" downlight
- KT65235** - New construction kits for 8" downlight



LED LINEAR LIGHTING

40W Wrap

Wattage	Order Code	Lumen Output	Color Temp.	CRI	Fixture Length	Lumen Maint. @50,000 hours†	Calc.L70@25°C Amb.(hrs)†	Fixture Color	Replaces Existing HID Wattage	DLC Qualified	DLC Model Number
40W	SM29193	4640	4000K	80	4'	90%	161,000	White	(2) 32W	Standard	SM2-40N8D4-04

NOTE: † Lumen maintenance data is based on LED testing per IESNA LM-80 and projected per IESNA TM-21



Benefits and Features

- Universal 120-277V 50/60 Hz input
- 0-10V Dimming standard
- ULus rated; Damp listed

Photometrics

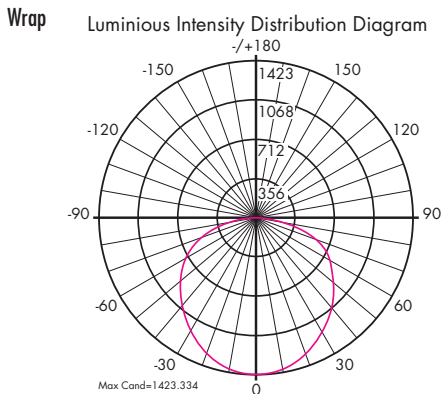

Dimensions

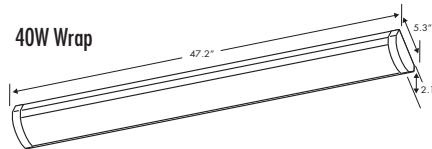

Accessories (Order as separate line items)

- AC25420 - 3/8" 3-wire 14/3 600V Max. 6FT Flex Whip

Add suffix "-WP" to order code for a factory installed fixture with a 6ft whip (Part # AC25420)



LED LINEAR STRIP LIGHTS

Select-Pro Linear Strip

120-277V

Model Number	3500K			4000K			5000K			CRI	Fixture Length	Life Hours	Weight	DLC Qualified	DLC Model Number
	Wattage	Lumen Output	LPW	Lumen Output	LPW	Lumen Output	LPW								
SM10928	45	5895	131	5940	132	5985	133	80	4'	50000	4.5	Standard		SM5-4H-45/38/34-D835/40/50	
	38	5206	137	5244	138	5282	139								
	34	4760	140	4794	141	4828	142								
SM12847	90	11790	131	11880	132	11970	133	80	8'	50000	9.0	Standard		SM5-8H-90/75/65-D835/40/50	
	75	10275	137	10350	138	10425	139								
	65	9100	140	9165	141	9230	142								

Linear Strip

120-277V

Wattage	Order Code	Lumen Output	Color Temp.	CRI	Fixture Length	Life Hours	Fixture Color	DLC Qualified	Replaces Existing Fixture	DLC Model Number
45W	SM55014	5800	3500K	80	4'	50,000	White	-	2 x 32W T8 Fluorescent	-
54W	SM15401	7200	3500K	80	8'	50,000	White	-	80W T12 Fluorescent	-
54W	SM51723	7200	4000K	80	8'	50,000	White	-	80W T12 Fluorescent	-



Surface mount brackets, included



Photometrics

34-45W Select-Pro Linear Strip Light

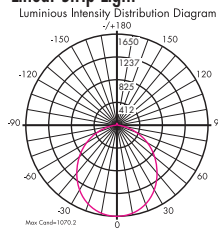

65-90W Select-Pro Linear Strip Light

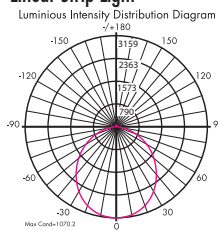

45W Linear Strip Light

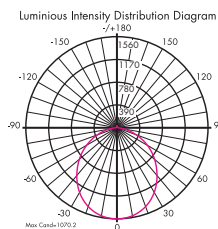

54W Linear Strip Light

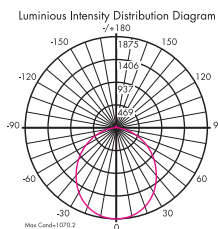

Dimensions

4ft Linear Strip Light

Weights
45W 4ft - 4.8 lbs (2.2 kg)

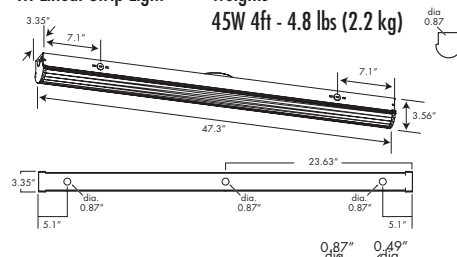

8ft Linear Strip Light

Weights
54W 8ft - 9.1 lbs (4.1 kg)

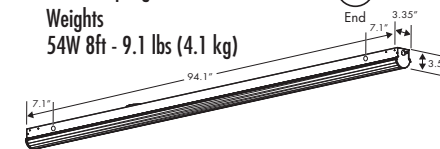

8ft Select-Pro Linear Strip Light

Weights
90W 8ft - 9.0 lbs (4.1 kg)

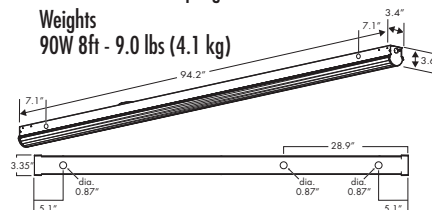

Accessories

- PH41623 - Dry/damp rated motion/on-off sensor only (S1) (120-277V)
- PH77409 - Dry/damp rated motion/photocell/dimming sensor (S2) 120-277V
- AC25420 - 3/8" 3-wire 14/3 600V Max. 6ft Flex Whip
- AC13812 - Surface mount clips and hooks
- AC20156 - V-hooks with 6ft cables (for suspension mount)
- AC35187 - Row alignment accessory
- LN18733 - Replacement 4ft lens, acrylic
- LN18734 - Replacement 8ft lens, acrylic
- KT12139 - 4ft wire guard kit, (2) required for 8ft fixtures

Factory installed accessories:

- Add suffix "-S1" to order code for a factory installed fixture with a MOTION ONLY Sensor part # PH41623
- Add suffix "-S2" to order code for a factory installed fixture with a MOTION/DIM/PHOTOCELL Sensor part # PH77409
- Add suffix "-S5" to order code for a factory installed fixture with a Bluetooth PIR Sensor
- Add suffix "-EM" to order code for a factory installed 10W battery back-up
- Add suffix "-WP1" for 6ft 3-wire whip factory installed on the end of the strip.
- Add suffix "-WP2" for 6ft 3-wire whip factory installed on the back of the strip.



LED TEMPORARY WORK LIGHT

Temporary Lighting

Wattage	Order Code	Lumen Output	Color Temp.	CRI	Life Hours	Fixture Color	Amp. Draw (A) 120V	Mounting
100W	SM20896	12500	5000K	80	50,000	Orange	0.85	hook (carabiner style)

Benefits and Features

- Linkable by built in receptacle
- Energy saving of up to 75%, compared to Compact Fluorescent and Metal Halide
- Perfect for construction sites, warehouses, factories, exhibition halls, workshops and more
- 3X longer life than traditional technology, reducing maintenance costs
- UL listed
- IP64 Rated
- Light weight design allows for easy installation
- The power supply accepts 120V 60 Hz input
- Each fixture supplied with SJTOW 9 foot cord with NEMA 5-15 straight blade plug
- Supplied with hook with spring clip
- Operating temperature of -20°C to 40°C
- Protective wire-guard
- Glass-free construction
- Each fixture is linkable via the integrated receptacle
- Link up to 11 fixtures



Linkable by built in receptacle



NEMA 5-15 straight blade plug



Photometrics

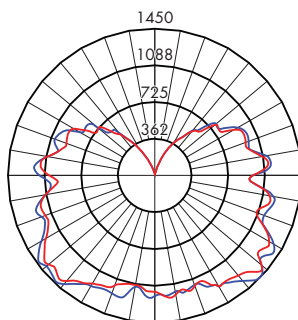

— C0-C180 — C90-C270

Dimensions

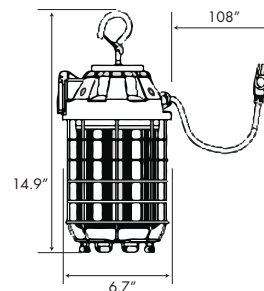

EXTERIOR LIGHTING SOLUTIONS



*Environ LED Area Lighting with
Synapse® Twist Lock Controller*



LED TRADITIONAL STYLE WALLPACKS

Venture Lighting's color temperature selectable and wattage selectable luminaire is capable of changing to 3 different CCT settings and 5 different wattage settings. These field-adjustable fixtures are preset to the highest wattage (can be adjusted via an internal rotary switch) and 5000K CCT (can be adjusted via an internal slide switch). The flexible selection capability allows for a cost-effective method to reduce stocking inventory to 1 SKU instead of 15. This LED luminaire is designed for great performance, long life, and low maintenance.

Select-Pro Wallpacks

Model Number	3000K		4000K		5000K		CRI	Calc.L70@25°C Amb.(hrs) [†]	Weight	DLC Qualified	DLC Model Number	
	Wattage	Lumen Output	LPW	Lumen Output	LPW	Lumen Output						LPW
WP16318	80	12032	150	12770	160	12245	153	80	174,000	7.7	Premium	WH5MUNV-80BSGD-BRW50
	65	9596	148	10185	157	9766	150					
	50	7382	148	7834	157	7512	150					
	35	5167	148	5484	157	5259	150					
	20	2953	148	3134	157	3005	150					
WP53512	150	21514	143	23223	155	21438	143	80	174,000	11.5	Premium	WH5LUNV-150BSGD-BRW50
	130	17940	138	19370	149	17810	137					
	110	15180	138	16390	149	15070	137					
	90	12420	138	13410	149	12330	137					
	70	9660	138	10430	149	9590	137					



Photometrics

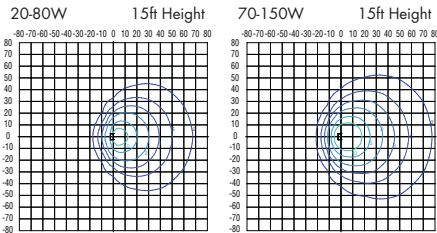

Dimensions

20-80W
Weight: 7.7 lbs (3.49 kg)

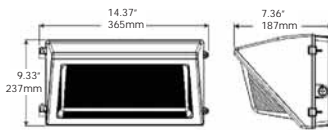

70-150W
Weight: 11.5 lbs (5.22 kg)

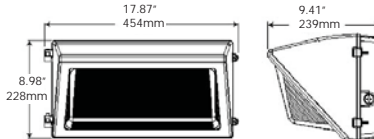

Wattage Selectable Switch



CCT Selectable Switch

Accessories (Order as separate line items)

- SP12714 - Surge protector (120-277V)



Standard Wallpacks

Wattage	Order Code	Lumen Output	Color Temp.	CRI	Lumen Maint. @50,000 hours [†]	Calc.L70@25°C Amb.(hrs) [†]	Fixture Color	DLC Qualified	Replaces Existing HID Wattages	DLC Model Number
80W	WP31268	9660	4000K	80	81%	89,000	Bronze	-	250W	-

NOTE: [†] Lumen maintenance data is based on LED testing per IESNA LM-80 and projected per IESNA TM-21

Photometrics

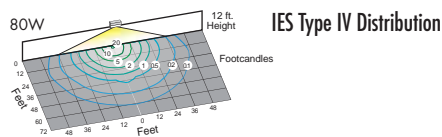

Dimensions

80W
Weight: 10 lbs (4.54 kg)

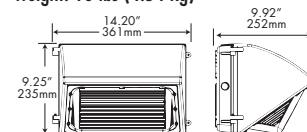

Accessories (Order as separate line items)

- SP12714 - Surge protector (120-277V)
 - PH56903 - Button Photocell (120-277V)
- For a factory installed button photocell add suffix "-P"
For a factory installed Battery Backup add "-EM" after order code



SP12714



PH56903



LED WALLPACKS

VWallpax

Wattage	Order Code	Lumen Output	Color Temp.	CRI	Lumen Maint. @50,000 hours [†]	Calc. L70@25°C Amb.(hrs) [†]	Fixture Color	DLC Qualified	Replaces Existing HID Wattage	DLC Model Number
80W	WP59416	8710	4000K	75	99%	>500,000	Bronze	-	250W	-

NOTE: † Lumen maintenance data is based on LED testing per IESNA LM-80 and projected per IESNA TM-21

Benefits and Features

- Optical chamber is sealed and gasketed
- Operating temperature range of -40° C to 40° C
- 3X longer life than traditional technology, reducing maintenance costs
- 5 year warranty
- 80% Energy Savings
- Universal 120-277V 50/60 Hz input
- Rated for wet locations

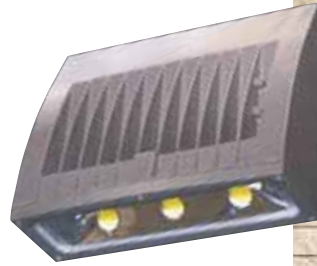

Photometrics

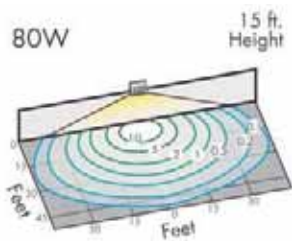

Dimensions

80W Weight:
11.3 lbs (5.13 kg)

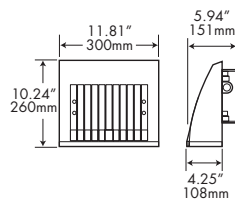

Accessories (Order as separate line items)

- PH56903 Button Photocell (120-277V)



PH56903



WATTAGE AND CCT SELECTABLE LED FLOODS

Select-Pro Floods

Order Code	3000K			4000K			5000K			CRI	Calc.L70@25°C Amb.(hrs) [†]	DLC Qualified	DLC Model Number	Weight
	Wattage	Lumen Output	LPW	Lumen Output	LPW	Lumen Output	LPW							
FL58601	50	6312	126	7148	143	6576	132	80+	131,000	Premium	FLUNV-50WCH8DA1- BRPFM50W	4.4 lbs		
	45	5797	129	6564	146	6039	134							
	40	5153	129	5835	146	5368	134							
	35	4380	125	5153	147	4563	130							
FL70326	90	11320	126	12328	137	11920	132	80+	131,000	Premium	FLUNV-90WCH8A2- BRPFM50W	6.8 lbs		
	80	10188	127	11095	139	10728	134							
	70	9056	129	9862	141	9536	136							
	65	7924	122	8629	133	8344	128							

NOTE: † Lumen maintenance data is based on LED testing per IESNA LM-80 and projected per IESNA TM-21



Benefits and Features

- 3 different CCT settings: 3000K, 4000K, 5000K
- 4 wattage settings; 4 different light levels
- Reduce stocking inventory by 92%: 1 SKU instead of 12
- Supplied with U-Bracket
- Photocell included - No external photocell required
- Long life and low maintenance
- Input Volts: 120-277V, 50/60 Hz
- DesignLights Consortium® (DLC) Premium Qualified



CCT and Wattage Selectable Switches



Dimensions

35W-50W
Weight: 4.4 lbs (2.0 kg)

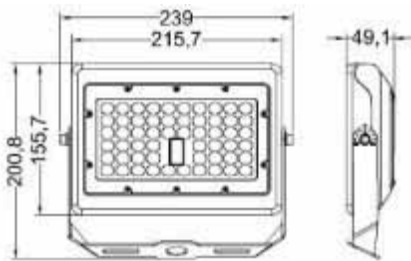

65W-90W
Weight: 6.8 lbs (3.1 kg)

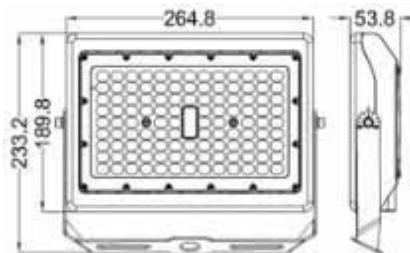

Accessories (Order as separate line items)

Accessories for FL58601 (35W-50W)

- AC14440 - Adjustable knuckle mount
- AC14435 - Adjustable slipfitter mount

Accessories for FL70326 (65W-90W)

- AC14450 - Adjustable knuckle mount
- AC14445 - Adjustable slipfitter mount
- SP12714 - 120-277V Surge protector



LED FLOODS AND AREA LIGHTING

VFlood

120-277V

Wattage	Order Code	Lumen Output	Color Temp.	CRI	Lumen Maint. @50,000 hours†	Calc. L70@25°C Amb.(hrs)†	Fixture EPA	Fixture Color	DLC Qualified	Replaces Existing HID Wattage	DLC Model Number
110W	FL63170	15414	5000K	≥70	89%	145,000	0.32	Bronze	Premium	Up to 400W	FA-110-CA
121W	FL14587	13950	4000K	80	93%	268,000	0.32	Bronze	-	400W	-
212W	FL21258	23640	4000K	80	93%	258,000	0.51	Bronze	-	1000W	-
212W	FL00502	25343	5000K	80	93%	258,000	0.51	Bronze	-	1000W	-

NOTE: † Lumen maintenance data is based on LED testing per IESNA LM-80 and projected per IESNA TM-21 Available in 3000K and 3500K. Check for lead time.

VFlood

277-480V

Wattage	Order Code	Lumen Output	Color Temp.	CRI	Lumen Maint. @50,000 hours†	Calc. L70@25°C Amb.(hrs)†	Fixture EPA	Fixture Color	DLC Qualified	Replaces Existing HID Wattage	DLC Model Number
110W	FL52037	15924	5000K	≥70	89%	145,000	0.32	Bronze	Premium	Up to 400W	FA-110-CB
121W	FL15312	13700	4000K	80	93%	268,000	0.32	Bronze	-	400W	-

NOTE: † Lumen maintenance data is based on LED testing per IESNA LM-80 and projected per IESNA TM-21

Benefits and Features

- Rugged die cast housing with a durable powder coat finish
- Tempered glass lens
- Twist lock photocell receptacle and shorting cap included with the fixture.
- Operating temperature range of -40° C to 40° C
- 10KA surge protection
- DesignLights Consortium® (DLC) qualified
- 0-10V DC dimming standard



Photometrics

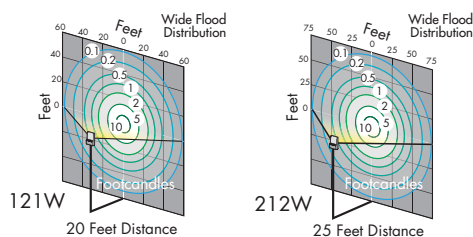

Wattages	B-U-G Rating
110W/121W	B3-U2-G1
212W	B4-U2-G2

Dimensions

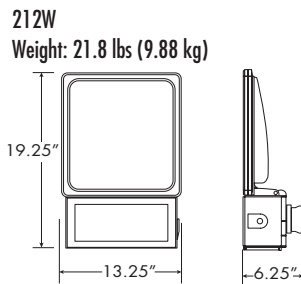
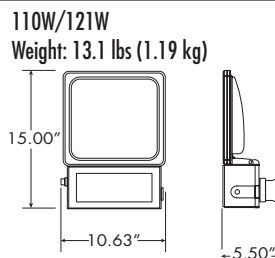

Accessories (Order as separate line items)

Mounting Accessories for 110W/121W

- FL64171 U-Bracket, bronze
- FL22402 6" Square pole straight arm, bronze
- FL26815 6" Round pole straight arm (4" min.), bronze
- FL25107 Adjustable slipfitter (2-3/8" tenon), bronze

Mounting Accessories for 212W

- FL99436 U-Bracket, bronze
- FL22402 6" Square pole straight arm, bronze
- FL26815 6" Round pole straight arm (4" min.), bronze
- FL25107 Adjustable slipfitter (2-3/8" tenon), bronze

Common Accessories for All VFlood Fixtures

- PH12415 3-Pin Twist lock photocell (120-277V)
- PH81156 3-Pin Twist lock photocell (480V)
- PH87145 3-Pin Twist lock photocell (347V)
- PH81975 Replacement shorting cap
- SP12714 120-277V surge protector
- SP12826 347-480V surge protector



LED Floods

Roundback VFloods

Wattage	Order Code	Lumen Output	Color Temp.	CRI	Lumen Maint. @50,000 hours †	Calc.L70@25°C Amb.(hrs) †	Fixture Color	Replaces Existing HID Wattage	DLC Qualified	DLC Model Number
20W	FL59317	2250	4000K	75+	90%	163,000	Bronze	70-100W	-	-
80W	FL68933	9300	4000K	75+	90%	>500,000	Bronze	250W	-	-

NOTE: † Lumen maintenance data is based on LED testing per IESNA LM-80 and projected per IESNA TM-21

Benefits and Features

- Rugged die cast housing with a durable powder coat finish
- Twist lock photocell receptacle and shorting cap included with the fixture (80W fixture only)
- Optical chamber is sealed and gasketed
- Operating temperature range of -40° C to 40° C
- 10KA surge protection
- 5 year warranty
- 80% Energy Savings
- Rated for wet locations



Photometrics

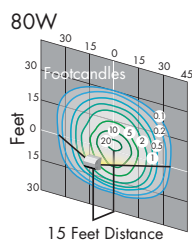
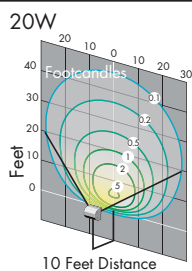

Dimensions

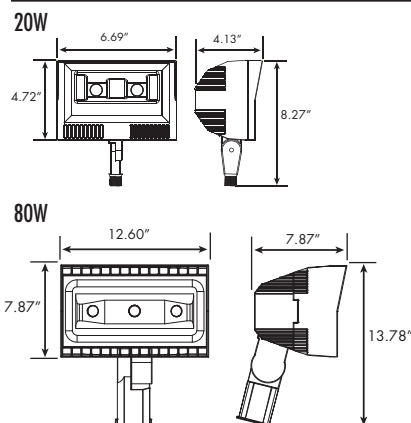

Accessories (Order as separate line items)

- KT56256** U-bracket accessories kit for 20W roundback flood, bronze
- KT56338** U-bracket accessories kit for 80W roundback flood bronze
- PH12415** Twist lock photocell (120-277V)



Parts shown are provided as part of
KT56256 and KT56338



AREA LIGHTING

Environ

Venture Lighting's Environ area light fixtures combine a sleek, reliable design with precise ANSI optical distributions to make the ideal upgrade for area/site, roadway, and automotive applications. Perfect for new construction or easy replacement of existing installations.

Benefits and Features

- Rugged die cast housing with a durable powder coat finish
- Vandal resistant polycarbonate lens
- Optical chamber is sealed and gasketed
- Factory installed motion sensor available
- Each fixture will be supplied with a 7-pin receptacle and a shorting cap
- Operating temperature range of -40° C to 40° C
- 10kA surge protection
- 5 year warranty
- 80% Energy Savings
- UL Rated for wet locations
- Universal 120-277V 50/60 Hz input or 347-480V input
- 0-10V DC dimming standard to maximize energy savings



3000K color temperature and fixed mounting must be selected for IDA approval



LED AREA LIGHTING

Low Watt Environ

Ordering & Model Number Information

Choose nomenclature that suits application. Example: **ENV-150CT2-ABZ-SHM12**

ENV-	150	C	T2-	A	BZ-	SH	M12
Fixture Type	Wattage	Color Temp.	Optics	Voltage	Fixture Finish	Shield	Options

- | | | | | | | | |
|---|-------------------------------------|------------------------------------|--|---------------------------------------|--------------------------------------|--|---|
| ENV - Venture's LED Area Fixture | <input type="checkbox"/> 150 - 150W | <input type="checkbox"/> W - 3000K | <input type="checkbox"/> T2 - Type II | <input type="checkbox"/> A - 120-277V | <input type="checkbox"/> BZ - Bronze | "Blank" - No backlight shield | "Blank" - No motion sensor |
| | <input type="checkbox"/> 200 - 200W | <input type="checkbox"/> B - 3500K | <input type="checkbox"/> T3 - Type III | <input type="checkbox"/> B - 347-480V | | <input type="checkbox"/> SH - Backlight shield † | <input type="checkbox"/> M12 - 120-277V Motion/Dim/Photocell sensor |
| | | <input type="checkbox"/> N - 4000K | <input type="checkbox"/> T4 - Type IV | | | | <input type="checkbox"/> M34 - 347-480V Motion/Dim/Photocell sensor |
| | | <input type="checkbox"/> C - 5000K | <input type="checkbox"/> T5 - Type V | | | | |

Notes: † = For Type II, III and IV only



Performance Data

Wattage	Lumen Output	Color Temp.	CRI	Lumen Maint. @50,000 hours †	Calc. L70@25°C Amb.(hrs) †	Fixture EPA	Color	DLC Qualified	Replaces Existing HID Wattages
150W	16800	3000K	70	99%	>500,000	0.70	Bronze	-	250W V, 400W H
150W	17400	3500K	70	99%	>500,000	0.70	Bronze	-	250W V, 400W H
150W	17960	4000K	70	99%	>500,000	0.70	Bronze	-	250W V, 400W H
150W	18240	5000K	70	99%	>500,000	0.70	Bronze	-	250W V, 400W H
200W	23560	3000K	70	99%	>500,000	0.78	Bronze	-	400W V, 1000W H
200W	24480	3500K	70	99%	>500,000	0.78	Bronze	-	400W V, 1000W H
200W	25400	4000K	70	99%	>500,000	0.78	Bronze	-	400W V, 1000W H
200W	25690	5000K	70	99%	>500,000	0.78	Bronze	-	400W V, 1000W H

NOTE: Lumens listed are for Type V distribution

Mounting accessories are ordered separately

† Lumen maintenance data is based on LED testing per IESNA LM-80 and projected per IESNA TM-21

Photometrics

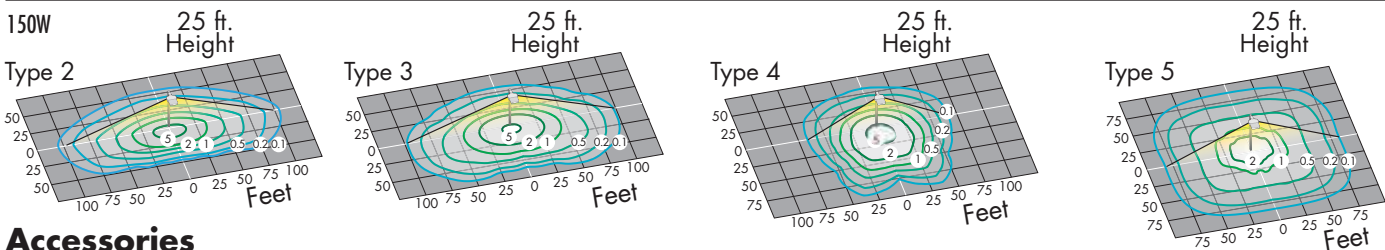

Accessories

Mounting Accessories

- EN14178 - Round pole straight arm - bronze
- EN26814 - Square pole mount - bronze
- EN35512 - Adjustable slipfitter - bronze
- EN38419 - Mast arm (Horizontal tenon) - bronze
- EN47832 - Wall mount - bronze

Photocell Accessories

- PH12415 - 3-Pin Twist lock photocell (120-277V)
- PH81156 - 3-Pin Twist lock photocell (480V)
- PH87145 - 3-Pin Twist lock photocell (347V)
- PH81975 - Replacement shorting cap

Wireless Controls Accessories

- WCN-7P-UNV - Synapse® Twist lock controller
- WCG-450 - Synapse® Gateway

Miscellaneous Accessories

- SP12714 - 120-277V surge protector
- SP12826 - 347-480V surge protector
- PH46224 - Wireless program tool for M12 & M34 options

Factory Installed Options

- "-SH" - Backlight Shield (EN67410)
- "-M12" - Wireless BLE Sensor 120-277V (PH43982) + Sensor Lens (PH47512)
- "-M34" - Wireless Sensor 347-480V (PH52149) + Sensor Lens (PH47512)



3000K color temperature and fixed mounting must be selected for IDA approval



LED AREA LIGHTING

The High Watt Environ fixtures are the ideal fixture for area lighting projects where high performance and precise light distribution is required. The High Watt Environ has been upgraded to 140 lumens per watt (LPW) to increase the delivered light without increasing the required wattage. The higher LPW rating allows for higher light levels without a higher utility bill. This also maximizes the rebate potential with many utilities. In addition to the higher LPW, the Environ fixture light distributions have been redesigned to reduce backlight while providing more light to where it is needed. A Front Row Automotive distribution has been developed specifically to highlight curbside inventory in automotive applications. This distribution, coupled with the other available distributions, provides a complete automotive package.



High Lumen Environ Ordering & Model Number Information

Choose nomenclature that suits application. Example: **ENV2-300A-7CT4-BZP7SH**

ENV2 - 300		A - 7		C		T4 - BZ		P7		SH	
Series	Wattage	Voltage	CRI	CCT	Distribution	Finish	Receptacle	Accessory 1	Accessory 2		
ENV2 - Venture's LED Area Fixture	<input type="checkbox"/> 300 - 300W <input type="checkbox"/> 480 - 480W	<input type="checkbox"/> A - 120-277V <input type="checkbox"/> B - 347-480V	<input type="checkbox"/> 7 - 70 <input type="checkbox"/> N - 4000K <input type="checkbox"/> W - 3000K	<input type="checkbox"/> C - 5000K <input type="checkbox"/> N - 4000K <input type="checkbox"/> W - 3000K	<input type="checkbox"/> T3 - Type 3 <input type="checkbox"/> T4 - Type 4 <input type="checkbox"/> T5 - Type 5 <input type="checkbox"/> TT - Type Tennis <input type="checkbox"/> FA - Automotive Front Row	<input type="checkbox"/> BZ - Bronze <input type="checkbox"/> BK - Black <input type="checkbox"/> GR - Gray <input type="checkbox"/> WH - White	<input type="checkbox"/> P7 - 7-Pin (Standard) <input type="checkbox"/> M1 - 120-277V Motion Sensor <input type="checkbox"/> M3 - 347-480V Motion Sensor	<input type="checkbox"/> Blank - None <input type="checkbox"/> M1 - 120-277V Motion Sensor <input type="checkbox"/> M3 - 347-480V Motion Sensor	<input type="checkbox"/> Blank - None <input type="checkbox"/> SH - Backlight Shield		

Notes: 1 = Limited Stacked Quantities
2 = Available on T3, T4, TT, FA Distributions
3 = Motion/Dim/Photocell Sensor

Performance Data

Wattage	Distribution Type	BUG	3000K Lumens	4000K Lumens	5000K Lumens	Lumen Maint. CRI @50,000 hours†	Calc. L70@25°C Amb.(hrs)†	DLC Qualified	Replaces Existing HID Wattages	
300W	Type 3	B3-U3-G5	38,032	39,838	42,896					
	Type 4	B3-U3-G5	38,332	40,153	43,235					
	Type 5	B5-U3-G4	40,192	42,101	45,333	70	88%	142,000	Premium	Up to 1000W
	Type T	B3-U3-G3	40,763	42,699	45,976					
	Type FA	B3-U3-G3	40,880	42,822	46,109					
480W	Type 3	B4-U3-G5	60,214	63,074	67,915					
	Type 4	B4-U3-G5	60,690	63,572	68,451					
	Type 5	B5-U3-G5	63,634	66,657	71,773	70	88%	142,000	Premium	Up to 1000W
	Type T	B4-U3-G4	64,537	67,603	72,792					
	Type FA	B4-U3-G4	64,724	67,798	73,002					

NOTE: Mounting accessories are ordered separately

† Lumen maintenance data is based on LED testing per IESNA LM-80 and projected per IESNA TM-21

Photometrics

480W - 30' mounting height. Divisions are multiples of mounting height.

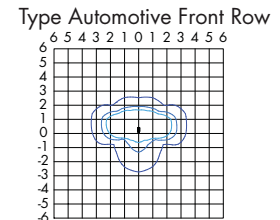
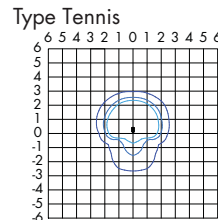
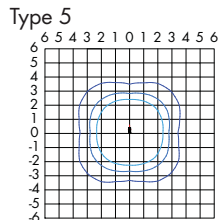
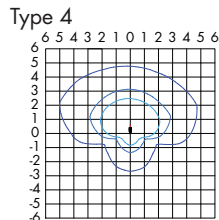
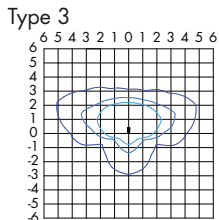

Accessories

Mounting Accessories

- EN14628 - Round pole straight arm - bronze
- EN27395 - Square pole mount - bronze
- EN36717 - Adjustable slipfitter - bronze
- EN38159 - Mast arm (Horizontal tenon) - bronze

Photocell Accessories

- PH12415 - 3-Pin Twist lock photocell (120-277V)
- PH81156 - 3-Pin Twist lock photocell (480V)
- PH87145 - 3-Pin Twist lock photocell (347V)
- PH81975 - Replacement shorting cap

Wireless Controls Accessories

- WCN-7P-UNV - Synapse® Twist lock controller
- WCG-450 - Synapse® Gateway

Miscellaneous Accessories

- SP12714 - 120-277V surge protector
- SP12826 - 347-480V surge protector
- PH46224 - Wireless program tool for M12 & M34 options

Factory Installed Options

- "-SH" - Backlight Shield (EN68320)
- "-M12" - Wireless BLE Sensor 120-277V (PH43982) + Sensor Lens (PH47512)
- "-M34" - Wireless Sensor (347-480V (PH52149) + Sensor Lens (PH47512)



LED AREA LIGHTING

Venture Lighting's color temperature selectable and wattage selectable LED Area Light is capable of changing to 3 different CCT settings (3000K, 4000K, 5000K) and 3 different wattage settings (3 light levels) with a simple switch. These field-adjustable fixtures are preset to the highest wattage and 5000K CCT. The flexible selection capability allows for a cost-effective method to reduce stocking inventory by 88% (1 SKU instead of 9). This is an ideal choice for commercial, industrial, or retail applications.

Select-Pro Area Lights Ordering & Model Number Information

Choose nomenclature that suits application. Example: **AR1-300WT3-ABZ**

AR1 -	300	W	T3	-	A	BZ
Series	Wattage	CCT	Distribution		Voltage	Finish

AR1 - Venture's Select-Pro LED Area Fixture
 150 - 100/120/150W
 300 - 200/250/300W
 W - CCT Selectable
 T3 - Type 3
 T4 - Type 4
 A - 120-277V
 BZ - Bronze



Performance Data

Wattage	Distribution Type	BUG	3000K Lumens	4000K Lumens	5000K Lumens	DLC Model Number	CRI	Lumen Maint. @50,000 hours†	Calc. L70@25°C Amb.(hrs)†
100W	Type 3	B3-U0-G3	12,443	13,672	13,531	AR1 UNV-150WT3-BZW50	≥70	90%	169,000
	Type 5	B4-U0-G5	12,362	13,395	13,153	AR1 UNV-150WT5-BZW50			
120W	Type 3	B3-U0-G3	14,932	16,407	16,237	AR1 UNV-150WT3-BZW50			
	Type 5	B4-U0-G5	14,834	16,074	15,784	AR1 UNV-150WT5-BZW50			
150W	Type 3	B3-U0-G3	18,665	20,509	20,296	AR1 UNV-150WT3-BZW50			
	Type 5	B4-U0-G5	18,543	20,093	19,729	AR1 UNV-150WT5-BZW50			
200W	Type 3	B4-U0-G4	25,213	27,608	27,437	AR1 UNV-300WT3-BZW50	≥70	90%	169,000
	Type 5	B5-U0-G2	25,121	27,021	26,527	AR1 UNV-300WT5-BZW50			
250W	Type 3	B4-U0-G4	31,516	34,510	34,296	AR1 UNV-300WT3-BZW50			
	Type 5	B5-U0-G2	31,402	33,777	33,159	AR1 UNV-300WT5-BZW50			
300W	Type 3	B4-U0-G4	37,820	41,413	41,155	AR1 UNV-300WT3-BZW50			
	Type 5	B5-U0-G2	37,682	40,532	39,791	AR1 UNV-300WT5-BZW50			

NOTE: Mounting accessories are ordered separately

† Lumen maintenance data is based on LED testing per IESNA LM-80 and projected per IESNA TM-21



Photometrics

Fixtures mounted at 30 feet. Grid is multiples of mounting height.

150W T3

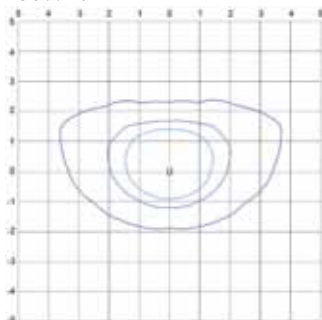

150W T5

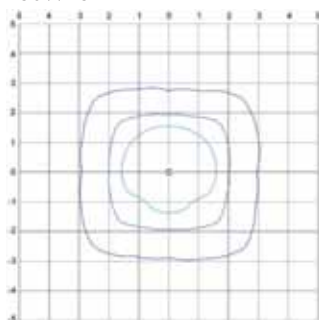

300W T3

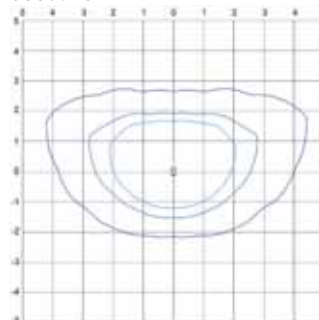

300W T5

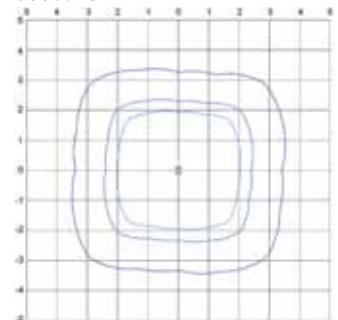

Accessories

Mounting Accessories

- AC17341 - 100-300W Adjustable slipfitter
- AC17343 - 100-150W U-bracket
- AC17345 - 200-300W U-bracket
- AC17347 - 100-300W Round & square pole arm

Misc. Accessories

- PH12415 - 3-Pin Twist lock photocell (120-277V)
- PH81975 - Replacement shorting cap
- PH53207 - Screw-in programmable microwave Motion/Dim/Photocell sensor
- PH52186 - Motion/Dim/Photocell sensor handheld programmer
- SP12714 - 120-277V surge protector
- AC17622 - Backlight shield for 100-150W, Type 3 (3) distribution only
- AC17624 - Backlight shield for 200-300W, Type 3 (T3) distribution only



SURFACE MOUNT CANOPY LIGHTING

Select-Pro Surface Mount Canopy

Model Number	3000K			4000K			5000K			CRI	Lumen Maint. @50,000 hours†	Calc. L70@25°C Amb.(hrs)†	DLC Qualified	DLC Model Number
	Wattage	Lumen Output	LPW	Lumen Output	LPW	Lumen Output	LPW							
CP12789	40	5000	125	5450	136	5400	135	≥80	94%	319,000	Premium	CPS40SP2-WHP1W50		
	30	3750	125	4100	136	4050	135							
	20	2500	125	2750	136	2700	135							
CP41916	75	9250	123	10000	133	9950	133	≥80	94%	293,000	Premium	CPS75SP2-WHP1W50		
	60	7400	123	8000	133	7950	133							
	40	4950	123	5350	133	5300	133							

† Lumen maintenance data is based on LED testing per IESNA LM-80 and projected per IESNA TM-21



Photometrics

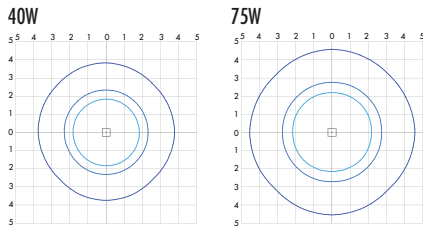

10ft mounting height
Divisions are multiples of mounting height

Accessories (Order as separate line items)

- PH12568 - Programmable microwave motion/dim/ photocell sensor
- AC13752 - Sensor handheld programmer
- SP12714 - Surge protector (120-277V)
- LN19342 - 160 Degree lens for 40W
- LN19346 - 160 Degree lens for 75W
- AC31925 - Tamper-resistant screws

Add "-EM" to order code for factory installed battery backup
Add "-S7" to order code for factory installed Programmable Microwave Motion/Dim/Photocell Sensor (PH12568)
Add "-TRS" to order code for factory installed tamper-resistant screws (AC31925)

Dimensions

20-40W Select-Pro Canopy
Weight: 3.85 lbs (1.75 kg)

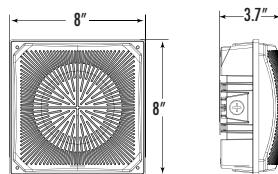

75W Select-Pro Canopy
Weight: 6.12 lbs (2.78 kg)

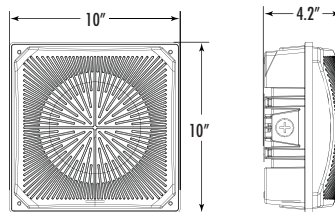

Breezeway

Wattage	Order Code	Lumen Output	Color Temp.	CRI	Lumen Maint. @50,000 hours†	Calc. L70@25°C Amb.(hrs)†	Fixture Color	DLC Qualified	Replaces Existing HID Wattage	DLC Model Number
23W	CP71667	2670	5000K	≥70	98%	>500,000	White	-	70W	-

† Lumen maintenance data is based on LED testing per IESNA LM-80 and projected per IESNA TM-21

Photometrics

Breezeway

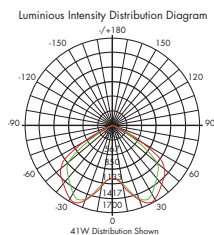

Dimensions

Breezeway
Weight: 6.8 lbs (3.08 kg)

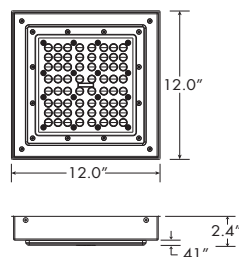

Accessories (Order as separate line items)

- SP12714 - Surge protector (120-277V)



LED PARKING GARAGE LIGHTING

SafeLit

120-277V

Wattage	Order Code	Lumen Output	Color Temp.	CRI	Lumen Maint. @50,000 hours [†]	Calc.L70@25°C Amb.(hrs) [†]	Fixture Color	DLC Qualified	Replaces Existing HID Wattage	DLC Model Number
84W	CP13491	8360	4000K	75+	87%	129,000	Bronze	-	250W	-
84W	CP48164	8300	5000K	75+	87%	129,000	Bronze	-	250W	-

SafeLit

347-480V

Wattage	Order Code	Lumen Output	Color Temp.	CRI	Lumen Maint. @50,000 hours [†]	Calc.L70@25°C Amb.(hrs) [†]	Fixture Color	DLC Qualified	Replaces Existing HID Wattage	DLC Model Number
84W	CP18416	8320	4000K	70	87%	129,000	Bronze	-	250W	-
84W	CP29871	8300	5000K	70	87%	129,000	Bronze	-	250W	-

[†] Lumen maintenance data is based on LED testing per IESNA LM-80 and projected per IESNA TM-21



Benefits and Features

- Polycarbonate optics provide up-light to eliminate "cave effect"
- Operating temperature range of -40° C to 40° C
- 10KA surge protection
- 0-10V DC dimming standard to maximize energy savings
- Surface or pendant mount
- Factory installed motion/dimming/photocell sensor option available



NOTE: shown with factory installed motion sensor

Photometrics

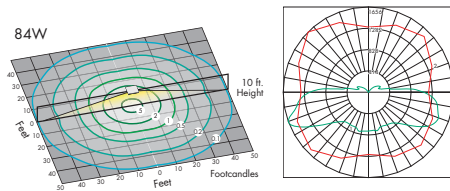

Dimensions

84W: Weight: 21 lbs (9.53 kg)

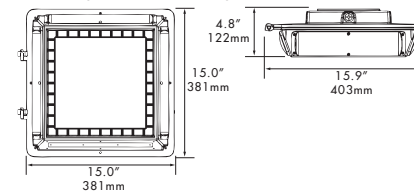

Accessories (Order as separate line items)

- PH46224 - Wireless program tool
 - PH43982 - Wireless BLE Program Motion/Photocell/Dimming Sensor
 - PH18673 - Sensor lens for garage (low mounting height) applications
 - SP12714 - Surge protector (120-277V)
 - BB24624 - Battery Backup (120-277V only)
 - AC57163 - conduit adapter for battery back-up
- For a factory installed motion/dim/photocell sensor add "-M12" after order code for 120-277V
For a factory installed motion/dim/photocell sensor add "-M34" after order code for 347-480V



LED PARKING GARAGE LIGHTING

Greenway *with sensor*

Wattage	Order Code	Lumen Output	Color Temp.	CRI	Lumen Maint. @50,000 hours [†]	Calc. L70@25°C Amb.(hrs) [†]	Fixture Color	DLC Qualified	Replaces Existing HID Wattage	DLC Model Number
41W	CP97593	4600	5000K	70+	98%	>500,000	White	-	100W	-
54W	CP38074	6160	5000K	70+	98%	>500,000	White	-	175W	-

[†] Lumen maintenance data is based on LED testing per IESNA LM-80 and projected per IESNA TM-21

Benefits and Features

- Heavy-duty aluminum housing with a durable powder coat finish
- Occupancy and daylight sensor pre-installed
- High-performance, UV stabilized acrylic optics
- Optical chamber is sealed and gasketed
- Operating temperature range of -40° C to 40° C
- 10KA surge protection
- 5 year warranty
- Up to 76% Energy Savings
- Rated for wet locations
- Universal 120-277V 50/60 Hz input
- 0-10V DC dimming standard to maximize energy savings
- Can be surface or pendant mounted



Photometrics

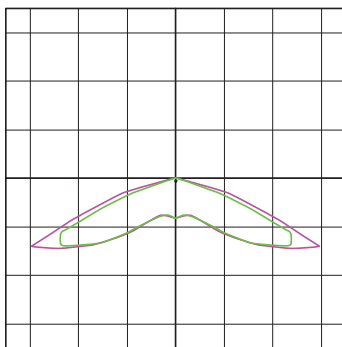

Wide Distribution*

Max. C0-60° H
0° H
90° H

Dimensions

Greenway
With Sensor
Weight: 7.5 lbs (3.40 kg)

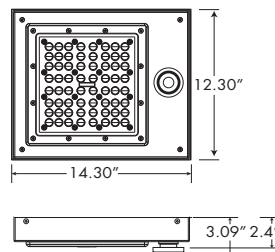

Accessories (Order as separate line items)

- PH46224 Wireless program tool



GAS STATION CANOPY LIGHTING

Gas Station Canopy

Wattage	Order Code	Lumen Output	Color Temp.	CRI	Lumen Maint. @50,000 hours†	Calc.L70@25°C Amb.(hrs)†	Fixture Color	DLC Qualified	Replaces Existing HID Wattage	DLC Model Number
150W	CP20297	21057	5000K	80+	90%	174,000	White	Premium	400W	CPT-150SAM-WH50

† Lumen maintenance data is based on LED testing per IESNA LM-80 and projected per IESNA TM-21

Benefits and Features

- Constructed from heavy-duty aluminum
- Designed for surface mounting
- Low profile, lightweight design
- Vandal resistant polycarbonate lens
- Operating temperature range of -40° C to 40° C
- DesignLights Consortium® (DLC) Premium qualified
- 5 year warranty
- IP65 rated for wet locations



Photometrics

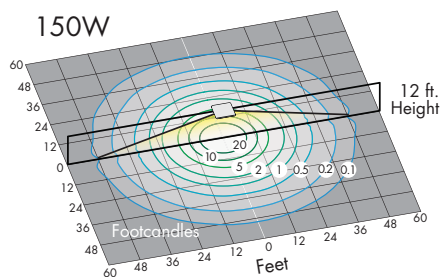

Dimensions

Weight: 17 lbs (7.7 kg)

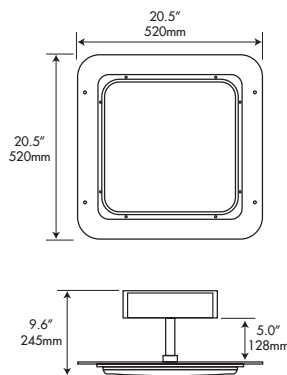

Accessories (Order as separate line items)

- SP12714 - Surge protector (120-277V)



LED RECESSED CANOPY LIGHTING

Low Glare Cascade

Wattage	Order Code	Lumen Output	Color Temp.	CRI	Lumen Maint. @50,000 hours †	Calc. L70@25°C Amb.(hrs) †	Fixture Color	DLC Qualified	Replaces Existing HID Wattage	DLC Model Number
21W	CP12609	3300	4000K	≥70	98%	>190,000	White	Premium	Up to 100W	CPC-03N-25LNA-WHAC
21W	CP14183	3300	5000K	≥70	98%	>190,000	White	Premium	Up to 100W	CPC-03C-25LNA-WHAC
27W	CP13382	4100	4000K	≥70	98%	>190,000	White	Premium	Up to 150W	CPC-03N-45LNA-WHAC
27W	CP17031	4100	5000K	≥70	98%	>190,000	White	Premium	Up to 150W	CPC-03C-45LNA-WHAC
44W	CP32916	6600	4000K	≥70	98%	>190,000	White	Premium	Up to 250W	CPC-03N-60LNA-WHAC
44W	CP33187	6600	5000K	≥70	98%	>190,000	White	Premium	Up to 250W	CPC-03C-60LNA-WHAC
53W	CP46127	8200	4000K	≥70	98%	>190,000	White	Premium	Up to 320W	CPC-03N-80LNA-WHAC
53W	CP49016	8200	5000K	≥70	98%	>190,000	White	Premium	Up to 320W	CPC-03C-80LNA-WHAC

NOTE: † Lumen maintenance data is based on LED testing per IESNA LM-80 and projected per IESNA TM-21

Benefits and Features

- Heavy-duty aluminum housing with a durable powder coat finish
- High-performance, UV stabilized acrylic optics
- Optical chamber is sealed and gasketed
- Operating temperature range of -40° C to 40° C
- 10KA surge protection
- DesignLights Consortium® (DLC) qualified
- 5 year warranty
- Up to 76% Energy Savings
- Universal 120-277V 50/60 Hz input
- 0-10V DC dimming standard to maximize energy savings



Photometrics

Mounted at 10ft
Grid is multiples of Mounting Height

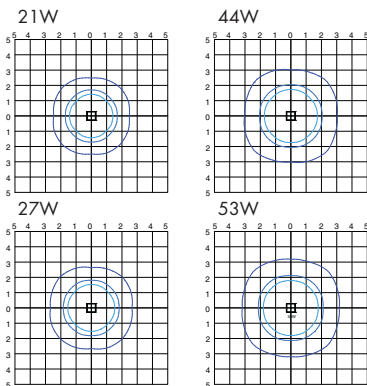

Dimensions

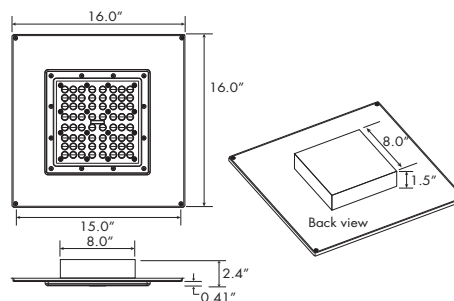

Accessories (Order as separate line items)

- SP12714 - Surge protector (120-277V)



IP66



TENNIS LIGHTING SOLUTIONS

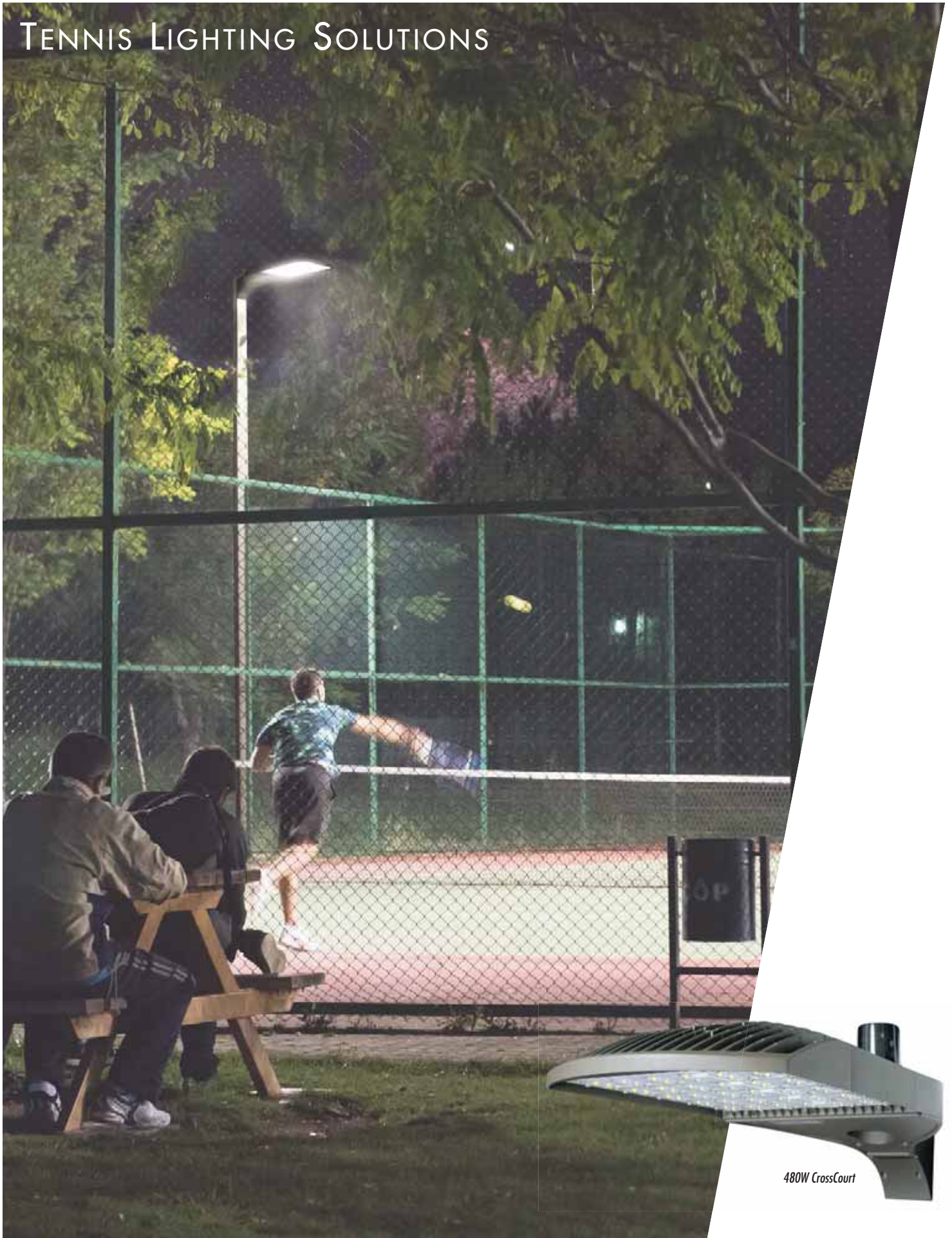

480W CrossCourt



CROSSCOURT TENNIS LIGHTING

Low Watt CrossCourt

Ordering & Model Number Information

Choose nomenclature that suits application. Example: **ENV-200CTT-ABZ-M12**

ENV-	200	C	TT-	A	BZ-	SH	M12
Fixture Type	Wattage	Color Temp.	Optics	Voltage	Fixture Finish	Shield	Options

- ENV - Venture's LED Tennis Fixture
- 150 - 150W
 200 - 200W
- W- 3000K
 B - 3500K
 N - 4000K
 C - 5000K
- TT - Tennis
 A - 120-277V
 B - 347-480V
- BZ - Bronze
 SH - Backlight shield[†]
- "Blank" - No backlight shield
 "Blank" - No motion sensor
- M12 - 120-277V motion sensor
 M34 - 347-480V motion sensor

Notes: Other fixture finish colors available, contact for details



Performance Data

Wattage	Lumen Output	Color Temp.	CRI	Lumen Maint. @50,000 hours [†]	Calc. L70@25°C Amb.(hrs) [†]	Fixture EPA Color	Amperage Draw (A)	Replaces Existing HID Wattages
							120V 277V 347V 480V	
150W	17100	4000K	70	99%	>500,000	0.70 Bronze	1.30 0.55 0.45 0.32	250W V, 400W H
150W	17200	5000K	70	99%	>500,000	0.70 Bronze	1.30 0.55 0.45 0.32	250W V, 400W H
200W	24000	4000K	70	99%	>500,000	0.78 Bronze	1.70 0.73 0.58 0.43	400W V, 1000W H
200W	24150	5000K	70	99%	>500,000	0.78 Bronze	1.70 0.73 0.58 0.43	400W V, 1000W H

NOTE: † Lumen maintenance data is based on LED testing per IESNA LM-80 and projected per IESNA TM-21

Photometrics

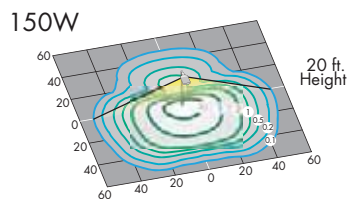

Wattage	B-U-G Rating
150W	B3-U0-G2
200W	B3-U0-G2

Dimensions

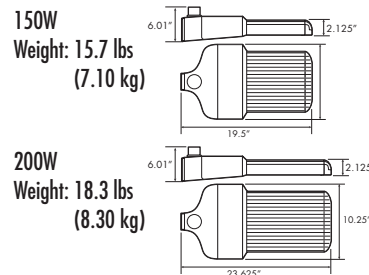

Accessories

Mounting Accessories for 150W through 200W

- EN14178 - Round pole straight arm - bronze
- EN26814 - Square pole mount - bronze
- EN35512 - Adjustable slipfitter - bronze
- EN38419 - Mast arm (Horizontal tenon) - bronze
- EN47832 - Wall mount - bronze

Wireless Controls Accessories

- WCN-7P-UNV - Synapse® Twist lock controller
- WCG-450 - Synapse® Gateway

Factory Installed Options

- "-SH" - Backlight Shield (EN67410)
- "-M12" - Wireless BLE Sensor 120-277V (PH43982) + Sensor Lens (PH47512)
- "-M34" - Wireless Sensor (347-480V (PH52149) + Sensor Lens (PH47512)



High Watt CrossCourt Performance Data

Wattage	Distribution Type	BUG	3000K Lumens	4000K Lumens	5000K Lumens	CRI	Lumen Maint. @50,000 hours†	Calc. L70@25°C Amb.(hrs)†	DLC Qualified	Replaces Existing HID Wattages
300W	Type 3	B3-U3-G5	38,032	39,838	42,896	70	88%	142,000	Premium	Up to 1000W
	Type 4	B3-U3-G5	38,332	40,153	43,235					
	Type 5	B5-U3-G4	40,192	42,101	45,333					
	Type T	B3-U3-G3	40,763	42,699	45,976					
	Type FA	B3-U3-G3	40,880	42,822	46,109					
480W	Type 3	B4-U3-G5	60,214	63,074	67,915	70	88%	142,000	Premium	Up to 1000W
	Type 4	B4-U3-G5	60,690	63,572	68,451					
	Type 5	B5-U3-G5	63,634	66,657	71,773					
	Type T	B4-U3-G4	64,537	67,603	72,792					
	Type FA	B4-U3-G4	64,724	67,798	73,002					

NOTE: Mounting accessories are ordered separately
 † Lumen maintenance data is based on LED testing per IESNA LM-80 and projected per IESNA TM-21

Benefits and Features

- Rugged die cast housing with a durable powder coat finish
- Vandal resistant polycarbonate lens
- Optical chamber is sealed and gasketed
- Factory installed motion sensor available
- Operating temperature range of -40° C to 40° C
- 10kA surge protection
- UL Listed for wet locations
- Universal 120-277V 50/60 Hz input or 347-480V input
- Each fixture will be supplied with a 7-pin receptacle and a shorting cap
- Reduced glare
- Superior spill light control
- Longer product life - Reduced maintenance costs
- Ability to illuminate individual courts when coupled with controls
- Lower visual impact on the surrounding environment
- 0-10V DC dimming standard to maximize energy savings

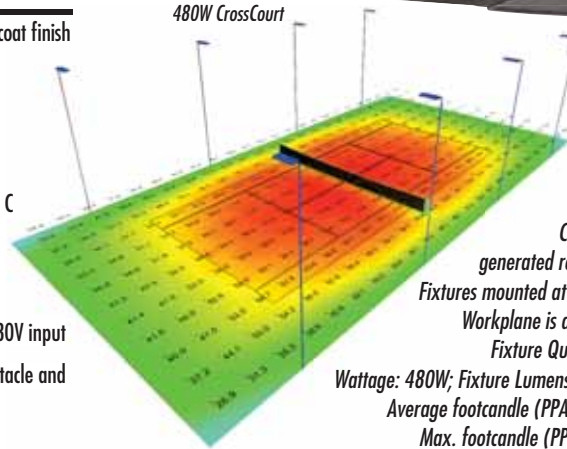

Computer generated rendering
 Fixtures mounted at 30' AFG
 Workplane is at 3' AFG
 Fixture Quantity: 8
 Wattage: 480W; Fixture Lumens: 72792
 Average footcandle (PPA): 65.32
 Max. footcandle (PPA): 75.7



Photometrics

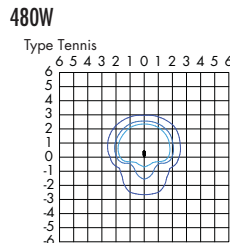

NOTE: 30' mounting height.
 Divisions are multiples of mounting height.

Dimensions

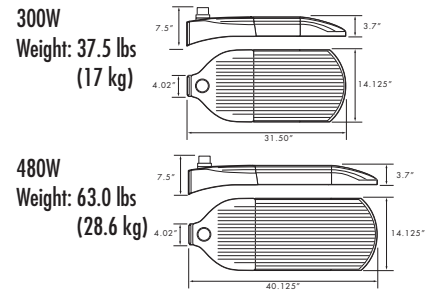

Accessories (Order as separate line items)

Mounting Accessories

- EN14628 - Round pole straight arm - bronze
- EN27395 - Square pole mount - bronze
- EN36717 - Adjustable slipfitter - bronze
- EN38159 - Mast arm (Horizontal tenon) - bronze

Photocell Accessories

- PH12415 - 3-Pin Twist lock photocell (120-277V)
- PH81156 - 3-Pin Twist lock photocell (480V)
- PH87145 - 3-Pin Twist lock photocell (347V)
- PH81975 - Replacement shorting cap

Wireless Controls Accessories

- WCN-7P-UNV - Synapse® Twist lock controller
- WCG-450 - Synapse® Gateway

Miscellaneous Accessories

- SP12714 - 120-277V surge protector
- SP12826 - 347-480V surge protector
- PH46224 - Wireless program tool for M12 & M34 options

Factory Installed Options

- "-SH" - Backlight Shield (EN68320)
- "-M12" - Wireless BLE Sensor 120-277V (PH43982) + Sensor Lens (PH47512)
- "-M34" - Wireless Sensor (347-480V (PH52149) + Sensor Lens (PH47512)



LED RETROFIT LAMPS



54W LED Retrofit lamp



LED RETROFIT LAMPS

Medium Base Lamps

Wattage	Order Code	Base Type	Lumen Output	Color Temperature	CRI	Lumens per Watt	Rated Life (hrs)	Replaces Existing HID Wattages	UL 1993 Certified	UL 1598C Certified
12W	LP23242	E26	1700	4000K	80	140	50,000	50W	Yes	Yes
14W	LP26748*	E26	1680	3000K	80	120	50,000	70W	Yes	-
18W	LP31517*	E26	2160	3000K	80	120	50,000	100W	Yes	-
18W	LP21358	E26	2600	4000K	80	140	50,000	100W	Yes	Yes
22W	LP36178*	E26	2640	3000K	80	120	50,000	175W	Yes	-
24W	LP10829	E26	3350	4000K	80	140	50,000	175W	Yes	Yes
27W	LP41072	E26	3850	4000K	80	140	50,000	175W	Yes	Yes
36W	LP38326	E26	5075	4000K	80	140	50,000	175W	Yes	Yes
54W	LP48791*	E26	7600	4000K	80	135	50,000	175W	Yes	-
54W	LP15961	E26	7600	4000K	80	140	50,000	250W	Yes	Yes
54W	LP21921	E26	7700	5000K	80	142	50,000	250W	Yes	Yes

Mogul Base Lamps

Wattage	Order Code	Base Type	Lumen Output	Color Temp.	CRI	Lumens per Watt	Rated Life (hrs)	Replaces Existing HID Wattages	UL 1993 Certified	UL 1598C Certified	DLC Qualified	DLC Model Number
27W	LP72163	EX39	3850	4000K	80	140	50,000	175W	Yes	Yes	-	-
27W	LP75409	EX39	3900	5000K	80	142	50,000	175W	Yes	Yes	-	-
36W	LP78106*	EX39	5000	4000K	80	140	50,000	175W	Yes	Yes	-	-
36W	LP39014	EX39	5075	4000K	80	140	50,000	175W	Yes	Yes	-	-
36W	LP39831	EX39	5150	5000K	80	142	50,000	175W	Yes	Yes	-	-
45W	LP48460*	E39	5400	4000K	80	120	50,000	175W	Yes	Yes	-	-
45W	LP94209*	EX39	6300	4000K	80	140	50,000	175W	Yes	Yes	-	-
45W	LP52816	EX39	6300	4000K	80	140	50,000	175W	Yes	Yes	-	-
45W	LP26126*	E39	5400	5000K	80	120	50,000	175W	Yes	Yes	-	-
54W	LP18193	EX39	7600	4000K	80	140	50,000	250W	Yes	Yes	-	-
54W	LP18739	EX39	7700	5000K	80	142	50,000	250W	Yes	Yes	-	-
100W	LP20816	EX39	14,000	4000K	80	140	50,000	400W	Yes	Yes	-	-
100W	LP31437	EX39	14,200	5000K	80	142	50,000	400W	Yes	Yes	-	-

Note: * While supplies last

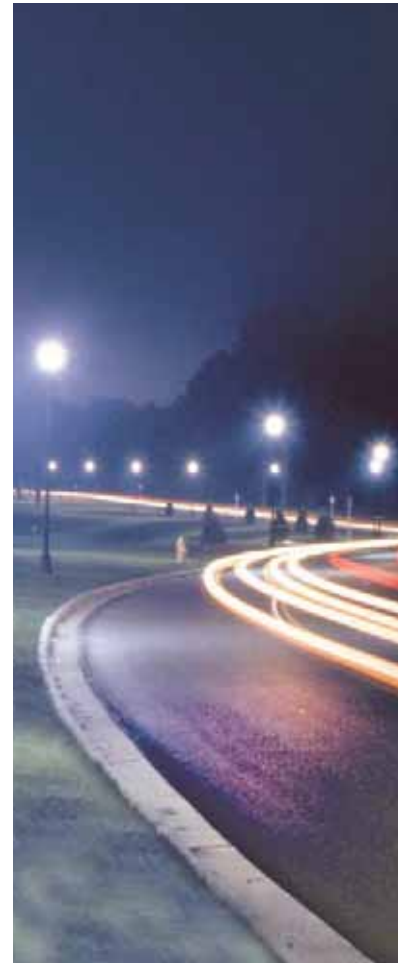

Dimensions



Benefits and Features

- Universal Burn Position - Omnidirectional (base-up/base-down/horizontal operation)
- Easy installation, medium and mogul bases available
- E39/EX39 mogul based lamps are DLC Qualified
- Integrated driver with PF ≥ 90% and THD ≤ 20%
- 5 year warranty

Wiring

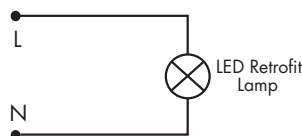

Easy to install - bypass ballast and provide voltage directly to lamp

Accessories (Order as separate line items)

- SP12714 - Surge protector (120-277V)



Watts	Base	A	B
12W	E26	4.92" (125mm)	2.36" (60mm)
18W	E26	5.71" (145mm)	2.36" (60mm)
24W	E26	7.52" (191mm)	2.56" (65mm)
27W	E26	6.69" (170mm)	2.36" (60mm)
27W	EX39	7.32" (186mm)	2.36" (60mm)
36W	E26	7.56" (192mm)	3.35" (85mm)
36W	EX39	8.43" (214mm)	3.35" (85mm)
45W	EX39	9.96" (253mm)	3.35" (85mm)
54W	E26	9.10" (231mm)	3.35" (85mm)
54W	EX39	9.96" (253mm)	3.35" (85mm)
100W	EX39	10.43" (265mm)	5.12" (130mm)



SPECIALTY LED RETROFIT LAMPS

Directional Mogul Base Lamps

Wattage	Order Code	Base Type	Lumen Output	Color Temperature	CRI	Rated Life (hrs)	Distribution	Power Factor	THD
54W	LP27189	E39	6500	5000K	70	50,000	Type V	>0.90	<20%
115W	LP31725	E39	13500	4000K	70	50,000	Type V	>0.90	<20%
115W	LP38561	E39	13500	5000K	70	50,000	Type V	>0.90	<20%

Benefits and Features

- Simple energy saving solution providing significant maintenance savings
- Integrated driver design makes an ideal upgrade from traditional technologies
- Up to 5 times longer life and 80% energy savings compared to HID
- 5 year warranty
- Horizontal burn position
- Easy installation
- Reduced maintenance costs
- Perfect for applications such as area, flood and wallpack lighting
- Rotatable base for easy positioning



Photometrics

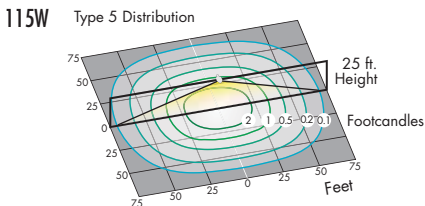
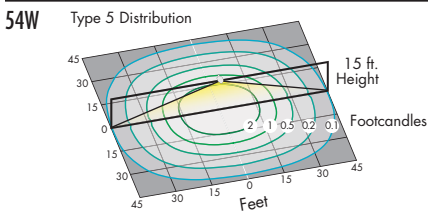

Dimensions

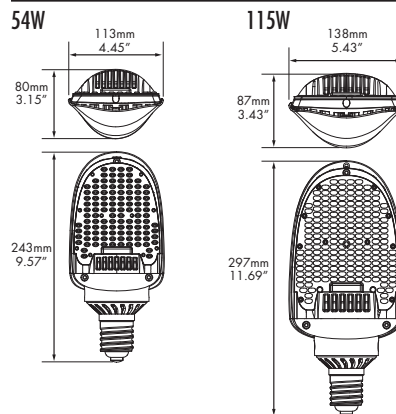

Wiring

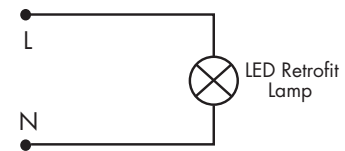

Easy to install - bypass ballast and provide voltage directly to lamp

Accessories (Order as separate line items)

- SP12714 - Surge protector (120-277V)



SPECIALTY LED RETROFIT LAMPS

Lowbay - Retrofit Lamp

Wattage	Order Code	Base Type	Lumen Output	Color Temperature	CRI	Rated Life (hrs)	Power Factor	THD	DLC Model Number
40W	LP91312	E26	4800	4000K	80	50,000	>0.90	<20%	-
40W	LP27198	EX39	4800	4000K	80	50,000	>0.90	<20%	-

NOTE: Other color temperatures available: 2700K, 3000K, 3500K and 5000K, contact for lead time

Benefits and Features

- Energy saving replacement for 175W MH or HPS
- Up to 5 times longer life and 80% energy savings compared to HID
- 5 year warranty
- Easy installation
- Reduced maintenance costs
- Perfect for applications such as lowbays, canopies, garages, and general illumination



Photometrics

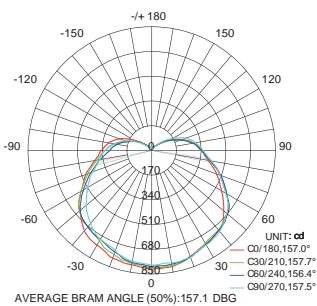

Dimensions

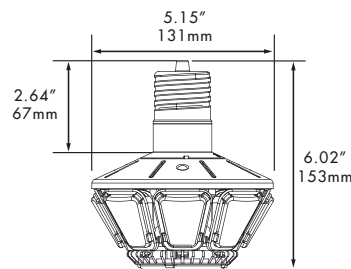

Dimensions the same for both EX39 and E26 base versions

Wiring

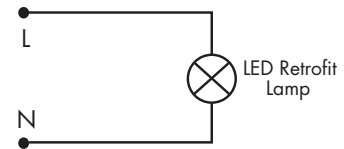

Easy to install - bypass ballast and provide voltage directly to lamp

Accessories (Order as separate line items)

- SP12714 - Surge protector (120-277V)



WIRELESS CONTROLS & SENSORS

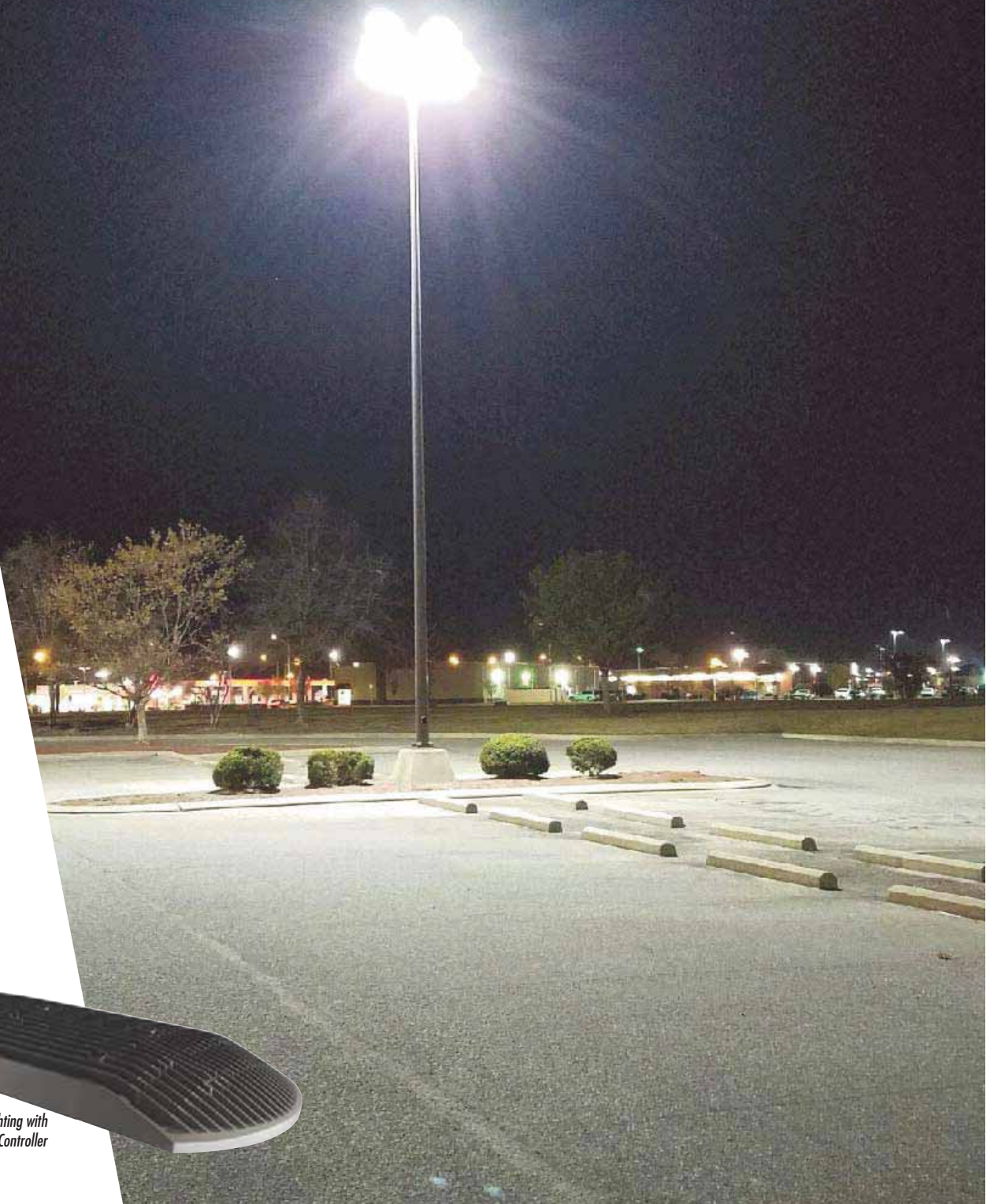

Environ LED Area Lighting with Synapse® Twist Lock Controller





SimplySNAP is a wireless lighting control solution that enables considerable energy savings and lowers operating costs by automating, customizing, and controlling the behavior of lights.

Built for easy installation and use, SimplySNAP doesn't require Internet access and can scale to hundreds of lights, all controlled by a single site controller. SimplySNAP is powered by an encrypted, self-forming, self-healing, 802.15.4 SNAP mesh network and provides a reliable and secure foundation for your lighting network.

SimplySNAP makes commissioning easy with four provisioning options. In addition to manual entry and CSV upload, the Synapse mobile commissioning application, and auto-discovery of unconfigured lights makes commissioning child's play.

Day-to-day operation is just as easy thanks to a browser-based user interface that's accessed through a mobile-friendly Wi-Fi interface. Easy access from a laptop or tablet means your system can be controlled or reconfigured whenever needed. With the optional SimplySNAP Remote Access service, your lighting network can also be managed remotely from anywhere you have an Internet connection.

The system stores power data, alarms, and critical events locally for maintenance and troubleshooting, and provides California Title 24 compliant daily schedules. Occupancy and ambient light sensor integration allows full lighting network customization under a variety of situations.

With programmable schedules and easy setup, SimplySNAP is the perfect solution for lighting control; you just configure it and it runs.

Benefits

- No Internet Required - Site based control
- Web browser based commissioning and control
- Control Individual Fixtures, as well as groups of fixtures based on automated schedules or sensor events
- Secure connection to Site Controller via Wi-Fi and/or LAN
- Automatic software upgrades via encrypted over-the-air communications or USB flash drive
- Graphical representation of power consumption
- Multiple Zones, Behaviors, and Events
- Data and events stored on local Site Controller
- Upgradable to all future SimplySNAP releases

Common Applications

- Parking Lots
- Parking Garages / Decks
- Roadway/Pathway Lighting
- Sports Facilities
- Colleges / Schools

Twist-lock Controller

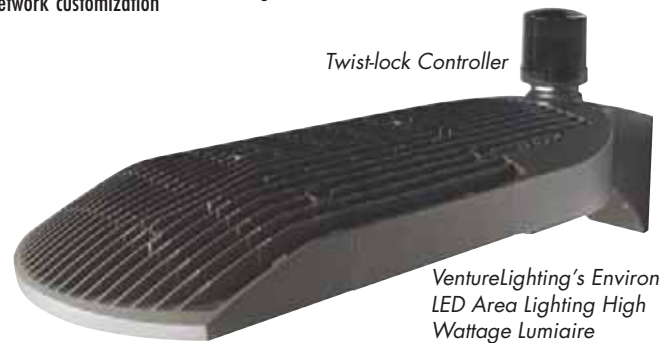

VentureLighting's Environ LED Area Lighting High Wattage Luminaire



Components

Product Type	Part Number	Product Description
Gateway	WCG-450	SimplySNAP Site Controller, WiFi, Verizon LTE, Metal Enclosure
	WCG-450-CBS-5B	Central Base Station - Nema Enclosure, 5-Button Switch, Includes WCG-450
	WCG-BMS-GW	BMS Gateway for SimplySNAP Site Controller, BACnet, Modbus Compatible
Individual Fixture Controllers	WCN-7P-UNV	7-Pin Twistlock Controller, 6kV Surge and Utility Grade Power Monitoring, Integral Photocell, Digital and Analog Sensor Input, 120-277V
Accessories	5B-SW	Switch, USB, 5-Button, Stand Alone
	ANT-8-REM	Remote Mount SNAP Antenna, Outdoor, Staright, 8.0 dBi Gain
	ANT-2-INT	Indoor Articulating Antenna 2.0 dBi Gain
	ANT-1.5-EXT	Outdoor Straight Antenna 1.5 dBi Gain



CONTROLS - LUTRON

To compliment Venture LED indoor lighting fixtures, Venture Lighting offers a range of Lutron wireless sensors & controllers to maximize energy savings in new & existing commercial buildings. Venture Lighting LED fixture that are compatible with Lutron Wireless Lighting Controls, will have this symbol on the page. To complete most lighting solutions Venture Lighting is happy to offer the following Lutron controls. Contact Venture Lighting or your Venture Lighting Representative for more information.



Product Colors Select from these color below



Area Dimming and Sensing

Private office

Dim a group of lights together while also providing manual control. Save additional energy with daylight harvesting.



Simple Switching

Restroom

Occupancy sensors control all lights together by switching lights on and off in response to room occupancy.



Individual fixture dimming and sensing

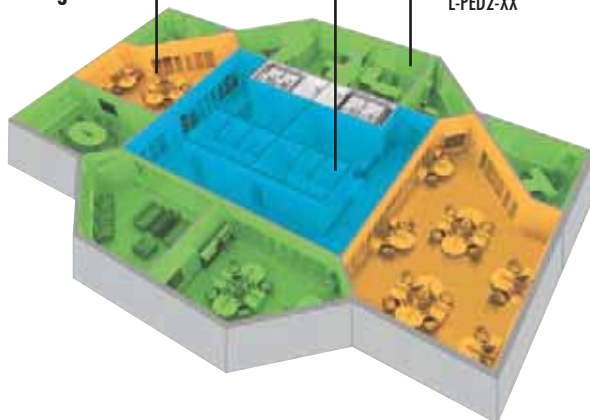

Lutron Controls PowPack - Wireless (RF) Controllers

Part Number	Description
RMJS-16R-DV-B	Control lighting zone in the space, 16 amp, On/ Off
RMJS-5R-DV-B	Control lighting zone in the space, 5 amp, On/ Off
RMJS-8T-DV-B	Control 0-10 V lighting zone in the space, 8 amp, On/ Off, 0-10v dimming
RMJS-CCO1-24-B	Control additional contact closure output, VAV terminal unit
RMJS-20R-DV-B	Control each 20 A receptacle circuit you want to control, 20A receptacle circuit
FCJS-010	Control each fixture in the space, 1 amp per fixture, 0-10v dimming
FCJS-010-BULK8	Control each fixture in the space, 1 amp per fixture, 0-10v dimmingBlack

Lutron Sensors Radio Powr Savr - Occupancy, Vacancy & Daylight Sensors

Part Number	Description
LRF2-OCR2B-P-WH	Ceiling-mount, 360° field-of-view, occupancy/vacancy sensor
LRF2-OWLB-P-WH	Wall-mount, 180° field-of-view, occupancy/vacancy sensor
LRF2-VWLB-P-WH	Wall mount, 180° field-of-view, sensor Vacancy only
LRF2-OKLB-P-WH	Corner-mount, 90° field-of-view, occupancy/vacancy sensor
LRF2-VKLB-P-WH	Corner-mount, 90° field-of-view, vacancy only sensor
LRF2-VHLB-P-WH	Hallway, vacancy only sensor
LRF2-DCRB-WH	Ceiling-mount daylight sensor
DfCSJ-OEM-RF	DALI/EcoSystem In-Fixture RF Module with Integral Occ/Daylight Sensor
DfCSJ-OEM-OCC	DALI/EcoSystem In-Fixture RF Module Only

Lutron Switches Maestro - Wireless Wall Mounted Switches & Dimmers

Part Number	Description
MRF2S-6ANS-XX	Vive Maestro Wireless Switch 6 AMP (Neutral Needed) On/Off
MRF2S-8S-DV-XX	Maestro Wireless 8 Amp Multi-location Switch On/ Off
MRF2S-8ANS-120-XX	8A lighting, 5.8A fan (1/4HP motor), spec grade, 120V (Neutral Needed) On/ Off
MRF2S-6CL-XX	150W dimmable CFL/LED, 600W incandescent, halogen, 600VA MLV, 120V, no neutral
MRF2S-6ELV-XX	600W ELV, 120V (Electric Low Voltage)

Lutron Remotes and Accessories Pico

Part Number	Description
PJ2-2BRL-GXX-L01	2-button with raise/lower
PJ2-2B-GXX-L01	2-button
PJ2-3BRL-GXX-L01	3-button with raise/lower
PJ2-3B-GXX-L01	3-button
CW-1-XX	Claro 1-gang wall plate
CW-2-XX	Claro 2-gang wall plate
PICO-WBX-ADAPT	wireless remote wall box adapter
L-PED1-XX	wireless remote single pedestal
L-PED2-XX	wireless remote double pedestal



Photosensors/Shorting Cap

Order Code	Description	Voltage Range	Product Color
PH56903	Button Photocell(120-277V)	120-277V AC	Black
PH12415	Twist lock photocell (120-277V)	105-305V AC	Blue
PH81156	Twist lock photocell (480V)	480V AC	Yellow
PH87145	Twist lock photocell (347V)	347V AC	Black
PH81975	Twist lock shorting cap	120-480V AC	Black

Dry-Damp Rated Sensors*

Order Code	Description	Voltage Range	Product Color
PH41623	Dry/Damp Rated Motion/On-Off Only Control Sensor	120-277V AC	White
PH77409	Dry/Damp Rated Motion/Photocell/Dimming Control Sensor	120-277V AC	White
PH48156	Dry/Damp Rated Motion/On-Off Only Control Sensor	277-480V AC	White
PH52321	Dry/Damp Rated Motion/Photocell/Dimming Control Sensor	277-480V AC	White

Wet Rated Sensors*

Order Code	Description	Voltage Range	Product Color
PH21458	Wet Rated Motion Only Control Sensor	120-277V AC	White
PH27419	Wet Rated Motion/Photocell/Dimming Control Sensor	120-277V AC	White
PH28534	Wet Rated Motion Only Control Sensor	120-277V AC	Bronze
PH31256	Wet Rated Motion/Photocell/Dimming Control Sensor	120-277V AC	Bronze
PH36512	Wet Rated Motion Only Control Sensor	347-480V AC	White
PH37415	Wet Rated Motion/Photocell/Dimming Control Sensor	347-480V AC	White
PH46145	Wet Rated Motion Only Control Sensor	347-480V AC	Bronze
PH48159	Wet Rated Motion/Photocell/Dimming Control Sensor	347-480V AC	Bronze
PH58143	Wet Rated Motion Only Control Sensor (Long Extension)	347-480V AC	Bronze
PH52171	Wet Rated Motion/Photocell/Dimming Control Sensor (Long Extension)	347-480V AC	Bronze

Wireless Programmed Sensors with lens

Order Code	Description	Voltage Range	Product Color
PH43982	Wireless BLE Programmed Motion/Photocell/Dimming Control Sensor	120-277V AC	White
PH46224	Wireless Programming Tool	N/A	Black
PH47512	Lens for High Mount Applications (Area Lighting)	N/A	White
PH18673	Lens for Low Mount Applications (Parking Garage)	N/A	White
PH52149	Wireless Programmed Motion/Photocell/Dimming Control Sensor	12-32V DC	White

Note: * With high mount lens

Dry and damp rated sensors viewing angle and Wet rated sensors have the same standard lens

High Mount Lens (Area Lighting)

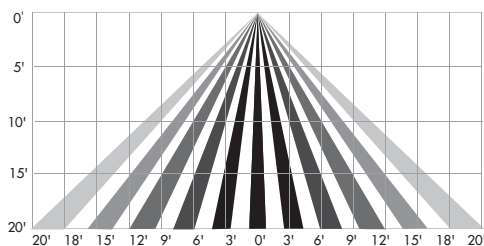

Low Mount Lens (Parking Garage)

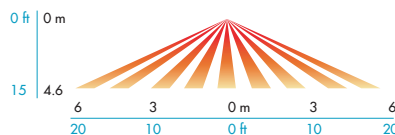
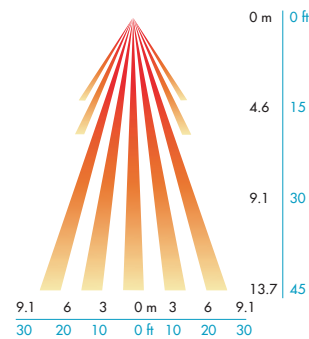
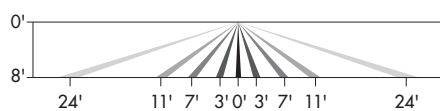

POLE OPTIONS

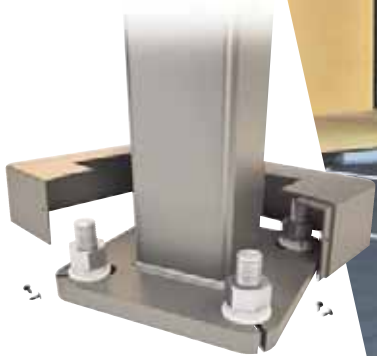

VSS Square Straight Steel Pole



POLE OPTIONS FOR VENTURE LED AREA LIGHTING



Complete the Package

Venture Lighting's LED area lighting luminaires include the VFlood and the Environ families.

VFlood

Available in 121W and 212W, these fixtures are assembled in the U.S.A at our manufacturing center in greater Cleveland, Ohio.

- Rugged die cast housing with a durable powder coat finish
- Vandal resistant polycarbonate lens
- Twist lock photocell receptacle and shorting cap included with the fixture.
- Operating temperature range of -40°C to 40°C
- 10KA surge protection
- DesignLights Consortium® (DLC) qualified
- 0-10V DC dimming standard

Environ

Available in 120W, 150W, 200W, 300W and 480W, these fixtures are assembled in the U.S.A. at our manufacturing center in greater Cleveland, Ohio.

Low profile design featuring long life and low maintenance. Perfect for new construction and easy replacement of existing area lighting fixtures. The robust design paired with a variety of mounting options makes them ideal for locations, such as, retail, parking and street lighting.

- Rugged die cast housing with a durable powder coat finish
- Vandal resistant polycarbonate lens
- Optical chamber is sealed and gasketed
- Capable of adding motion sensor (factory installed)
- Each fixture will be supplied with a 7-pin receptacle and a shorting cap
- Operating temperature range of -40°C to 40°C
- 10kA surge protection
- 5 year warranty
- 80% Energy Savings
- UL Rated for wet locations
- Universal 120-277V 50/60 Hz input or 347-480V input
- 0-10V DC dimming standard to maximize energy savings

Poles Types

Square Straight

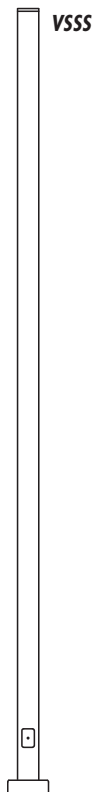

Round Straight

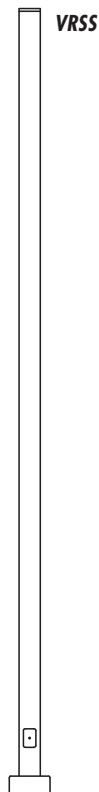

Tapered Round

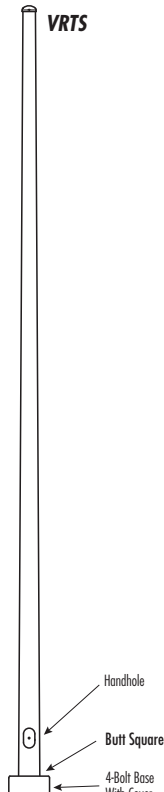

Square Straight



Round Straight

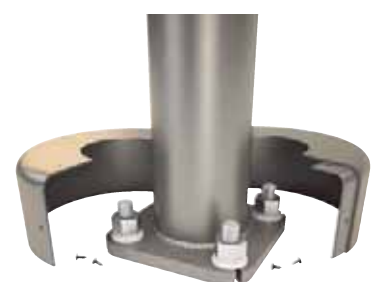

SQUARE STRAIGHT POLE OPTIONS

VSSS

Square Straight Steel Pole No Arm — 4-Bolt Base

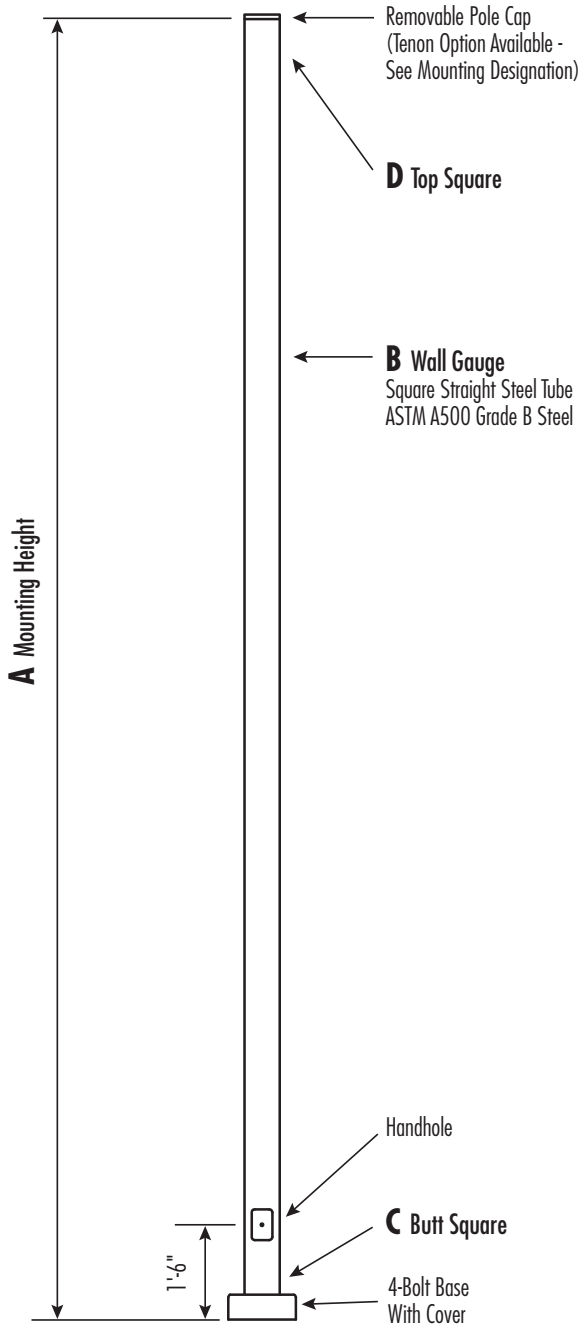

Powder Coated, Galvanized or Powder Coated over Galvanized Finish Per Customer Specification.

C BUTT Sq.	D TOP Sq.	F BOLT CIR. DIA.	G BASE Sq.	H BOLT PROJ.	I BOLT SIZE
4 (11 Gauge)	4	8 - 9	8	3.75	.75 x 17 x 3
4 (7 Gauge)	4	8 - 9	8	3.75	.75 x 30 x 3
5	5	10 - 12	11	4.875	1 x 36 x 4
6	6	11 - 13	12.5	4.875	1 x 36 x 4

WARNING: Do not install light pole without luminaire.

Dimensions in Inches

Pole

Pole shaft shall be weldable-grade, cold-rolled, commercial quality carbon steel tubing conforming to ASTM A500 Grade B. Options include 11 gauge and 7 gauge. All Welds shall conform to AWS D1.2 using ER70S-6 electrodes.

Base Style

4-Bolt Steel Plate Base Flange of fabricated hot rolled carbon steel conforming to ASTM A36 or equivalent (36 ksi minimum yield) with 2-piece Base Cover and attaching hardware. Base Cover will be fabricated from ABS plastic or metal materials.



Handhole

Reinforced, 3" x 5" Handhole with Cover, Stainless Steel Screw and Backbar. A Grounding Provision incorporating a tapped 1/2"-13NC hole will be welded to the handhole frame.



Anchorage

Anchorage Kit will include four (4) L-shaped Steel Anchor Bolts conforming to AASHTO M314-90 Grade 55. Ten inches (10") of threaded end will be galvanized per ASTM A153. Kits will contain eight (8) Hex Nuts, four (4) Lock Washers, and eight (8) Flat Washers (all components Galvanized Steel). A bolt circle template will be provided.

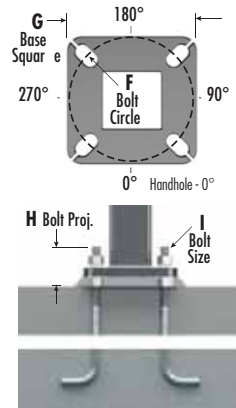

Vibration Damper

If determined necessary by pole manufacturer, a top-mount, field installed First Mode Vibration Damper will be provided. Customer specification of the damper is available.

Mounting Designation

Side Drill Mount

For Side Drill Mount applications specify luminaire type, quantity and orientation. A luminaire drilling template must be supplied at time of order.

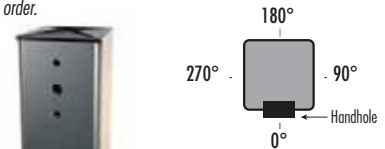

Tenon Mount

For Tenon Mount applications specify both Tenon diameter (2.375", 2.875", 3.5", 4", etc.) and length (3", 4", 5", 6", etc.).



SQUARE STRAIGHT POLE OPTIONS

A Mtg. Hgt.	B WALL GAUGE	C BUTT SQ.	MAX. TOTAL LUMINAIRE WEIGHT (lbs)	MAXIMUM EPA						CATALOG NUMBER	ANCHOR BOLT KIT PART NUMBER
				90	100	110	120	130	140		
10	11	4	385	25.4	20.1	18.7	15.3	12.8	10.7	VSSS10B4-4**	BT82352
12	11	4	340	20.6	16.2	15.0	12.2	10.0	8.3	VSSS12B4-4**	BT82352
14	11	4	305	17.0	13.2	12.1	9.7	7.8	6.3	VSSS14B4-4**	BT82352
15	11	4	290	15.5	11.9	10.9	8.6	6.9	5.5	VSSS15B4-4**	BT82352
16	11	4	275	14.0	10.7	9.7	7.6	6.0	4.7	VSSS16B4-4**	BT82352
18	11	4	250	11.3	8.4	7.6	5.8	4.3	3.2	VSSS18B4-4**	BT82352
20	11	4	230	9.1	6.6	5.8	4.2	2.9	1.9	VSSS20B4-4**	BT82352
20	11	5	285	16.3	12.1	10.9	8.2	6.2	4.5	VSSS20B5-4**	BT82351
20	7	4	290	15.1	11.5	10.5	8.2	6.5	5.1	VSSS20D4-4**	BT82353
20	7	5	410	26.2	20.3	18.6	14.8	11.9	9.6	VSSS20D5-4**	BT82351
22	11	4	215	7.2	4.9	4.3	2.8	1.7	0.8	VSSS22B4-4**	BT82352
22	11	5	260	13.3	9.6	8.5	6.1	4.3	2.8	VSSS22B5-4**	BT82351
22	7	4	265	12.6	9.5	8.6	6.5	5.0	3.7	VSSS22D4-4**	BT82353
22	7	5	370	22.4	17.1	15.6	12.2	9.6	7.5	VSSS22D5-4**	BT82351
25	11	4	200	4.8	2.8	2.3	1.1	-	-	VSSS25B4-4**	BT82352
25	11	5	225	9.7	6.5	5.6	3.5	1.9	0.7	VSSS25B5-4**	BT82351
25	7	4	235	9.7	6.9	6.2	4.5	3.1	2.0	VSSS25D4-4**	BT82353
25	7	5	320	17.7	13.1	11.9	9.0	6.7	4.9	VSSS25D5-4**	BT82351
28	11	5	200	6.6	3.8	3.0	1.3	-	-	VSSS28B5-4**	BT82351
28	7	4	215	7.1	4.8	4.1	2.7	1.5	-	VSSS28D4-4**	BT82353
28	7	5	285	13.8	9.8	8.7	6.2	4.3	2.7	VSSS28D5-4**	BT82351
30	11	5	200	4.8	2.2	1.5	-	-	-	VSSS30B5-4**	BT82351
30	7	4	205	5.7	3.6	3.0	1.6	-	-	VSSS30D4-4**	BT82353
30	7	5	265	11.6	8.0	6.9	4.6	2.8	1.4	VSSS30D5-4**	BT82351
30	7	6	345	19.1	13.6	12.1	8.6	5.9	3.8	VSSS30D6-4**	BT82351
35	7	5	220	7.0	4.0	3.1	1.2	-	-	VSSS35D5-4**	BT82351
35	7	6	280	12.5	8.0	6.7	3.8	1.6	-	VSSS35D6-4**	BT82351
39	7	6	240	8.2	4.2	3.1	0.6	-	-	VSSS39D6-4**	BT82351

Catalog Number System

The catalog number for Venture Lighting poles utilizes the following identification system.

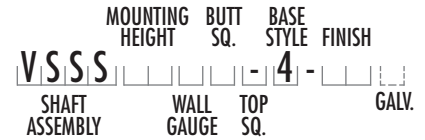

Catalog Number Example -

VSSS 20 D 5 - 4 - BA

Square Straight Steel, 20' Mounting Height,
7 Gauge, 5" Butt Square, No Taper,
4-Bolt Base, Black Powder Coat Finish.

Wall Gauge

B = 11 Gauge
D = 7 Gauge

Butt Square

4 = 4"
5 = 5"
6 = 6"

Top Square

- = No Taper

Base Style

4 = 4-Bolt Anchor Base

Finish

BA = Black Powder Coat
BH = White Powder Coat
BM = Dark Bronze Powder Coat
BV = Dark Green Powder Coat
GC = Gray Powder Coat
** = Specify Finish
OO = Galvanized Only (No Powder Coat)

Galvanization

G = Galvanized

Code "G" to be used only if pole is to be specified "Powder Paint Over Galvanized" or "Galvanized Only".



ABS plastic base covers are standard in all VSSS poles specified in BA-Black, BM-Dark Bronze, and BH-White. VSSS poles specified in all other colors will be manufactured of metal materials. Metal Base Covers for poles in BA, BM and BH can be specified.

EPA Notes:

Effective Projected Area (EPA) in square feet. EPA's calculated using wind velocity (mph) indicated in accordance with 2009 AASHTO LTS-5 using a 25 year design life. Maximum EPA is based on the luminaire weight shown. Increased luminaire weight may reduce the maximum EPA. If weight is exceeded, or if other design life or code is required, please consult the factory.



ROUND STRAIGHT POLE OPTIONS

VRSS

Round Straight Steel Pole No Arm — 4-Bolt Base

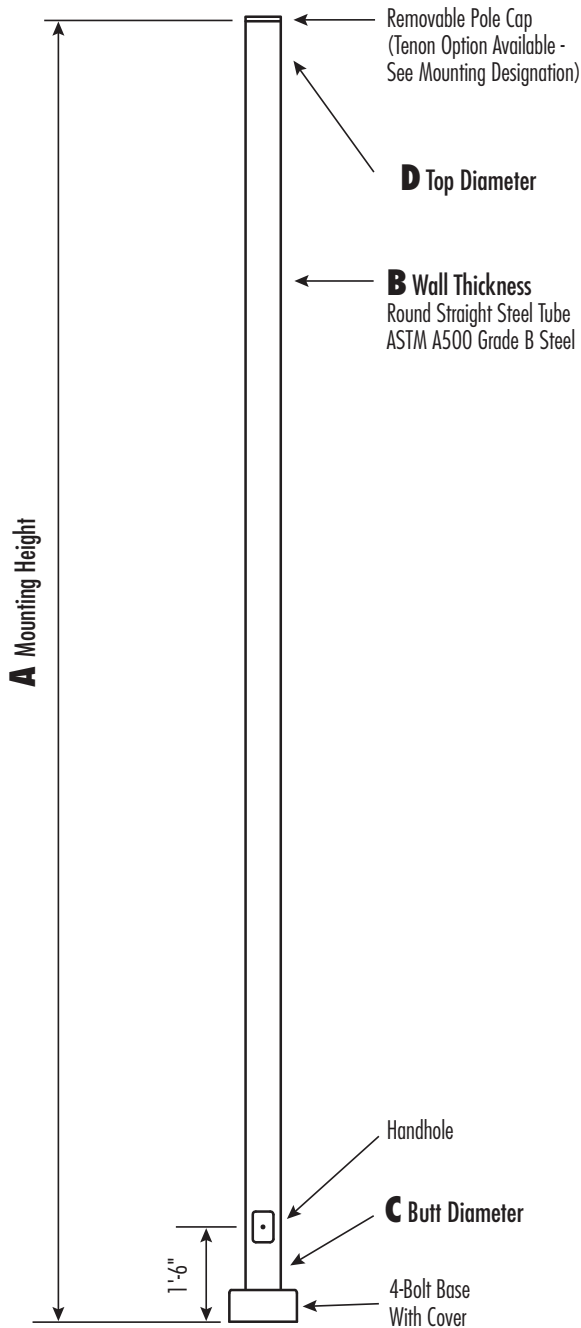

Powder Coated, Galvanized or Powder Coated over Galvanized Finish Per Customer Specification.

C BUTT DIA.	D TOP DIA.	F BOLT CIR. DIA.	G BASE SQ.	H BOLT PROJ.	I BOLT SIZE
3	3	7.5-8.5	8	3.75	.75 x 17 x 3
4	4	7.5-8.5	8	3.75	.75 x 17 x 3
4.5	4.5	7.5-8.5	8	3.75	.75 x 17 x 3
5 (11 Gauge)	5	7.5-8.5	8	3.75	.75 x 17 x 3
5 (7 Gauge)	5	8-9	8.75	4.875	1 x 36 x 4

WARNING: Do not install light pole without luminaire.

Dimensions in Inches

Pole

Pole shaft shall be weldable-grade, cold-rolled, commercial quality carbon steel tubing conforming to ASTM A500 Grade B. Options include 11 gauge and 7 gauge. All Welds shall conform to AWS D1.2 using ER70S-6 electrodes.

Base Style

4-Bolt Steel Base Plate of fabricated hot rolled carbon steel conforming to ASTM A36 or equivalent (36 ksi minimum yield) with 2-piece Base Cover and Attaching Hardware. Base Cover will be fabricated from ABS plastic or metal materials.



Handhole

3" Butt Diameter -
Reinforced, 2" x 4" Handhole with Cover And Stainless Steel Screws. A Grounding Provision incorporating a tapped 1/2"-13NC hole will be welded to the handhole frame.
4+ Butt Diameters -
Reinforced, 3" x 5" Handhole with Cover, Stainless Steel Screw and Back Bar. A Grounding Provision incorporating a tapped 1/2"-13NC hole will be welded to the handhole frame.



Anchorage

Anchorage Kit will include four (4) L-shaped Steel Anchor Bolts conforming to AASHTO M314-90 Grade 55. Ten inches (10") of threaded end will be galvanized per ASTM A153. Kits will contain eight (8) Hex Nuts, four (4) Lock Washers, and eight (8) Flat Washers (all components Galvanized Steel). A bolt circle template will be provided.

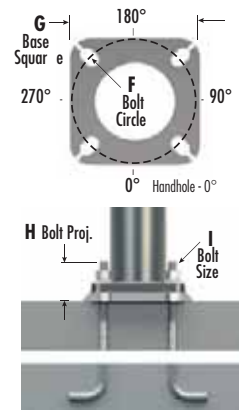

Vibration Damper

If determined necessary by pole manufacturer an internal, factory installed, Second Mode Vibration Damper will be provided. Customer specification of the damper is available.

Mounting Designation

Side Drill Mount

For Side Drill Mount applications specify luminaire type, quantity and orientation. A luminaire drilling template must be supplied at time of order.

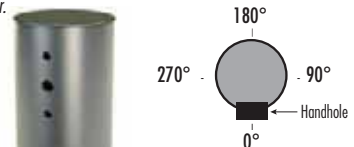

Tenon Mount

For Tenon Mount applications specify both Tenon diameter (2.375", 2.875", 3.5", 4", etc.) and length (3", 4", 5", 6", etc.).



ROUND STRAIGHT POLE OPTIONS

A Mtg. Hgt.	B Wall Gauge	C Butt Dia.	MAX. TOTAL LUMINAIRE WEIGHT (lbs)	MAXIMUM EPA						CATALOG NUMBER	ANCHOR BOLT KIT PART NUMBER
				90	100	110	120	130	140		
8	11	3.0	525	10.2	8.1	7.5	6.2	5.1	4.3	VRSS08B3-4-*	BT82352
8	11	4.0	600	21.5	17.2	16	13.2	11.1	9.5	VRSS08B4-4-*	BT82352
8	11	4.5	600	28.3	22.7	21.1	17.5	14.9	12.8	VRSS08BG-4-*	BT82352
10	11	3.0	440	8.1	6.3	5.8	4.7	3.8	3.1	VRSS10B3-4-*	BT82352
10	11	4.0	600	16.9	13.4	12.4	10.1	8.4	7.1	VRSS10B4-4-*	BT82352
10	11	4.5	600	22.6	18	16.7	13.8	11.6	10	VRSS10BG-4-*	BT82352
12	11	3.0	370	6.5	5	4.5	3.6	2.8	2.2	VRSS12B3-4-*	BT82352
12	11	4.0	600	13.4	10.4	9.6	7.8	6.3	5.3	VRSS12B4-4-*	BT82352
12	11	4.5	600	18.3	14.4	13.3	10.8	9.1	7.8	VRSS12BG-4-*	BT82352
14	11	3.0	320	5.1	3.8	3.4	2.6	2	1.5	VRSS14B3-4-*	BT82352
14	11	4.0	555	10.8	8.3	7.6	6	4.8	4	VRSS14B4-4-*	BT82352
14	11	4.5	600	14.8	11.5	10.6	8.5	7.1	6	VRSS14BG-4-*	BT82352
15	11	4.0	510	9.8	7.4	6.8	5.3	4.1	3.4	VRSS15B4-4-*	BT82352
15	11	4.5	600	13.3	10.2	9.3	7.4	6.2	5.2	VRSS15BG-4-*	BT82352
16	11	3.0	275	4	2.8	2.5	1.8	1.2	0.8	VRSS16B3-4-*	BT82352
16	11	4.0	470	8.9	6.7	6.1	4.7	3.6	2.9	VRSS16B4-4-*	BT82352
16	11	4.5	600	11.9	9.1	8.3	6.5	5.4	4.6	VRSS16BG-4-*	BT82352
18	11	3.0	245	2.9	1.9	1.7	1	-	-	VRSS18B3-4-*	BT82352
18	11	4.0	400	7.2	5.2	4.7	3.5	2.5	1.9	VRSS18B4-4-*	BT82352
18	11	4.5	510	9.8	7.3	6.6	5	4.1	3.4	VRSS18BG-4-*	BT82352
20	11	3.0	225	2	1.1	0.9	-	-	-	VRSS20B3-4-*	BT82352
20	11	4.0	340	5.7	4	3.5	2.4	1.6	1.1	VRSS20B4-4-*	BT82352
20	11	4.5	435	8	5.7	5.1	3.8	3	2.5	VRSS20BG-4-*	BT82352
20	11	5.0	540	10.6	7.8	7.2	5.8	4.8	4	VRSS20B5-4-*	BT82352
22	11	4.5	370	6.4	4.4	3.9	2.7	2.1	1.6	VRSS22BG-4-*	BT82352
22	11	5.0	460	8.7	6.2	5.6	4.5	3.7	3	VRSS22B5-4-*	BT82352
23	7	5.0	600	13.5	10	9.2	7.5	6.2	5.2	VRSS23D5-4-*	BT82351
25	11	4.0	240	2.8	1.5	1.1	-	-	-	VRSS25B4-4-*	BT82352
25	11	4.5	295	4.4	2.7	2.2	1.2	0.8	-	VRSS25BG-4-*	BT82352
25	11	5.0	365	6.3	4.1	3.7	2.9	2.2	1.7	VRSS25B5-4-*	BT82352
25	7	5.0	570	11.2	8.1	7.4	6	4.9	4	VRSS25D5-4-*	BT82351
30	11	4.5	205	1.8	-	-	-	-	-	VRSS30BG-4-*	BT82352
30	11	5.0	245	3.1	1.4	1.1	0.6	-	-	VRSS30B5-4-*	BT82352
30	7	5.0	395	7.1	4.6	4.1	3.1	2.4	1.9	VRSS30D5-4-*	BT82351
35	7	5.0	270	3.8	1.7	1.5	0.9	-	-	VRSS35D5-4-*	BT82351

Catalog Number System

The catalog number for Venture Lighting poles utilizes the following identification system.

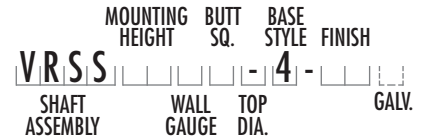

Catalog Number Example -

VRSS 20 B 4 - 4 - BH

Round Straight Steel, 20' Mounting Height, 11 Gauge, 4" Butt Diameter, No Taper, 4-Bolt Base, White Powder Coat Finish.

Wall Gauge

B = 11 Gauge
D = 7 Gauge

Butt Diameter

3 = 3"
4 = 4"
G = 4.5"
5 = 5"

Top Diameter

- = No Taper

Base Style

4 = 4-Bolt Anchor Base

Finish

BA = Black Powder Coat
BH = White Powder Coat
BM = Dark Bronze Powder Coat
BV = Dark Green Powder Coat
GC = Gray Powder Coat
** = Specify Finish
00 = Galvanized Only (No Powder Coat)

Galvanization

G = Galvanized

Code "G" to be used only if pole is to be specified "Powder Paint Over Galvanized" or "Galvanized Only".

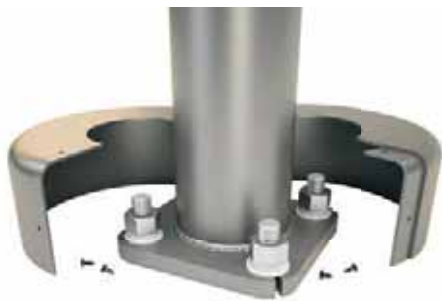

Round ABS plastic base covers are standard in all 11 Gauge VRSS poles that are specified in the following powder coat finishes: BA-Black, BM-Dark Bronze, and BH-White. For 7 Gauge poles and all other colors please see Square Metal base cover note below.



Square Metal powder coated base covers are standard in all 11 Gauge VRSS poles that are specified in colors other than BA-Black, BM-Dark Bronze, and BH-White AND in all 7 Gauge poles in ALL COLORS. Custom specification of VRSS Square Metal style base covers in BA, BM and BH powder coated finishes is available.

EPA Notes:

Effective Projected Area (EPA) in square feet. EPA's calculated using wind velocity (mph) indicated in accordance with 2009 AASHTO LTS-5 using a 25 year design life. Maximum EPA is based on the luminaire weight shown. Increased luminaire weight may reduce the maximum EPA. If weight is exceeded, or if other design life or code is required, please consult the factory.



ROUND TAPERED POLE OPTIONS

VRTS

Round Tapered Steel Pole No Arm — 4-Bolt Base

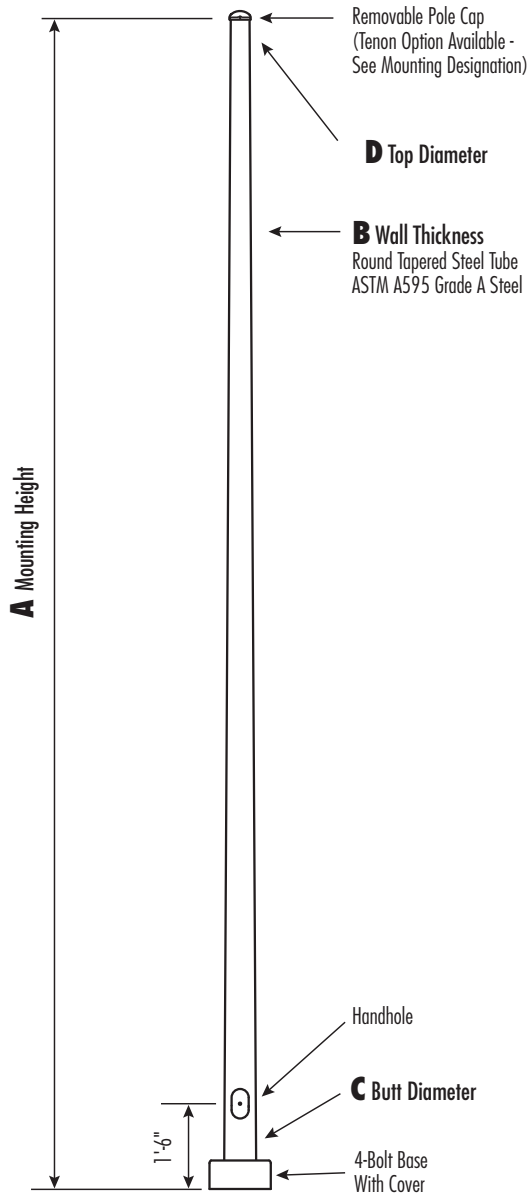

Powder Coated, Galvanized or Powder Coated over Galvanized Finish Per Customer Specification.

C BUTT DIA.	F BOLT CIR. DIA.	G BASE SQ.	H BOLT PROJ.	I BOLT SIZE
4.5	7.5-8.5	8	3.75	.75 x 17 x 3
5.2	8 - 9	8.5	3.75	.75 x 17 x 3
6.1 - 6.6	9.5 - 10.5	10	3.75	.75 x 30 x 3
6.8	10 - 11	10	3.75	.75 x 30 x 3
7.0* - 7.5	10.5 - 11.5	10.5	4.875	1 x 36 x 4
8.0 - 8.1	11 - 12	11	4.875	1 x 36 x 4
8.5	11.5-12.5	12	4.875	1 x 36 x 4
9.0 (11 Gauge)	12 - 13	12.375	4.875	1 x 36 x 4
9.0 (7 Gauge)	13 - 14	12.75	5.875	1.25 x 48 x 6
10	13.5 - 14.5	13	4.875	1 x 48 x 4
11	15 - 16	14	5.875	1.25 x 48 x 6
12	16 - 17	15.5	6.75	1.5 x 54 x 6

*Nominal

WARNING: Do not install light pole without luminaire.

Dimensions in Inches

Pole

Pole shaft shall be weldable-grade, hot-rolled, commercial quality carbon steel tubing conforming to ASTM A595 Grade A. Options include 11 gauge and 7 gauge. All Welds shall conform to AWS D1.2 using ER70S-6 electrodes.

Base Style

4-Bolt Steel Base Plate of fabricated hot rolled carbon steel conforming to ASTM A36 or equivalent (36 ksi minimum yield) with 2-piece Base Cover and attaching hardware. Base Cover will be fabricated from metal materials.



Handhole

Up To 5.9" Butt Diameters - Reinforced, 3" x 5" Handhole with Cover, Stainless Steel Screw and Back Bar. A Grounding Provision incorporating a tapped 1/2"-13NC hole will be welded to the handhole frame.
6+ Butt Diameters - Reinforced, 4" x 6-1/2" Handhole with Cover, Stainless Steel Screw and Back Bar. A Grounding Provision incorporating a tapped 1/2"-13NC hole will be welded to the handhole frame.



Anchorage

Anchorage Kit will include four (4) L-shaped Steel Anchor Bolts conforming to AASHTO M314-90 Grade 55. Ten inches (10") of threaded end will be galvanized per ASTM A153. Kits will contain eight (8) Hex Nuts, four (4) Lock Washers, and eight (8) Flat Washers (all components Galvanized Steel). A bolt circle template will be provided.

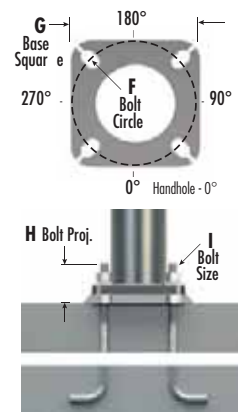

Vibration Damper

If determined necessary by pole manufacturer an internal, factory installed, Second Mode Vibration Damper will be provided. Customer specification of the damper is available.

Mounting Designation

Side Drill Mount

For Side Drill Mount applications specify luminaire type, quantity and orientation. A luminaire drilling template must be supplied at time of order.

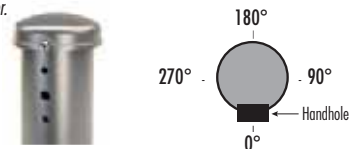

Tenon Mount

For Tenon Mount applications specify both Tenon diameter (2.375", 2.875", 3.5", 4", etc.) and length (3", 4", 5", 6", etc.).



ROUND TAPERED POLE OPTIONS

A MTG. HGT.	B WALL GAUGE	C BUTT DIA.	D TOP DIA.	MAX. TOTAL LUMINAIRE WEIGHT (lbs)	MAXIMUM EPA					CATALOG NUMBER	ANCHOR BOLT KIT PART NUMBER	
					90	100	110	120	130			140
10	11	4.5	3.1	370	31.8	25.5	23.7	19.7	16.6	14.1	VRTS10B45-4**	BT82352
14	11	5.2	3.1	365	31	24.7	22.9	18.9	15.8	13.4	VRTS14B52-4**	BT82352
20	11	6.1	3.3	340	25.9	20.4	18.8	15.4	12.8	10.8	VRTS20B61-4**	BT82353
20	11	6.6	3.7	385	25.5	20	18.5	15.2	12.6	10.7	VRTS20B66-4**	BT82351
25	11	6.1	2.6	280	19	14.7	13.5	10.9	8.8	7.3	VRTS25B61-4**	BT82353
25	11	6.8	3.3	325	19.4	15	13.8	11.1	9.1	7.5	VRTS25B68-4**	BT82353
25	11	7.0	3.3	325	25.9	20.3	18.7	15.2	12.6	10.6	VRTS25B70-4**	BT82351
30	11	6.8	2.6	275	14.7	11.1	10.1	7.9	6.2	5	VRTS30B68-4**	BT82353
30	11	7.0	2.6	275	19.4	15	13.8	11	8.9	7.3	VRTS30B70-4**	BT82351
30	11	7.5	3.3	315	24.5	19	17.5	14.2	11.7	9.7	VRTS30B75-4**	BT82351
30	11	8.0	3.8	345	28.5	22.3	20.6	16.8	14	11.8	VRTS30B80-4**	BT82351
30	11	8.5	4.3	375	32.3	25.5	23.6	19.5	16.3	13.9	VRTS30B85-4**	BT82351
30	11	9.0	4.8	405	35.9	28.5	26.5	21.9	18.4	15.7	VRTS30B90-4**	BT39196
30	7	9.0	4.8	590	58.3	46.7	43.5	36.2	30.6	26.2	VRTS30D90-4**	BT39196
35	11	7.5	2.6	265	18.6	14.4	13.2	10.5	8.4	6.8	VRTS35B75-4**	BT82351
35	11	8.1	3.2	300	22.8	17.6	16.2	12.9	10.5	8.7	VRTS35B81-4**	BT82351
35	11	8.5	3.6	320	25.2	19.5	18	14.5	11.9	10	VRTS35B85-4**	BT82351
35	11	9.0	4.1	345	28.1	21.9	20.3	16.6	13.8	11.6	VRTS35B90-4**	BT39196
35	7	9.1	4.1	490	46.6	36.9	34.3	28.3	23.8	20.3	VRTS35D90-4**	BT39196
39	11	8.1	2.6	265	18.3	14.1	12.9	10.3	8.2	6.6	VRTS39B81-4**	BT82351
39	11	9.0	3.5	305	23.3	18	16.5	13.2	10.8	8.9	VRTS39B90-4**	BT39196
39	7	9.0	3.5	425	38.6	30.5	28.2	23.2	19.4	16.4	VRTS39D90-4**	BT39196
39	11	10.0	4.5	350	26.8	20.9	19.3	15.8	13.1	11	VRTS39B10-4**	BT272-001
39	7	11.0	5.5	600	53.7	43	40	33.2	27.9	23.6	VRTS39D11-4**	BT39196

2-Piece Shaft Design

A MTG. HGT.	B WALL GAUGE	C BUTT DIA.	D TOP DIA.	MAX. TOTAL LUMINAIRE WEIGHT (lbs)	MAXIMUM EPA					CATALOG NUMBER	ANCHOR BOLT KIT PART NUMBER	
					90	100	110	120	130			140
45	7	11	4.8	150	42.8	33.8	31.4	25.9	21.6	18.2	VRTS45D11-4**	BT39196
50	7	11	4.1	150	32.1	26.3	24.9	20.9	17.2	14.4	VRTS50D11-4**	BT39196

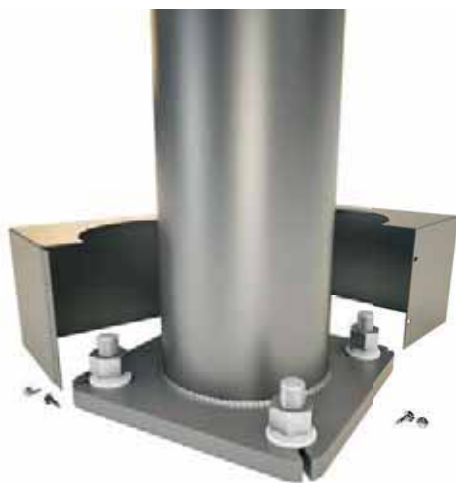

Square Metal powder coated base covers are standard in all VRTS poles.

Catalog Number System

The catalog number for Venture Lighting poles utilizes the following identification system.

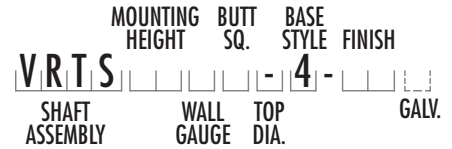

Catalog Number Example -

VRTS 30 B 80 - 4 - BM

Round Tapered Steel, 30' Mounting Height, 11 Gauge, 8.0" Butt Diameter, Tapered, 4-Bolt Base, Dark Bronze Powder Coat Finish.

Wall Gauge

B = 11 Gauge
D = 7 Gauge

Butt Diameter

45 = 4.5"
52 = 5.2"
61 = 6.1"
66 = 6.6"
68 = 6.8"
70 (Nominal) = 6.8"
75 = 7.5"
80 = 8.0"
81 = 8.1"
8.5 = 8.5"
9.0 = 9.0"
10 = 10"
11 = 11"
12 = 12"

Top Diameter

- = Varies (See Table)

Base Style

4 = 4-Bolt Anchor Base

Finish

BA = Black Powder Coat
BH = White Powder Coat
BM = Dark Bronze Powder Coat
BV = Dark Green Powder Coat
GC = Gray Powder Coat
** = Specify Finish
00 = Galvanized Only (No Powder Coat)

Galvanization

G = Galvanized

Code "G" to be used only if pole is to be specified "Powder Paint Over Galvanized" or "Galvanized Only".

EPA Notes:

Effective Projected Area (EPA) in square feet. EPA's calculated using wind velocity (mph) indicated in accordance with 2009 AASHTO LTS-5 using a 25 year design life. Maximum EPA is based on the luminaire weight shown. Increased luminaire weight may reduce the maximum EPA. If weight is exceeded, or if other design life or code is required, please consult the factory.



VIBRATION DAMPENERS

Wind Induced Vibration

There are two common types of wind-induced vibration observed in poles: First Mode Vibration and Second Mode Vibration (See illustrations to the left).

First Mode Vibration (PA56127)

In first mode vibration, sometimes referred to as sway, the maximum deflection occurs at the top of the pole. First mode oscillation typically occurs at a low frequency of approximately one cycle per second. Normal deflection of this shape usually is not harmful to the pole or luminaire, but first mode oscillating vibration will cause damage and failure.

Second Mode Vibration (PA56128)

Second mode vibration can be the most damaging form of vibration. It occurs approximately at the midpoint of the pole with the deflection off center equal from side-to-side. It occurs at a higher frequency, typically three to six cycles per second. Second mode vibration occurs when the wind synchronizes with the pole's natural frequency of vibration. This is known as resonance. As the steady low level wind moves past the pole, vortices are shed alternately from either side of the structural shaft causing displacement oscillations in a direction perpendicular to that of the wind. Vortices are a swirling motion or pattern of the wind. The most serious situation arises when the vortex-shedding frequency synchronizes with the natural period of vibration in the pole, which can ultimately fatigue the pole to structural failure.

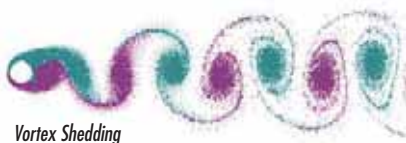

Vortex Shedding

Wind induced vibration can be caused by steady, relatively low-speed wind (10-30 mph), by topography and by the structure to which the pole is mounted or nearby structures. Destructive vibration is not an indication of substandard material, workmanship or design of pole.

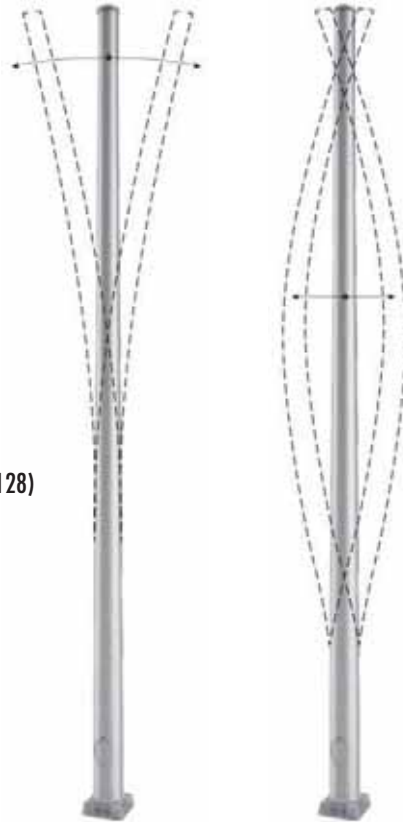

First Mode Vibration

Second Mode Vibration

Vibration Dampers

Venture Lighting is proud to offer industry-leading steel poles to coordinate with our area lighting LED luminaires. Venture Lighting has partnered with an industry leader in pole design and manufacturing. Our partner's decades of research and testing has led to the knowledge and background to assure that customers receive the safest, longest lasting pole designs.

To minimize the effects of first or second mode vibration, manufacturers have developed dampers which very effectively quell wind induced vibration of lighting poles.

Free Vibration Test Curves



Free Vibration Test of Pole with No Added Dampening



Free Vibration Test of Pole with Impact Damper

Department of Energy Wind Map

Locations with high average wind speeds are more prone to pole vibration problems than locations with high maximum wind speeds. Areas of high average wind speeds can be identified on the U.S. Department of Energy Residential Scale 30 Meter Wind Map which can be accessed at the U.S. Department of Energy website.

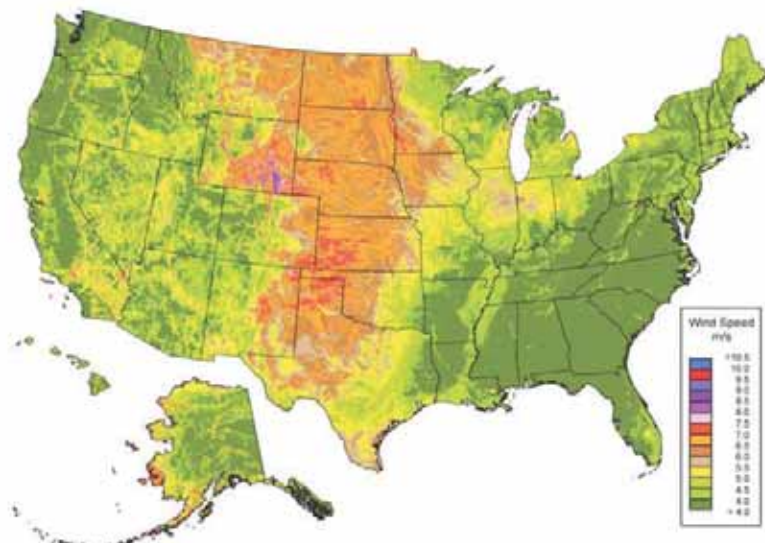

The average wind speeds indicated on this map are model-derived estimates that may not represent the true wind resource at any given location. Small terrain features, vegetation, buildings and atmospheric effects may cause the wind speed to depart from the map estimates. Expert advice should be sought in placing wind turbines and estimating their energy production.

Source: Wind resource estimates developed by AWS Truepower, LLC. Map developed by NREL. Spatial resolution of wind resource data: 2.0 km. Projection: Albers Equal Area WGS84.



VIBRATION DAMPENERS, GFI OPTIONS, WIND MAP

1st Mode Vibration Dampeners (PA56127)

Venture Lighting's pole partner's patented First Mode Vibration Damper is field installed at the top of square poles. This damper very effectively reduces first mode vibration of square lighting poles. Due to potential vibration fatigue issues that can be associated with moderate wind conditions, **First Mode Dampers are recommended for square poles with mounting heights greater than 25' and for square poles with light loading fixtures less than 2.0 EPA.**

First Mode Vibration Damper



First Mode Vibration Damper



First Mode Vibration

2nd Mode Vibration Dampeners (PA56128)

The Venture Lighting's Pole Partner's Second Mode Damper was awarded the industry's first patent in the vibration damping category in 1972.

The Second Mode Damper is attached to the pole at approximately the midpoint of the pole, and can be factory bolted inside the pole or field mounted on the inside or outside of an existing pole. Based on past experience, some Venture Lighting poles include factory-installed Second Mode Vibration Dampers as a standard component. **If the poles you intend to order are to be bridge mounted, used as camera poles, or may be subject to unusual site conditions, wide open terrain, steady or high energy prevailing winds, or other site conditions as mentioned, please make Venture Lighting aware of these conditions. Or, if your installed poles are exhibiting oscillation, contact Venture Lighting to pursue a damping solution that may include installing a Venture Lighting Second Mode Damper on the poles.**

Second Mode Vibration Damper



Second Mode Vibration

GFI Options

For customers who would like an option to power holiday decorations, speakers for a street event, or other small equipment used for pole or street maintenance, a 120V GFCI receptacle can be mounted into the pole. The receptacle is a 20 Amp 120V Duplex GFCI and is weather resistant (WR) and UL approved.

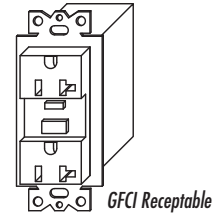

GFCI Receptacle

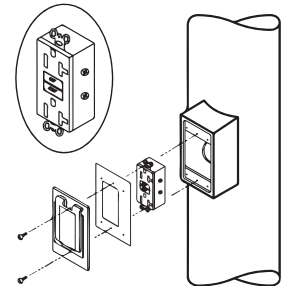

GFCI Receptacle mounted to pole

Wind Map

2009 AASHTO LTS-5 specification 3-second gust basic wind speeds (mph) with gust effect factor (G) of 1.14 and 25 year design life wind map (ASCE 7-05) is shown above. This wind map should be used to determine wind velocity for your specific location. If you are located between two different velocity isotach lines, the higher velocity should be used. Local isolated high wind conditions can be devastating to poles and luminaires not designed for such conditions. Additionally, constant winds in the 10-25 mph range can severely damage certain poles and luminaires by vibration. Follow the guidelines shown in the map.

Wind Speeds - Other Regions

LOCATION	MPH	(M/S)
Hawaii	105	(47)
Puerto Rico	145	(65)
Guam	170	(76)
Virgin Islands	145	(65)
American Samoa	125	(56)
Alaska	90-130	(40-58)

- 85 MPH
- 90 MPH
- 100 MPH
- 110 MPH
- 120 MPH
- 130 MPH
- 140 MPH
- 150 MPH
- Special Wind Region

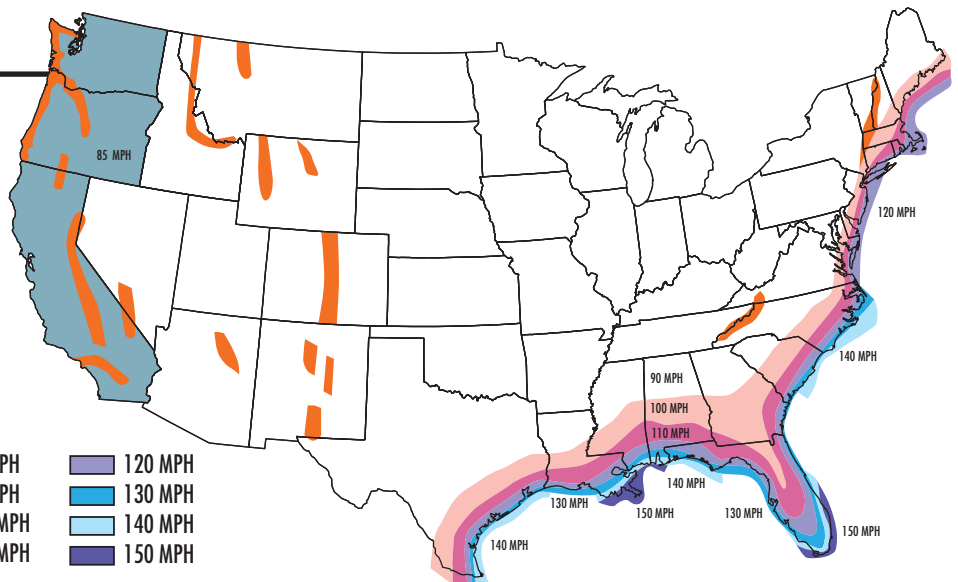

ACCESSORIES FOR POLE OPTIONS

Spokes

Designed to mount on a 2 3/8" dia. pole top tenon - All spoke tenon diameters are 2 3/8"



Description: Single Spoke Arm
Order Code: SP1H6BZ
Color: Bronze
Weight: 6 lbs
EPA: 0.3 ft²

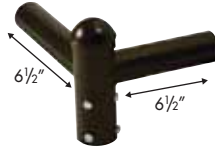

Description: Twin Spoke Accessory with 90° Arms
Order Code: SP2H906BZ
Color: Bronze
Weight: 9 lbs
EPA: 0.4 ft²

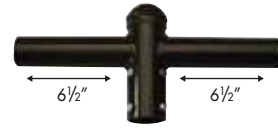

Description: Twin Spoke Accessory with 180° Arms
Order Code: SP2H1806BZ
Color: Bronze
Weight: 9 lbs
EPA: 0.4 ft²

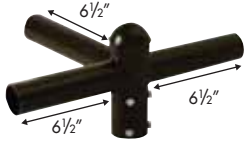

Description: Triple Spoke Accessory with 90° Arms
Order Code: SP3H906BZ
Color: Bronze
Weight: 11 lbs
EPA: 0.5 ft²

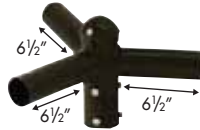

Description: Triple Spoke Accessory with 120° Arms
Order Code: SP3H1206BZ
Color: Bronze
Weight: 11 lbs
EPA: 0.5 ft²

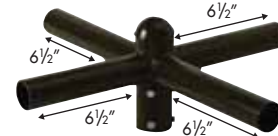

Description: Quad Spoke Accessory with 90° Arms
Order Code: SP4H906BZ
Color: Bronze
Weight: 13 lbs
EPA: 0.6 ft²

Bullhorns

Designed to mount on a 2 3/8" dia. pole top tenon - All bullhorn tenon diameters are 2 3/8"

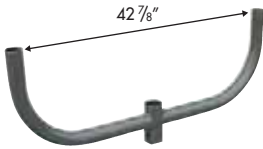

Description: Double Bullhorn with 180° Arms
Order Code: BH2V180BZ
Color: Bronze
Weight: 17 lbs.
EPA: 0.9 ft²

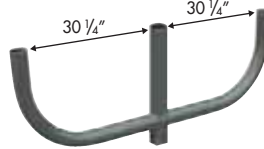

Description: Triple Bullhorn with 180° Arms
Order Code: BH3V180BZ
Color: Bronze
Weight: 27 lbs.
EPA: 1.5 ft²

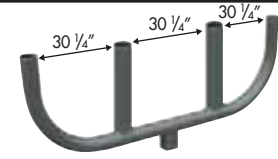

Description: Quad Bullhorn with 180° Arms
Order Code: BH4V180BZ
Color: Bronze
Weight: 38 lbs.
EPA: 2.2 ft²

Cross Arms

for 4" Straight Square Poles - Designed to mount on a 2 3/8" dia. pole top tenon - All cross arm tenons are 4" tall with 2 3/8" diameter

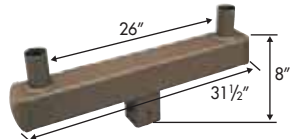

Description: Cross arm for 4" Square Pole with Twin 180° Vertical Tenons
Order Code: CA42V180BZ
Color: Bronze
Weight: 25 lbs.
EPA: 1 ft²

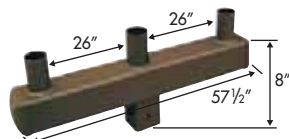

Description: Cross arm for 4" Square Pole with Triple 180° Vertical Tenons
Order Code: CA43V180BZ
Color: Bronze
Weight: 40 lbs.
EPA: 1.9 ft²

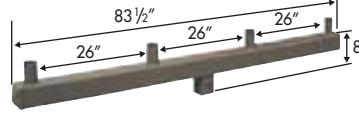

Description: Cross arm for 4" Square Pole with Quad 180° Vertical Tenons
Order Code: CA44V180BZ
Color: Bronze
Weight: 56 lbs.
EPA: 2.7 ft²

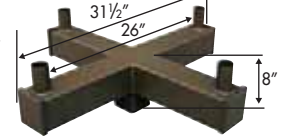

Description: Cross arm for 4" Square Pole with Quad 90° Vertical Tenons
Order Code: CA44V90BZ
Color: Bronze
Weight: 44 lbs.
EPA: 1.1 ft²

Cross Arms

for 5" Straight Square Poles - Designed to mount on a 2 3/8" dia. pole top tenon - All cross arm tenons are 4" tall with 2 3/8" diameter

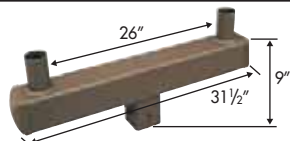

Description: Cross arm for 5" Square Pole with Twin 180° Vertical Tenons
Order Code: CA52V180BZ
Color: Bronze
Weight: 29.25 lbs.
EPA: 1 ft²

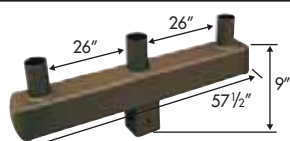

Description: Cross arm for 5" Square Pole with Triple 180° Vertical Tenons
Order Code: CA53V180BZ
Color: Bronze
Weight: 46 lbs.
EPA: 1.9 ft²

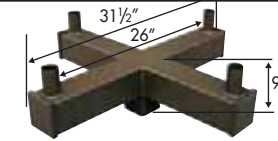

Description: Cross arm for 5" Square Pole with Quad 90° Vertical Tenons
Order Code: CA54V90BZ
Color: Bronze
Weight: 49 lbs.
EPA: 1.1 ft²



ACCESSORIES FOR POLE OPTIONS

Wall Mounting Brackets

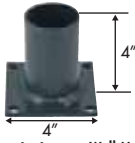

Description: Wall Mount Bracket
Order Code: WM1H4BZ
Color: Bronze
Weight: 2 lbs.
EPA: 0.1 ft²
Tenon Dia.: 2 3/8"

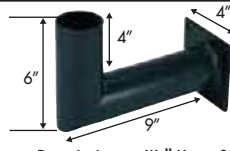

Description: Wall Mount 90° Bracket
Order Code: WM1V906BZ
Color: Bronze
Weight: 4.5 lbs.
EPA: 0.3 ft²
Tenon Dia.: 2 3/8"

Single Pole Top Fitters Straight Square Poles

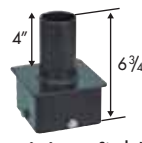

Description: Single Vertical Tenon for 4" Square Pole
Order Code: TN4SQ1V4BZ
Color: Bronze
Weight: 4 lbs.
EPA: 0.1 ft²
Tenon Dia.: 2 3/8"

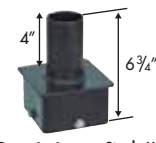

Description: Single Vertical Tenon for 5" Square Pole
Order Code: TN5SQ1V4BZ
Color: Bronze
Weight: 5 lbs.
EPA: 0.1 ft²
Tenon Dia.: 2 3/8"

Pole Top Fitters Designed to mount on top of a 4" straight square pole - Tenon diameters are 2 3/8"

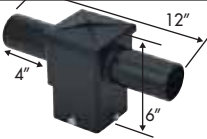

Description: 180° Twin Horizontal Tenon for 4" Square Pole
Order Code: TN4SQ2H1804BZ
Color: Bronze
Weight: 7.5 lbs.
EPA: 0.2 ft²



Description: 90° Twin Horizontal Tenon for 4" Square Pole
Order Code: TN4SQ2H904BZ
Color: Bronze
Weight: 7.5 lbs.
EPA: 0.2 ft²

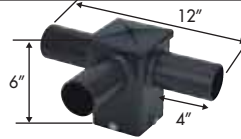

Description: 90° Triple Horizontal Tenon for 4" Square Pole
Order Code: TN4SQ3H904BZ
Color: Bronze
Weight: 8.5 lbs.
EPA: 0.2 ft²



Description: 90° Quad Horizontal Tenon for 4" Square Pole
Order Code: TN4SQ4H904BZ
Color: Bronze
Weight: 9.75 lbs.
EPA: 0.2 ft²

Pole Top Fitters Designed to mount on top of a 5" straight square pole - Tenon Diameters are 2 3/8"



Description: 180° Twin Horizontal Tenon for 5" Square Pole
Order Code: TN5SQ2H1804BZ
Color: Bronze
Weight: 8.5 lbs.
EPA: 0.2 ft²
Tenon Dia.: 2 3/8"



Description: 90° Twin Horizontal Tenon for 5" Square Pole
Order Code: TN5SQ2H904BZ
Color: Bronze
Weight: 9.25 lbs.
EPA: 0.2 ft²
Tenon Dia.: 2 3/8"

Pole Top Fitters for 4" Straight Round Poles

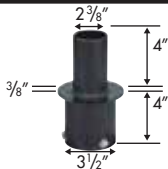

Description: Single 2-3/8" Dia. Vertical Tenon for 4" Round Pole
Order Code: TN4RD1V4238BA
Color: Black
Weight: 1.25 lbs.
EPA: 0.1 ft²



Description: Single 2-7/8" Dia. Vertical Tenon for 4" Round Pole
Order Code: TN4RD1V4278BA
Color: Black
Weight: 1.5 lbs.
EPA: 0.1 ft²

Pole Top Fitters for 5" Straight Round Poles



Description: Single 2-3/8" Dia. Vertical Tenon for 5" Round Pole
Order Code: TN5RD1V4238BA
Color: Black
Weight: 2.25 lbs.
EPA: 0.1 ft²

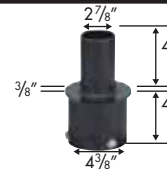

Description: Single 2-7/8" Dia. Vertical Tenon for 5" Round Pole
Order Code: TN5RD1V4278BA
Color: Black
Weight: 2.25 lbs.
EPA: 0.1 ft²



HIGH INTENSITY DISCHARGE LIGHTING SOLUTIONS



Super Pulse Start Long Life (SPL) Lamps



HID METAL HALIDE LAMPS



Pulse Start and Probe Start Lamps

Open Rated *Pulse Start* Lamps

Watts	Order Code	Product Description	Bulb	Base	Bulb Finish	Operating Position	CCT	ANSI Code	Case Pack
50	32100	MP 50W/U/PS	EDX17	Medium (E26)	Clear	Universal	4000K	M110/O	12
70	40389	MP 70W/U/PS	EDX17	Medium (E26)	Clear	Universal	4000K	M98/O	12
100	96770	MP 100W/U/PS/3K	EDX17	Medium (E26)	Clear	Universal	3200K	M90/O	12
	96267	MP 100W/U/PS	EDX17	Medium (E26)	Clear	Universal	4000K	M90/O	12
	22145	MP 100W/C/U/ED28/PS/3K	ED28	Mogul (EX39)	Coated	Universal	3200K	M90/O	12
125	25813	MP 125W/V/ED28/PS	ED28	Mogul (EX39)	Clear	V±15°	4000K	M150/O	12
150	22455	MP 150W/U/PS/740	EDX17	Medium (E26)	Clear	Universal	4000K	M102/O	12
	58963	MP 150W/U/ED28/PS/740	ED28	Mogul (EX39)	Clear	Universal	4000K	M102/O	12
175	31928	MP 175W/C/U/PS/737	ED28	Mogul (EX39)	Coated	Universal	3700K	M152/O	12
	18717	MP 175W/U/PS/740	ED28	Mogul (EX39)	Clear	Universal	4000K	M152/O	12
200	44872	MP 200W/C/V/PS/732	ED28	Mogul (EX39)	Coated	V±15°	3200K	M136/O	12
	22147	MP 200W/V/PS/740	ED28	Mogul (EX39)	Clear	V±15°	4000K	M136/O	12
250	25029	MP 250W/C/U/PS/737	ED28	Mogul (EX39)	Coated	Universal	3700K	M153/O	12
	25028	MP 250W/U/PS/740	ED28	Mogul (EX39)	Clear	Universal	4000K	M153/O	12
320	32029	MP 320W/C/U/ED28/PS/737	ED28	Mogul (EX39)	Coated	Universal	3700K	M154/O	12
	32028	MP 320W/U/ED28/PS/740	ED28	Mogul (EX39)	Clear	Universal	4000K	M154/O	12
	32039	MP 320W/C/U/ED37/PS/737	ED37	Mogul (EX39)	Coated	Universal	3700K	M154/O	6
	32037	MP 320W/U/ED37/PS/740	ED37	Mogul (EX39)	Clear	Universal	4000K	M154/O	6
350	51208	MP 350W/H75/T15/L/PS/740	T15	Mogul (EX39)	Clear	HOR±75°	4000K	M131/O	12
350/	18692	MP 350W/400W/U/ED28/PS/740	ED28	Mogul (EX39)	Clear	Universal	4000K	M131/O, M155/O	12
400	51352	MP 350W/400W/C/U/PS/737	ED37	Mogul (EX39)	Coated	Universal	3700K	M131/O, M155/O	6
	23589	MP 350W/400W/U/PS/740	ED37	Mogul (EX39)	Clear	Universal	4000K	M131/O, M155/O	6
400	73189	MP 400W/H75/T15/L/PS/740	T15	Mogul (EX39)	Clear	HOR±75°	4000K	M155/O	12
	45541*	MP 400W/C/V/PS/737	ED37	Mogul (EX39)	Coated	V±15°	3700K	M155/O	6
450	65072	MP 450W/BU/PS/740	ED37	Mogul (EX39)	Clear	BU±15°	4000K	M144/O	6
575	37292	MP 575W/U/BT37/PS/740	BT37	Mogul (EX39)	Clear	Universal	4000K	M178/O	6
875	58953	MP 875W/BU/BT37/PS/740	BT37	Mogul (EX39)	Clear	BU±15°	4000K	M166/O	6

Open Rated *Probe Start* Lamps

Watts	Order Code	Product Description	Bulb	Base	Bulb Finish	Operating Position	CCT	ANSI Code	Case Pack
250	27564	MPI 250W/U	ED28	Mogul (EX39)	Clear	Universal	4000K	M58/O	12
400	28715	MPI 400W/U	ED37	Mogul (EX39)	Clear	Universal	4000K	M59/O	6
1000	62948	MPI 1000W/BU	BT56	Mogul (EX39)	Clear	BU±15°	3500K	M47/O	6

NOTE: * Available while supplies last



HID METAL HALIDE LAMPS



Pulse Start and Probe Start Lamps

Enclosed Rated *Pulse Start* Lamps

Watts	Order Code	Product Description	Bulb	Base	Bulb Finish	Operating Position	CCT	ANSI Code	Case Pack
50	52312	MH 50W/U/PS	ED17	Medium (E26)	Clear	Universal	4000K	M110/E	12
70	78138	MH 70W/U/PS	ED17	Medium (E26)	Clear	Universal	4000K	M98/E	12
	16017	MH 70W/U/ED28/PS	ED28	Mogul (E39)	Clear	Universal	4000K	M98/E	12
100	27266	MH 100W/U/PS	ED17	Medium (E26)	Clear	Universal	4000K	M90/E	12
	67868	MH 100W/U/ED28/PS	ED28	Mogul (E39)	Clear	Universal	4000K	M90/E	12
150	99584	MH 150W/U/PS/740	ED17	Medium (E26)	Clear	Universal	4000K	M102/E	12
	75418	MH 150W/U/ED23.5/PS/740	ED23.5	Mogul (E39)	Clear	Universal	4000K	M102/E	12
	13556	MH 150W/U/ED28/PS/740	ED28	Mogul (E39)	Clear	Universal	4000K	M102/E	12
175	16497	MS 175W/BU/MED/PS/740	ED17	Medium (E26)	Clear	BU±15°	4000K	M152/E	12
	29145	MH 175W/U/PS/740	ED28	Mogul (E39)	Clear	Universal	4000K	M152/E	12
200	60811	MS 200W/BU/MED/PS/740	ED17	Medium (E26)	Clear	BU±15°	4000K	M136/E	12
250	57625	MS 250W/H75/T15/PS/740	T15	Mogul (E39)	Clear	HOR±75°	4000K	M153/E	12
	37517	MH 250W/U/PS/740	ED28	Mogul (E39)	Clear	Universal	4000K	M153/E	12
320	57626	MS 320W/H75/T15/S/PS/740	T15	Mogul (E39)	Clear	HOR±75°	4000K	M154/E	12
	79710	MS 320W/H75/T15/L/PS/740	T15	Mogul (E39)	Clear	HOR±75°	4000K	M154/E	12
	12718*	MH 320W/U/ED28/PS/740	ED28	Mogul (E39)	Clear	Universal	4000K	M154/E	12
	21785	MH 320W/U/ED37/PS/740	ED37	Mogul (E39)	Clear	Universal	4000K	M154/E	6
350	60258	MS 350W/H75/T15/S/PS/740	T15	Mogul (E39)	Clear	HOR±75°	4000K	M131/E	12
	93749	MS 350W/H75/T15/L/PS/740	T15	Mogul (E39)	Clear	HOR±75°	4000K	M131/E	12
350/ 400	50268	MH 350W/400W/U/ED28/PS/740	ED28	Mogul (E39)	Clear	Universal	4000K	M131/E, M155/E	12
	26189	MH 350W/400W/U/PS/740	ED37	Mogul (E39)	Clear	Universal	4000K	M131/E, M155/E	6
400	60260	MS 400W/H75/T15/S/PS/740	T15	Mogul (E39)	Clear	HOR±75°	4000K	M155/E	12
	47815*	MH 400W/C/U/ED28/PS/737	ED28	Mogul (E39)	Coated	Universal	3700K	M155/E	12
875	90195	MH 875W/U/BT37/PS/740	BT37	Mogul (E39)	Clear	Universal	4000K	M166/E	6
1000	49111	MS 1000W/HOR/T25/PS/734	T25	Mogul POMB (EP39)	Clear	HOR±45°	3400K	M141/E	6
	37999	MH 1000W/U/BT37/PS/740	BT37	Mogul (E39)	Clear	Universal	4000K	M141/E	6
	71722*	MS 1000W/BU/BT37/PS/740	BT37	Mogul (E39)	Clear	BU±15°	4000K	M141/E	6
	56999	MH 1000W/U/PS/740	BT56	Mogul (E39)	Clear	Universal	4000K	M141/E	6

Enclosed Rated *Probe Start* Lamps

Watts	Order Code	Product Description	Bulb	Base	Bulb Finish	Operating Position	CCT	ANSI Code	Case Pack
175	63187	MH 175W/C/U/MED	ED17	Medium (E26)	Coated	Universal	3700K	M57/E	12
	15556	MH 175W/U/MED	ED17	Medium (E26)	Clear	Universal	4000K	M57/E	12
	96627	MH 175W/C/U	ED28	Mogul (E39)	Coated	Universal	3700K	M57/E	12
	88791	MH 175W/U	ED28	Mogul (E39)	Clear	Universal	4000K	M57/E	12
250	33479	MH 250W/U/T15	T15	Mogul (E39)	Clear	Universal	4000K	M58/E	12
	63052	MH 250W/U	ED28	Mogul (E39)	Clear	Universal	4000K	M58/E	12
400	55422	MH 400W/U/T15	T15	Mogul (E39)	Clear	Universal	4000K	M59/E	12
	57540	MH 400W/U/ED28	ED28	Mogul (E39)	Clear	Universal	4000K	M59/E	12
	83545	MH 400W/C/U	ED37	Mogul (E39)	Coated	Universal	3700K	M59/E	6
	18520	MH 400W/U	ED37	Mogul (E39)	Clear	Universal	4000K	M59/E	6
	64648	MS 400W/C/HOR	ED37	Mogul POMB (EP39)	Coated	HOR±45°	3700K	M59/E	6
1000	15332	MH 1000W/U/BT37	BT37	Mogul (E39)	Clear	Universal	4000K	M47/E	6
	72051	MH 1000W/U	BT56	Mogul (E39)	Clear	Universal	4000K	M47/E	6

NOTE: * Available while supplies last



HID SPECIALIZED METAL HALIDE



Super Pulse Start Long Life (SPL) Lamps

Enclosed Rated SPL Lamps

Watts	Order Code	Product Description	Bulb	Base	Bulb Finish	Operating Position	CCT	ANSI Code	Case Pack
100	21982	MHL 100W/U/ED17/PS/740	ED17	Medium (E26)	Clear	Universal	4000K	M90/E	12
150	46105	MHL 150W/U/ED28/PS/740	ED28	Mogul (E39)	Clear	Universal	4000K	M102/E	12
200	98434	MHL 200W/V/ED28/PS/740	ED28	Mogul (E39)	Clear	V±15°	4000K	M136/E	12
250	46895	MHL 250W/V/ED28/PS/740	ED28	Mogul (E39)	Clear	V±15°	4000K	M153/E	12
	65413	MHL 250W/H75/ED28/PS/740	ED28	Mogul (E39)	Clear	HOR±75°	4000K	M153/E	12
320	20116	MHL 320W/H75/ED28/PS/740	ED28	Mogul (E39)	Clear	HOR±75°	4000K	M154/E	12
575	68735	MHL 575W/BU/BT37/PS/740	BT37	Mogul (E39)	Clear	BU±15°	4000K	M178/E	6
	20897	MHL 575W/H75/BT37/PS/740	BT37	Mogul (E39)	Clear	HOR±75°	4000K	M178/E	6

Benefits and Features

- 40,000 hours rated life; up to twice the life of most regular Metal Halide products
- Quartz metal halide
- Excellent maintained lumens with up to 114 LPW
- Ultimate retrofit solution
- Cuts maintenance costs nearly in half, while doubling life and lumen maintenance



Sports Lighting Lamps

Enclosed Rated Sports Lighting Lamps

Watts	Order Code	Product Description	Bulb	Base	Bulb Finish	Operating Position	CCT	ANSI Code	Case Pack
1000	47503	MS 1000W/HOR/SPORT60	BT56	Mogul POMB (EP39)	Clear	HOR±60°	3400K	M47/E	6
1500	12342	MH 1500W/U/XL	BT56	Mogul (E39)	Clear	Universal	4000K	M48/E	6
	18360	MH 1500W/HBU	BT56	Mogul (E39)	Clear	BU±105°	3400K	M48/E	6
	82070	MS 1500W/HOR/XP/SPORT60	BT56	Mogul POMB (EP39)	Clear	HOR±60°	3400K	M48/E	6
1650	16419	MS 1650W/HOR/XP/SPORT60	BT56	Mogul POMB (EP39)	Clear	HOR±60°	3200K	M112/E	6

Benefits and Features

- Brighter - High lumen output
- "Extra Life" lamp available - Venture's MH 1500W/U/XL lamp has a 6000 hour rated life
- Venture's Sports 60 lamps are designed for sports lighting aiming angles
- High lumen output lamps for efficient layout designs
- Good color rendition (65-70 CRI)



Energy Master Energy Saving Retrofit Lamps

Open Rated Energy Master Lamps ANSI Code M59/O and M155/O

Watts	Order Code	Product Description	Bulb	Base	Bulb Finish	Operating Position	CCT	Replaces Existing Wattage	Watts Saved	Case Pack
330	91844	MPI 330W/C/BU/EM	ED37	Mogul (EX39)	Coated	BU±15°	3700K	400W	70	6
	91834	MPI 330W/BU/EM	ED37	Mogul (EX39)	Clear	BU±15°	4000K	400W	70	6

Open Rated Energy Master Lamps ANSI Code M59/O and M165/O

Watts	Order Code	Product Description	Bulb	Base	Bulb Finish	Operating Position	CCT	Replaces Existing Wattage	Watts Saved	Case Pack
360	67293	MPI 360W/C/BU/EM	BT37	Mogul (EX39)	Coated	BU±15°	3700K	400W	40	6
	38029	MPI 360W/BU/EM	BT37	Mogul (EX39)	Clear	BU±15°	4000K	400W	40	6

Enclosed Rated Energy Master Lamps ANSI Code M57/E and M107/E

Watts	Order Code	Product Description	Bulb	Base	Bulb Finish	Operating Position	CCT	Replaces Existing Wattage	Watts Saved	Case Pack
150	44810	MH 150W/U/EM	ED17	Medium (E26)	Clear	Universal	4000K	175W	25	12
	69559	MH 150W/U/ED28/EM	ED28	Mogul (E39)	Clear	Universal	4000K	175W	25	12

Benefits and Features

- Just change the lamp not the ballast
- Save energy; Up to \$25.50 annually per lamp
- Open rated lamps available in 330W and 360W



HID SPECIALIZED METAL HALIDE



Natural White® PS MH, 5000K, 90+ CRI

Open Rated *Natural White*® Lamps

Watts	Order Code	Product Description	Bulb	Base	Bulb Finish	Operating Position	CCT	ANSI Code	Case Pack
250	19523	MP 250W/BU/PS/EM/950	ED28	Mogul (EX39)	Clear	BU±15°	5000K	M153/O	12
320	95320	MP 320W/H75/T15/S/PS/EM/950	T15	Mogul (EX39)	Clear	HOR±75°	5000K	M154/O	12
	95321	MP 320W/H75/T15/L/PS/EM/950	T15	Mogul (EX39)	Clear	HOR±75°	5000K	M154/O	12
350	51628	MP 350W/BU/PS/EM/950	ED37	Mogul (EX39)	Clear	BU±15°	5000K	M131/O	6
400	57129	MP 400W/BU/PS/EM/950	ED37	Mogul (EX39)	Clear	BU±15°	5000K	M155/O	6
575	95575	MP 575W/BU/BT37/PS/EM/950	BT37	Mogul (EX39)	Clear	BU±15°	5000K	M178/O	6
775	24983	MP 775W/BU/BT37/PS/950	BT37	Mogul (EX39)	Clear	BU±15°	5000K	M181/O	6
	24988	MP 775W/BD/BT37/PS/950	BT37	Mogul (EX39)	Clear	BD±15°	5000K	M181/O	6

Enclosed Rated *Natural White*® Lamps

Watts	Order Code	Product Description	Bulb	Base	Bulb Finish	Operating Position	CCT	ANSI Code	Case Pack
575	95577	MS 575W/H75/BT37/PS/EM/950	BT37	Mogul (E39)	Clear	HOR±75°	5000K	M178/E	6
775	24999	MS 775W/H75/BT37/PS/950	BT37	Mogul (E39)	Clear	HOR±75°	5000K	M181/E	6



White-Lux Metal Halide Retrofit HPS Lamps

Open Rated *White-Lux* Lamps

Watts	Order Code	Product Description	Bulb	Base	Bulb Finish	Operating Position	CCT	ANSI Code	Case Pack
250	24785	MPI 250W/BU/LU	ED28	Mogul (EX39)	Clear	BU±15°	4000K	S50/O	12
400	10044	MPI 400W/BU/LU	ED37	Mogul (EX39)	Clear	BU±15°	4000K	S51/O	6

Enclosed Rated *White-Lux* Lamps

Watts	Order Code	Product Description	Bulb	Base	Bulb Finish	Operating Position	CCT	ANSI Code	Case Pack
250	91051	MH 250W/U/LU	ED28	Mogul (E39)	Clear	Universal	4000K	S50/E	12
400	59441	MH 400W/U/LU/ED28	ED28	Mogul (E39)	Clear	Universal	4000K	S51/E	12
	52134	MH 400W/U/LU	ED37	Mogul (E39)	Clear	Universal	4000K	S51/E	6



Double Ended Metal Halide Lamps

Enclosed Rated *Double Ended* Lamps

Watts	Order Code	Product Description	Bulb	Base	Bulb Finish	Operating Position	CCT	ANSI Code	Case Pack
70	16786	MH-DE 70W/UVS/3K	T6	RSC (R7s)	Clear	HOR±45°	3000K	M85/E	25
	60248	MH-DE 70W/UVS/4K	T6	RSC (R7s)	Clear	HOR±45°	4200K	M85/E	25
150	11295	MH-DE 150W/UVS/3K	T7	RSC (R7s)	Clear	HOR±45°	3000K	M81/E	25
	74756	MH-DE 150W/UVS/4K	T7	RSC (R7s)	Clear	HOR±45°	4200K	M81/E	25
	29963	MH-DE 150W/UVS/FS/6K	T7	RSC (R7s)	Clear	HOR±45°	6500K	M81/E	25
250	84727	MH-DE 250W/UVS/3K/FC2	T8	Fc2	Clear	HOR±45°	3000K	M80/E	25
	72748	MH-DE 250W/UVS/4K/FC2	T8	Fc2	Clear	HOR±45°	4200K	M80/E	25
1000	22417	MBIL S 1000W	T5	RSC (Rx7s)	Frosted	HOR±15°	5200K	M___/F	6
1500	22151	MBIL S 1500W	T7	RSC (Rx7s)	Frosted	HOR±15°	5200K	M133/F	6
	22528	MH-DE 1500W/T8/F	T8	Spade Connector	N/A	HOR±15°	4200K	M133/F	2
2000	22132	MBIL S 2000W	T8	Contact Factory	Frosted	HOR±15°	5200K	M134/F	2

Benefits and Features

- Crisp, bright light with 5000K CCT and 90+ CRI
- 90% maintained lumens (0.90 LLD)
- 14% Perceivable brighter light
- Extreme long life at 26,000 - 40,000 hours

Benefits and Features

- Replace yellow HPS lamps with white MH lamps
- Just change the lamp not the ballast
- Electrical and photometric compatibility with HPS systems
- Clear and coated outer jacket options

Benefits and Features

- Available in 70W - 250W and 1000W - 2000W
- Low wattage lamps have compact configuration which provides excellent optical control in smaller fixture designs
- High wattage lamps are used for large area floodlighting and sports lighting applications



HID HIGH PRESSURE SODIUM LAMPS



High Pressure Sodium Lamps

Enclosed Rated *High Pressure Sodium Lamps*

Watts	Order Code	Product Description	Bulb	Base	Bulb Finish	Operating Position	CCT	ANSI Code	Case Pack
50	23002	LU50/MED/ECO	E17	Medium (E26)	Clear	Universal	2100K	S68	12
70	23004	LU70/MED/ECO	E17	Medium (E26)	Clear	Universal	2100K	S62	12
	23012	LU70/ECO	E23.5	Mogul (E39)	Clear	Universal	2100K	S62	12
100	23006	LU100/MED/ECO	E17	Medium (E26)	Clear	Universal	2100K	S54	12
	23007	LU100/D/MED	E17	Medium (E26)	Coated	Universal	2100K	S54	12
	23014	LU100/ECO	E23.5	Mogul (E39)	Clear	Universal	2100K	S54	12
150	23008	LU150/55/MED/ECO	E17	Medium (E26)	Clear	Universal	2100K	S55	12
	23016	LU150/55/ECO	E23.5	Mogul (E39)	Clear	Universal	2100K	S55	12
250	23019	LU250/ECO	ED18	Mogul (E39)	Clear	Universal	2100K	S50	36
400	23022	LU400/ECO	ED18	Mogul (E39)	Clear	Universal	2100K	S51	36
1000	23025	LU1000/ECO	ED25	Mogul (E39)	Clear	Universal	2100K	S52	12

ED17



E23.5



ED18



E25



HID BALLAST KITS, CAPS AND IGNITORS



Metal Halide Standard and Pulse Start Ballasts Kits

Watts	Order Code	Product Description	Voltage (60Hz)	ANSI Code	Core
70	V90D5833K	70W PSMH QUAD HX	120/208/240/277	M98	3X4
100	V90D5932K	100W PSMH QUAD HX	120/208/240/277	M90	3X4
125	V90J8811K	125W PSMH TRI CWA	120/277/347	M150	3X4
150	V90D7130K	150W PSMH QUAD HX	120/208/240/277	M102	3X4
175	V90D6112K	175W/MH QUAD CWA	120/208/240/277	M57	3X4
	V90J6112K	175W/MH TRI CWA	120/277/347	M57	4X4
250	V90D6215K	250W MH QUAD CWA	120/208/240/277	M58	4X4
	V90J6215K	250W MH TRI CWA	120/277/347	M58	4X4
	V90D8411K	250W PSMH QUAD CWA	120/208/240/277	M153	4X4
	V90D8412K	250W PSMH QUAD CWA	120/208/240/277	M153	4X4
320	V90D7413K	320W PSMH QUAD CWA	120/208/240/277	M154	4X4
350	V90D7513K	350W PSMH QUAD CWA	120/208/240/277	M131	4X4
400	V90AM6411K	400W MH QUINT CWA	120/208/240/277/480	M59	4X4
	V90J6414K	400W MH TRI CWA	120/277/347	M59	4X4
	V90AM7610K	400W PSMH QUINT CWA	120/208/240/277/480	M155	4X4
	V90D7613K	400W PSMH QUAD CWA	120/208/240/277	M155	4X4
	V90J7612K	400W PSMH TRI CWA	120/277/347	M155	4X4
450	V90J8511K	450W PSMH TRI CWA	120/277/347	M144	4X4
575	V90AM5510K	575W PSMH QUINT CWA	120/208/240/277/480	M178	4X4
	V90D5510K	575W PSMH QUAD CWA	120/208/240/277	M178	4X4
1000	V90AM6514K	1000W MH QUINT CWA	120/208/240/277/480	M47	4X6
	V90J6517K	1000W MH TRI CWA	120/277/347	M47	4X6
	V90AM7810K	1000W PSMH QUINT CWA	120/208/240/277/480	M141	4X6
1500	V90D6612K	1500W MH QUAD CWA	120/208/240/277	M48	4X6

Notes: All ballast kits are sold individually boxed and include prewired capacitor & ignitor (when required) plus universal mounting brackets

HPS Ballast Kits

Watts	Order Code	Product Description	Voltage (60Hz)	ANSI Code	Core
70	V90D1233K	70W HPS QUAD HX	120/208/240/277	S62	3X4
100	V90B1322Ki	100W HPS 120 RCTR	120	S54	E&I
	V90D1333K	100W HPS QUAD HX	120/208/240/277	S54	3X4
150	V90D1435K	150W HPS QUAD HX	120/208/240/277	S55	3X4
	V90J1434K	150W HPS TRI HX	120/277/347	S55	3X4
250	V90AM1710K	250W HPS QUINT CWA	120/208/240/277/480	S50	4X4
	V90J1711K	250W HPS TRI CWA	120/277/347	S50	4X4
400	V90AM1910K	400W HPS QUINT CWA	120/208/240/277/480	S51	4X4
	V90J1911K	400W HPS TRI CWA	120/277/347	S51	4X4

Capacitors

Product Code	Type	Micro-Farads	VAC
ACG033	Dry Film	6	330
ACG310	Dry Film	8	280
ACG279	Dry Film	10	400
ACG321	Dry Film	12	330
ACG277	Dry Film	15	400
ACG301	Dry Film	16	330
ACB327OV	Oil Cap	22	525
ACG247	Dry Film	24	400
ACB220OV	Oil Cap	24	480
ACG278	Dry Film	26	400
ACB264OV	Oil Cap	26	525
ACB256OV	Oil Cap	32	525
ACG255	Dry Film	55	300

Replacement Ignitors

Product Code	Product Description
BVS004A	35-150W HPS REACTOR
BVS005A	200-430W HPS
BVS006A	35-150W HPS
BVS020	875-1000W HPS/PSMH
BVS032	Low Watt PSMH HX
BVS041	Mid Watt PSMH CWA

Replacement Sockets

Standard medium and mogul enclosed-rated (E26, E39), open-rated (EX26, EX39), and position oriented mogul (EP39) bases are available. Contact Venture Lighting for more information

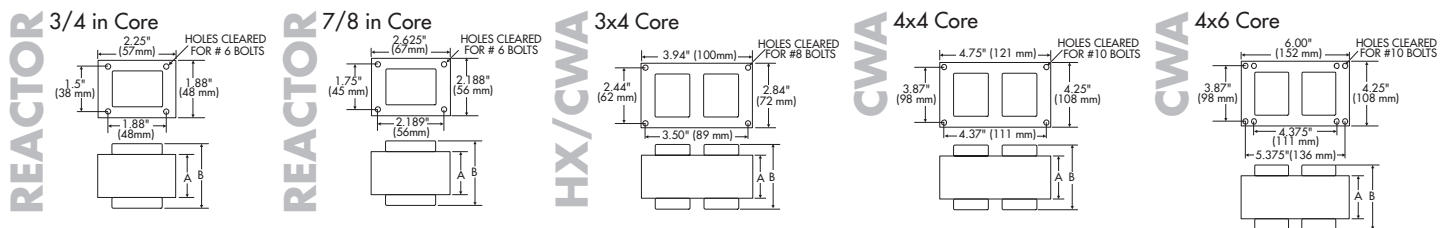

Proper Use of Metal Halide Lamps

Correct Operation and Warnings For High Intensity Discharge Lamps:

High intensity discharge (HID) lamps require auxiliary equipment (ballasts, capacitors and ignitors) to provide the correct electrical values for starting and operating. This auxiliary equipment shall meet the requirements of all relevant Venture specifications, NEMA/ANSI standards and safety standards. Venture Lighting International is not responsible for poor performance, personal injury, property damage, burns or fire from lamps operating on unapproved auxiliary equipment or from lamps being operated in a manner inconsistent with the lamp design.

Power should always be turned off, and preferably locked out, in accordance with OSHA guidelines whenever installation, removal or maintenance is performed on lighting systems. Safety glasses and gloves should be used when installing or removing HID lamps. Lamps should be installed firmly into appropriate lamp sockets, without over-tightening, to avoid loosening from vibration.

HID lamps and arc tubes operate at extremely high temperatures and may shatter as a result of misapplication, system failure or other factors. Scratches on the outer bulb, direct contact with water or excessive installation pressure can cause lamps to break. Breakage may release extremely hot glass and lamp parts into the surrounding environment and raise the risk of fire, personal injury or property damage. Injury may also be caused by ultraviolet energy from an unjacketed HID lamp. If the outer jacket should break, immediately turn the power off. Do not remove a lamp until it has completely cooled; then replace it with a new Venture Lighting® lamp. In areas susceptible to contamination by flying glass, where flammable materials are present, or where there is a possibility of personal injury, users should seek additional protective measures by using open fixture (Type-O) lamps and enclosed luminaires.

Luminaire Requirements and Operating Positions

It is imperative that users adhere to specified luminaire and lamp operating positions and requirements. The operation of lamps in positions other than those specified can result in severe reductions in lamp performance, including lamp life, light output and color. Incorrect operating positions can also create the possibility of an early failure.

Refer to each lamp's technical data specification sheet to determine the correct operating position and luminaire requirements. Also, refer to the diagrams on this page to determine allowable operating positions.

Federal Compliance - Metal Halide Lamps:

Venture Lighting lamps comply with USA Federal Standard 21 CFR 1040.30 and Canada Standard SOR/80-381. The FDA requires the following safety warning statement for all metal halide lamps:

“WARNING: This lamp can cause serious skin burn and eye inflammation from shortwave ultraviolet radiation if outer envelope of the lamp is broken or punctured and the arc tube continues to operate. Do not use where people will remain for more than a few minutes, unless adequate shielding or other safety precautions are used. Lamps that will automatically extinguish when the outer envelope is broken or punctured are commercially available.”

Careful adherence to the previously mentioned precautions may not eliminate all possible risks associated with the use of metal halide lamps, but it will reduce the likelihood of personal injury or property damage.

Warning Notices:

WARNING: THESE INSTRUCTIONS MUST BE FOLLOWED TO AVOID POSSIBLE EARLY FAILURE OF THE LAMP. Venture Lighting will not be responsible for poor lamp performance, personal injury, property damage, burns or fire resulting from failure to follow these instructions.

- Operate lamp in the specified burning position with compatible electrical equipment. The ANSI code on the Venture lamp must match the code on the ballast or luminaire. If in doubt, consult with Venture Lighting or the luminaire manufacturer.
- Operate pulse start metal halide lamps with appropriate pulse start metal halide ballasts and lampholders that can withstand a 4000 volt pulse. The substitution of standard probe start (non-pulse start) metal halide lamps will result in poor performance and is not recommended.
- Operate high pressure sodium lamps with appropriate high pressure sodium ballasts and lampholders that can withstand a 4000 volt pulse (except 600W, 750W, and 1000W lamps which require lampholders that can withstand a 5000 volt pulse).
- Electrically insulate any metal bulb supports in the luminaire to avoid decomposition of glass.
- Protect lamp from direct contact with rain, sleet or snow to avoid breakage from thermal shock.
- This is a vacuum-jacketed lamps and may implode if broken; avoid skin contact with broken lamp pieces. Wear safety glasses and gloves when installing or removing high intensity discharge lamps.
- Install lamp firmly, but not forcibly, into the socket to minimize loosening from vibration.
- Do not use excessive force as the glass bulb may break.
- During lamp replacement, turn power off and let lamp cool before removal to avoid potential electrical shock and/or burns.

- Replace bulb if scratched, cracked or damaged.
- If the outer envelope breaks or is punctured and lamp continues to operate, immediately turn power off and remove lamp after it has cooled.

Positions of Operation



Universal
Any Position



Vertical $\pm 15^\circ$



HOR $\pm 15^\circ$
Horizontal



HOR $\pm 45^\circ$
Horizontal



HOR $\pm 60^\circ$
Horizontal



H $\pm 75^\circ$
Horizontal



BU $\pm 15^\circ$
Base Up



BU $\pm 90^\circ$
Base Up



BU $\pm 105^\circ$
Base Up



End-of-Life and Reduction of Risk

At end-of-life, the vast majority of metal halide lamps will simply fail by not reigniting. On rare occasions, metal halide lamps may fail in a violent manner. The possibility of this type of failure is significantly reduced by group re-lamping at or before the rated end of life (see Group Re-lamping). In any application where enclosed rated (Type-E) lamps are operated continuously (24 hours per day, seven days per week), the lamps should always be turned off for a period of at least 15 minutes each week; this precaution can reduce the possibility of violent failures. This procedure is not required with Venture's open rated (ANSI Type-O) shrouded lamps. These lamps are easily identified by the prefix "MP," "MPI," "MPL," "MPE," "MPSE" or "MPC" in the lamp description code.

Starting and Restarting Characteristics

Venture's Uni-Form® pulse start metal halide lamps start at an ambient temperature of -40°C (-40°F) or higher. Full light output does not occur immediately when power is applied to any metal halide lamp; after starting, there is a time delay of at least three to six minutes before lamps reach full light output.

After lamps have started, a power interruption of 1/4 cycle (1/240th of a second) or more may cause the lamps to extinguish. Several minutes are required before an arc can be re-established by the ballast and full light output achieved. The exact time is dependent on a number of

factors including lamp wattage, ballast and ignitor characteristics, ambient temperature, fixture dimensions and supply voltage.

The time needed to establish full light output can be as short as three minutes and as long as 15 to 20 minutes. Venture's exclusive Uni-Form formed-body arc tube provides warm-up and hot re-strike in up to 60% less time than standard probe start metal halide lamps.

Lamp Life

Lamp life is an important consideration when purchasing a new, retrofit or replacement lamp. Two very different and distinct terms describe life: "rated life" and "economic life."

Rated Life

Rated life for metal halide lamps is a value of lamp life expectancy based on laboratory and field tests of representative lamps, operating on approved ballasts, with a burn cycle of at least 10 hours per start. The lamp life is determined when 50% of metal halide lamps initially installed are still operating

Operating Position

Various operating conditions affect lamp life. One key factor is operating position. Position-oriented lamps (designed to operate in one specific position) are tested and rated based on that designated position; operating these lamps in any other position can dramatically shorten life, reduce lumen output and cause color shift. Lamps designated universal can be operated in any position, however, life expectancy and lumen output are sacrificed in certain positions;

published "rated life" for universal lamps is based on operation in the vertical position, "rated life" for universal lamps operated horizontally is 75% of the published rating.

Economic Life

Economic life refers to the hours of operation during which a lamp is designed to provide optimum light output and color quality as well as lowest replacement cost. Economic life describes actual lamp life better than rated life because rated life does not account for the lumen depreciation and color shift that occur as lamps age. The economic life of lamps is generally 60% to 75% of the lamp rated life. Though economic life is important when considering a lighting system, lamp data tables show rated life because they provide a comparison with other lamp manufacturers' ratings.

Lamp Mortality & Maintenance Curves

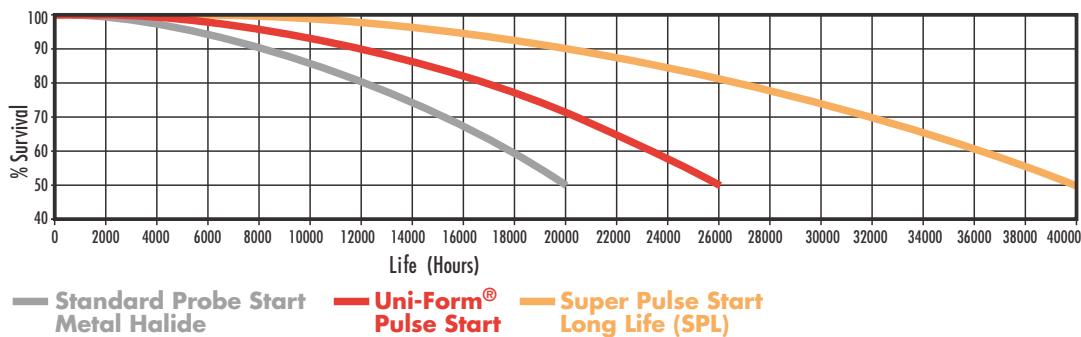
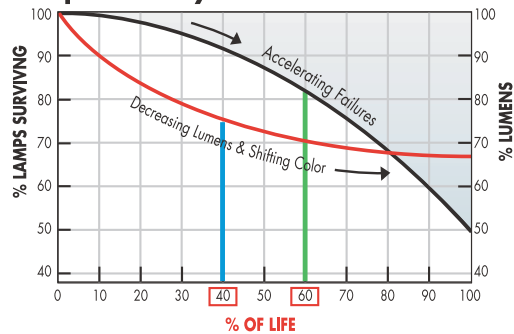

Group Relamping Effective Lighting Management

Group re-lamping offers significant savings in time and labor costs over spot replacing single failed lamps. Regularly scheduled maintenance based on economic lamp life keeps a lighting system functioning at its maximum.

This provides:

1) Optimum Light Output:

Light levels are at peak performance when a lighting installation is new. Many standard probe start metal halide lamps decrease to as low as 25% of initial light output by the end of rated life. A number of factors may accelerate this reduction in efficacy (lumens per watt). Group re-lamping at economic life keeps the light levels from dropping significantly; it also provides an opportunity to remove dirt accumulation in the luminaire. Cleaning during group re-lamping saves time and helps maintain optimum light levels. A cleaner, well-lit environment increases safety and security, contributes to higher worker productivity and creates a better impression for visitors.

2) Aesthetic Quality:

The quality of light changes over economic life; most of this shift occurs in the last 25% of rated life. This causes old lamps to appear blue or pink, especially when compared to new lamps. All the lamps in an area will generally change color together. However, lamps that are spot replaced will look noticeably different than those around them.

3) Optimum Energy Efficiency:

While the light output of a metal halide lamp decreases over the life span, the lamp will still consume the same (or sometimes more) electricity. Since energy is the largest cost of lighting, group re-lamping prevents almost half of the energy from being wasted by under-performing lamps. For example, a 400 watt lamp may consume \$800 of electricity over its rated life. After 60% of rated life, about \$320 is wasted on lamps providing less than mean lumens. Spot re-lamping wastes energy dollars; the cost of a new lamp and the labor to install it as part of group re-lamping is generally less than 5% of the total energy cost.

4) Cost Effective Replacement:

Group re-lamping, as a planned maintenance program, reduces labor costs and interference with facility operations. Spot re-lamping often takes an employee away from regular duties to replace a single burned out lamp; this inconvenience grows as lamp failures increase towards the end of rated life. Group re-lamping eliminates workday disruptions, allowing re-lamping to take place during normal shutdown periods. Also, group re-lamping at economic life is a practical way to sustain workers' visual acuity with a bright workplace environment.

MAINTENANCE PROGRAM TYPICAL LAMP LUMEN PERFORMANCE

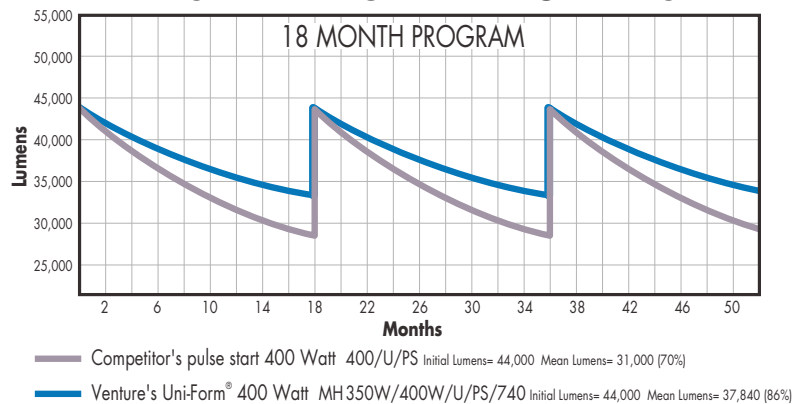

MAINTENANCE PROGRAM TYPICAL LAMP LUMEN PERFORMANCE

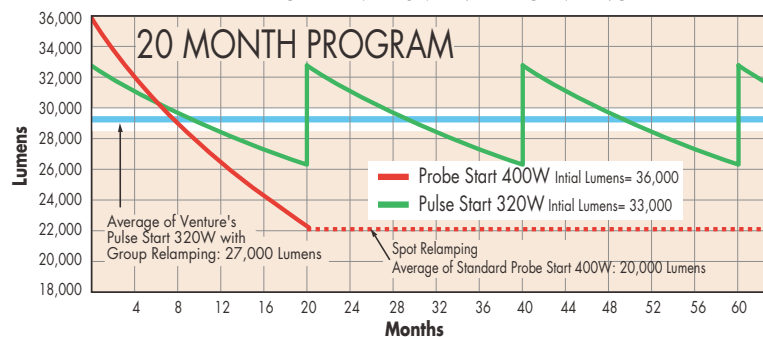

Group Relamping Effective Lighting Management

Group re-lamping offers significant savings in time and labor costs over spot replacing single failed lamps.

Open Rated Lamps

Open luminaires offer significant advantages over enclosed luminaires. They do not require cover lenses which reduce light output and accumulate dirt. In addition, enclosed luminaires make lamp replacements more difficult. For safety, open luminaires need open rated (ANSI Type-O) metal halide lamps.

To reduce the risk of liability, lighting specifiers need to be aware of the criteria for a true open rating and what the Type-S or Type-O designations indicate about lamp construction.

ANSI Lamp Designations

The American National Standards Institute (ANSI) currently classifies metal halide lamps with three possible ratings: Type-O, Type-S and Type-E.

Type-O open fixture rated lamps characteristics:

1. There is a shroud around the arc tube, which helps prevent damage to the outer bulb in the event of an arc tube rupture.

2. The base is open fixture rated, such as an EX39 mogul base or narrow neck bulb with a medium base, both of which require special exclusionary sockets.

3. They pass the ANSI C78.389 lamp containment test, where arc tubes are forcibly ruptured and must be contained within the outer jacket.

All "MP," "MPI," "MPL," "MPE," "MPSE" and "MPC" lamps produced by Venture Lighting meet the requirements to be rated Type-O and can be used with confidence.

Type-S lamps do not include internal protection against failure. These lamps are not permitted in new open luminaires, according to UL1598 and the NEC.

Type-E lamps are rated for use only in enclosed luminaires.

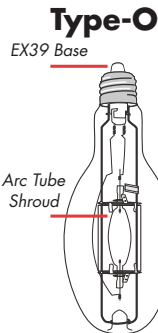

Type-E, S

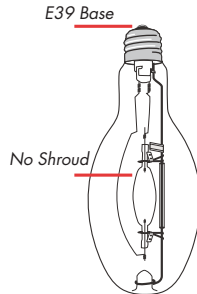

In September 2010, UL1598 became effective with requirements for open metal halide luminaires and Type-O lamps. These requirements are the same as those in the 2005 National Electrical Code (NEC) published by the National Fire Protection Agency (NFPA).

NEC section 410.73(F)(5) states that "Luminaires (fixtures) that use a metal halide lamp other than a thick-glass parabolic reflector lamp (PAR) shall be provided with a containment barrier that encloses the lamp, or shall be provided with a physical means that only allows the use of a lamp that is Type-O."

Open luminaires require sockets that only accept Type-O lamps (pink EX39 mogul sockets or E26 narrow neck medium sockets) in order to prevent accidental use of Type-S or Type-E lamps.

We Build Lighting Systems With Safety in Mind!

For over 20 years, Venture has been leading the way by producing metal halide lamps that contain protective shrouds. Venture Lighting provides the industry's widest selection of lamps that meet ANSI C78.389 testing requirements for a rating of Type-O. Venture is building lighting systems with the safety of you and your customers in mind.

Venture's Open Rated Lamp Benefits

Venture's MP, MPI, MPL, MPE, MPSE and MPC lamps:

- Meet requirements of the UL1598 and the National Electric Code
- Meet ANSI criteria for a Type-O rating
- No luminaire lens required, delivering more light - Lumen loss with a lens is up to 16%
- Can be operated continuously; no shut off required
- Contain shrouds with most wattages
- Operate in open or enclosed luminaires



Ruptured arc tube contained within the intact outer jacket of a Venture MP lamp



Footnotes:

1. NEMA white paper: LSD 71-2020
2. FMGlobal Property Loss Prevention Data Sheets, 5-21, Rev. May 2001.



WARRANTY INFORMATION

LED Lamps and Retrofit Kits Warranty Information

This Venture lighting product is warranted for the period of 5 years, as specified, from the date of purchase against defects in material and workmanship. The determination of whether the product is defective shall be made by Venture Lighting.

This limited warranty shall only apply if the Venture Lighting product has been installed and operated (i) in

LED Product Type	Rated Life	Warranty Period	Usage
LED T8 Lamps	50,000 hrs	5 years	12 hrs/day annually
LED Retrofit Lamps	50,000 hrs	5 years	12 hrs/day annually
LED Downlight Kits	35,000 hrs	5 years	12 hrs/day annually

compliance with the specifications and guidelines set forth herein, on the product label and packaging, and on the Venture Lighting website, (ii) in accordance with the National Electric Code (NEC), the Standards for Safety of Underwriters' Laboratory, Inc. (UL), the Standards for the American National Standards Association (ANSI), or in Canada, with the standards of the Canadian Standards Association (CSA), and (iii) in lighting equipment designed and approved for the application and in environmental conditions within the normal specified operating range of the product.

This limited warranty does not apply to loss or damage to the product caused by: negligence; abuse; misuse; mishandling; improper installation, storage, or maintenance; damage due to fire or acts of God; vandalism; civil disturbances; power surges; improper power supply; electrical current fluctuations; corrosive environment installations; induced vibration; harmonic oscillation or resonance associated with the movement of air currents around the product; alteration; accident; failure to follow installation, operating, maintenance or environmental instructions.

The warranty terms contained herein shall be the sole and exclusive remedy of the purchaser of Venture Lighting products and state Venture Lighting's entire liability and obligation to such purchaser. NO WARRANTY OF FITNESS FOR ANY SPECIFIC OR PARTICULAR PURPOSE IS MADE OR IS TO BE IMPLIED. NO OTHER WARRANTIES APPLY.

If the product is defective, this product will be repaired or replaced, at Venture Lighting's option. This warranty is expressly limited to the repair or replacement of the product. This warranty gives the customer specific legal rights, which vary from state to state and province to province. No distributor, salesperson, dealer, retailer or other representative has the authority to change or modify this warranty, either orally or in writing, in any respect.

WARRANTY IS VOID IF PRODUCT IS NOT USED FOR THE PURPOSE FOR WHICH THIS PRODUCT IS DESIGNED.

LED Fixtures Warranty Information

This Venture Lighting product is warranted for the period of 5 years, as specified, from the date of purchase against defects in material and workmanship. The determination of whether the product is defective shall be made by Venture Lighting. A Venture Lighting product will not be considered defective under this warranty solely because a small number of separate LED components fail to operate (i.e. provide light) when the number of such failed components is less than 10% of the total number of light emitting components which are part of the product.

This limited warranty shall only apply if the Venture

Lighting product has been installed and operated (i) in compliance with the specifications and guidelines set forth herein, on the product label and packaging, and on the Venture Lighting website, (ii) in accordance with the National Electric Code (NEC), the Standards for Safety of Underwriters' Laboratory, Inc. (UL), the Standards for the American National Standards Association (ANSI), or in Canada, with the standards of the Canadian Standards Association (CSA), and (iii) in lighting equipment designed and approved for the application and in environmental conditions within the normal specified operating range of the product.

This limited warranty does not apply to loss or damage to the product caused by: negligence; abuse; misuse; mishandling; improper installation, storage, or maintenance; damage due to fire or acts of God; vandalism; civil disturbances; power surges; improper power supply; electrical current fluctuations; corrosive environment installations; induced vibration; harmonic oscillation or resonance associated with the movement of air currents around the product; alteration; accident; failure to follow installation, operating, maintenance or environmental instructions.

The warranty terms contained herein shall be the sole and exclusive remedy of the purchaser of Venture Lighting products and state Venture Lighting's entire liability and obligation to such purchaser. NO WARRANTY OF FITNESS FOR ANY SPECIFIC OR PARTICULAR PURPOSE IS MADE OR IS TO BE IMPLIED. NO OTHER WARRANTIES APPLY.

If the product is defective, this product will be repaired or replaced, at Venture Lighting's option. This warranty is expressly limited to the repair or replacement of the product. This warranty gives the customer specific legal rights, which vary from state to state and province to province. No distributor, salesperson, dealer, retailer or other representative has the authority to change or modify this warranty, either orally or in writing, in any respect. WARRANTY IS VOID IF PRODUCT IS NOT USED FOR THE PURPOSE FOR WHICH THIS PRODUCT IS DESIGNED.

Poles Warranty Information

See Venture Lighting's website for pole warranty information

HID Lamp Warranty Information

1. Upon receipt and/or initial installation by the customer, Venture Lighting International will replace any lamp determined to be defective in materials, workmanship, or proper operating parameters.

2. Venture Lighting will replace any lamp that fails within one year from the purchase date (based on 5000 hrs./yr. operation) when the failure is determined to be lamp related (applies to lamps with life ratings of greater than 7500 hrs.).

3. During economic life, Venture Lighting will supply replacement lamps for failed lamps in excess of the failure rate projected by life expectancy curves, when the lamps are operated correctly and in accordance with the guidelines outlined in this technical guide.

All performance ratings are based on lamp testing at rated watts, under controlled conditions, using primary AC electrical circuits with the highest quality auxiliary equipment. The performance of any lamp may vary somewhat under typical service conditions. All lamp specifications and ratings are subject to change without notice.

Limited Warranty on HID Ballasts

Venture® ballast products are warranted free from manufacturing and workmanship defects for a period of two years from the date of shipment. During this period, Venture will, at its option, repair or replace ballast products which prove to be defective or out of specification. This warranty is granted by Venture only to the original purchaser or first end-user of such ballast products.

HID Product Type	Warranty Period	This warranty is conditional upon installation, maintenance and operation in accordance with Venture's instructions and specifications set forth in the purchase order or contract at the time of order and in accordance with the standards of The National Electric Code (NEC), Underwriters' Laboratory, Inc. (UL) and the American National Standards Institute (ANSI) and, in Canada, with the standards of the Canadian Standards Association (CSA). Damage by misuse or abnormal conditions of storage, installation, maintenance or operation, including, but not limited to, excessive temperatures or evidence of partial or complete disassembly beyond normal maintenance or expansion procedure void this warranty in its entirety. The conditions of any tests performed concerning any ballast product claimed to be defective in accordance with the terms of this warranty shall be mutually agreed upon in writing between the original purchaser or first end-user and Venture and Venture may be represented at any such test.
Lamps	One Year	
All SPL Lamps	Two Years	
Magnetic Ballasts	Two Years	

No implied statutory warranty of merchantability or fitness for a particular purpose shall apply beyond the afore-mentioned warranty period. This warranty excludes other warranties, expressed or implied and is the exclusive remedy of the claimant. Venture shall not be liable for any special, indirect or consequential damages. Venture's liability on any claim of any kind, nature or description arising out of, resulting from or concerning any aspect of this warranty agreement or from the product or services furnished hereunder shall not exceed the price of the specific ballast or ballasts which give rise to the claim. For warranty service or repair, the buyer shall prepay all shipping charges to Venture and Venture shall pay shipping charges to return the repaired or replaced item to the buyer. However, the buyer shall pay all shipping charges, duties and taxes for products returned to Venture from a country other than that of the United States of America.

No implied statutory warranty of merchantability or fitness for a particular purpose shall apply beyond the afore-mentioned warranty period. This warranty excludes other warranties, expressed or implied and is the exclusive remedy of the claimant. Venture shall not be liable for any special, indirect or consequential damages. Venture's liability on any claim of any kind, nature or description arising out of, resulting from or concerning any aspect of this warranty agreement or from the product or services furnished hereunder shall not exceed the price of the specific ballast or ballasts which give rise to the claim. For warranty service or repair, the buyer shall prepay all shipping charges to Venture and Venture shall pay shipping charges to return the repaired or replaced item to the buyer. However, the buyer shall pay all shipping charges, duties and taxes for products returned to Venture from a country other than that of the United States of America.

HID Product replacement/liability limits

The foregoing warranty shall be the sole and exclusive remedy of the purchaser and Venture's sole and exclusive remedy to the purchaser. NO WARRANTY OF FITNESS FOR ANY SPECIFIC OR PARTICULAR PURPOSE IS MADE OR IS TO BE IMPLIED. NO OTHER WARRANTY APPLIES. Venture will not, under any circumstance, whether as a result of breach of contract, warranty tort or otherwise, be liable for any costs or damages, including lost profits or revenues, incidental, special or consequential damages.

Some states or provinces do not allow the exclusion or limitation of incidental or consequential damages, so the above limitation or exclusion may not apply to you. This warranty gives you specific legal rights, and you may also have other rights which may vary from state to state and province to province. No distributor, salesperson, dealer, retailer or other representative has the authority to change or modify this warranty, either orally or in writing, in any respect.



VALUE • FLEXIBILITY • PERFORMANCE

2022 CATALOG



LED • CONTROLS • HID

(800) 451-2606

6675 Parkland Blvd., Suite 100

Solon, Ohio 44139 USA

E-mail: Venture_Lighting@VentureLighting.com

VentureLighting.com

