

TENNIS LIGHTING

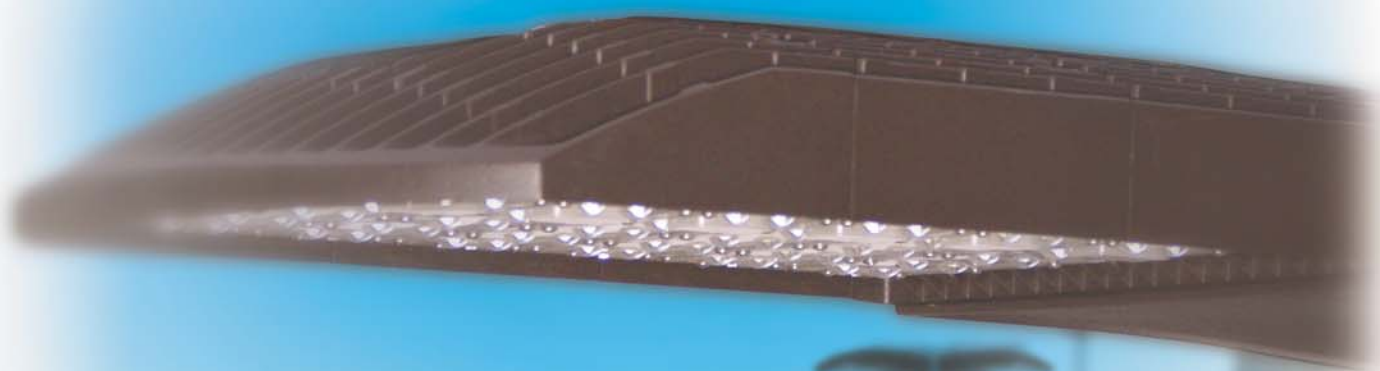

CROSSCOURT



LIGHTING SOLUTIONS
FROM A LEADER IN LIGHT SOURCE TECHNOLOGY



WELCOME TO VENTURE LIGHTING SOLUTIONS



VENTURE
LIGHTING

Experience better tennis lighting, with less glare. Venture Lighting has combined LED efficiency with specialty optics to create proper light levels in the right places of any tennis court. Venture's CrossCourt system requires no tilting and as such is glare-free, Dark-Sky, and neighborhood friendly. Eliminate the need to tilt the fixture and brighten the playing field. Venture's CrossCourt wins match, set - game over.

- Reduced glare
- Superior spill light control
- Longer product life - Reduced maintenance costs
- Ability to illuminate individual courts when the entire complex is not in use
- Lower visual impact on the surrounding environment
- Perfect for lower poles
- High performance, full cut-off LED fixtures
- Aerodynamic, low-profile
- Over 60% energy reduction vs 1000W MH fixtures
- Greater than 500,000 hours rated life L₇₀ @25°C ambient temperature
- Instant on and dimmable
- 5-year warranty



energy saving



longer life



superior performance



easy to install



5 year warranty



all weather



technical support

CROSSCOURT



TENNIS LIGHTING MADE BRIGHTER

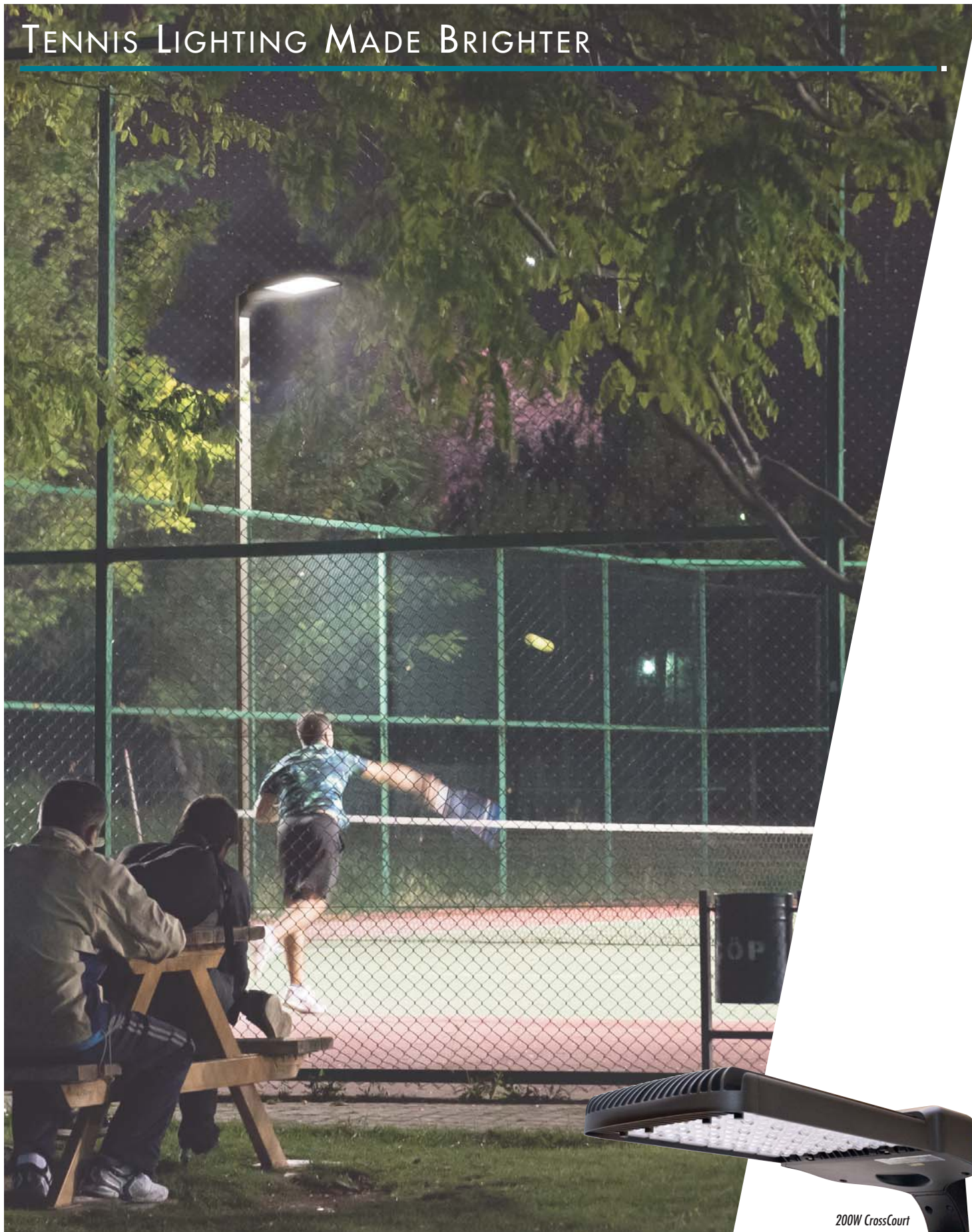

200W CrossCourt

LIGHTING SOLUTIONS FROM A LEADER IN LIGHT SOURCE TECHNOLOGY



DESIGNED SPECIFICALLY FOR TENNIS LIGHTING

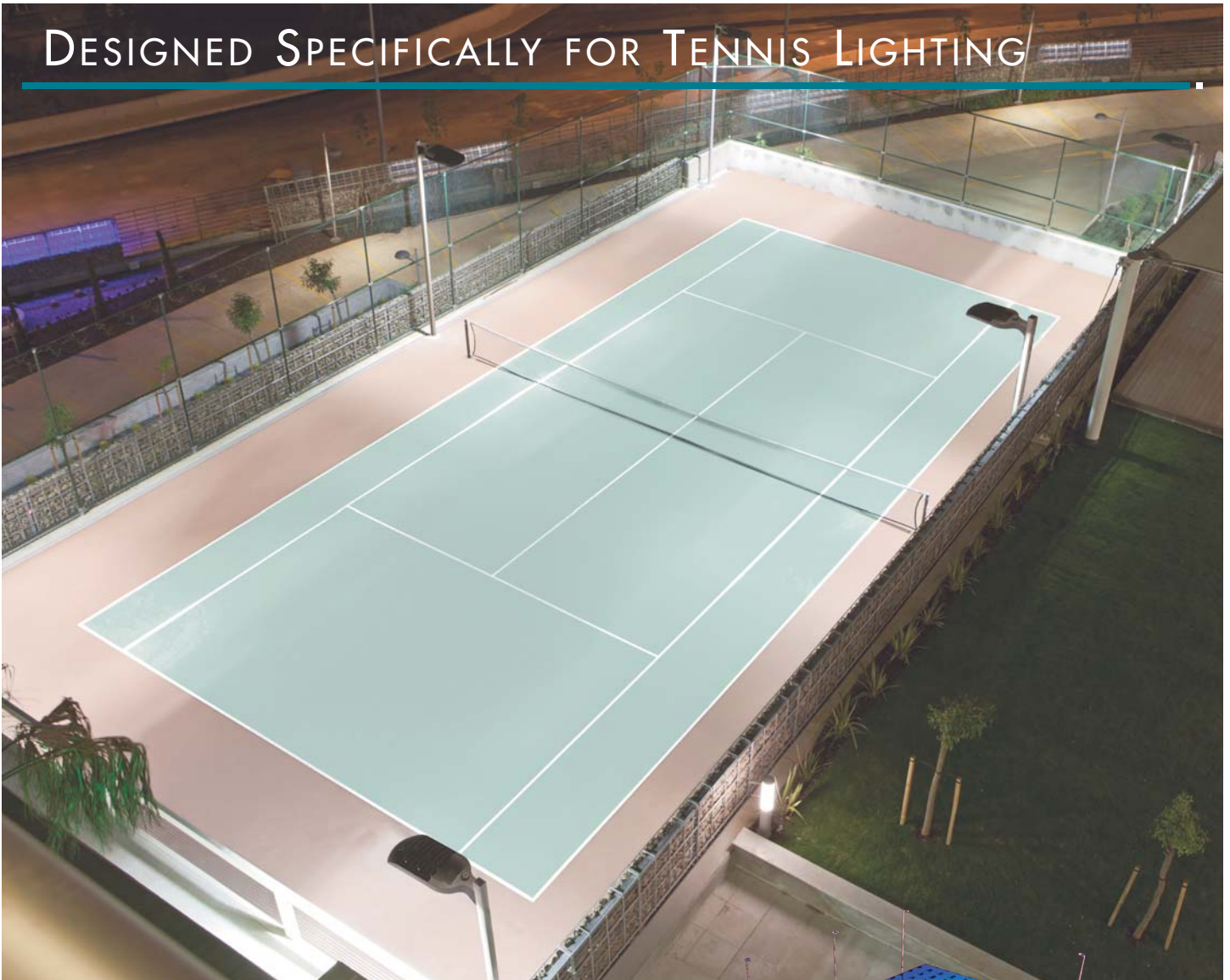

CrossCourt

CrossCourt is the Venture Lighting's latest series of LED fixtures designed specifically for tennis lighting applications. With low profile design, featuring long life and low maintenance, CrossCourt fixtures are perfect for new construction and easy replacement of existing tennis lighting fixtures. They are the perfect match of custom optics and fixture efficiency from a lighting industry leader.

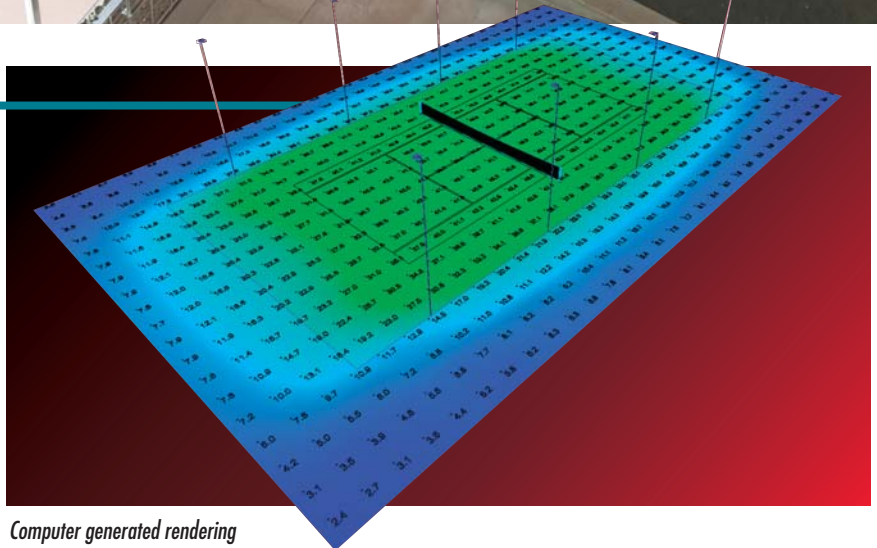

*Computer generated rendering
Fixtures mounted at 30' AFG
Workplane is at 3' AFG
Quantity: 8
Wattage: 480W; Fixture Lumens: 51453
Average footcandle (Courtside): 35.96
Max. footcandle (Courtside): 43.3*

CROSSCOURT



Benefits and Features

- Rugged die cast housing with a durable powder coat finish
- Vandal resistant polycarbonate lens
- Optical chamber is sealed and gasketed
- Capable of adding motion/photocell sensor
- Operating temperature range of -40° C to 40° C
- Instant on - No need to wait for a fixture to warm-up
- 10kA surge protection
- Over 60% energy reduction vs 1000W MH fixtures
- 5 year warranty
- UL Listed for wet locations
- Universal 120-277V 50/60 Hz input or 347-480V input
- Each fixture will be supplied with a 7-pin receptacle and a shorting cap
- 0-10V DC dimming standard to maximize energy savings
- Reduced glare
- Superior spill light control
- Longer product life - Reduced maintenance costs
- Ability to illuminate individual courts when coupled with controls
- Lower visual impact on the surrounding environment
- Perfect for lower poles
- Lightweight and easy to install

ORDER TODAY!

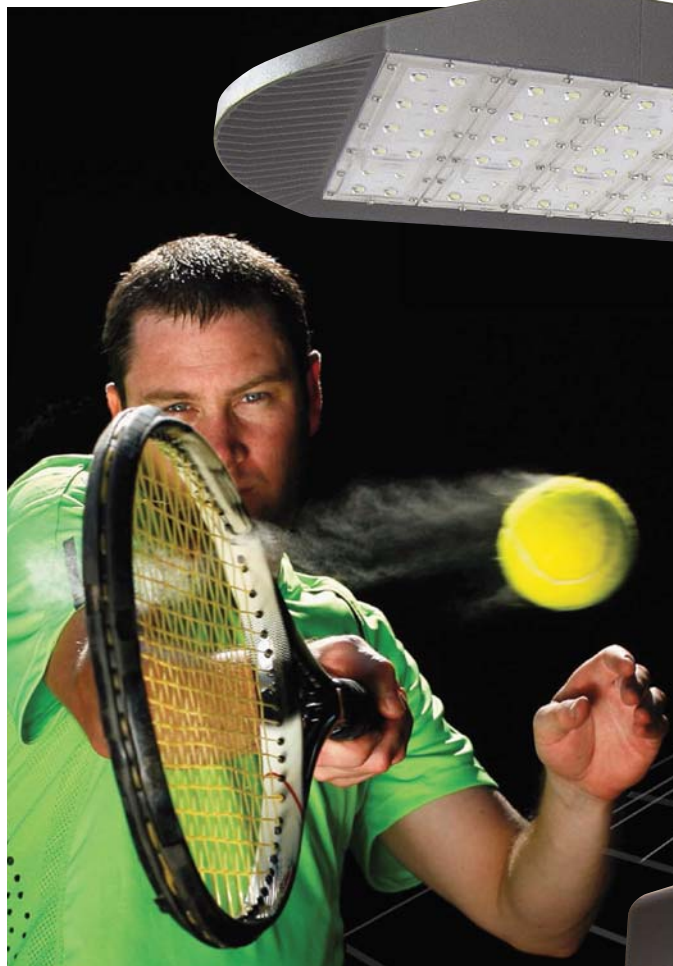

480W CrossCourt



200W CrossCourt

Ordering & Model Number Information

Choose nomenclature that suits application. Example: **ENV-200CTT-ABZ-M12**

ENV-	200	C	TT-	A	BZ-	M12
Fixture Type	Wattage	Color Temp.	Optics	Voltage	Fixture Finish	Options
ENV - Venture's LED Tennis Fixture	<input type="checkbox"/> 120 - 120W <input type="checkbox"/> 150 - 150W <input type="checkbox"/> 200 - 200W <input type="checkbox"/> 380 - 380W <input type="checkbox"/> 480 - 480W	<input type="checkbox"/> C - 5000K <input type="checkbox"/> N - 4000K*	<input type="checkbox"/> TT - Tennis	<input type="checkbox"/> A - 120-277V <input type="checkbox"/> B - 347-480V	<input type="checkbox"/> BZ - Bronze	"Blank" - No motion sensor <input type="checkbox"/> M12 - 120-277V motion sensor <input type="checkbox"/> M34 - 347-480V motion sensor

Notes: * Contact for lead time
 Other fixture finish colors available, contact for details



Wattage	Lumen Output	Color Temp.	CRI	Lumen Maint. @50,000 hours [†]	Calc. L70@25°C Amb.(hrs) [†]	Fixture Color	Amperage Draw (A)				Replaces Existing HID Wattages
							120V	277V	347V	480V	
120W	12800	4000K	70	99%	>500,000	Bronze	1.00	0.44	0.36	0.26	175W V, 250W H
120W	12900	5000K	70	99%	>500,000	Bronze	1.00	0.44	0.36	0.26	175W V, 250W H
150W	17100	4000K	70	99%	>500,000	Bronze	1.30	0.55	0.45	0.32	250W V, 400W H
150W	17200	5000K	70	99%	>500,000	Bronze	1.30	0.55	0.45	0.32	250W V, 400W H
200W	24000	4000K	70	99%	>500,000	Bronze	1.70	0.73	0.58	0.43	400W V, 1000W H
200W	24150	5000K	70	99%	>500,000	Bronze	1.70	0.73	0.58	0.43	400W V, 1000W H
380W	39500	4000K	70	89%	>162,000	Bronze	3.20	1.40	1.20	0.82	1000W V, 1000W H
380W	39700	5000K	70	89%	>162,000	Bronze	3.20	1.40	1.20	0.82	1000W V, 1000W H
480W	51200	4000K	70	89%	>162,000	Bronze	4.00	1.80	1.40	1.00	1000W V, 1000W H
480W	51450	5000K	70	89%	>162,000	Bronze	4.00	1.80	1.40	1.00	1000W V, 1000W H

[†] Lumen maintenance data is based on LED testing per IESNA LM-80-08 and projected per IESNA TM-21-11

Photometrics

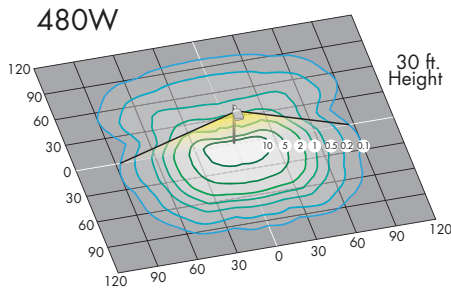

Wattage	B-U-G Rating	Fixture EPA
120W	B3-U3-G3	1.56
150W	B3-U3-G3	1.73
200W	B3-U3-G3	2.08
380W	B4-U0-G4	1.8
480W	B4-U0-G4	1.95

Dimensions

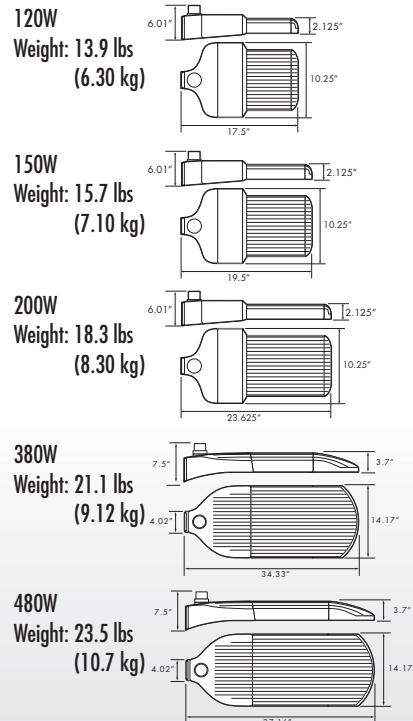

Accessories (Order as separate line items)

Mounting Accessories for 120W through 200W

- EN14178 Round pole straight arm - bronze
- EN26814 Square pole mount - bronze
- EN35512 Adjustable slipfitter - bronze
- EN38419 Mast arm (Horizontal tenon) - bronze
- EN47832 Wall mount - bronze

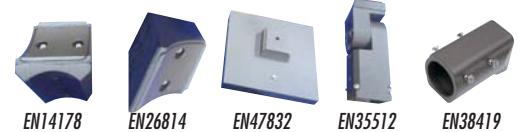

Mounting Accessories for 380W and 480W

- EN14628 Round pole straight arm - bronze
- EN27395 Square pole mount - bronze
- EN36717 Adjustable slipfitter - bronze
- EN38159 Mast arm (Horizontal tenon) - bronze



Common Accessories for All CrossCourt Fixtures

- PH12415 3-Pin Twist lock photocell (120-277V)
- PH81156 3-Pin Twist lock photocell (480V)
- PH87145 3-Pin Twist lock photocell (347V)
- PH81975 Replacement shorting cap
- SP12714 120-277V surge protector
- SP12826 347-480V surge protector





energy saving



longer life



superior performance



easy to install



5 year warranty



technical support

CROSSCOURT LED TENNIS LIGHTING



VENTURE
LIGHTING

LIGHTING SOLUTIONS
FROM A LEADER IN LIGHT SOURCE TECHNOLOGY

(800) 451-2606

Fax: (800) 451-2605
2451 Enterprise Parkway East
Twinsburg, OH 44087 USA
E-mail: venture@adlit.com

VentureLighting.com