

KLR™ Series Three Phase Reactors

PRODUCT SPECIFICATIONS

- Lifetime Warranty
- Performance Guarantee
- K-Rated, UL/ULC-Recognized; CSA-Certified
- 3 Phase, 600V Class
- Gapped Iron Core Inductor
- All Copper Windings
- 40° C Ambient Temp.
- Available with Terminal Options and in NEMA 1
- High quality Bobbin Construction, units 80A and below
- Distributed Gap™ Technology, units 110A and above
- Can tolerate 200% rated I, for at least 3 minutes
- Universal Footprint



Applications

TCI KLR™ series three phase AC reactors are intended for use as input filters for adjustable speed DC drives and as input or output filters for AC-PWM variable frequency drives. Drive performance is significantly improved, the drives input rectifier is protected from failure or damage, and drive harmonic demands are tamed with the addition of a K-rated reactor. KLR reactors act as interface buffers between solid state power circuits and the line or the motor. (Not unlike the surge protector for your desk-top PC). All drives, in any application, will benefit when applied with KLR series reactors.

Before KLR

Drives are susceptible to problems caused at their interface to the line or motor. Some of these issues include AC voltage waveform line notching or cross-talk, DC bus overvoltage trips, inverter overcurrent and overvoltage, and poor total power factor. Since all drives demand nonlinear current and voltage, drives demand currents rich in harmonics.

After KLR

KLR reactors provide additional circuit inductance which slows rapid changes in current that are the heart of the problems listed above.

1.) Voltage line notching, or commutation notching, is caused by SCR phase-controlled rectifiers. KLR reactors provide a voltage-dividing impedance which reduces the depth and rounds the edges of the notches, thereby eliminating drive cross-talk, interference, and equipment damage.

2.) Transient voltages (See Figure 1) on the AC power lines can cause inrush currents to an AC-PWM drive, resulting in an overvoltage condition of the DC bus.

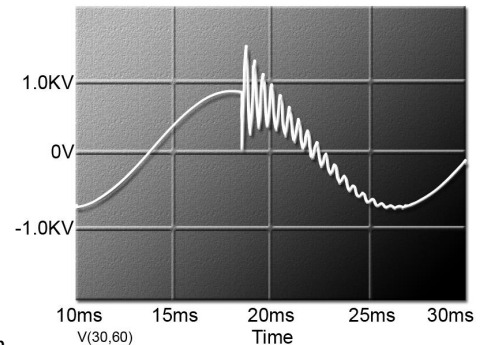

Figure 1



These transient voltage conditions are often caused by utility capacitor switching and will cause VFDs to shut down without warning. The addition of a KLR reactor will limit the magnitude of inrush current, preventing trips and component failures. (See Figure 2.)

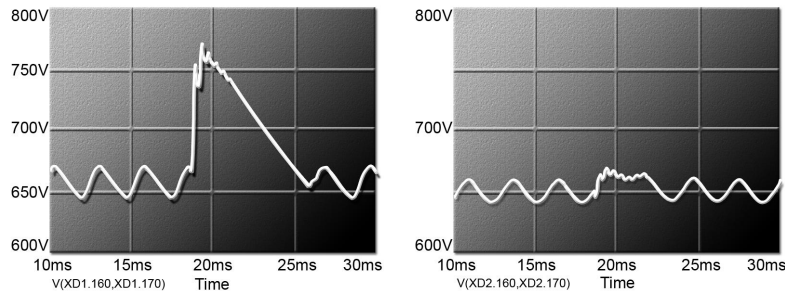

Figure 2

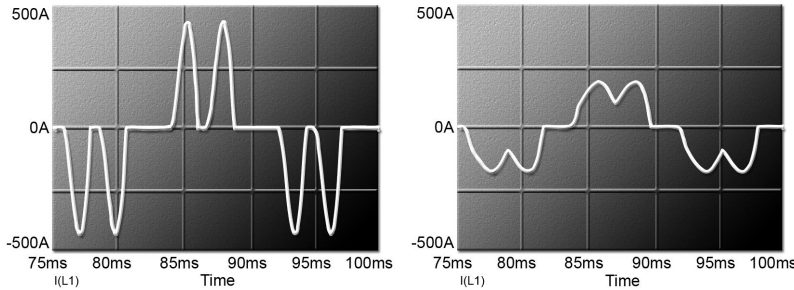
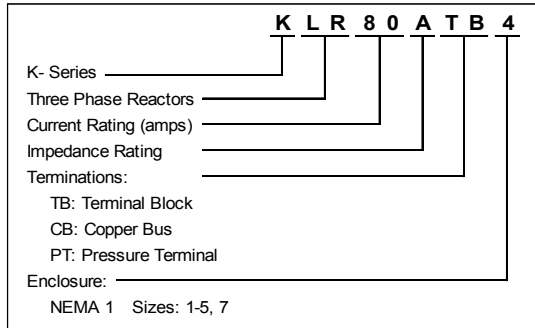

Figure 3



3.) When used as output filters, KLR reactors prevent inverter instantaneous overcurrent trips because they provide needed inductance when the load on an inverter has an abnormally high capacitance. For example, if a single inverter is powering multiple motors, the load may look capacitive, causing inverter shutdown.

4.) The addition of a KLR reactor limits inrush current to the rectifier, rounding the waveform, reducing peak currents, and lowering harmonic current distortion. High peak currents may cause “flat-topping” of the voltage waveform. Reducing those peak currents also reduces total harmonic voltage distortion. (See Figure 3.)

5.) The addition of a KLR reactor reduces total RMS current without affecting the work being done. Therefore, total power factor is improved.

Application Instructions

Line reactors are current-rated devices. Therefore, in order to apply one, you simply need to know the full load AMPs of the drive with which it will be used and the amount of impedance that is necessary in the application. (See NEC Table 430.250 for HP Full Load Currents.)

Recommended impedance levels:

- 2.4 to 3% eliminates bus overvoltage tripping.
- 5 to 6% protects against physical damage to most drive components and offers harmonic reduction without added capacitance.
- 1.5% is the recommended input minimum to protect the drive and is the recommended maximum impedance when the filter is used as an output device.

Distributed Gap™ Technology

As reactors and their required air-gaps get bigger, flux fringing and eddy currents can cause heating and insulation breakdown. TCI has addressed this issue in larger KLR reactors by utilizing Distributed Gap™ technology - a construction technique that subdivides a large gap into two or more smaller gaps. A KLR reactor built with this technique will run cooler and last longer than the competition's cheaper single gap products.

Universal Footprint/Termination Options

KLR reactors are available with a universal mounting design. This makes installation much easier for large distributors, systems integrators, and drive manufacturers who have pre-drilled back panels or customers with pre-drilled back panels. Termination options make handling and connection easier.

Drawings/Specifications

AutoCad compatible *.dxf drawings and Sample Bidding Specifications of all KLR units are available at www.transcoil.com or by calling (800) 824-8282.

Manufacturer's Warranty

KLR reactors are warranted against manufacturer's defect for the life of the drive they are installed with.

Performance Guarantee

Properly sized for the application, a KLR reactor is guaranteed to end an AC Drive overvoltage tripping problem. If you install a KLR reactor and a tripping problem remains, TCI will take back the reactor and pay shipping both ways. (Offer valid for 60 days from date of purchase.)

The information contained in this brochure is subject to update without notice.

Part Number	480V HP	575V HP	240V HP	Conn. Type	Term. Options	Induct. (uH)	Rated Amps	Watts Loss	Dimensions (in.)			
	3% Z	2.4% Z	6% Z						Height	Width	Depth	Wgt
KLR2ATB	1	1	-	#12 Max	QD/FL/ST	11026	2	8	4.00	4.25	3.00	3
KLR3ATB	1.5	1.5-2	.5	#12 Max	QD/FL/ST	7351	3	9	4.00	4.25	3.00	3
KLR4ATB	2	3	.75	#12 Max	QD/FL/ST	5513	4	15	4.00	4.25	3.00	3
KLR6ATB	3	3	1-1.5	#12 Max	QD/FL/ST	3675	6	17	4.00	4.25	3.00	3
KLR8ATB	5	5	2	#12 Max	QD/FL/ST	2757	8	27	4.00	5.00	4.00	3
KLR12ATB	7.5	7.5-10	3	#12 Max	QD/FL/ST	1838	12	31	5.00	7.00	5.00	6
KLR16ATB	10	10	5	#4 - #18	FL/RL	1376	16	38	5.75	6.00	4.00	7
KLR18ATB	12	15	5	#4 - #18	FL/RL	1225	18	40	5.75	8.00	5.00	11
KLR21ATB	15	15	5	#4 - #18	FL/RL	1050	21	45	5.75	8.00	5.00	11
KLR25ATB	15	20	7.5	#4 - #18	FL/RL	882	25	48	5.75	8.00	5.00	11
KLR27ATB	20	25	7.5	#4 - #18	FL/RL	817	27	58	5.75	8.00	5.00	11
KLR35ATB	20-25	30	10	#4 - #18	FL/RL	630	35	70	5.75	8.00	5.00	14
KLR45ATB	30	40	15	#4 - #18	FL/RL	490	45	74	5.75	8.00	5.00	14
KLR55ATB	40	50	20	#1 - #18	FL/RL	401	55	113	7.00	9.00	6.00	22
KLR80ATB	50-60	60-75	25-30	#1 - #18	FL/RL	276	80	129	9.00	11.00	6.00	31
KLR110ACB	75	100	40	.28" hole	PT	200	110	152	9.00	11.00	7.00	39
KLR130ACB	100	125	50	.28" hole	PT	170	130	148	9.00	11.00	8.00	48
KLR160ACB	125	150	60	.34" hole	PT	130	160	165	9.00	11.00	8.00	50
KLR200ACB	150	200	75	.38" hole	PT	110	200	222	11.38	14.00	8.00	86
KLR250ACB	200	250	100	.44" hole	PT	88	250	261	11.38	14.00	8.00	91
KLR300ACB	250	300	100	.44" hole	PT	74	300	291	11.38	14.00	8.00	101
KLR360ACB	300	350	125-150	.56" hole	PT	61	360	380	11.38	14.00	8.00	90
KLR420ACB	350	400-450	150	.53" hole	PT	53	420	40	11.38	14.00	8.00	100
KLR480ACB	400	500	200	.53" hole	PT	46	480	392	11.38	15.00	11.00	115
KLR600ACB	450	625	250	.53" hole	PT	37	600	493	11.38	15.00	13.00	151
KLR750ACB	500	720	300	.53" hole	PT	29	750	515	17.25	16.94	10.25	283
KLR850ACB	750	800	350	.53" hole	PT	26	850	569	17.25	16.94	10.25	290
KLR950ACB	800	975	390	.53" hole	PT	23	950	686	17.25	16.94	10.25	295

Part Number	480V HP	240V HP	Conn. Type	Term. Options	Induct. (uH)	Rated Amps	Watts Loss	Dimensions (in.)			
	1.5% Z	3% Z						Height	Width	Depth	Wgt
KLR2BTB	1	-	#12 Max	QD/FL/ST	5513	2	4	4.00	5.00	4.00	3
KLR3BTB	1.5	0.5	#12 Max	QD/FL/ST	3667	3	5	4.00	5.00	4.00	3
KLR4BTB	2	0.75	#12 Max	QD/FL/ST	2757	4	9	4.00	5.00	4.00	3
KLR6BTB	3	1-1.5	#12 Max	QD/FL/ST	1836	6	9	4.00	5.00	4.00	3
KLR8BTB	5	2	#12 Max	QD/FL/ST	1378	8	14	4.00	5.00	4.00	3
KLR12BTB	7.5	3	#12 Max	QD/FL/ST	919	12	20	4.00	5.00	4.00	3
KLR16BTB	10	5	#4 - #18	FL/RL	689	16	20	5.00	6.00	4.00	7
KLR18BTB	12	5	#4 - #18	FL/RL	613	18	27	6.00	7.00	4.00	8
KLR21BTB	15	5	#4 - #18	FL/RL	525	21	30	6.00	7.00	4.00	8
KLR25BTB	15	7.5	#4 - #18	FL/RL	441	25	36	6.00	7.00	4.00	8
KLR27BTB	20	7.5	#4 - #18	FL/RL	408	27	43	6.00	7.00	4.00	8
KLR35BTB	20 - 25	10	#4 - #18	FL/RL	315	35	55	6.00	7.00	4.00	8
KLR45BTB	30	15	#4 - #18	FL/RL	245	45	59	6.00	7.00	4.00	8
KLR55BTB	40	20	#4 - #18	FL/RL	200	55	70	5.75	8.00	5.00	11
KLR80BTB	50 - 60	25-30	#1 - #18	FL/RL	138	80	105	7.00	9.00	6.00	22
KLR110BCB	75	40	.28" hole	PT	100	110	95	7.00	10.00	7.00	26
KLR130BCB	100	50	.28" hole	PT	85	130	117	9.00	11.00	7.00	33
KLR160BCB	125	60	.34" hole	PT	69	160	127	9.00	11.00	7.00	47
KLR200BCB	150	75	.38" hole	PT	55	200	135	9.00	11.00	7.00	53
KLR250BCB	200	100	.44" hole	PT	44	250	161	9.00	11.00	7.00	48
KLR300BCB	250	100	.44" hole	PT	37	300	216	9.00	11.00	9.00	54
KLR360BCB	300	125-150	.56" hole	PT	31	360	221	9.00	11.00	9.00	65
KLR420BCB	350	150	.53" hole	PT	26	420	275	11.38	14.00	8.00	85
KLR480BCB	400	200	.53" hole	PT	23	480	267	11.38	14.00	8.00	90
KLR600BCB	450	250	.53" hole	PT	18	600	338	11.38	14.00	8.00	96
KLR750BCB	500	300	.53" hole	PT	15	750	372	12.38	13.44	10.25	147
KLR850BCB	750	350	.53" hole	PT	13	850	389	12.38	13.44	10.25	150
KLR950BCB	800	390	.53" hole	PT	12	950	479	12.38	13.44	10.25	156

480 Volt 5% Z

Part Number	480V HP 5% Z	Conn. Type	Term. Options	Induct. (uH)	Rated Amps	Watts Loss	Dimensions (in.)		Wgt
							Height x Width x Depth		
KLR2CTB	1	#12 Max	QD/FL/ST	18377	2	11	4.00 x 5.00 x 4.00	3	
KLR3CTB	1.5	#12 Max	QD/FL/ST	12251	3	14	4.00 x 5.00 x 4.00	3	
KLR4CTB	2	#12 Max	QD/FL/ST	9189	4	23	4.00 x 5.00 x 4.00	3	
KLR6CTB	3	#12 Max	QD/FL/ST	6126	6	22	5.00 x 7.00 x 5.00	6	
KLR8CTB	5	#12 Max	QD/FL/ST	4594	8	34	5.00 x 7.00 x 5.00	6	
KLR12CTB	7.5	#12 Max	QD/FL/ST	3063	12	54	5.00 x 7.00 x 5.00	6	
KLR16CTB	10	#4 - #18	FL/RL	2297	16	58	5.75 x 8.00 x 5.00	12	
KLR18CTB	12	#4 - #18	FL/RL	2042	18	75	5.75 x 8.00 x 5.00	12	
KLR21CTB	15	#4 - #18	FL/RL	1750	21	59	5.75 x 8.00 x 5.00	14	
KLR25CTB	15	#4 - #18	FL/RL	1470	25	67	5.75 x 8.00 x 5.00	14	
KLR27CTB	20	#4 - #18	FL/RL	1361	27	80	5.75 x 8.00 x 5.00	14	
KLR35CTB	20 - 25	#1 - #18	FL/RL	1050	35	97	7.00 x 9.00 x 6.00	22	
KLR45CTB	30	#1 - #18	FL/RL	817	45	118	7.00 x 9.00 x 6.00	24	
KLR55CTB	40	#1 - #18	FL/RL	668	55	150	9.00 x 11.00 x 6.00	32	
KLR80CTB	50 - 60	#1 - #18	FL/RL	459	80	154	9.00 x 11.00 x 7.00	48	
KLR110CCB	75	.28" hole	PT	334	110	191	9.00 x 11.00 x 8.00	50	
KLR130CCB	100	.28" hole	PT	283	130	239	11.38 x 14.00 x 8.00	81	
KLR160CCB	125	.34" hole	PT	230	160	254	11.38 x 14.00 x 8.00	84	
KLR200CCB	150	.38" hole	PT	184	200	337	11.38 x 14.00 x 8.00	110	
KLR250CCB	200	.44" hole	PT	147	250	353	11.38 x 14.00 x 10.00	91	
KLR300CCB	250	.44" hole	PT	123	300	443	11.38 x 15.00 x 11.00	122	
KLR360CCB	300	.56" hole	PT	102	360	406	11.38 x 15.00 x 11.00	156	
KLR420CCB	350	.53" hole	PT	88	420	500	11.38 x 15.00 x 13.00	160	
KLR480CCB	400	.53" hole	PT	77	480	522	11.38 x 15.00 x 13.00	175	
KLR600CCB	450	.53" hole	PT	61	600	650	17.25 x 16.94 x 10.25	275	
KLR750CCB	500	.53" hole	PT	49	750	732	17.25 x 16.94 x 10.25	295	
KLR850CCB	750	.53" hole	PT	43	850	850	17.25 x 16.94 x 10.25	300	
KLR950CCB	800	.53" hole	PT	39	950	978	17.25 x 16.94 x 10.25	305	

575 Volt 3% Z

Part Number	575V HP 3% Z	Conn. Type	Term. Options	Induct. (uH)	Rated Amps	Watts Loss	Dimensions (in.)		Wgt
							Height x Width x Depth		
KLR2DTB	1	#12 Max	QD/FL/ST	13784	2	9	4.00 x 5.00 x 4.00	4	
KLR3DTB	1.5 - 2	#12 Max	QD/FL/ST	9189	3	12	4.00 x 5.00 x 4.00	4	
KLR4DTB	3	#12 Max	QD/FL/ST	6892	4	18	4.00 x 4.25 x 3.00	4	
KLR6DTB	3	#12 Max	QD/FL/ST	4595	6	22	4.00 x 5.00 x 4.00	5	
KLR8DTB	5	#12 Max	QD/FL/ST	3446	8	28	5.00 x 7.00 x 5.00	7	
KLR12DTB	7.5	#12 Max	QD/FL/ST	2297	12	44	5.00 x 7.00 x 5.00	7	
KLR16DTB	10	#4 - #18	FL/RL	1723	16	52	5.00 x 6.00 x 4.00	8	
KLR18DTB	15	#4 - #18	FL/RL	1532	18	44	5.75 x 8.00 x 5.00	12	
KLR21DTB	15	#4 - #18	FL/RL	1313	21	51	5.75 x 8.00 x 5.00	13	
KLR25DTB	20	#4 - #18	FL/RL	1103	25	72	5.75 x 8.00 x 5.00	13	
KLR27DTB	25	#4 - #18	FL/RL	1021	27	62	5.75 x 8.00 x 5.00	13	
KLR35DTB	30	#4 - #18	FL/RL	788	35	79	5.75 x 8.00 x 5.00	16	
KLR45DTB	40	#1 - #18	FL/RL	613	45	90	7.00 x 9.00 x 6.00	26	
KLR55DTB	50	#1 - #18	FL/RL	501	55	90	7.00 x 9.00 x 6.00	24	
KLR80DTB	60 - 75	#1 - #18	FL/RL	345	80	116	9.00 x 11.00 x 7.00	49	
KLR110DCB	100	.28" hole	PT	251	110	217	9.50 x 10.56 x 8.25	49	
KLR130DCB	125	.28" hole	PT	212	130	242	9.50 x 10.56 x 8.25	47	
KLR160DCB	150	.34" hole	PT	172	160	261	9.00 x 11.00 x 7.00	47	
KLR200DCB	200	.38" hole	PT	138	200	270	12.38 x 13.44 x 9.00	86	
KLR250DCB	250	.44" hole	PT	110	250	316	12.38 x 13.44 x 9.00	91	
KLR300DCB	300	.44" hole	PT	92	300	335	12.38 x 13.44 x 9.00	101	
KLR360DCB	350	.56" hole	PT	77	360	420	12.38 x 13.44 x 9.00	98	
KLR420DCB	400	.53" hole	PT	66	420	435	12.38 x 13.44 x 9.00	100	
KLR480DCB	500	.53" hole	PT	57	480	395	12.38 x 13.44 x 10.25	175	
KLR600DCB	600	.53" hole	PT	46	600	580	12.38 x 13.44 x 10.25	151	
KLR750DCB	700	.53" hole	PT	37	750	604	18.00 x 18.00 x 13.00	270	
KLR850DCB	800	.53" hole	PT	32	850	703	18.00 x 18.00 x 12.00	275	
KLR950DCB	900	.53" hole	PT	29	950	773	18.00 x 18.00 x 12.00	280	

575 Volt 5% Z

Part Number	575V HP 5% Z	Conn. Type	Term. Options	Induct. (uH)	Rated Amps	Watts Loss	Dimensions (in.)	
							Height x Width x Depth	Wgt
KLR2ETB	1	#12 Max	QD/FL/ST	22973	2	13	4.00 x 5.00 x 4.00	4
KLR3ETB	1.5 - 2	#12 Max	QD/FL/ST	15315	3	17	4.00 x 5.00 x 4.00	5
KLR4ETB	3	#12 Max	QD/FL/ST	11486	4	27	4.00 x 5.00 x 4.00	5
KLR6ETB	3	#12 Max	QD/FL/ST	7658	6	28	5.00 x 7.00 x 5.00	7
KLR8ETB	5	#12 Max	QD/FL/ST	5743	8	48	5.00 x 7.00 x 5.00	7
KLR12ETB	7.5	#12 Max	QD/FL/ST	3829	12	56	5.75 x 8.00 x 5.00	8
KLR16ETB	10	#4 - #18	FL/RL	2872	16	67	5.75 x 8.00 x 5.00	13
KLR18ETB	15	#4 - #18	FL/RL	2553	18	73	5.60 x 6.94 x 3.44	12
KLR21ETB	15	#4 - #18	FL/RL	2188	21	69	5.75 x 8.00 x 5.00	17
KLR25ETB	20	#1 - #18	FL/RL	1838	25	92	7.00 x 9.00 x 6.00	17
KLR27ETB	25	#1 - #18	FL/RL	1702	27	94	7.00 x 9.00 x 6.00	17
KLR35ETB	30	#1 - #18	FL/RL	1313	35	125	7.00 x 9.00 x 6.00	23
KLR45ETB	40	#1 - #18	FL/RL	1021	45	146	7.00 x 9.00 x 7.00	26
KLR55ETB	50	#1 - #18	FL/RL	835	55	132	7.00 x 10.00 x 7.00	33
KLR80ETB	60 - 75	#1 - #18	FL/RL	574	80	178	9.00 x 11.00 x 7.00	49
KLR110ECB	100	.28" hole	PT	418	110	259	8.50 x 14.00 x 8.00	53
KLR130ECB	125	.28" hole	PT	353	130	287	11.38 x 14.00 x 8.00	88
KLR160ECB	150	.34" hole	PT	287	160	299	11.38 x 14.00 x 8.00	95
KLR200ECB	200	.38" hole	PT	230	200	349	11.38 x 14.00 x 9.00	110
KLR250ECB	250	.44" hole	PT	184	250	375	11.38 x 14.00 x 9.00	115
KLR300ECB	300	.44" hole	PT	153	300	422	11.38 x 15.00 x 11.00	122
KLR360ECB	350	.56" hole	PT	128	360	463	11.38 x 15.00 x 11.00	156
KLR420ECB	400	.53" hole	PT	109	420	532	11.38 x 15.00 x 11.00	160
KLR480ECB	500	.53" hole	PT	96	480	576	11.38 x 15.00 x 11.00	175
KLR600ECB	600	.53" hole	PT	77	600	782	17.25 x 16.94 x 10.25	275
KLR750ECB	700	.62" hole	PT	61	750	929	18.00 x 18.00 x 13.00	260
KLR850ECB	800	.62" hole	PT	54	850	1007	18.00 x 18.00 x 12.00	290
KLR950ECB	900	.62" hole	PT	48	950	1100	18.00 x 18.00 x 12.00	290

Termination Options

Termination Options	Type	AMP Range	Connection Type
TB	Terminal Block	2 - 80 (std.)	#4 - #18
QD	Quick Disconnect	2 - 12	1/4" Female Faston
ST	Screw Terminal	2 - 12	#6 (Supplied)
FL	Flying Lead	2 - 80	2' Std; 2-18# Leads
RL	Ring Lugs	16 - 80	.25 - .38 Bolt
CB	Copper Bus	110 - 950 (std.)	.25 - .50 Bolt
PT	Pressure Terminal	110 - 950	.25 - .50 Bolt*

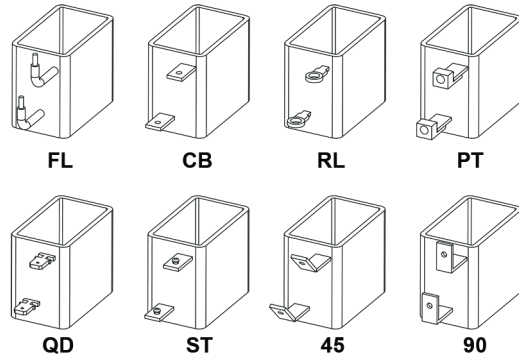

* 1, 2 or 3 conductors per phase.

KLR Enclosures

NEMA 1 Enclosures	*Part Number	KLR Suffix	Dimensions (in.)
	C1	1	6.50 x 8.00 x 6.00
	C2	2	7.50 x 10.00 x 7.00
	C3	3	9.00 x 12.00 x 8.00
	C4	4	15.50 x 15.00 x 13.00
	C5	5	18.50 x 20.00 x 16.00
	C7	7	36.00 x 28.50 x 30.30

* Enclosures are sized on the standard product designs. When adding an option, such as pressure terminals (PT), enclosure sizes are subject to change.

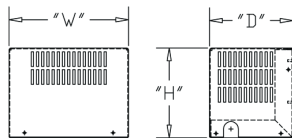

Cabinet representation - C1, C2

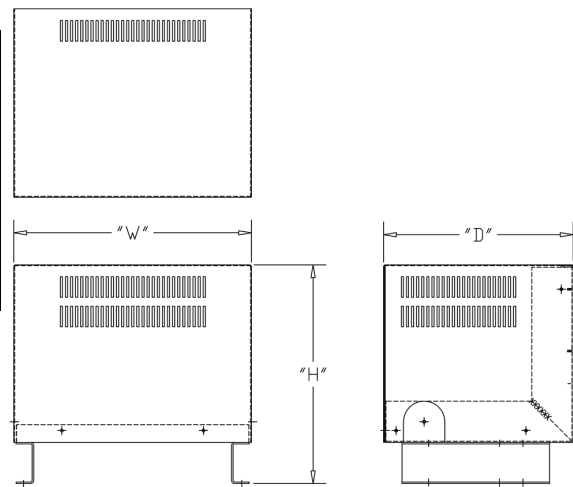

Cabinet representation - C3 through C5

KLR Series Three Phase Reactors

The industry-standard three phase reactor for drives

Characteristics

Impedance Protection:	2.4 to 3% eliminates bus overvoltage tripping 5 to 6% protects against physical damage to most drive components and offers harmonic reduction without added capacitance 1.5% is the recommended input minimum
System Voltage:	208/240 VAC, 480 VAC, 575/600 VAC, 690 VAC
Insulation System:	Class H (180° C) or Class R (220° C)
Temperature Rise:	115° C or 155° C
Ambient Temperature:	40° C
Altitude (Maximum):	1000 meters (Derating necessary above 1000 meters)
Fundamental Frequency:	60 hz
Short Term Overload Rating:	Tolerate 200% rated I for a minimum of 3 minutes
Agency Approvals:	CE Marked, UL and CUL Recognized
Inductance Characteristics:	Minimum 95%L at 110% Load Minimum 80%L at 150% Load
Input and Output:	Applicable on either the line or load side of a PWM drive
Inductance:	Distributed Gap Technology™
Enclosures:	Open, UL Type 1 and UL Type 3R enclosures available
Harmonics Reduction:	KLR Three Phase Reactors will reduce RMS current through the reduction in harmonic content, thereby improving the total power factor
Input Voltage Unbalance:	KLR Three Phase Reactor to the input of every drive will help balance the drive input line currents

KLRUL Reactors

All KLR Series Three Phase Reactors are UL component recognized. KLR Reactors are also available as UL Listed products. UL Type 1 and UL Type 3R enclosures are available for UL Listed Reactors. The enclosure you select for your reactor will depend on two things: the degree of protection the reactor must have against indoor and outdoor environments as well as the certification requirements of the installation. TCI offers NEMA 1 enclosures, UL Type 1 and UL Type 3R enclosures.

