

QIT600F3

User Manual

Important Reminders

1. This product is suitable for general applications, such as handwritten editing of document and viewing of multimedia contents, please use this equipment indoors.
2. Please use the accessories supplied in the package. Our company does not provide free support for damage caused by the accessories not certified by QOMO.
3. Do not touch the power cord with force or wet object, to avoid electric shock or fire.
4. Use properly grounded plugs and sockets, to avoid electric shock and equipment damage.
5. Do not place any flammable or explosive items such as candles, insecticides or cigarettes near this product.
6. Do not allow any heating device to be near the power cord, the aging of jacket may result in electric shock or fire.
7. Do not install this product in a poorly ventilated place such as a bookcase or a wall cabinet, because the high temperature may cause a fire.
8. Do not use a non-standard display holder, to avoid injury.
9. Do not spray liquid such as detergent directly onto the display, to avoid damage, electric shock or fire.
10. Unplug the power cord before cleaning the product.
11. Do not open the back cover to avoid electric shock or fire. This product can only be repaired by a agent authorized by QOMO.
12. Do not place this product in a place with oil, smoke or moisture, or install it on the vehicle, to avoid failure, electric shock or fire.
13. Please remove the power cord during storms or lightning, or if it is not used for a long period.
14. If the display has been used for a long time, black or uneven spots may appear on its surface. This is a normal aging phenomenon. Please turn off the display periodically to extend its working life.

Contents

Chapter 1: Product Information.....	4
1-1. Product Introduction.....	4
1-2. Part Name and Function Introduction.....	5
Chapter 2: Use of tablet.....	7
2-1. Start/Shutdown.....	7
2-2. Tablet Setting.....	7
Chapter 3: Passive Handwriting Pen.....	12
3-1. Introduction of Passive Pen.....	13
3-2. Driver Installation (For MAC).....	13
3-3. Personalized Setting of Driver.....	14
3-4. Introduction to Driver Interface.....	15
3-5. Pen Button Setting.....	15
3-6. Pressure Sensitivity setting.....	16
3-7. Calibration.....	16
3-8. Driver Uninstallation.....	16
Chapter 4. References.....	17
4-1. Use of USB Extension Port (Universal Serial Bus).....	17
Product Specifications.....	18

Chapter 1: Product Information

1-1. Product Introduction

The tablet combines the technical advantages of the LCD screen and the electromagnetic handwriting input, to write on the screen in a free and simple way and thus improve working efficiency. The products are widely used in medical treatment, business meetings, multimedia teaching and other related fields.

Product Features:

1. 21.5 Inch IPS LCD screen;
2. 1920*1080 FHD display;
3. Handwriting or passive pen writing;
4. 8192 level handwriting pressure sensitivity;
5. Support HDMI input or output;
6. USB 3.0 ports extension;
7. Compatible system Win 7,8,10, chrome OS, MAC

1-2. Part Name and Function Introduction

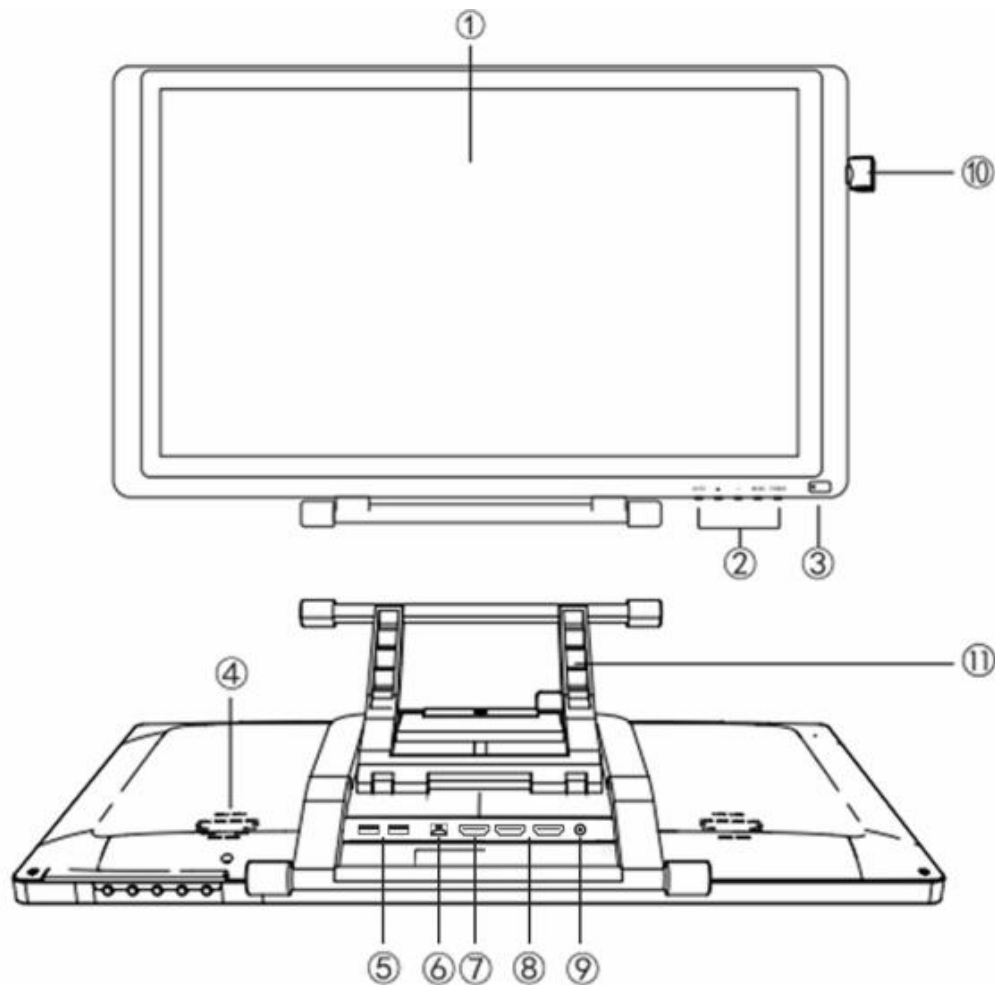

Part No.	Part name	Function description
①	Display screen	Screen display area / electromagnetic handwriting area
②	Function buttons	Power on/off key: Press and hold to turn on / off the tablet Touch on/off: Turn capacitive touch on/off
③	Indicator light	Green: Working mode Red: Standby mode
④	Speaker	Stereo Audio
⑤	USB	2*USB 3.0 extension port (working current: <1A)
⑥	Touch	Touch input
⑦	HDMI in	HDMI input
⑧	HDMI out	2 HDMI outputs-for sharing on multiple screen
⑨	Power input	Power input
⑩	Pen holder	For handwriting pen
⑪	Stand	Adjustable stand

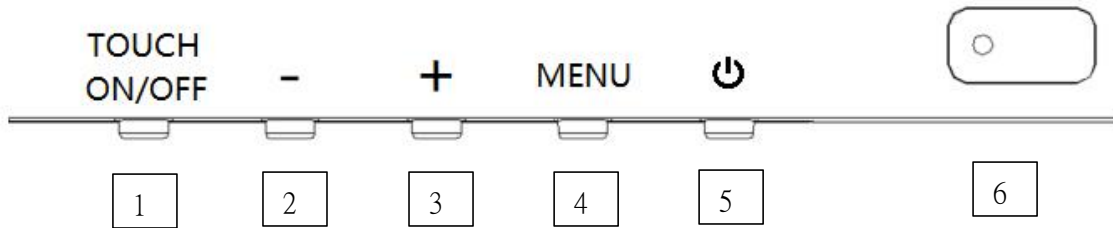

1	Turn on/off touch/Back	4	Menu
2	Volume/Down adjust	5	Power on/off
3	Volume/Up adjust	6	Power Indicator

1-3. Product Installation

1-3-1. Connection process

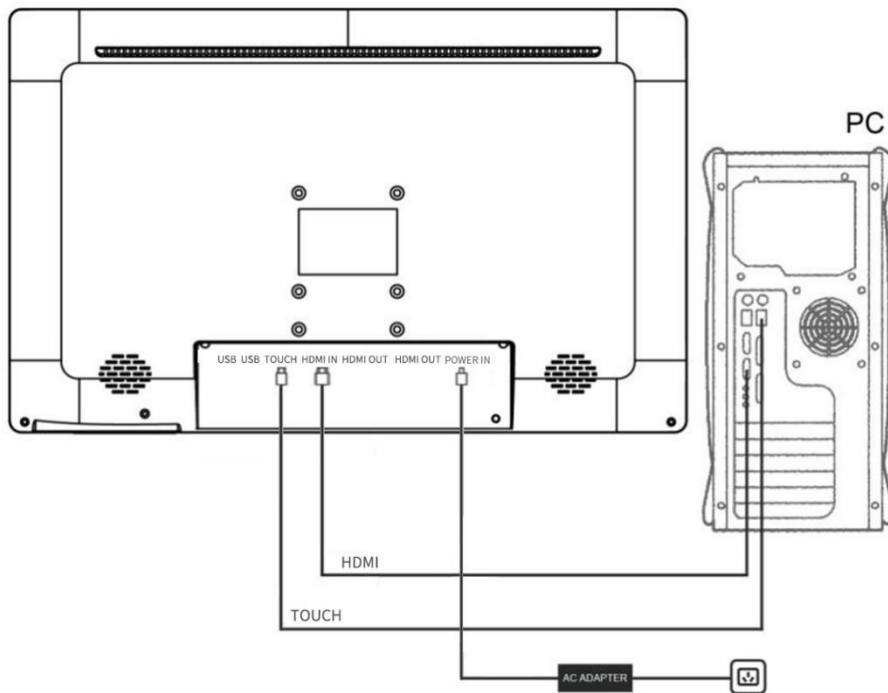

- ① Connect the computer to the HDMI IN port on the tablet using an HDMI cable.
- ② Next enable touch control by connecting the computer to the touch port using a USB A-B cable. The USB Type-B (square port) connects to the tablet.

- ③ To share the monitor screen to large format displays and projectors, connect the HDMI-OUT ports on the tablet to the HDMI-IN ports on your desired displays.
- ④ Connect the power adapter to the tablet and plug into a wall port to turn the tablet on.
- ⑤ Use the USB extender ports to connect a mouse, keyboard, or thumb drives.

Chapter 2: Use of tablet

2-1. Start/Shutdown

1. Press and hold the “Power” button for 1 second to start the tablet, the LED light will be green
2. Press and hold the “Power” button for 1 second to shut off the tablet, the LED indicator will be also turned off.
3. Menu: To enter Menu setting. When it is in the Menu interface, this is a confirm button.
5. Volume setting: Press -/+ to set volume value.
6. Touch on/off: Press Touch ON/OFF to turn on/off the touch. It is also a back button.

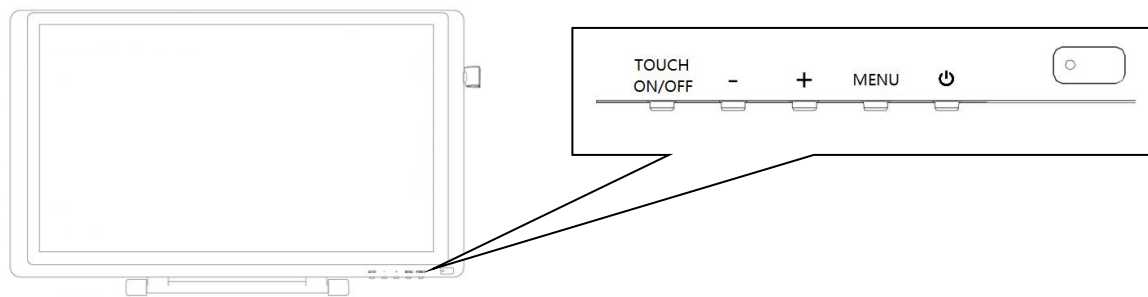

2-2. Tablet Setting

Picture setting

1. Brightness setting: Continuously press “MENU” button for three times to enter brightness setting page. Press “+” and “-” buttons to adjust the brightness of screen, press “MENU” button to confirm, and press “TOUCH” button to exit the menu.

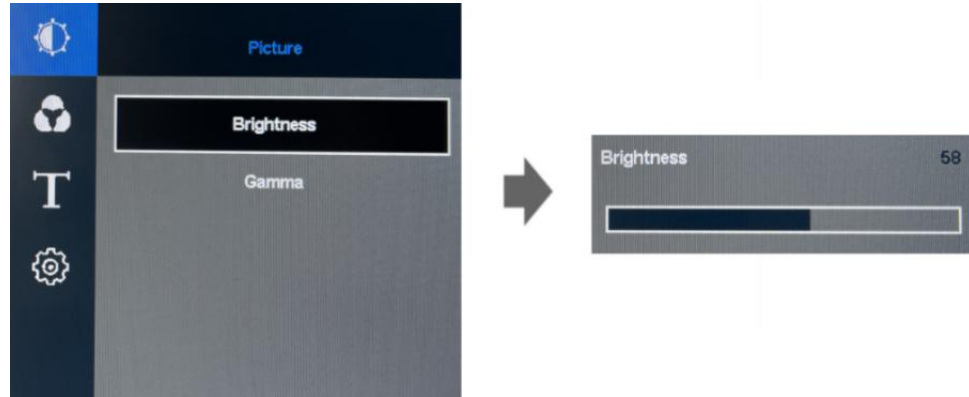

2. Gamma setting: Continuously press “MENU” for two times to enter picture setting page. Press “+” and “-” buttons to set gamma value, press MENU to confirm, and press “TOUCH” button to exit the menu.



Color setting

1. **Color temperature setting:** Press “MENU” button to enter menu page, press “+” button to move the cursor to the color interface, press “MENU” button twice to enter color adjustment interface. Press “+” and “-” buttons to select the corresponding color temperature parameter. Press “MENU” button to confirm, and press “TOUCH” button to exit the menu.

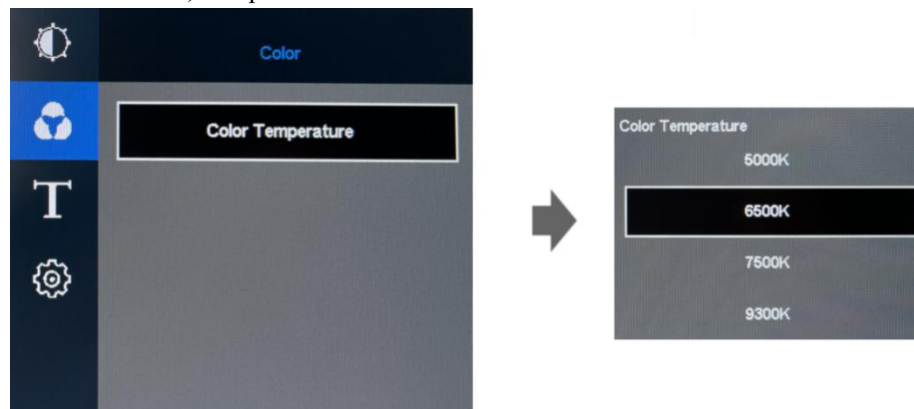

2. **Custom setting of color:** Press “MENU” button to enter menu page, press “+” button to move the cursor to the color interface, press “MENU” button twice to enter color setting interface. Press “+” button to move to the user and press “MENU” button to enter user interface. Press “+” and “-” buttons to move the the cursor to select the color type, and press “MENU” button to enter adjustment. Press “+” and “-” buttons to adjust the parameters, press “MENU” button to confirm, and press “TOUCH” button to exit the menu.

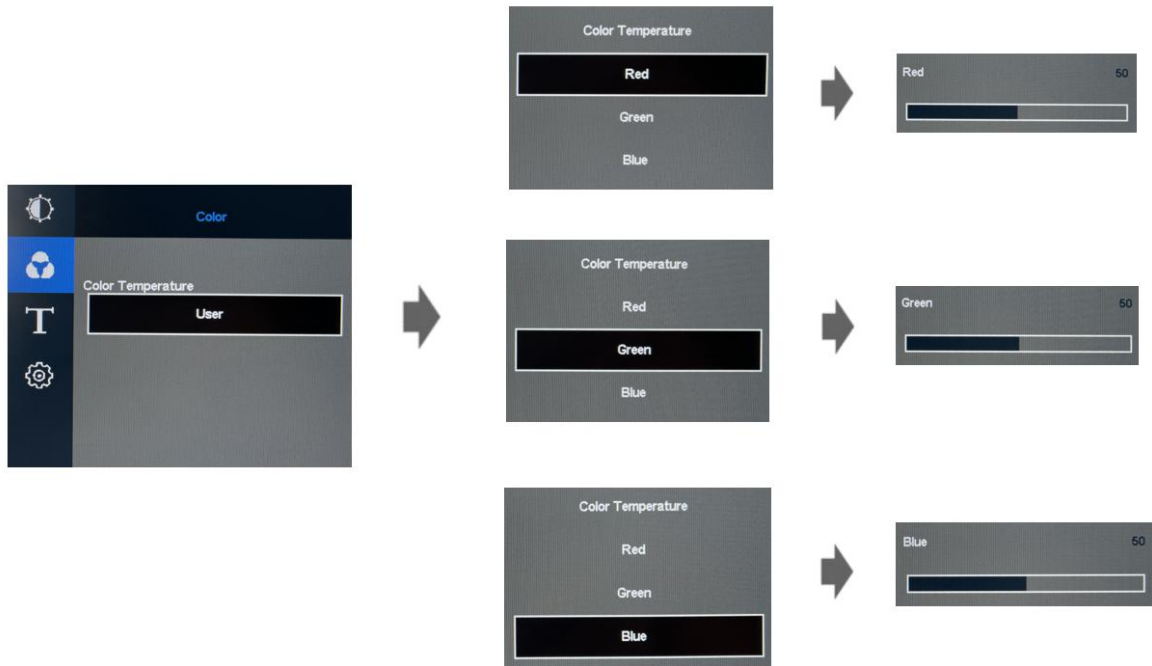

Menu Setting

1. **Horizontal setting:** Press “MENU” button to enter menu, press “+” button to move the cursor to the menu interface, and press “MENU” button twice to enter horizontal position adjustment interface. Press “+” and “-” buttons to adjust the horizontal position of OSD menu, press “MENU” button to confirm, and press “TOUCH” button to exit the menu.

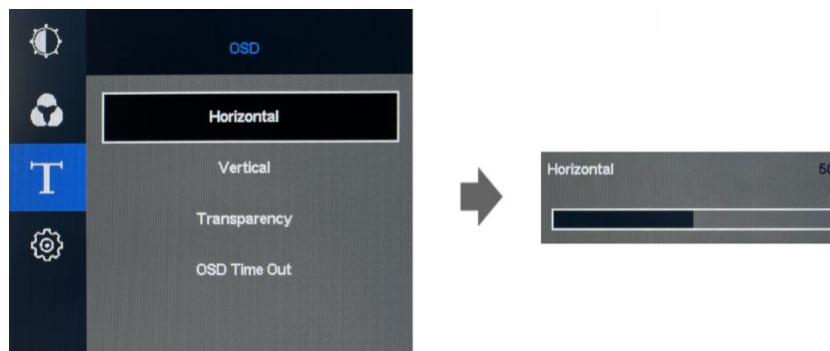

2. **Vertical setting:** Press “MENU” button to enter menu, press “+” button to move the cursor to the menu interface, and press “MENU” button to enter menu adjustment interface. Press “+” button

to move the cursor to the vertical position, and press “MENU” button to enter vertical position adjustment interface. Press “+” and “-” buttons to adjust the vertical position of OSD menu, press “MENU” button to confirm, and press “TOUCH” button to exit the menu.

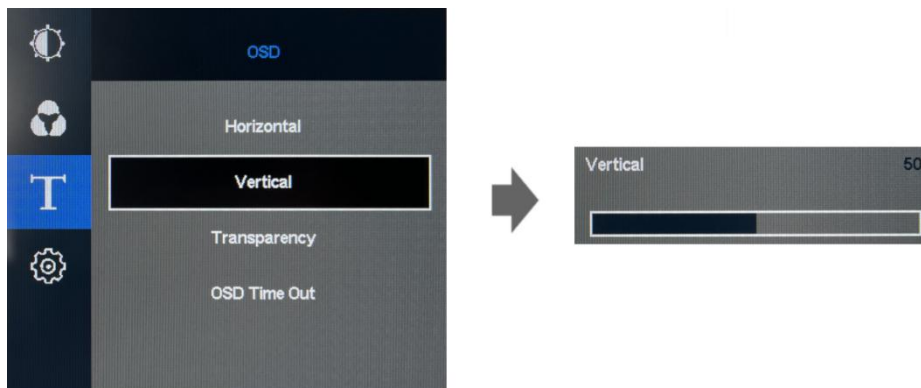

3. **Transparency setting:** Press “MENU” button to enter menu, press “+” button to move the cursor to the menu interface, and press “MENU” button to enter menu adjustment interface. Press “+” button to move the cursor to transparency, and press “MENU” button to enter transparency adjustment interface. Press “+” and “-” buttons to adjust the display transparency parameters of OSD menu, press “MENU” button to confirm, and press “TOUCH” button to exit the menu.

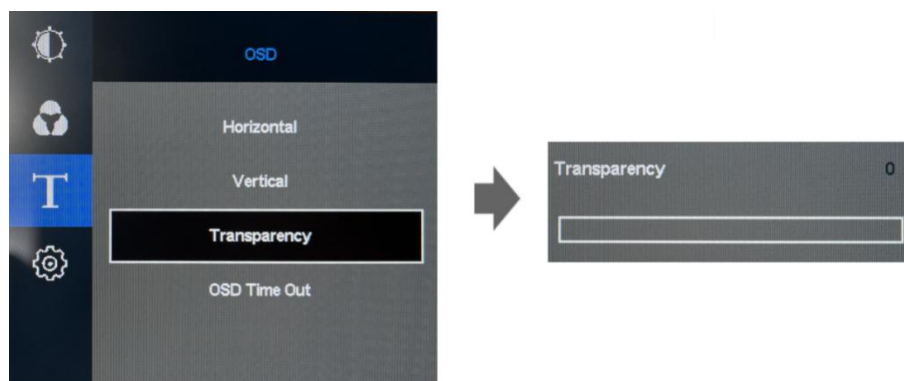

4. **Time setting:** Press “MENU” button to enter menu, press “+” button to move the cursor to the menu interface, and press “MENU” button to enter menu adjustment interface. Press “+” button to move the cursor to display time, and press “MENU” button to enter display time adjustment interface. Press “+” and “-” buttons to adjust the display retention time of OSD menu, press “MENU” button to confirm, and press “TOUCH” button to exit the menu.

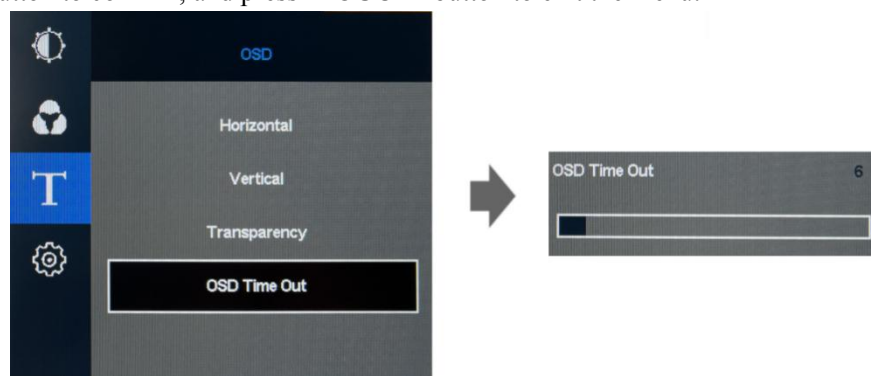

System Setting

1. **Language setting:** Press “MENU” button to enter menu, press “+” button to move the cursor to the setting interface, and press “MENU” button twice to enter language adjustment interface. Press “+” and “-” buttons to select the required language, press “MENU” button to confirm, and press “TOUCH” button to exit the menu.

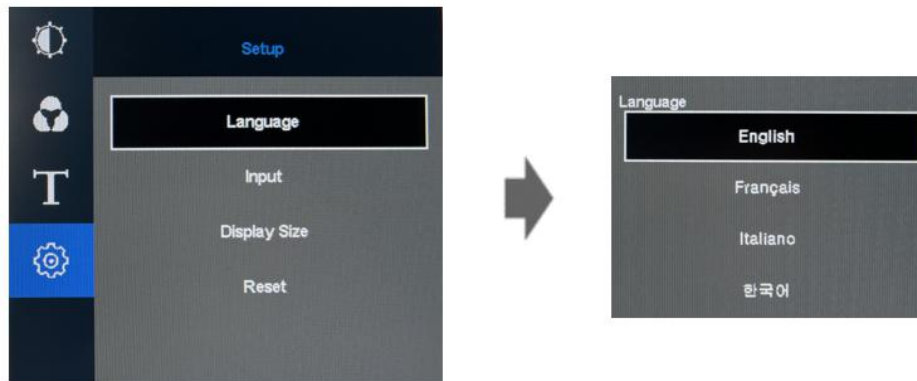

2. **Input way setting:** Press “MENU” button to enter menu, press “+” button to move the cursor to the setting interface, and press “MENU” button to enter the setting interface. Press “+” button to move to input signal, and press “MENU” button to enter input signal interface. Press “+” and “-” buttons to move the cursor to select the input signal (Type-C/HDMI), press “MENU” button to confirm, and press “TOUCH” button to exit the menu.



4. **Display size setting:** Press “MENU” button to enter menu, press “+” button to move the cursor to the setting interface, and press “MENU” button to enter the setting interface. Press “+” button to move to display size, and press “MENU” button to enter display size adjustment interface. Press “+” button to select size (full screen or 4:3), press “MENU” button to confirm, and press “TOUCH” button to exit the menu.

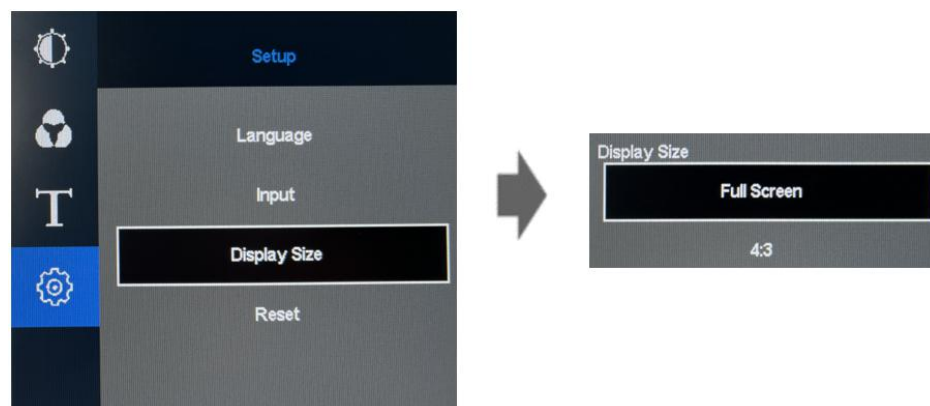

5. Reset setting

Press “MENU” button to enter the menu, press “+” button to move the cursor to the setting interface, and press “MENU” button to enter the setting interface. Press “+” button to move to reset, press “MENU” button to confirm, and press “TOUCH” button to exit the menu.

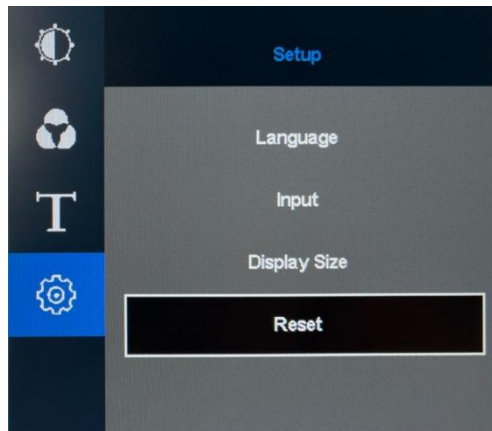

Chapter 3: Passive Handwriting Pen

This chapter guide you how to operate your computer and software by using a handwriting pen. You can input information to the computer through the passive pen, to realize the writing function and operate the computer.

3-1. Introduction of Passive Pen

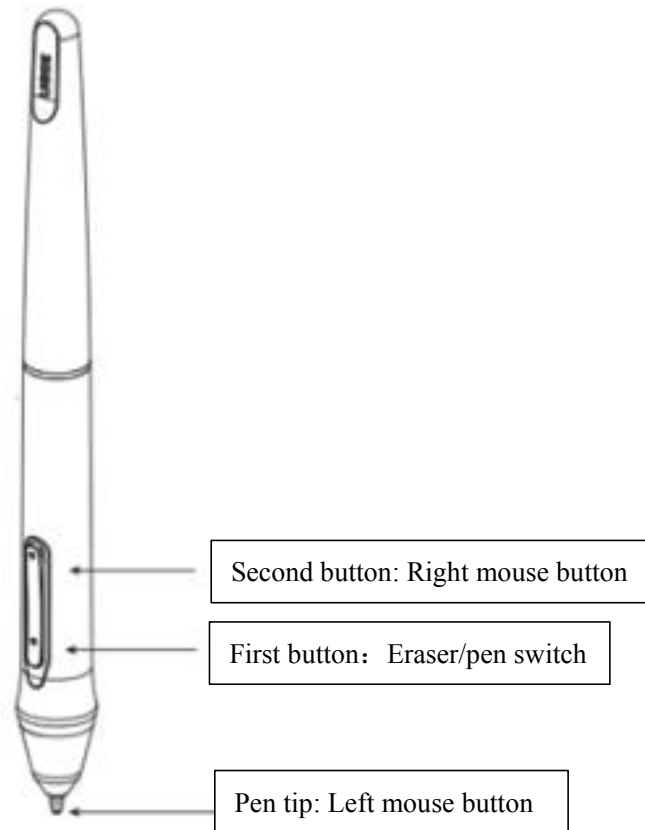

Remarks:

- ① The functions of the first and second buttons can be set by the user;
- ② Do not disassemble or assemble the electromagnetic pen in any way;

Replacement of Refill

1. Use a pen extractor to remove the refill from the pen tip. Insert the refill into the pen and press it tightly



3-2. Driver Installation (For MAC)

1. Precautions before installation:

Only MAC OS requires a driver to be installed. Uninstall the programs related to the tablet and restarting the computer. Turn off anti-virus software, firewall or other security software to avoid conflicts. Then install the driver.

2. Open the driver file that downloaded (the suffix is .dmg), there will be a disk image called “PenTablet” on the desktop. Open the document file, the PenTabletSetting installation will show. Drag the file “PenTablet” to Application, the installation will be done. After doing it, you will see the PenTabletSetting shows on your Application list.

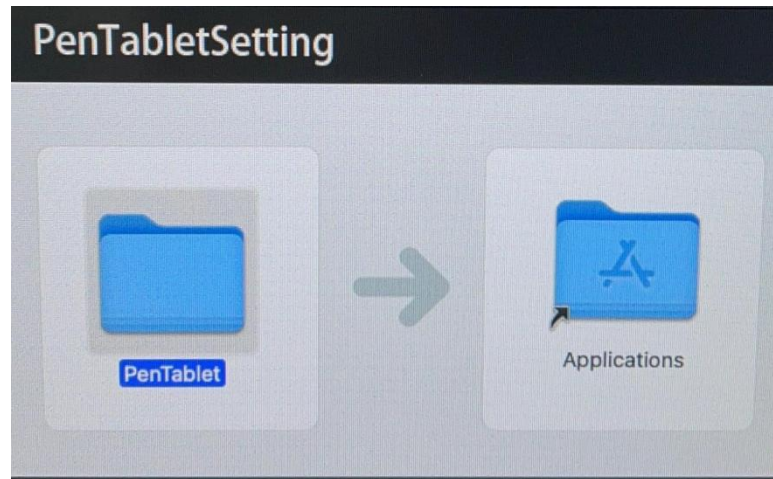

3-3. Personalized Setting of Driver

1. After the driver has been installed, the normal function will fulfill most requirement you need. If you need further personalized setting, you can set in the driver panel.
2. Run the driver, go to setting page to set the pen button function.
3. After opening the setting page, press the screen with pen tip. If there is data shows [Current Pressure], means all function works.
4. When the pen pressure is normal, you can open the writing software and start writing.

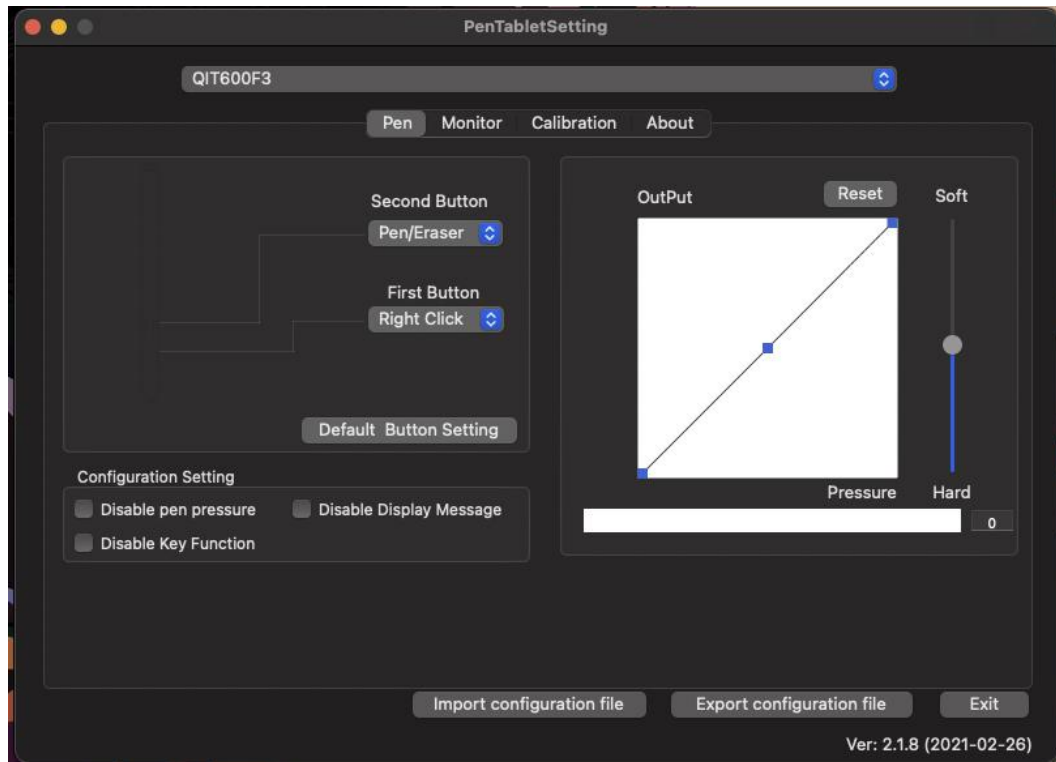

3-4. Introduction to Driver Interface

There are 4 menus in driver control panel, including: Pen, Monitor, Calibration.

1. Pen: To set the basic functions of handwriting pen and the custom functions of pen buttons;
2. Monitor: Monitor mapping;
3. Calibration: Click this menu to enter the screen calibration interface.
4. About: Shows software version

3-5. Pen Button Setting

Set the button function of pen. It can completely replace the mouse when it is working.

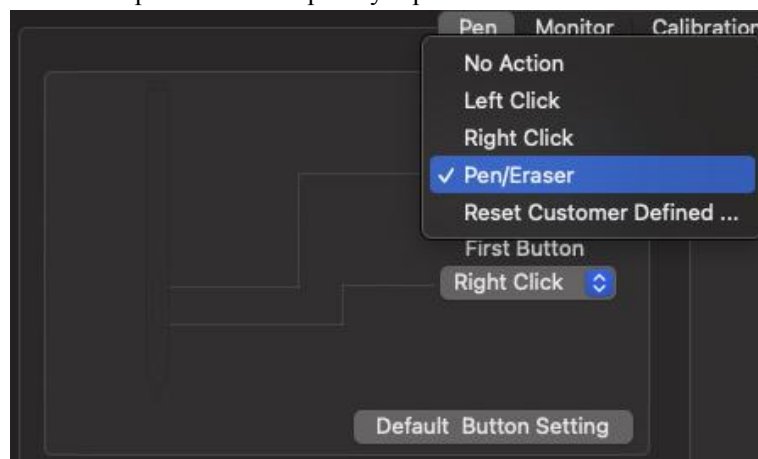

3-6. Pressure Sensitivity setting

Pressure sensitivity setting: Press the screen with pen tip. If there is data shows [Current Pressure], means all function works.

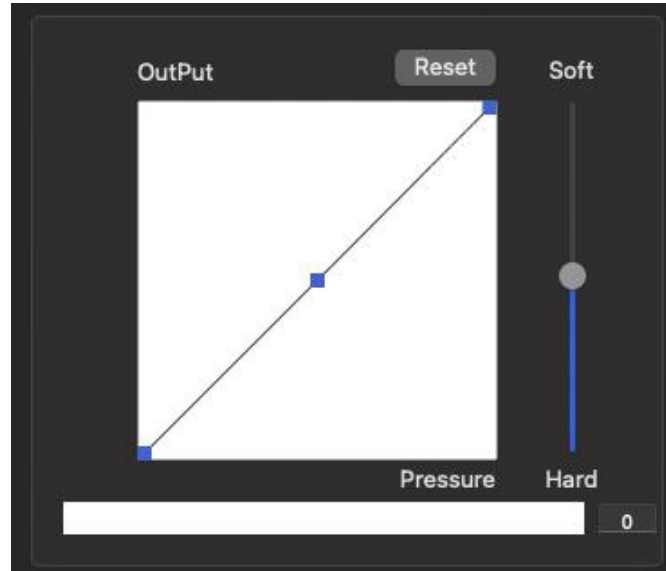

3-7. Calibration

Screen calibration: It is used to adjust the deviation of handwriting pen.

Go to the “Calibration Page”, and using the pen tip to click the red dots on the calibration page in turn to complete calibration.

3-8. Driver Uninstallation

For Mac system: Open [Finder] → [Applications] → [PenTablet] → open [UninstallPenTablet] →click [Uninstall] to confirm uninstallation. Follow the guide until the program has been uninstalled and restart the computer.

Chapter IV: Troubleshooting

	Fault	Solution
Handwriting Problems	Unable to control cursor	<ol style="list-style-type: none"> 1. Check if the tablet displays the images normally 2. Restart the tablet.
	To verify the driver was installed successfully	After the driver has been installed, the driver icon  will list in the launchpad. Run the driver and check whether the pen pressure is normal.
	Unable to identify pen pressure	<ol style="list-style-type: none"> 1. Make sure that the software supports the pen pressure function. 2. For MAC: Download the latest driver package from our official website, check whether the pen pressure is normal.

Display Problems	No image shows: 1.The power indicator light is not on. 2.The power indicator light is red.	1.Turn on the tablet. If still no image, turn off the power and turn on again after a few minutes. 2. Try to connect the input signal
	“No Signal” tip shows	This tip will appear when there is no signal input even if the display is working properly. The following steps need to be checked: 1.Whether the computer has been turned on 2.Whether the signal cable is connected properly 3.Switch the input signal 4.Turn off the power and turn it on again
	The screen is too bright or too dark	Set“Brightness” and “Contrast” in the setup menu (refers to “Color setting”).(The backlight of LCD screen has a certain life time. If the screen dims or flicker, please contact support)
	There are green/red/blue/white or dark dots on the screen	This is a nature of LCD panel, not a fault.
	Fringes appear on screen, and cannot be removed by pressing.	Try to display a whole white or black image on the screen
Other Problems	No sound	Check if USB-Type B is properly connected to the computer Check if the computer volume is set to “0” Check the settings of computer and the software used to play audio files
	The unit that connects by USB does not work	Check whether the USB cable is properly connected Connect it to other USB ports on the computer Restart the computer Check if the computer and operating system are compatible with USB Update to the latest USB 3.0 driver Contact QOMO support if above ways can not solve your problem

Chapter 4. References

4-1. Use of USB Extension Port (Universal Serial Bus)

There is a USB hub built in the product. The expansion port can be connected to the peripheral by connecting to the computer that compatible with USB.

This product is compatible with USB 3.0. High-speed data communication can be achieved by connecting to the peripheral compatible with USB 3.0 (only when the USB cable supports USB 3.0).

Required System Environment:

Computer and USB port

USB3.0 cable

Notes:

- The USB expansion device may not work properly. This is related to your computer, operating system, and peripherals. Please contact the USB expansion device manufacturer for a compatible usage plan.
- The equipment connected to the USB downstream port will be running even if the monitor is in a power saving mode. Therefore, even in the power saving mode, the power consumption of tablet may change depending on the connected device.
- The device connected to the USB downstream port does not work when the main power is disconnected.

Connection Method

1. Connect it with the power cord of computer and tablet respectively to ensure power supplying.
2. Connect the computer with the tablet by USB cable, and the system will automatically set the functions of USB hub.
3. Connect a peripheral compatible with USB to the USB downstream port of tablet.

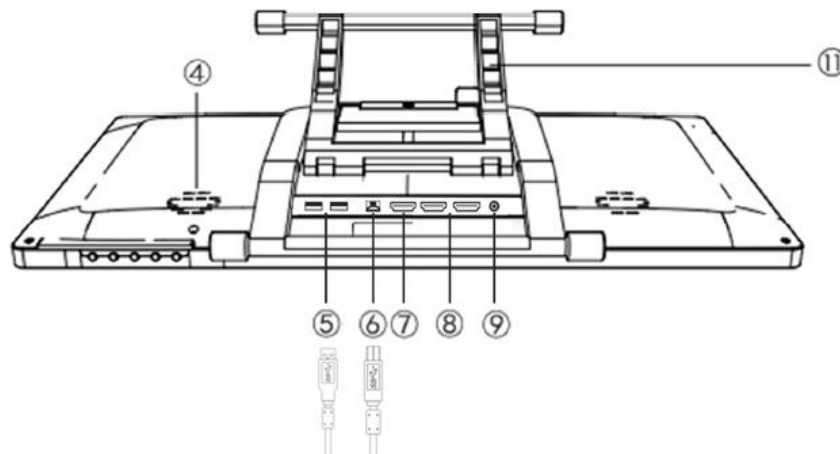

Product Specifications

Display Specification	
Product Name	QIT600F3 Capacitive Tablet Monitor
External Dimension	517 x 321.8 x 30 mm (without stent)
Display area(mm)	476.64 x 268.11 mm
Resolution	1920 x 1080
Response Time	14 ms
Pixel Size	0.24825 (H) x 0.24825 (V) mm
Signal interface	Dual channel LVDS
Color Support	16.7 M
Contrast Ratio	1000:1

Backlight unit	Lower side 1-LED Light bar Type
Brightness	250cd/m ²
View Angle	-89°~89° (H) , -89°~89° (V)
Operation Temperature	0°C~50°C
Storing Temperature	-20°C~60°C
Power Consumption	18.49W (MAX)
Input Power	AC100~240V Universal
Connection	DC power in x1; HDMI IN x1; HDIM OUT x2, USB3.0 TYPE B x 1 USB3.0 TYPE A x2 (Host)
Handwriting Specification	
Handwriting Technology	Electro magnetic
Active Area	476.64mm x 268.11mm
Stylus	Passive Pen PA2
Pressure Sensitivity	8192 Level
Reading Resolution	5080LPI
Accuracy	0.25mm
Reading Height	15mm (Max)
Report Rate	220RPS
Capacitive Touch Specification	
Active Area	476.64mm x 268.11mm
Surface hardness	≥7H
Structures	G+G
Cover Glass	1.8mm AG surface
Number of touch point	10 point
Total Transmittance	≥85%