

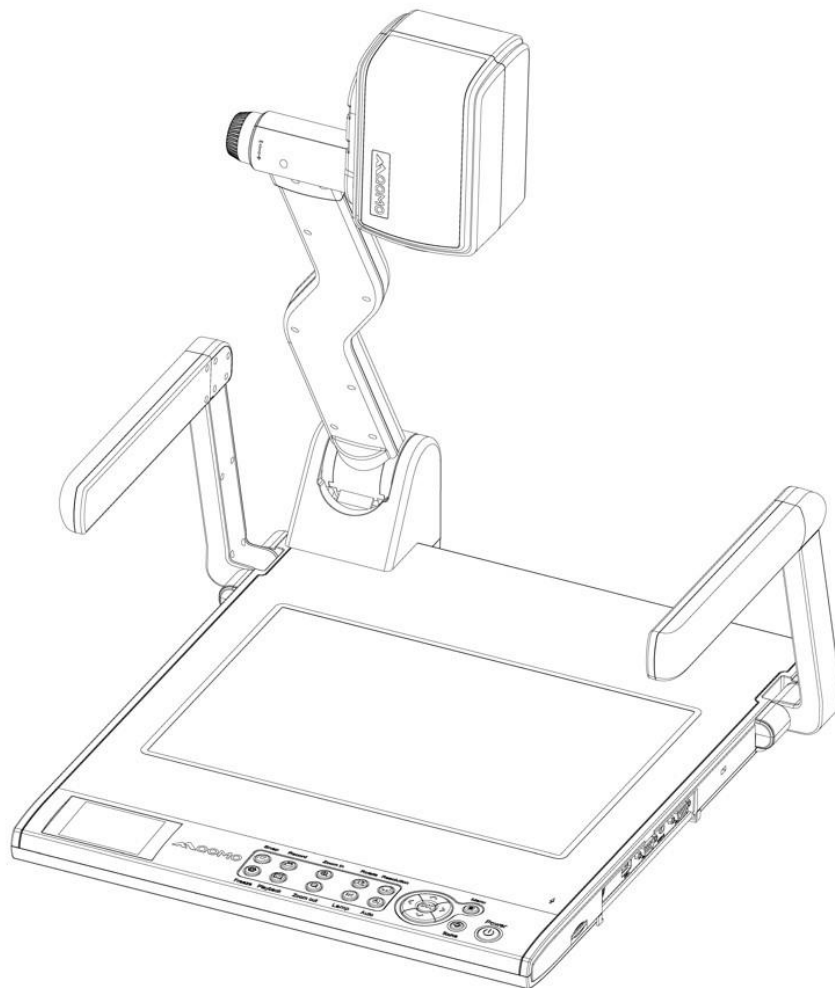

QD5000 4K UHD Visualizer

User Manual



Contents

Precautions	1
Parts Identification	2
Control Panel	3
Remote Control	4
Basic Preparations	5
Making Connections	6
Mouse Operating Instructions	8
Menu Operating Instructions	9
Basic Operation.....	10
RS232 code list	14
Folding The Unit.....	15
Problems And Solutions.....	16
Specifications.....	17

Precautions

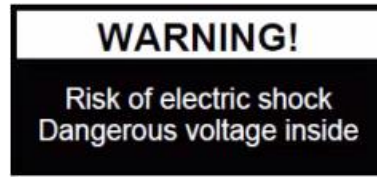

Please follow these precautions:

- To prevent fire or shock hazards, do not expose the unit to rain or moisture.
- To prevent electrical shock, do not open the cabinet. Refer to qualified personnel for service only.
- Do not use the unit continuously for more than 24 hours with camera autofocus on. It may cause damage to the camera lens.
- Be careful not to spill water or other liquids onto the unit, or allow combustible or metallic objects to get inside the cabinet.
- Unplug the visualizer from the wall outlet when it is not in use for an extended period.
- Clean the cabinet with a soft cloth lightly moistened with a mild detergent. Clean the lens carefully with an air spray or soft dry cloth to avoid scratching. When lamps flash or become dark, they should be replaced with new ones. Avoid interchanging arm lamps and bottom lamps frequently.

Parts Identification

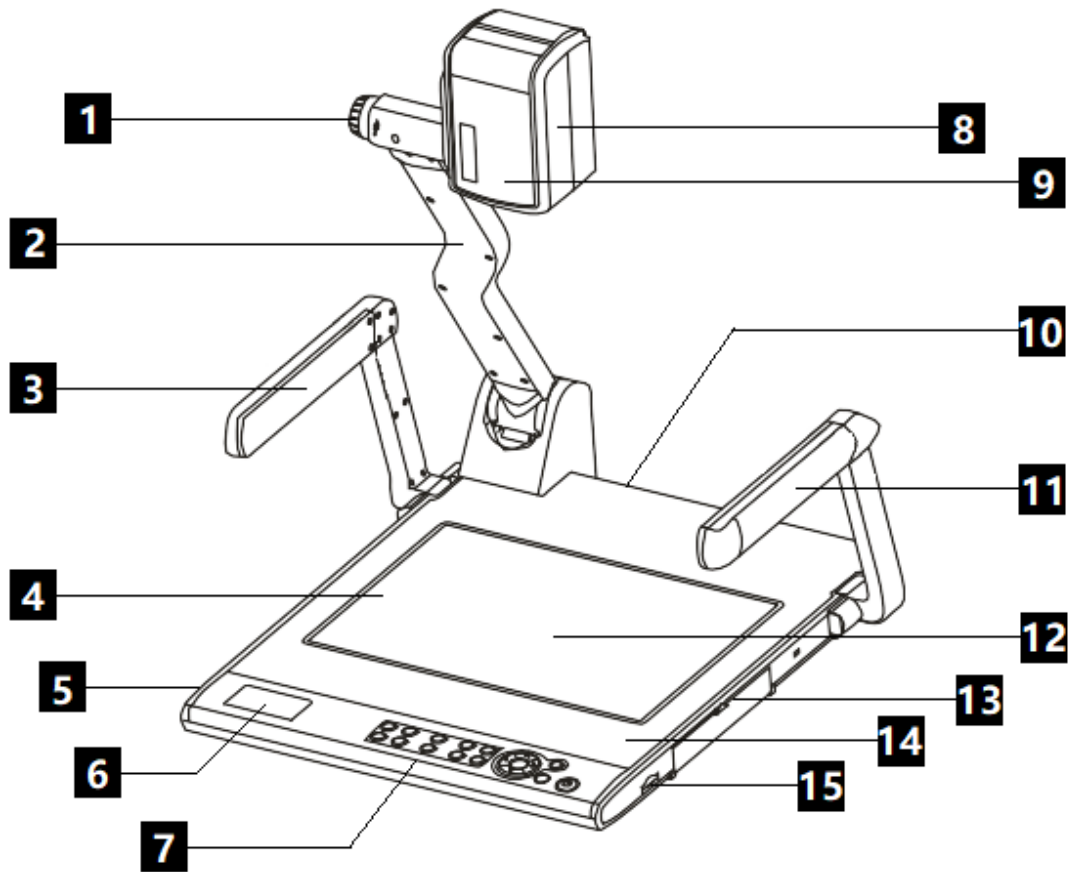





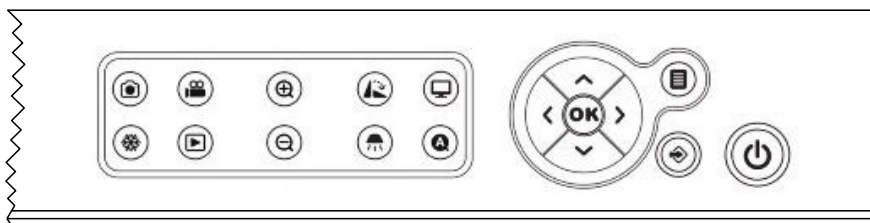













- | | |
|--------------------------|--------------------------|
| 1. Zoom in/Zoom out Knob | 9. Infrared Receive Area |
| 2. Camera Stand | 10. Rear Connector |
| 3. Left Arm Lamp | 11. Right Arm Lamp |
| 4. Bottom Lamp | 12. Work Stage |
| 5. Remote Control Slot | 13. Side Connector |
| 6. Preview screen | 14. Built-in Microphone |
| 7. Control Panel | 15. SD Card Slot |
| 8. Camera Case | |

Control Panel



Button operation instruction

	Power On/Off, press and hold 3 seconds to off.
	To show or hide the menu/Delete button in the playlist.
	Select a Visualizer input signal.
	Capture a still image.
	Record a video clip, and press it again to stop recording.
	Freeze the image / Press and hold for 3 seconds to split
	Re-display stored images and videos.
	Image rotation of 0°,90°,180°, and 270°.
	Select resolution from 720P, 1080P, and 4K directly.
	Control the arm lamp and bottom lamp.
	Autofocus.
	Move the cursor Left/Focus Far.
	Move the cursor Right/Focus Near.
	Move the cursor Up/Increase the brightness.
	Move the cursor Down/Decrease the brightness.
	Confirm key.
	Zoom in.
	Zoom out.

Remote Control

Power	Control the visualizer on/off
Lamp	Control the arm lamp and bottom lamp
Auto	autofocus
Setting	Select the Visualizer input signal
Source	Select the Visualizer input signal
Resolution	Select resolution from 720P, 1080P, and 4K directly
< OK >	Move the cursor Left, Right, Up, Down/Confirm
Menu	Invoke menu

Zoom in/ Zoom out	Increase and decrease magnification
Snap	Capture a still image
Record	Record a video clip
Far/Near	Focus near or far
Freeze	Freeze the image, press again to unfreeze
Playback	Re-display stored imaged and videos
Flip	V-Reverse the image
Rotate	Image rotation of 0°,90°,180°,270°

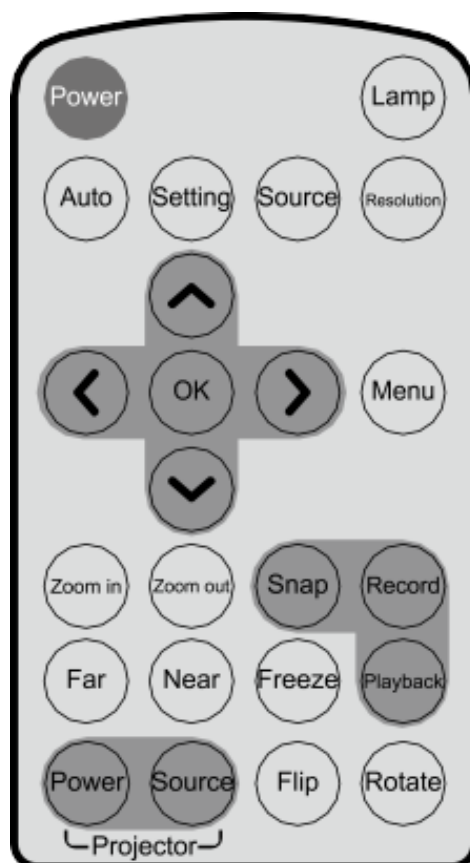

Basic Preparations

1. Place one hand firmly on the base of the visualizer, while carefully lifting the camera stand using the other hand.

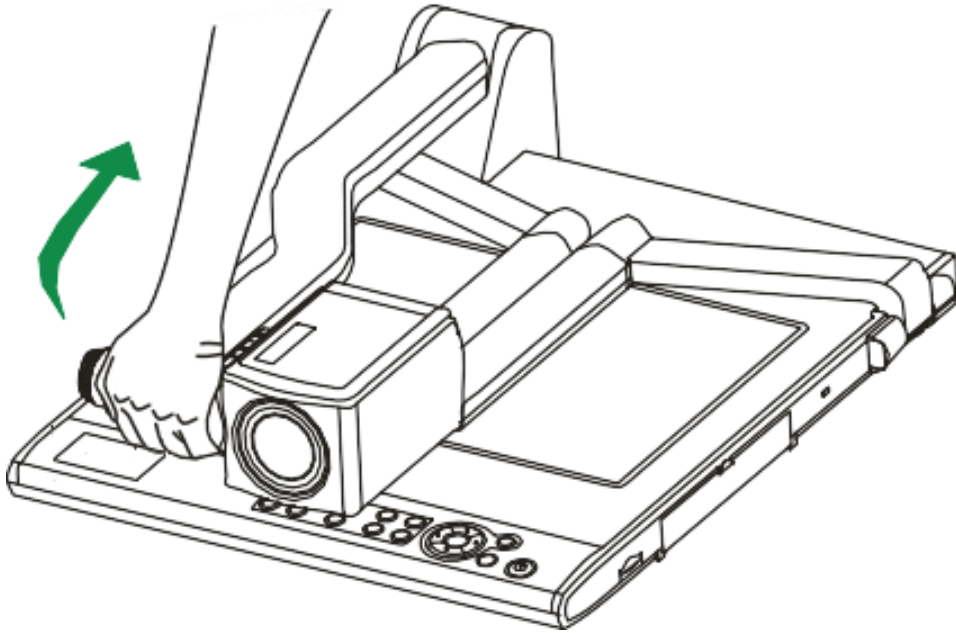

2. Open the arm lights and rotate the camera head until they are properly positioned.

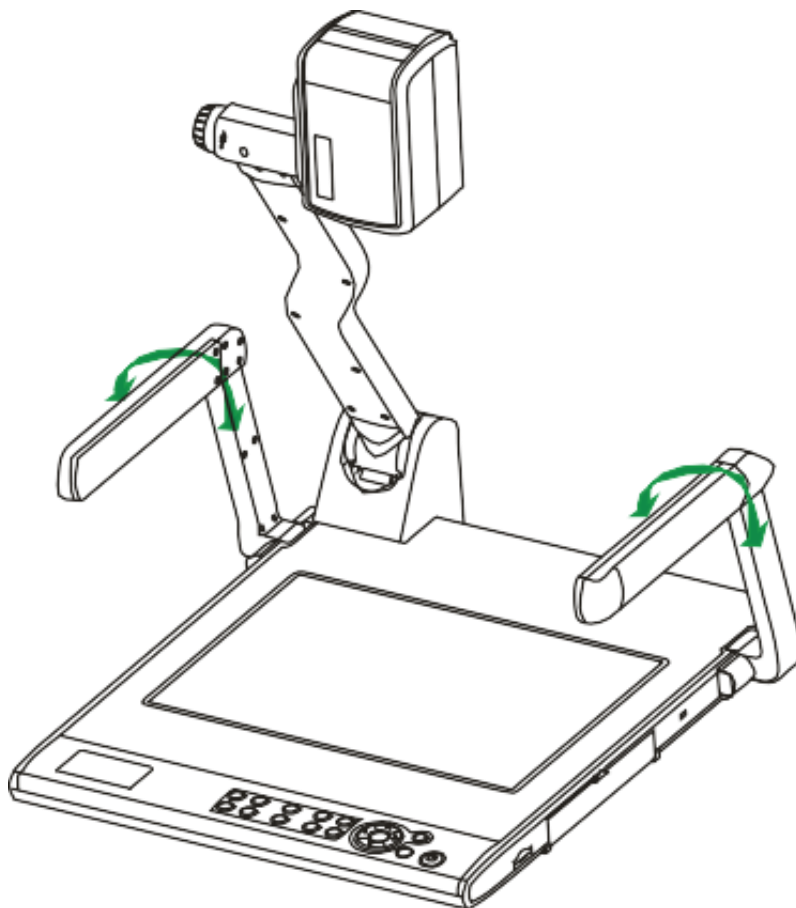

Making Connections

● Connect to the projector or monitor

Use the HDMI cable to connect the HDMI out port to the projector's or monitor's HDMI input port.

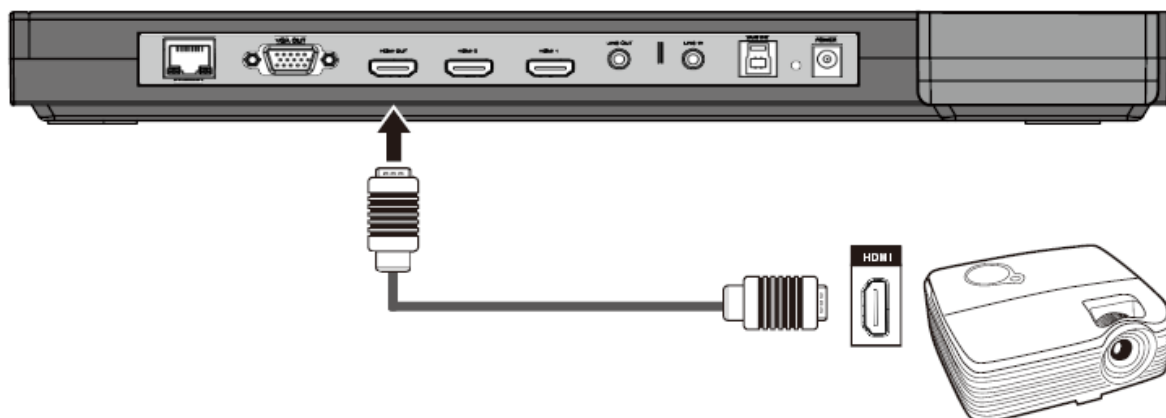

 You can also connect the VGA OUT port to the matching port.

● Connect to a desktop computer

Use the HDMI cable to connect the HDMI out port to the monitor's HDMI input port.

Use the HDMI cable to connect the HDMI in 1 port to the computer's HDMI out port.

Now You can switch sources to display the computer or camera screen.

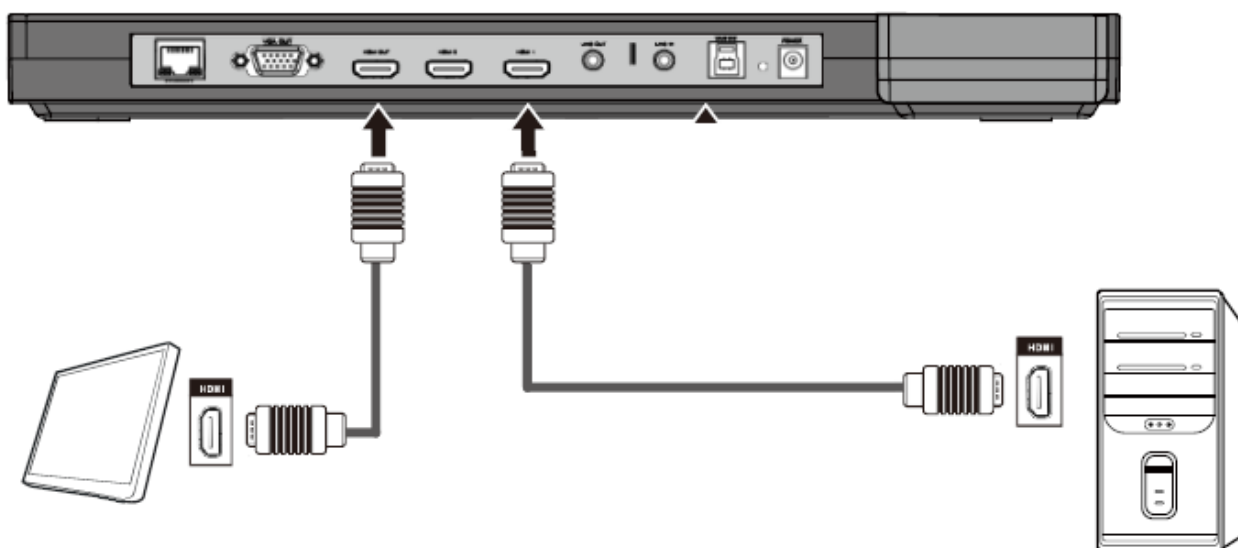

● Connect power source



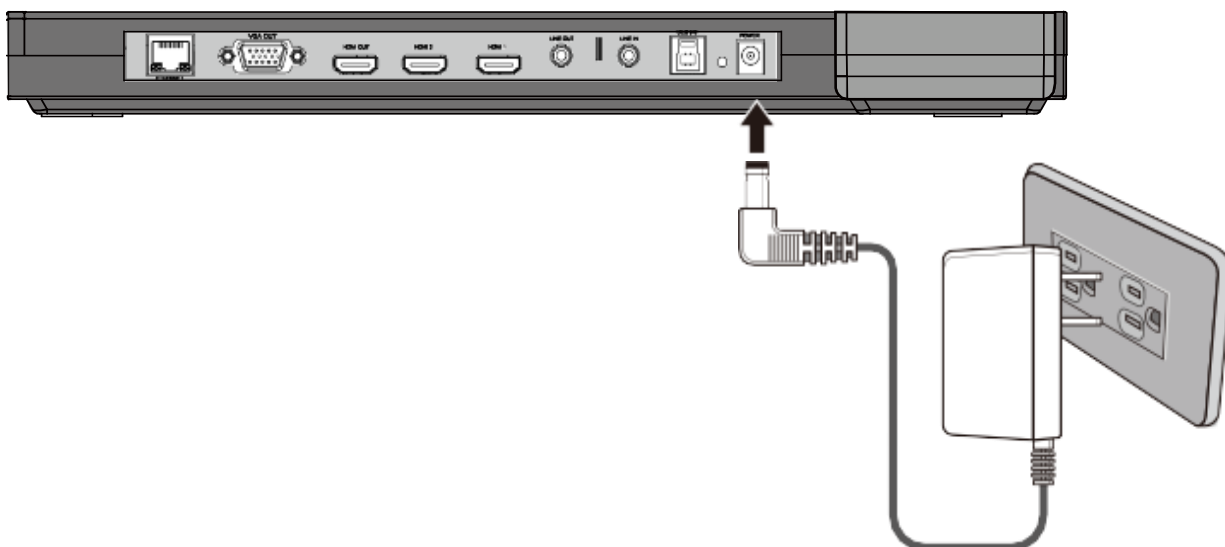







Connect the power cord to the 12V IN connector.









Before making any connections, turn off all the power. Please ensure that the visualizer along with all other equipment to be connected are turned off.

Mouse Operating Instructions

Move the mouse guide to the bottom middle of the screen, and the operation menu will pop up, and the menu functions are as follows:

Name	Icon	Name	Icon	Name	Icon
Annotation		Auto		Zoom in	
Zoom out		Rotate		Mirror	
Freeze		Snap		Record	
Replay		Setting			

Menu Operating Instructions

Name	Icon	Selection	Functions Description
Function		Resolution	720P/1080P/2160P
		Focus Mode	Auto Focus/ Manual Focus
		Mask	Activate the Mask function
		Split	Activate the Split function
Image Setting		Photo Resolution	3840*2160
		Recording Resolution	2160P@30FPS/1080P@30FPS/ 720P@30FPS
System Setting		Language	Support Chinese, English
		System Time	/
		Time Setting	User-defined
		Display Information	Set to display the information on top of the display or not.
		File Manager	Copy to external storage
			Delete all
			Format external storage
			Connect USB Drive to PC
			Connect SD card to PC
		System Reset	Ensure/ Ignore
		System Upgrade	Ensure/ Ignore
Lens FW upgrade	Ensure/ Ignore		
PC Control	USB/DB9/PS2		
User Profile	User 1/User 2/User 3		
Effect Setting		Mask Setting	10%-80%
		Mirror	Normal
			Left-right Mode
			Up-down Mode
		Effect	Normal
			Black-white Mode
			Negative Mode
Flicker	Auto/50HZ/60HZ/Disable		
Brightness, Sharpness, DNR, Contrast, Saturation	 Use (▲/▼) to adjust its setting.		
Time-lapse Photo		ON/OFF	
		Interval	User-defined

Basic Operation

- **Device power on**

After connecting the power source, please wait for the source indicator to turn off, only the red light of the power button is on, and then press the power button.

- **Working on the stage**

Place your material on the platform.
Select the enlargement required using the "zoom in/zoom out" knob.
Adjust the focus of the "AUTO" button.

- **Working outside the stage**

To show a 3-dimensional object using the visualizer, place the object on the working surface and adjust the "zoom in/out" and "AUTO" keys. If the object is too large for the stage or if you would like to show it from one of its sides, or a different angle, just place the object behind or in front of the unit and manually tilt the camera head (remove the close-up lens before titling the camera head).

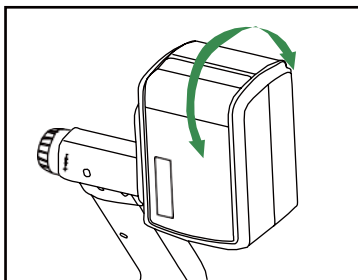

Rotate 330 degrees vertically

- **Light**

The arm lights are powered on when the power is turned on. Each time you press the "LAMP" button, the lighting changes occur as demonstrated.

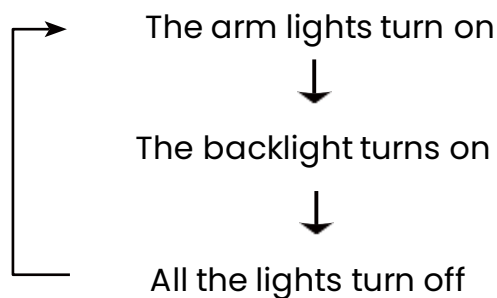

- **Adjusting image size**

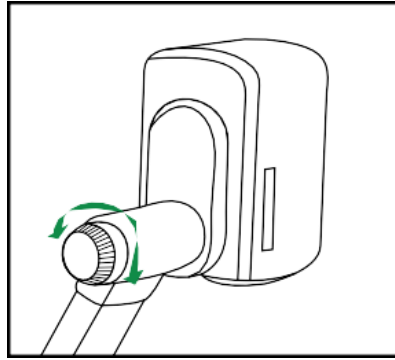

To reduce or enlarge the image size displayed on the screen, rotate the Zoom in or Zoom out knob, or use the buttons on the control panel.

- **Quickly switch resolutions**

The factory default resolution is 1080P, switch the device between 2160p, 1080P, and 720P by clicking the “Resolution” button on the control panel.



When using HDMI OUT to output video signal, when setting 2160p resolution, please make sure your monitor supports the display 4K screen. Otherwise, there will be no screen display, please press the "Resolution" button to switch to other resolutions.

- **Working with negatives**

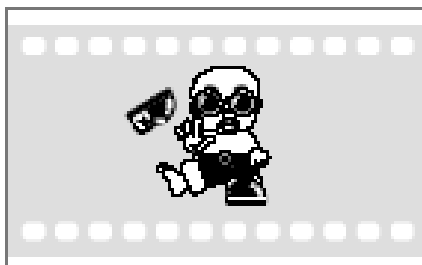

Positive

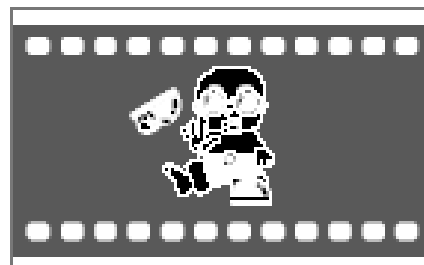

Negative

The visualizer is automatically set to display normal materials on the screen when the power is on. To display negatives, turn on the backlight by pressing the “LAMP” button, and then select (Effect Setting) in the menu-(Effect)-select “Negative” to display the film negatives. In the (Effect) list select “Normal” to display normal materials in the color mode.

- **Focusing**

When the visualizer is turned on the focus automatically adjusts to the stage, press the "AUTO" button to autofocus. You can also manually adjust the focus with the near focus button or the far focus button.

- **Freezing image**

To show a still image on the screen, press the "Freeze" button. The frozen image cannot be adjusted (Zoom in/out, color adjustment, etc.).

- **Recording videos and Play**

Press the "Record" button to Record a video clip, and press it again to stop recording.

Press the "Playback" button, The latest video will be displayed, Use the "up/down/Left/Right" buttons to select the file to be displayed, then press the "OK" button to play the video.



Recorded videos are automatically saved every 20 minutes.

- **Camera / HDMI / VGA inputs**

Press the "Source" button to switch between VGA, HDMI, and Camera signals. Each time the "Source" button is pressed, it provides seamless transitions among different sources such as VGA, HDMI IN 1, HDMI IN 2, and Camera.



HDMI IN signals can only output from HDMI OUT.
VGA IN signals can only output from VGA OUT.

- **Image rotation**

To rotate the image, press the "Rotate" button once, and the displayed image will be rotated 90,180,270 degrees clockwise. Continue to press the "Rotate" button to restore the image to its initial position.

● Infrared remote control

The visualizer's remote control can control the camera from different angles. On the left side of the visualizer stage, there is a built-in remote control storage compartment where you can store the remote control when it is not in use.

Please note that an infrared remote control can only be used up to a certain distance from the unit. Objects situated between the visualizer and the infrared remote control and a weak battery may interfere with the reception.

● Installing visualizer software QCamera

The visualizer is a standard UVC camera - you can use it with a variety of software that supports a UVC camera connection. The visualizer is compatible with the third-party video conferencing software Zoom, Microsoft Teams, or Google Meet. However, to better experience the 4K UHD visualizer UVC function, we'd recommend using it with the QCamera and you can download this free from the QOMO website at the link below.

<https://www.qomo.com/qcamera>



When the UVC function is in use, only Zoom in/out, Near, Far, lamp, brightness, Flip, and Autofocus functions are available on the panel and remote control.



To get the visualizer out of UVC mode, please manually disconnect the Camera from the software or exit the software, do not unplug the USB cable directly.

● Controlling visualizer by computer

You can connect the DB9 (RS232) interface/PS2 interface/USB-type B interface on the visualizer to a computer to control the visualizer.

For example, control via the DB9 interface:

- A. Connect the computer and the visualizer using the RS232 cable.
- B. select (System Setting) in the menu-(PC Control)-select "DB9" to control the visualizer.
- C. Use any serial port debugging software to control.

RS232 code list

Baud rate: 9600bps Stop bit: 1-bit Data bits: 8-bit	
Odd-even check: none Communication encoding: Hex code	
Function	Required Commands (Hex)
Power ON	48 02 28 01 54
Power OFF	48 02 18 02 54
Up	48 02 28 1e 54
Down	48 02 28 1f 54
Left	48 02 28 20 54
Right	48 02 28 21 54
OK	48 02 28 22 54
Menu	48 02 28 14 54
Bottom menu	48 02 28 1d 54
Focus Far	48 04 17 08 00 02 54
Focus Near	48 04 17 08 00 03 54
Autofocus	48 02 18 03 54
Zoom in	48 04 17 07 00 04 54
Zoom out	48 04 17 07 00 05 54
Arm lamp	48 04 16 09 00 01 54
Bottom lamp	48 04 16 09 00 02 54
All lamp Off	48 04 16 09 00 00 54
Brightness Inc	48 04 17 14 00 02 54
Brightness Dec	48 04 17 14 00 03 54
Capture	48 02 28 04 54
Replay	48 02 28 07 54
Record	48 02 28 05 54
720P	48 04 16 12 00 ac 54
1080P	48 04 16 12 00 10 54
2160P	48 04 16 12 00 11 54
B & W	48 04 16 10 00 01 54
Color	48 04 16 10 00 00 54
Rotate	48 04 17 0a 00 01 54
Mirror	48 04 16 0b 00 01 54
Freeze	48 04 16 0c 00 01 54
Switch the source to VGA	48 04 16 13 00 01 54
Switch the source to HDMI2	48 04 16 13 00 02 54
Switch the source to HDMI1	48 04 16 13 00 03 54
Switch the source to Camera	48 04 16 13 00 00 54

Folding The Unit

- Fold the right arm light down first onto the base, then the left arm down. Rotate the camera head clockwise until the camera head is parallel to the camera stand.

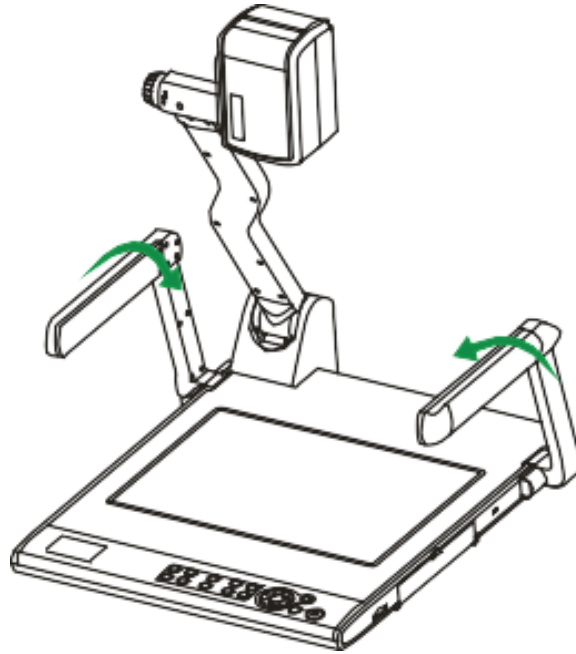

- Carefully fold the camera stand down to the front panel.

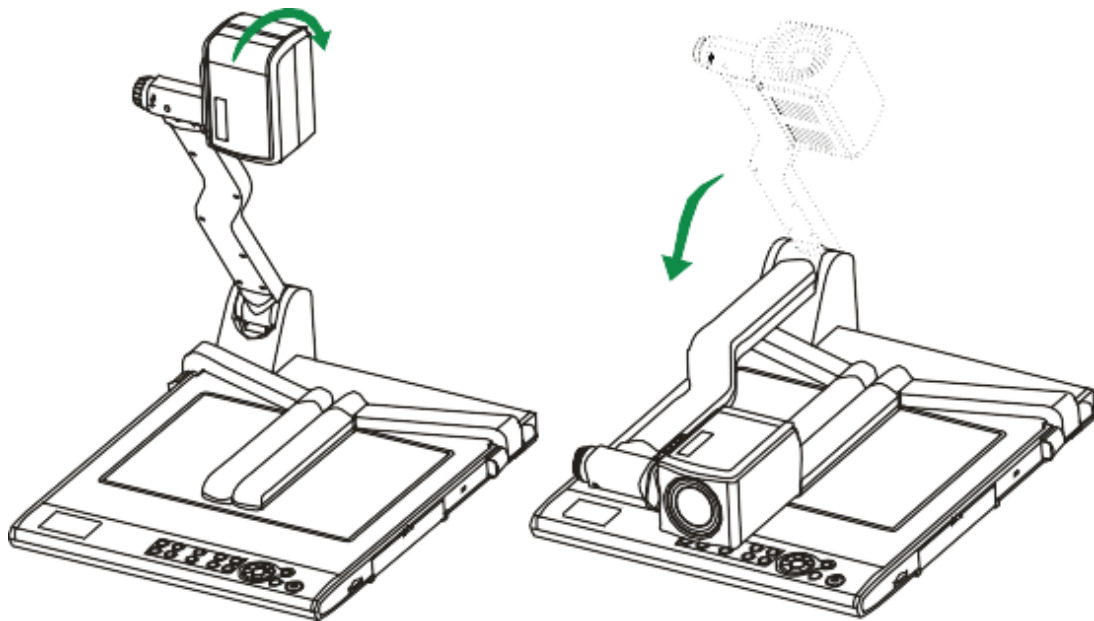

- a. Do not lay the unit down flat.
- b. Do not try to stand it on its rear or sides.
- c. Do not try to pick up this unit by pulling the camera

Problems And Solutions

Problem	Possible causes	Solutions
The device does not turn on in the normal condition.	The power adapter is not connected correctly to the device or the power socket.	Make sure the power adapter is connected correctly to the device and power socket.
After the device is connected, there is no image output.	The device is not connected to the external equipment correctly.	Re-connect the device with the external equipment.
	The external equipment is not selected correctly.	Select the correct external equipment.
	The resolution of the external equipment is set incorrectly.	Reset the resolution of the external equipment.
	The device is not switched to the correct source of signals.	Switch to the correct source of signals.
	The computer transfer key (VGA) is activated.	Press the source of the signal (CAM).
	HDMI is activated.	Press the source of the signal (CAM).
The image can not be moved around.	The image can not be moved around because the Freeze function of the device is activated.	Press again the Freeze function key on the control panel or the remote control to deactivate the function.
The remote control does not respond.	The battery runs out.	Please replace the battery.
	Objects are located between the remote control and the device and block the communication signals.	Please remove the objects that block the communication signals.
	The distance between the remote control and the device is too far.	Please shorten the distance between the remote control and the device.

Specifications

Lens	10X Optical Zoom 10X Digital Zoom
Shooting Area	A4
Video Resolution	720P: 1280 x 720 1080P: 1920 x 1080 2160P: 3840 x 2160
Image sensor Resolution	8.3 Mega UHD
Frame Rate	4K@30fps max
Camera Rotation	Vertically 330°
Image Rotation	0°/90°/180°/270°
Input Connector	HDMI 1.4b x 2 USB2.0 TYPE A x 1 RS232 DB9 x 1 RS232 PS2 x 1 VGA x 1 VGA AUDIO x 1 Line in x 1 RJ45 x 1
Output Connector	Line out x 1 USB3.0 Type B x 1(UVC) HDMI 1.4b x 1(4K@30fps) VGA x 1(1080P@60ps)
Microphone	Built-in
USB (UVC)	Yes
Video Output	Yes
On board Memory	Yes
Memory card	SD
LCD Preview	Yes
Focus	Auto/Manual selectable
White balance/exposure	Auto
Image split	Yes
Negative/positive conversion	Yes
Black/white and color selection	Yes
Image Freeze	Yes
Mirror	Yes
Remote Controller	Yes
Annotation	Yes
Mouse control	Yes
Ethernet	Yes
Lights	Arm Lamp: 1.5W LED lamps x 2 Bottom Lamp: 2.5W LED lamps
SD Card Slot	Yes (64GB max)
USB Memory Slot	Yes

Power Requirements	12V 2A external AC adapter
Dimension (W x D x H)	Folded: 510 x 410 x 120mm
	Setup: 510 x 530 x 570mm
	Packing: 600 x 200 x 480mm

Note: Specifications are subject to change without notice



Qomo.com 1-866-990-7666 support@qomo.com