

QD3900H2

User Manual



Model: QD3900H2
V1.0.38

Contents

Parts Identification.....	2
Control Panel.....	3
Remote Control.....	4
Making Connections.....	6
Menu Operating Instructions.....	9
Basic Operation.....	11
USB Port.....	15
Folding The Unit.....	20
Problems And Solutions.....	21
Specifications.....	22

Precautions

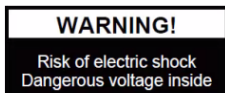

● Please follow these precautions:

- To prevent fire or shock hazard, do not expose the unit to rain or moisture.
- To prevent electrical shock, do not open the cabinet. Refer to qualified personnel for service only.
- Do not use the unit continuously for more than 24 hours with camera auto focus on. It may cause damage to the camera lens.
- Be careful not to spill water or other liquids onto the unit, or allow combustible or metallic objects to get inside the cabinet.
- Unplug the visualizer from the wall outlet when it is not in use for an extended period of time.
- Clean cabinet with a soft cloth lightly moistened with a mild detergent. Clean lens carefully with an air spray or soft dry cloth to avoid scratching. When lamps flash or become dark, they should be replaced with new ones. Avoid interchanging arm lamps and bottom lamp frequently.

Parts Identification

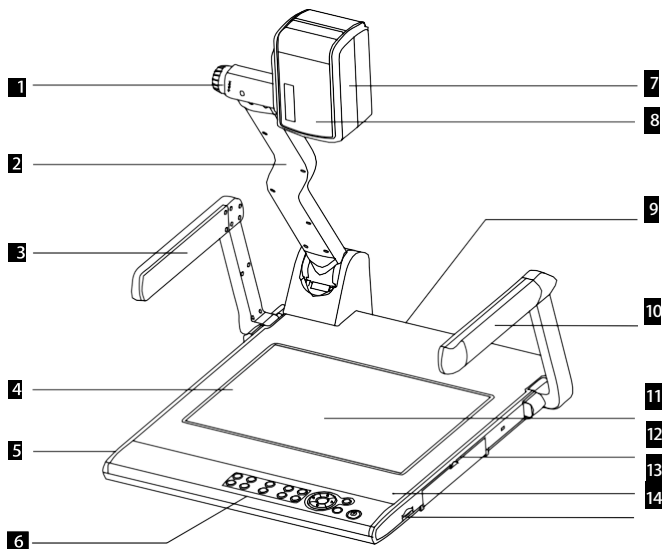

1 Zoom in/Zoom out Knob

2 Camera Stand

3 Left Arm Lamp

4 Bottom Lamp

5 Remote Control Slot

6 Control Panel

7 Camera Case

8 Infrared Receive Area

9 Rear Connector

10 Right Arm Lamp

11 Work Stage

12 Side Connector

13 Built-in Microphone

14 SD Card Slot

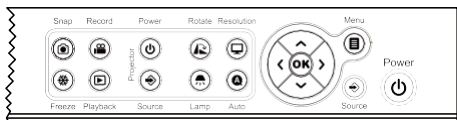

Control Panel

● Button operation instruction



Button	Function
	Power On/Off, press and hold 3 seconds to off
	To show or hide OSD menu/Delete button in playlist
	Select Visualizer input signal
	Capture a still image, It's better to insert external storage .
	Record a video clip, press it again to stop recording.After inserting external storage
	Freeze the image, press again to unfreeze. Hold Freeze button for 3s enter/exit split
	Re-display stored imaged and videos
	Image rotation of 90° , 180° , 270°
	Select resolution from XGA, SXGA, WXGA, 720P, 1080P,800P and 1200p directly
	Control the arm lamp and bottom lamp
	Automatic white balance, auto focus and auto adjust brightness
	Move the cursor Left/zoom out
	Move the cursor Right/zoom in
	Move the cursor Up/Increase the brightness
	Move the cursor Down/Decrease the brightness
OK	Confirm key
	Projector On/Off, press and hold 3 seconds to off
	Select Projector input signal

Remote Control

Power	Control the visualizer On/ Off
Lamp	Control the arm lamp and bottom lamp
Auto	Automatic white balance, auto focus and auto adjust brightness
Setting	Invoke setting menu
Source	Select Visualizer input signal
Resolution	Select resolution from XGA, SXGA, WXGA, 720P, 1080P, 800P and 1200P directly
	
	Move the cursor Left, Right, Up, Down/Confirm
Menu	Invoke menu

Zoom in/ Zoom out	Increase and decrease magnification
Snap	Capture a still image
Record	Record a video clip
Far/Near	Focus near or far
Freeze	Freeze the image, press again to unfreeze
Playback	Re-display stored imaged and videos
Projector Power	Control the Projector On/ Off
Projector Source	Select Projector input signal
Flip	V-Reverse the image
Rotate	Image rotation of 90° , 180° , 270°

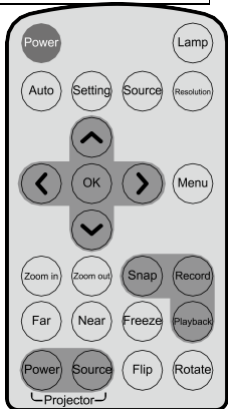

Basic Preparations

1. Place one hand firmly on the base of the visualizer, while carefully lifting up the camera stand using the other hand.

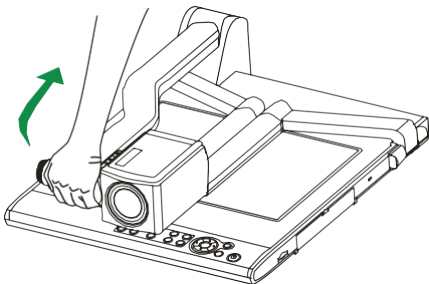

2. Open the arm lights and rotate the camera head until they are properly positioned.

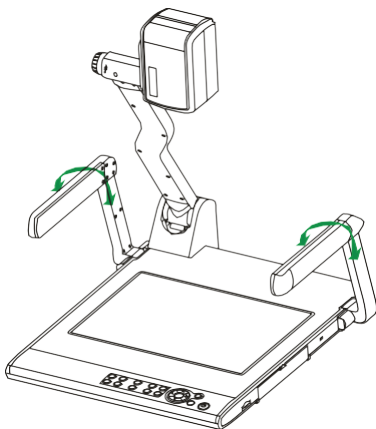

Making Connections

● Connect to the projector

Connect the PROJECTOR port to the projector's RGB IN port using the RGB cable.

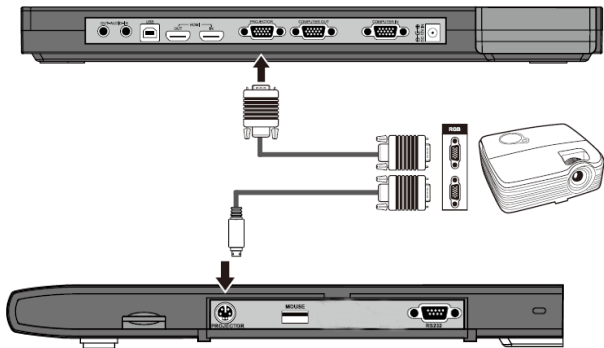

You can also control a projector using the controls on the visualizer by connecting the projector to the visualizer using an RS232 cable. Some projector models may require a converter cable in addition to this standard RS232 cable to connect to the projector control port, for the pin locations and shape of some projectors' control port connector may be different from the connector of a standard RS232 cable. Once the visualizer

is connected to the projector, you can control the projector's power on, standby and input selection by using the visualizer. (Aside from Hitachi projectors, the Code Writing program that comes with the visualizer is required to access this function.)



You can also connect the HDMI OUT port to the projector's the matching port.

- **Connect to a desktop computer**

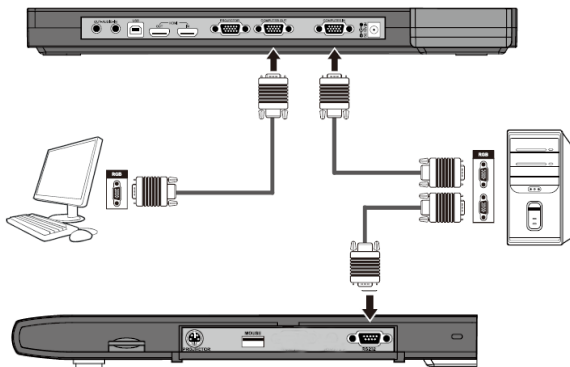

You can connect a laptop computer to the RGB IN port of side panel using a RGB cable or connect a desktop computer to the HDMI IN port of rear panel using a HDMI cable.

- **Connections for external control from the computer**

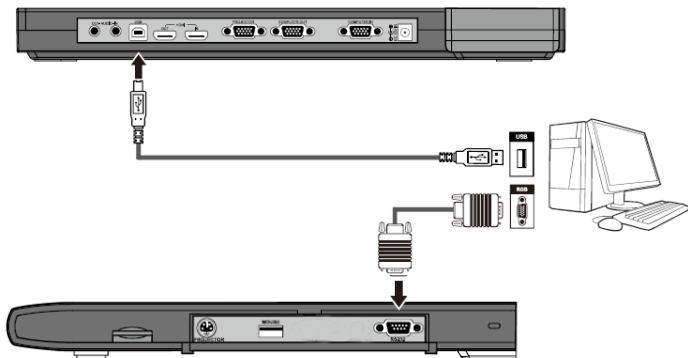

Use the computer RS232 cable to make the connections displayed below to control the visualizer from an external computer.

A USB connection enables the computer to capture still images and/or video streams from the visualizer. Special software is required for this operation.



● **Connect power source**

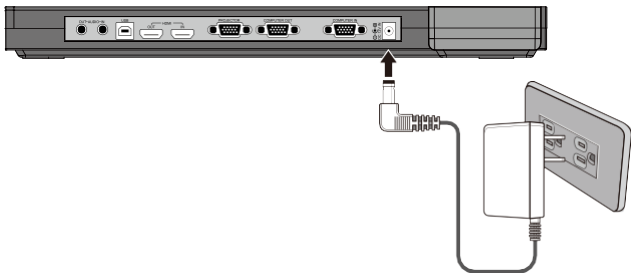



First connect the power cord to the 12V IN connector.



Before making any connections, turn off all the power. Please ensure that the visualizer along with all other equipment to be connected are turned

Menu Operating Instructions

OSD MENU			
Name	Icon	Selection	Functions Description
Function		Resolution	XGA
			SXGA
			WXGA
			720P
			1080P
			1280*800
			1920*1200
		Focus Mode	Auto Focus
			Manual Focus
		Mask	ON
			OFF
		Highlight Line	ON
			OFF
		Sound source	Mic
Audio in			
Audio in	OFF		
	1-5		
Audio out	OFF		
	1-5		
Image Setting		Photo Resolution	1280*720
			1920*1080
			2688*1512
		Recording Resolution	1080P@30FPS
Video format	VGA		
	AVI		
System Setting		Language	Support Chinese, English, Spanish, Russian, French, German and Italian.
		System Time	/
		Time Sett	User defined
		Display Information	Set to display the information on top of the display or not.
		USB to PC	PC Camera
			Mass Storage
		File Manager	Copy to external storage
			Delete all
		System Reset	Format external storage
			Ensure
Upgrade	Ignore		
		Ensure	

			Ignore
		NTSC/PAL	NTSC
			PAL
		User Profile	User 1
			User 2
			User 3
Effect Setting		Mask Setting	10%-80%
		Image Mode	Video
			Text
		Mirror	Normal
			Left-right Mode
			Up-down Mode
		Effect	Normal
Black-white Mode			
Negative Mode			
Frame per second	50HZ/60HZ		
Brightness, Sharpness, DNR, Contrast, Saturation	 Use () to adjust its setting.		
Time-lapse Photo		ON/OFF	ON
			OF
		Interval	User defined
Information		Firmware version: xxx	
		Hardware version: xxx	
		Release Date: xxx	

Basic Operation

● PAL/NTSC video outputs

You can set PAL or NTSC mode in the setting menu.

● Working on the stage

1. Place your material on the platform.
2. Select the enlargement required using the “zoom In/zoom out” knob.
3. Adjust the focusing the “AUTO” button.

● Working outside the stage

To show a 3-dimensional object using the visualizer, place the object on the working surface and adjust the “zoom In/out” and “AUTO” keys. If the object is too large for the stage or if you would like to show it from one of its side, or a different angel, just place the object behind or in front of the unit and manually tilt the camera head (remove the close-up lens prior to titling the camera head).

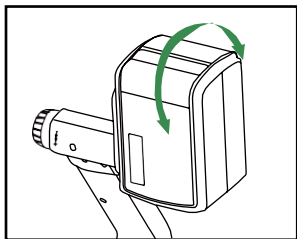

Rotate 330 degrees vertically

● Light

The arm lights are powered on when the power is turned on. Each time you press the "LAMP" button, the lighting changes occur as demonstrated.

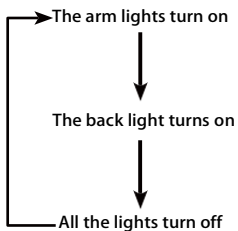

● Adjusting image size

To reduce or enlarge the image size displayed on the screen, rotate the Zoom in or Zoom out knob.

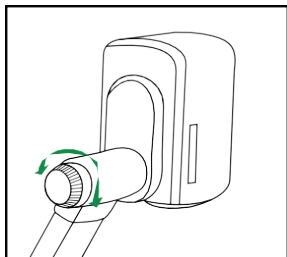

● Working with negatives

The visualizer is automatically set to display normal materials on the screen when the power is on. To display negatives, turn on the back light by pressing the " LAMP " key, and then select (Effect Setting) in menu— (Effect) —select " N e g a t i v e " to display the film negatives. In (Effect) list select " N o r m a l " to display normal materials in the color mode.

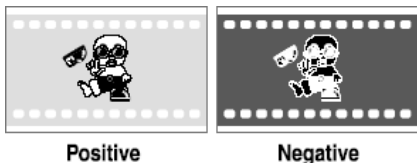

● Focusing

When the visualizer is turned on the focus automatically adjusts to the stage, press the " A U T O " button to autofocus.

● Freezing image

To show a still image on the screen, when the output signal is RGB, press the " Freeze " button. The frozen image cannot be adjusted (Zoom in/out, color adjustment, etc.).

● White balance adjustment

Each time the lighting condition changes, the user should adjust the white balance of the CAM.

Press the " A U T O " button to adjust the white balance automatically.

● Auto adjustment

One of the visualizer's special functions is auto adjustment. Press the " A U T O " button to auto adjust the brightness, the white balance and the focus.

● Text/Video mode

Select " Effect Setting " in menu— " I m a g e M o d e " to switch between Text/Video modes. To display a text file, switch to the text mode to get a clearer text effect.

● Color and B&W mode switch

Select “Effect Setting” in menu— “Effect” —select “Black-White Mode” to enter the Black & White mode; In the list of “Effect” select “Normal” to return to the Color mode.

● Computer / Camera / RGB / HDMI inputs

Press the “Source” button to switch between HDMI, COMPUTER, RGB and Camera signals. Each time the “Source” button is pressed, it provides seamless transitions among different sources such as COMPUTER (IN), RGB (IN), HDMI (IN) and Camera.



COMPUTER OUT always outputs COMPUTER IN signals. HDMI IN signals can only output from HDMI OUT.
RGB IN signals can only output from PROJECTOR.

● Projector on/stand by

Press the “POWER” button to turn on the visualizer’s power and press the “PROJECTOR POWER” button to turn the projector power on. To place the projector on standby after the use, press the “PROJECTOR POWER” button and hold for more than 3 seconds.

● Projector inputs selection

When the projector is connected to several input sources, use the “PROJECTOR SOURCE” button to switch between projector signal inputs.

● Image rotation

In order to rotate the image, press the “Rotate” button once, the displayed image will be rotated 90, 180, 270 degrees clockwise. Continue to press the “Rotate” button to restore the image to its initial position.

● Image reversion

To display a vertically mirrored image, press the “Flip” button. Press the “Flip” button again to exit.

● Infrared remote control

The visualizer’s remote control can control the camera from different angles. On the left side of the visualizer stage, there is a built-in remote control storage compartment where you can store the remote control when it is not in use.

Please note that an infrared remote control can only be used up to a certain distance to the unit.

Objects situated between the visualizer and the infrared remote control and a weak battery may interfere with the reception.

● Installing visualizer software

This function is to snap and display images with the USB interface, which includes displaying static and dynamic pictures, snapping dynamic images and playback the dynamic images with the Windows Media Player or its own player.

A. Insert the CD-ROM that comes with the visualizer into the CD-ROM drive. If Auto run is enabled on your system, then the Software Setup window will be displayed automatically as below.

If it does not start automatically, after inserting the CD-ROM, Click [Start]→ [My Computer], and doubleclick  (the CD-ROM drive letter might be different in different computer systems), and then the above screen will appear immediately.

B. Click the Capture Program file to install the program that captures images in the AVI or JPG format.

C. Click the Code-Writing Program file to install Code-Writing Program.

D. Shut down your computer when prompted in order for the changes to take effect.

E. Use the USB2.0 cable provided to connect your computer to the visualizer before your computer is restarted.

USB Port

The USB port can be used to store still images from the visualizer in a computer. Connect the visualizer to your computer with the supplied USB cable. The visualizer software is available on the supplied CD-ROM.

* Please pay attention to the following:

1. Computer hardware requirement: CPU: 2.4GHz, RAM: 256M or above, Graphic card 64M, USB 2.0 port, Hard disk 40G or more, Monitor display resolution higher than XGA (1024x768).
2. Operating system: Windows XP SP2, Win7.
3. Must use a high-speed USB 2.0 cable provided.
4. When connecting the visualizer to a desktop computer with the high-speed USB 2.0 cable provided, we recommend using the USB port located on the rear of the mainframe. The USB port on the front of the computer might have interference.

● Controlling visualizer by computer

You can control the visualizer from a computer connected with a RS232 connector.

- A. Connect the computer and the visualizer using the RS232 cable.
- B. Doubleclick X:\232 Control\ControlPanel(you can open this file from the CD and doubleclick it, or copy this file to any directory on your computer's hard drive and doubleclick to launch it).

● Controlling projector by visualizer

The code writing software is used to inputting projector's control code, then can control various projector with the visualizer.

1. Click the Code-Writing file to install Code-Writing Program.
2. Connect the visualizer to the projector with the RGB cables.
3. Connect the RS232 cable to the computer's connector. The visualizer's RS232 port is located on its right side.
4. After completion of the connection, turn on the visualizer, click [start]->[All Programs]-> Visualizer->  Visualiser Code-Writing and the following dialog box appears as below:

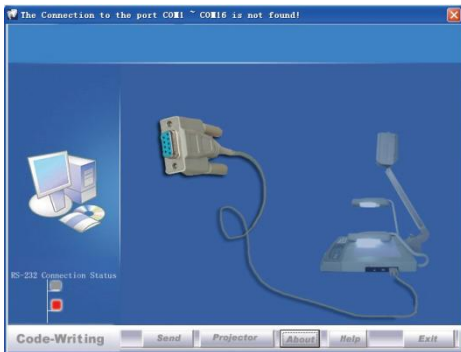

When the indicator of " Current RS-232 Connection Status " is green, that means the connection between the visualizer and the computer's RS232 connector is good. If the indicator is red, please check if the RS232 cable is connected correctly. When all the cables are connected correctly, please click

" P r o j e c t o r " to select your projector model under the drop-down list, then click " S e n d " . If you can not find your particular projector model in the " P r o j e c t o r " , please do the following:

1. Select “ Baud rate ” and “ parity ” and input the projector control code. (The baud rate, parity and control code is supplied by projector’s manufacturer, please refer to the projector’ manual)

2. The input format of projector’s control code is as follows:

a. If the data is in the numerical value format, please input data directly, block them off with comma, do not distinguish lowercase and uppercase.

For example: the “ POWER ON ” code in Hitachi projector manual is :

BE · EF · 03 · 0	BA · 0	01 · 0	00 · 6	01 · 0
6 · 00	2	0	0	0

In the POWRE ON box, Input : be, ef, 03, 06, 00, ba, d2, 01, 00, 00, 60, 01, 00. Then use the same input rule to input other code.

b. If the data is in the character string format, input ‘ character string’ .

Forexample: the “ POWERON ” code in the SHARPC40/50 projector manual is:

P	O	W	E	-	-	-	1	↩
---	---	---	---	---	---	---	---	---

(“ - ” isspace, ↩ is enter.)

In the POWER ON box, input ‘ POWER 1 ’ , 0d, 0a

Remarks: There are 3 spaces after POWER, 0d, 0a is enter.

Input other codes in the same way.

c. If the data is in the numerical value and character format, then synthesize the above-mentioned formats.

3. Once done, click “ Add ” to add your projector model, then Click “ Send ” . Afterward, click “ Ok ” . Now, you can use the visualizer to control your projector.

4. Connect the visualizer's projector control port to the RS232 port with a RS232 cable (Please disconnect the computer from the RS232 port first) . Then use buttons on the operation panel to control the projector.

The visualizer provides a 6-pin to 9-pin RS232 cable. If this cable does not match to your projector's RS232 port, an additional RS232 cable is needed. This additional RS232 cable can be made based on the pin location of the projector's RS232 control port. The pin locations of the visualizer are: the pin 1 is RXD (Received Data); the pin 5 is TXD (Transmitted Data); the pin 4 is GND (Ground). Other pins are not defined. The pin location information of the projector is provided by the projector's manufacturer. The projector's RS232 control port normally has RXD pin, TXD pin and GND pin, the name may be different. The parallelism of each data pin is shown as follows:

Visualizer's RXD pin ----- Projector's TXD pin

Visualizer's TXD pin ----- Projector's RXD pin

Visualizer's GND pin ----- Projector's GND pin



5. If you can not use buttons on the operation panel to control the projector, please use Code- Writing software's projector control code testing function to check if the control code is correct.

Click “ Projector ” button, the following dialog box appears as below:



Connect the visualizer to a computer with a RS232 cable (Please disconnect the projector from the RS232 port first) and select the Baud Rate and Parity based on the projector's Baud Rate, then click the “ TEST ” button to pop up the Projector Code Test dialog box, input the Baud Rate and Parity based on the projector's Baud rate, then click “ Open ” .

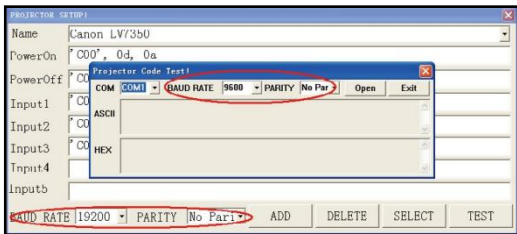

Click the projector control buttons on the visualizer's operating panel to check if the control code that the program received is the same as the sending code. If the receiving code is same to the sending code, the input codes are correct. If the visualizer can not control the projector, please do the following.

1. Check to see if the source control codes of projector are correct.
2. Check to make sure the connection between the visualizer and the projector is correct.

Folding The Unit

Fold the right arm light down first onto the base, then the left arm down. Rotate the camera head clockwise until the camera head is parallel to the camera stand

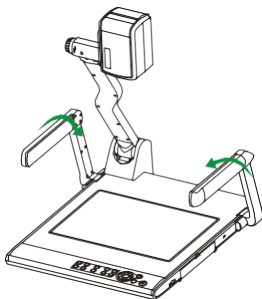

Carefully fold the camera stand down to the front panel

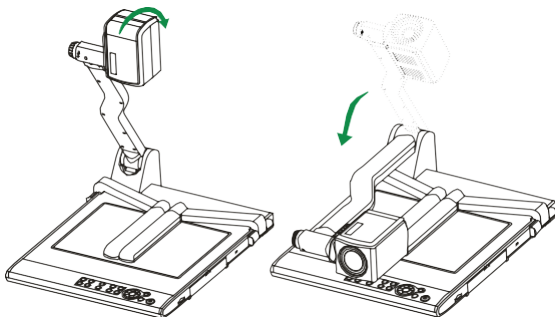

- Do not lay the unit down flat.
- Do not try to stand it on its rear or sides.
- Do not try to pick up this unit by pulling the camera stand

Problems And Solutions



Check the solutions below if you are having trouble using the Portable

Visualiser:

Problem	Possible causes	Solutions
The device does not turn on in normal condition.	The power adapter is not connected correctly to the device or the power socket.	Make sure the power adapter is connected correctly to the device and power socket.
The device is unable to capture images or record videos.	The SD card is protected.	Reset the SD card to be writable.
After the device is connected, there is no image output.	The device is not connected to the external equipment correctly.	Re-connect the device with the external equipment.
	The external equipment is not selected correctly.	Select the correct external equipment.
	The resolution of the external equipment is set incorrectly.	Reset the resolution of the external equipment.
	The device is not switched to the correct source of signals.	Switch to the correct source of signals.
	The computer transfer key (VGA) is activated.	Press the source of signal (CAM).
	HDMI is activated.	Press the source of signal (CAM).
The image can not be moved around.	The image can not be moved around because the Freeze function of the device is activated.	Press again the Freeze function key on the control panel or the remote control to de-activate the function.
The remote control does not respond.	The battery runs out.	Please replace with 2 new AAA batteries.
	Objects are located between the remote control and the device and block the communication signals.	Please remove the objects that block the communication signals.
	The distance between the remote control and the device is too far.	Please shorten the distance between the remote control and the device.

Specifications

Resolution	XGA:1024*768; SXGA:1280*1024; WXGA:1280*768; 720P:1280*720;1080P:1920*1080;800P:1280*800;1200P:1920*1200
Total Pixels	5.0Mega
Lens	10 x optical zoom 10 x digital zoom
Camera Rotation	Vertically 330°
Focus	Auto/Manual selectable
White balance	Auto
Negative/Positive conversion	Yes
Black/White and color selection	Yes
Image/Text mode conversion	Yes
Image Title	Yes
Image Freeze	Yes
Image split	Yes
Image Mirror	Yes
Image Rotate	0° ,90° ,180° ,270°
Lights	Arm Lamp: 1.5W LED lamps x 2
	Bottom Lamp: 2.5W LED lamps
Input connectors	HDMI*1; USB TYPE A*1; USB TYPE B*1;MIC (built in)*1;RS232 DB9*1; VGA*1; Audio IN (Mini Jack)*1
Output connectors	HDMI*1; Audio OUT (Mini Jack)*1 ; VGA*2; RS232 PS2*1;
Operating system	Win7/Win8/win10/win11

Power requirements	12V 2A external AC adapter
Dimension (W x D x H)	Folded: 510 x 410 x 120mm
	Setup: 510 x 530 x 570mm
	Packing: 600 x 200 x 480mm
Weight	N.W: 5.0Kg G.W: 7.0Kg