

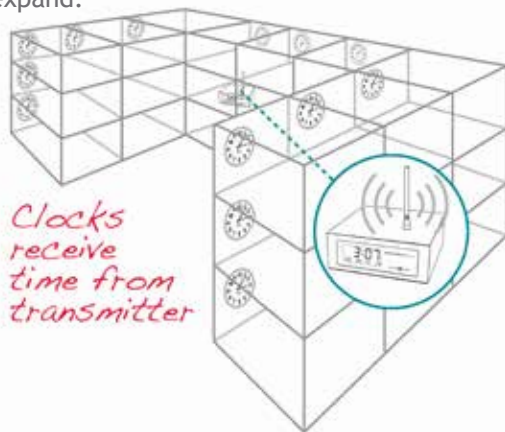

## RF Wireless Analog Clock Series

Improve efficiency and productivity with synchronized time throughout an entire facility.

TimeTrax Sync™ RF Wireless Synchronized Analog Clocks receive a dependable time signal from RF Wireless Transmitter (sold separately). The compact transmitter broadcasts time signal over 128 signaling channels (902-928MHz) to ensure time transmission with no interference. Transmitter requires no FCC license for operation and includes TimeTrax Sync™ software interface for NTP server selection. Clocks are available in a variety of bezel colors, sizes and face styles to complement any environment. Choose from battery operated or 105-120V AC power formats. Custom clock faces also available to display your organization logo. The TimeTrax Sync™ RF Wireless Analog Clock System is simple to install and easy to expand.



- Receives official, accurate time signal from RF Wireless Transmitter
- Transmitter broadcasts time signal using frequency-hopping 902-928 MHz (128 signaling channels) to ensure no interference
- No FCC license required for operation
- Variety of bezel colors, sizes and face formats
- Choose from battery or 105-120V AC models
- Automatic Daylight Saving Time adjustment
- Includes anti-theft wall bracket for safe and secure wall mounting
- Three-year manufacturer's limited warranty

### RF Wireless Analog Clock Series Ordering Information

#### TIMETRAX SYNC™ BATTERY OPERATED BLACK BEZEL SERIES

Part No.	Description
S9A3AAGBXB	13" Black Bezel, 12 Hour
S9A3ACGBXB	13" Black Bezel, 12/24 Hour
S9A7AAGBXB	17" Black Bezel, 12 Hour
S9A7ABGBXB	17" Black Bezel, 12 Hour w/seconds
S9A7ACGBXB	17" Black Bezel, 12/24 Hour

#### TIMETRAX SYNC™ 105-120V AC BLACK BEZEL SERIES

Part No.	Description
9A13AE	13" Black Bezel, 12 Hour
S9A3ACGALB	13" Black Bezel, 12/24 Hour
S9A7AAGALB	17" Black Bezel, 12 Hour
S9A7ABGALB	17" Black Bezel, 12 Hour w/seconds
S9A7ACGALB	17" Black Bezel, 12/24 Hour

#### TIMETRAX SYNC™ BATTERY OPERATED SILVER BEZEL SERIES

Part No.	Description
S9A3ADGBXS	13" Silver Bezel, 12 Hour
S9A3AEGBXS	13" Silver Bezel, 12 Hour w/seconds
S9A3AFGBXS	13" Silver Bezel, 12/24 Hour
S9A3AGGBXS	13" Silver Bezel, 12 Hour Abstract
S9A3AHGBXS	13" Silver Bezel, 12 Hour Black
S9A3AIGBXS	13" Silver Bezel, 12/24 Hour Black
S9A3AJGBXS	13" Silver Bezel, Black/Grey 12 Hour
S9A7ADGBXS	17" Silver Bezel, 12 Hour
S9A7AEGBXS	17" Silver Bezel, 12 Hour w/seconds
S9A7AFGBXS	17" Silver Bezel, 12/24 Hour

#### TIMETRAX SYNC™ 105-120V AC SILVER BEZEL SERIES

Part No.	Description
S9A3ADGALS	13" Silver Bezel, 12 Hour
S9A3AEGALS	13" Silver Bezel, 12 Hour w/seconds
S9A3AFGALS	13" Silver Bezel, 12/24 Hour
S9A3AGGALS	13" Silver Bezel, Abstract 12 Hour
S9A3AHGALS	13" Silver Bezel, Black 12 Hour
S9A3AIGALS	13" Silver Bezel, Black 12/24 Hour
S9A3AJGALS	13" Silver Bezel Black/Grey 12 Hour
S9A7ADGALS	17" Silver Bezel, 12 Hour
S9A7AEGALS	17" Silver Bezel, 12 Hour w/seconds
S9A7AFGALS	17" Silver Bezel, 12/24 Hour

#### TIMETRAX SYNC™ BATTERY OPERATED WOOD BEZEL SERIES

Part No.	Description
S9A6AKGBXC	16" Cherry Bezel, Roman 12 Hour
S9A6ALGBXC	16" Cherry Bezel, Arabic 12 Hour
S9A6AFGBXC	16" Cherry Bezel, Arabic 12/24 Hour
S9A6AKGBXO	16" Oak Bezel, Roman 12 Hour
S9A6ALGBXO	16" Oak Bezel, Arabic 12 Hour
S9A6AFGBXO	16" Oak Bezel, Arabic 12/24 Hour
S9A6AKGBXW	16" Walnut Bezel, Roman 12 Hour
S9A6ALGBXW	16" Walnut Bezel, Arabic 12 Hour

\*TimeTrax Sync™ RF Wireless Transmitter required (part #9T1WI or part #S9DWXSLAUB) for clock operation.



ceiling bracket



wall bracket

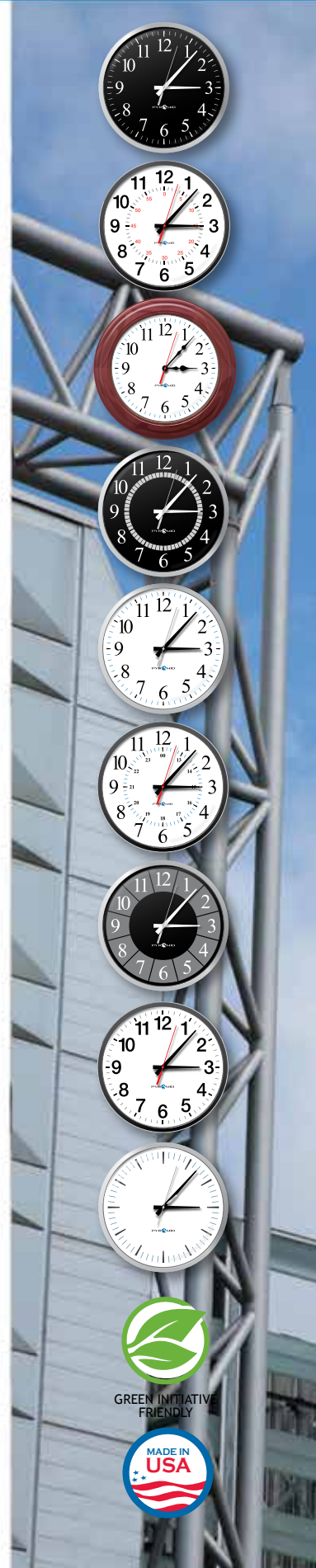

GREEN INITIATIVE FRIENDLY



MADE IN USA



## RF Wireless Analog Clock Series

### SPECIFICATIONS

Time Base	Microprocessor							
Time Update Method	902-928 MHz RF Wireless Frequency Hopping							
Power	3.6V Lithium Battery	105-120V AC 60Hz 12" leads						
Average Current Consumption	5 years (typical)	<1w						
Time Update Frequency	Every 24 hours (2am)	Every 20 seconds						
Operating Temperature	-30° F (-33.44° C) to 130° F (54.44° C)							
Mounting	Double Face, Wall or Ceiling (ABS 13" Bezel)							
Dial Material	Polystyrene							
Lens Material	Non glare, shatterproof transparent polycarbonate							
Bezel Material	Reinforced Acrylonitrile Butadiene Styrene (ABS)	Hardwood						
Bezel Color/Finish	Black or Silver	Cherry, Oak or Walnut						
Dial Format	12 Hour, 12 Hour with seconds, 12/24 Hour or Custom	12 Hour or Roman Numeral						
Dimensions (Dia x D)	13.25" x 2.5" (13") (33.6cm x 6.35cm) 17" x 2" (17") (43.1cm x 5.08cm)	16.5" x 2.25" (41.9cm x 5.7cm)						
Weight	<table border="1"> <tr> <th>Battery Operated</th> <th>105-120V AC</th> </tr> <tr> <td>3.05lbs (1.38kg) (13")</td> <td>3.15lbs (1.42kg) (13")</td> </tr> <tr> <td>4.6lbs (2.08kg) (17")</td> <td>4.7lbs (2.13kg) (17")</td> </tr> </table>	Battery Operated	105-120V AC	3.05lbs (1.38kg) (13")	3.15lbs (1.42kg) (13")	4.6lbs (2.08kg) (17")	4.7lbs (2.13kg) (17")	5.7lbs (2.58kg)
Battery Operated	105-120V AC							
3.05lbs (1.38kg) (13")	3.15lbs (1.42kg) (13")							
4.6lbs (2.08kg) (17")	4.7lbs (2.13kg) (17")							
Shipping Weight	<table border="1"> <tr> <th>Battery Operated</th> <th>105-120V AC</th> </tr> <tr> <td>3.76lbs (1.70kg) (13")</td> <td>3.9lbs (1.76kg) (13")</td> </tr> <tr> <td>5.85lbs (2.65kg) (17")</td> <td>5.95lbs (2.69kg) (17")</td> </tr> </table>	Battery Operated	105-120V AC	3.76lbs (1.70kg) (13")	3.9lbs (1.76kg) (13")	5.85lbs (2.65kg) (17")	5.95lbs (2.69kg) (17")	7.5lbs (3.40kg)
Battery Operated	105-120V AC							
3.76lbs (1.70kg) (13")	3.9lbs (1.76kg) (13")							
5.85lbs (2.65kg) (17")	5.95lbs (2.69kg) (17")							
Warranty	3-Year manufacturer's limited warranty							
Guarantee	30-Day money back guarantee							
Compliance	FCC part 15 section 15,247 FCC id# WC7H9ALGI							
Includes	Security wall bracket and key, User Guide							

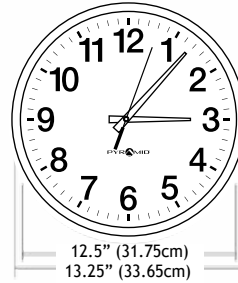

13" Clock Series

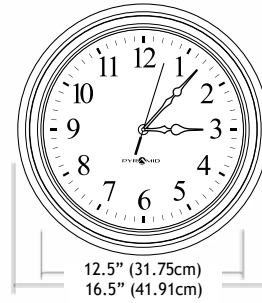
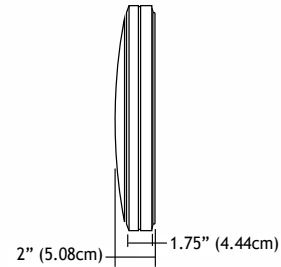

16" Wood Clock Series

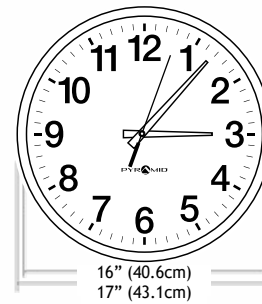
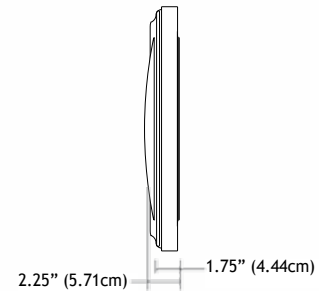

17" Clock Series

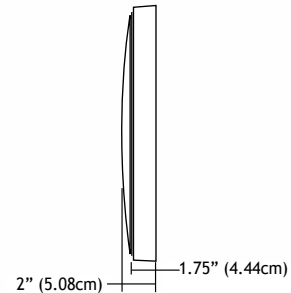

### ACCESSORIES

9T1WI*	Ethernet RF Wireless Transmitter, shelf unit (includes software)
S9DWXSLAUB*	Ethernet RF Wireless Transmitter, wall mount unit (includes software)
S9DSXOLAUB	Ethernet RF Wireless Transmitter, shelf unit (add-on transmitter)
42337	Ethernet RF Wireless Transmitter, wall unit (add-on transmitter)
42224	3.6V Lithium Battery
42328	GPS Signal Receiver
42317	RF Wireless Transmitter Wall Rack
42320	Dual 13" Analog Clock Wall Bracket
42443	Dual Analog & Digital Clock Ceiling Bracket
42314	15" Wire Clock Guard
42315	19" Wire Clock Guard
42690	16.5" Polycarbonate NEMA4 Clock Cover
42606	Analog Security Mount Replacement
42281	Wall Clock Security Mount Replacement Key

\*Either model required for clock operation.

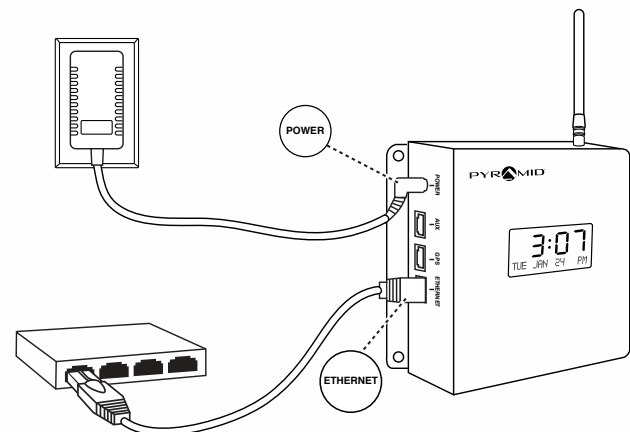

#### Simple Setup.

Simply plug the RF Wireless transmitter (sold separately) into a standard electrical outlet and Ethernet port to establish a network connection. Transmitter sends time signal to wall clocks.



Wireless



Synchronize



888.479.7264



info@pttime.com

pyramidtimesystems.com