



PCE Americas Inc.
711 Commerce Way
Suite 8
Jupiter
FL-33458
USA
From outside US: +1
Tel: (561) 320-9162
Fax: (561) 320-9176
info@pce-americas.com

PCE Instruments UK Ltd.
Units 12/13
Southpoint Business Park
Ensign way
Hampshire / Southampton
United Kingdom, SO31 4RF
From outside UK: +44
Tel: (0) 2380 98703 0
Fax: (0) 2380 98703 9
info@pce-instruments.com

www.pce-instruments.com/english
www.pce-instruments.com

Manual

Sound Level Meter

PCE-SDL 1





Contents

	Page
1.Safety Information	3
2.Functions Description.....	4
3.Specification.....	5
4.Name of Parts and Positions.....	6
5.Operating Instructions.....	7
6.Notice.....	7
7.Software Installation and Peration.....	8
8.Battery Replacement.....	11

1. Safety Information

Read the following safety information carefully before attempting to operate or service the meter.

Use the meter only as specified in this manual:

- Environment conditions
 - Altitude lower than 2000 meters
 - Relatively humidity $\leq 90\%RH$
 - Operation Ambient 0 to 40°C
- Maintenance & Clearing
 - Repair or servicing not covered in this manual should be performed by qualified personnel.
 - Periodically wipe the case with a dry cloth. Do not use solvents or eradicator on this instrument.
-  Safety symbols
-  Comply with EMC

2.Functions Description

This Sound Level Data Logger is designed for noise project; quality control; illness prevention and cure and all kinds of environmental sounds measurement. It is applied to the sounds measurement at factory; school; office; traffic access and household, etc.

- This unit conforms to the IEC61672-1 CLASS2 for Sound Level Meter.
- NORM (Normal) & PEAK mode
- Data manage: STORE, REAL TIME
- Over range indication
- A & C Weighting
- FAST & SLOW response
- Software Calibrate
- Manual & Automatic start mode

Note:

- In NORM mode, 20 data will be picked (one datum per 50ms) and the average value of the 20 data will be stored. At the same time, a PEAK MAX. & a PEAK MIN. will be picked within all the sampling data. If sampling rate > 10s, the periphery power will be off before reaching sampling time to save battery energy.
- In PEAK mode, DataLogger will always measure data with 50ms spacing. PEAK value means the MAX. and MIN. reading in the whole measurement but not the MAX. and MIN. in the sampling point. The stored sampling value is the MAX. in the sampling point of 20 sampling data but not the average.
- STORE: DataLogger sampling data at sampling point and store it to the datalogger memory
- REAL TIME: DataLogger sampling data at sampling point than send it to PC by the USB immediately, and the PC software will display the value

3.Specification

Standard Applied	IEC61672-1 CLASS2
Accuracy	± 1.4dB
Frequency Range	31.5Hz to 8kHz
Dynamic Range	50dB
Measure Range	30dB to 130dB
Data Memory	129920
Sampling Rate	1 second to 24 hours
Frequency Weighting	A and C
Time Weighting	FAST 125ms, SLOW 1 Second
Microphone	1/2 inch electret condenser microphone
Operating Indication	Green LED flash
Memory Full Indication	Yellow LED flash
Data Output	USB data traffic
Power	One 3.6V battery, specs:14250 or 1/2AAA
Electric Current	When measuring:5.5mA; when periphery power is off or stop measuring:30uA
Operation Temperature And Humidity	0 to 40°C (32 to 104°F) 10%RH to 90%RH
Storage Temperature And Humidity	-10 to 60°C (14 to 140°F) 10%RH to 75%RH
Dimension	130 x 30 x 25mm (5.1 x 1.1 x 0.9")
Weight	20g (1oz)
System Requirement	Windows 2000 / XP / Vista
Minimum Hardware Requirement	8M EMS memory, 2M hard disk,a free USB jack
Accessories	User manual, Battery, windscreen, CD Transparent cap

4.Name of Parts and Positions

- 1-Green LED
- 2-Red and Yellow LED
- 3-Button

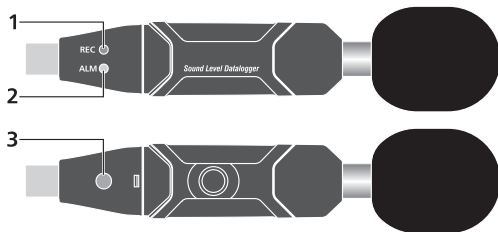

Led Flash Indication:

Single LED flash indication

Red LED: The sound level is over the alarm range.(flash 2 times quickly for high alarm,flash one time for low alarm)

Yellow LED: Memory full (10s/time)

Green LED: DataLogger normal working indication (cycle time can setup from the software)

Mixed flash

Red→Green→Yellow: DataLogger start to measure (automatic mode)

Green LED flash six times in 2 seconds: DataLogger start to measure (manual mode)

Green LED flash five times sequential: The datalogger reset

Red LED flash six times in 2 seconds: DataLogger stop measure (indication after operation manually stop)

Red and Yellow alternately: Download the data to PC

RED and Green LED flash simultaneous: low battery indication(10s/time) or manually stop dataLogger

5. Operating Instructions

- Setup the DataLogger by software before use it.
- Under the Manual mode, press and hold the button for 2s, DataLogger start to measure, and LED indicates the function at the same time. (see LED Flash Indication for details.)
- Under the Automatic mode, the DataLogger start to measure after setup in software, LED indicate the function at the same time. (see LED Flash Indication for details.)
- During measurement, the green LED indicates the working state by flashing with the frequency setup in the software.
- When datalogger memory full, it will stop recording and yellow LED will flash 10s/time.
- During measurement, when measured value exceeds the alarm range, the red LED will flash. (2 times-high alarm, one time-low alarm)
- As the battery power is not sufficient, the red and green LED will flash simultaneous 10s/time for indication.
- DataLogger data can be read time after time, the readings you are checking are the real time measured ones.(1 to 129920 readings)
- Without battery, the latest 1.5 hours (the most) data will be lost. Other data can be read in software after battery is installed.
- When replacing the battery, turn off the meter and open the battery cover. Then, replace the empty battery with a new 1/2AAA 3.6V battery and go for the cover.

6. Notice

- Do not store or operate the instrument at high temperature and high humidity environment.
- When not in use for long time, please take out the battery to avoid battery liquid leakage and cautery on the instrument
- When using the instrument in the presence of the wind, it is a must to mount the windscreen to not pick up undesired signals.
- Keep microphone dry and avoid severe vibration
- Without battery, the latest 1.5 hours (the most) data will be lost.
- You have to setup the DataLogger by software before use it.

7. Software Installation and Peration

- 7-1. Start windows
- 7-2. Insert the CD into the CD-ROM
- 7-3. Run "SETUP.EXE" installation program in file DISK1, install it to the directory of "C:\Program Files\Sound Datalogger\".
- 7-4. Setup the USB-driver
- 7-5. Plug the Datalogger to the USB port, system will find and install the USB-driver. Select the relevant Driver under the directory which the software installed in the step 3.
- 7-6. After Driver installation, a "USB I/O controlled devices" will appear in the Device Manager. You can find "Silabs C8051F320 USB Board" under this directory. Thus software and driver are installed.
- 7-7. Double click the icon "  " to start the software, then select "Instrument-DataLogger Setup" to set the sound level dtalogger. Click "setup" to read-in the setup information to the DataLogger.

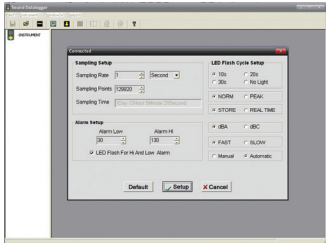

Samp Setup: Set the time of the sampling rate.(1 second to 24 hours)

Alarm Setup: Set the alarm function

LED Flash For Hi And Low Alarm: High and low alarm whether need the LED flash or not.

LED Flash Cycle Setup: The flash frequency of indicating LED

Manual/Automatic: Manual or Automatic mode

dBA/dBC: Weighting selection

FAST/SLOW: The Response time selection

NORM/PEAK: The metrical mode selection

SOTRE/REAL TIME: Data manage

7-8.Instrument-Download Data

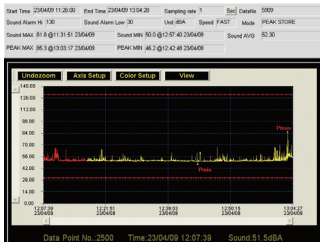

NORM Mode: Sound MAX/Sound MIN means the MAX degree or MIN degree of the sampling data. It is the average value of the 20 sampling data. PEAK MAX/PEAK MIN means the MAX or MIN degree of all the measuring values.(not the average value)

PEAK Mode: Sound MAX/Sound MIN means the MAX degree or MIN degree of the 20 sampling data.

PEAK MAX/PEAK MIN means the MAX or MIN degree of all the measuring values.

The yellow line show the datalogger is low battery.

7-9.Software Calibrate

When the microphone or the replacement of aging microphone lead to the the readings offset from standard value,then need for software calibration, click "  " The following window appears:

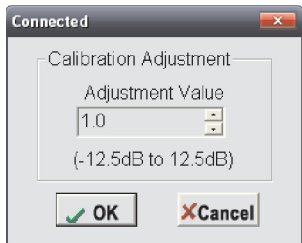

“Adjustment Value” is a Single calibration value, range: “-12.5” to “12.5”, value “1.0” means “1dB”. Assume the readings is 0.5dB higher than the standard value, “Adjustment Value” should be set to “-0.5”.

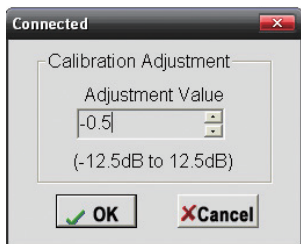

Click“OK”

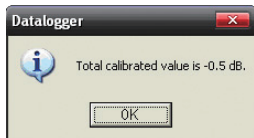

Return “Total calibrated value is -0.5 dB”, calibration over.
The range of the total calibrated value is from -12.5dB to 12.5dB.

7-10. Please view the Help file for specific plication of the software.

8. Battery Replacement

When the battery is low power you should replace the battery. Datalogger does not lose its stored readings when the battery is discharged or when the battery is replaced; the data logging process will however be stopped and cannot be re-started until the battery has been replaced and the logged data has been downloaded to PC. Only use 3.6V lithium batteries. Before replacing the battery, remove the model from the PC.

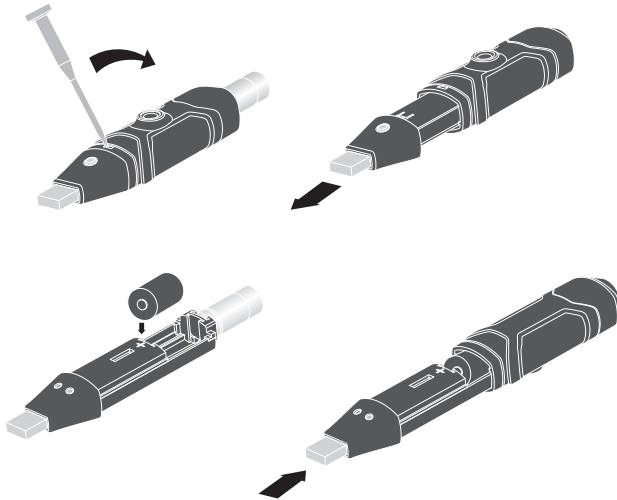

⚠ WARNING:
Handle lithium batteries carefully, observe warnings on battery casing.
Dispose of in accordance with local regulations.



Sound Level Data Logger User Manual

Rev.090701

