



**XDS2000 Dual-Channel Series  
Digital Storage Oscilloscopes  
User Manual**

**For product support, visit: [www.owon.com.hk/download](http://www.owon.com.hk/download)**

※: The illustrations, interface, icons and characters in the user manual may be slightly different from the actual product. Please refer to the actual product.

## **Sep. 2023 edition V1.1.2**

Copyright © LILLIPUT Company. All rights reserved.

The LILLIPUT's products are under the protection of the patent rights, including ones which have already obtained the patent rights and those which are applied for. The information in this manual will replace all materials published.

The information in this manual was correct at the time of printing. However, LILLIPUT will continue to improve products and reserves the rights to change specification at any time without notice.

**owon**<sup>®</sup> is the registered trademark of the LILLIPUT Company.

### **Fujian LILLIPUT Optoelectronics Technology Co., Ltd.**

No. 19, Heming Road

Lantian Industrial Zone, Zhangzhou 363005 P.R. China

**Tel:** +86-596-2130430

**Fax:** +86-596-2109272

**Web:** [www.owon.com](http://www.owon.com)

**E-mail:** [info@owon.com.cn](mailto:info@owon.com.cn)

# General Warranty

We warrant that the product will be free from defects in materials and workmanship for a period of 3 years from the date of purchase of the product by the original purchaser from our company. The warranty period for accessories such as probes. This warranty only applies to the original purchaser and is not transferable to a third party.

If the product proves defective during the warranty period, we will either repair the defective product without charge for parts and labour, or will provide a replacement in exchange for the defective product. Parts, modules and replacement products used by our company for warranty work may be new or reconditioned like new. All replaced parts, modules and products become the property of our company.

In order to obtain service under this warranty, the customer must notify our company of the defect before the expiration of the warranty period. Customer shall be responsible for packaging and shipping the defective product to the designated service centre, a copy of the customers proof of purchase is also required.

This warranty shall not apply to any defect, failure or damage caused by improper use or improper or inadequate maintenance and care. We shall not be obligated to furnish service under this warranty a) to repair damage resulting from attempts by personnel other than our company representatives to install, repair or service the product; b) to repair damage resulting from improper use or connection to incompatible equipment; c) to repair any damage or malfunction caused by the use of not our supplies; or d) to service a product that has been modified or integrated with other products when the effect of such modification or integration increases the time or difficulty of servicing the product.

Please contact the nearest Sales and Service Offices for services.

**Excepting the after-sales services provided in this summary or the applicable warranty statements, we will not offer any guarantee for maintenance definitely declared or hinted, including but not limited to the implied guarantee for marketability and special-purpose acceptability. We should not take any responsibilities for any indirect, special or consequent damages.**

# Table of Contents

<b>1. General Safety Requirements</b> .....	<b>1</b>
<b>2. Safety Terms and Symbols</b> .....	<b>2</b>
<b>3. Junior User Guidebook</b> .....	<b>4</b>
<b>Introduction to the Structure of the Oscilloscope</b> .....	<b>5</b>
Front Panel.....	5
Front Panel Menu Buttons .....	6
Rear Panel.....	6
Control Area .....	7
<b>User Interface Introduction</b> .....	<b>8</b>
<b>How to Implement the General Inspection</b> .....	<b>9</b>
<b>How to Implement the Function Inspection</b> .....	<b>10</b>
<b>How to Implement the Probe Compensation</b> .....	<b>11</b>
<b>How to Set the Probe Attenuation Coefficient</b> .....	<b>12</b>
<b>How to Use the Probe Safely</b> .....	<b>13</b>
<b>How to Implement Self-calibration</b> .....	<b>13</b>
<b>Introduction to the Vertical System</b> .....	<b>13</b>
<b>Introduction to the Horizontal System</b> .....	<b>15</b>
<b>Introduction to the Trigger System</b> .....	<b>15</b>
<b>Touchscreen Controls (Touchscreen is optional)</b> .....	<b>16</b>
Operate the Menu through Touchscreen .....	16
Gestures in Normal Mode .....	17
Gestures in Wave Zoom Mode .....	20
Other Operations Using Touchscreen .....	22
<b>4. Advanced User Guidebook</b> .....	<b>24</b>
<b>How to Set the Vertical System</b> .....	<b>25</b>
<b>Use Mathematical Manipulation Function</b> .....	<b>27</b>
Waveform math .....	28
User defined function .....	29
Digital Filter .....	29
Using FFT function .....	30
<b>Use Vertical Position and Scale Knobs</b> .....	<b>32</b>
<b>How to Set the Horizontal System</b> .....	<b>32</b>
Zoom the Waveform .....	33
<b>How to Set the Trigger/Decoding System</b> .....	<b>33</b>
Single Trigger .....	34
Alternate Trigger (Trigger mode: Edge).....	42
Bus Trigger .....	43
Bus Decoding.....	48

<b>How to Operate the Function Menu .....</b>	<b>52</b>
How to Implement Sampling Setup .....	53
How to Set the Display System .....	55
How to Save and Recall a Waveform .....	56
How to Record/Playback Waveforms .....	63
How to Clone a waveform .....	66
How to Implement the Auxiliary System Function Setting .....	69
How to Update your Instrument Firmware .....	73
How to Measure Automatically .....	74
How to customize an automatic measurement .....	79
How to Measure with Cursors .....	79
How to Use Autoscale .....	82
How to Use Built-in Help .....	84
How to Use Executive Buttons .....	84
How to Print the Screen Image .....	86
<b>5. Communication with PC .....</b>	<b>87</b>
<b>Using USB Port .....</b>	<b>87</b>
<b>Using LAN Port .....</b>	<b>88</b>
Connect directly .....	88
Connect through a router .....	89
<b>6. Demonstration .....</b>	<b>92</b>
<b>Example 1: Measurement a Simple Signal .....</b>	<b>92</b>
<b>Example 2: Gain of a Amplifier in a Metering Circuit .....</b>	<b>93</b>
<b>Example 3: Capturing a Single Signal .....</b>	<b>94</b>
<b>Example 4: Analyze the Details of a Signal .....</b>	<b>95</b>
<b>Example 5: Application of X-Y Function .....</b>	<b>97</b>
<b>Example 6: Video Signal Trigger .....</b>	<b>98</b>
<b>7. Troubleshooting .....</b>	<b>100</b>
<b>8. Technical Specifications .....</b>	<b>101</b>
Trigger .....	103
General Technical Specifications .....	106
<b>9. Appendix .....</b>	<b>107</b>
<b>Appendix A: Enclosure .....</b>	<b>107</b>
<b>Appendix B: General Care and Cleaning .....</b>	<b>107</b>

# 1. General Safety Requirements

Before use, please read the following safety precautions to avoid any possible bodily injury and to prevent this product or any other connected products from damage. In order to avoid any contingent danger, ensure this product is only used within the range specified.

Only the qualified technicians can implement the maintenance.

To avoid Fire or Personal Injury:

- **Connect the probe correctly. The grounding end of the probe corresponds to the grounding phase. Please don't connect the grounding end to the positive phase.**
- **Use Proper Power Cord.** Use only the power cord supplied with the product and certified to use in your country.
- **Connect or Disconnect Correctly.** When the probe or test lead is connected to a voltage source, please do not connect and disconnect the probe or test lead at random.
- **Product Grounded.** This instrument is grounded through the power cord grounding conductor. To avoid electric shock, the grounding conductor must be grounded. The product must be grounded properly before any connection with its input or output terminal.

**When powered by AC power, it is not allowed to measure AC power source directly, because the testing ground and power cord ground conductor are connected together, otherwise, it will cause short circuit.**

- **Check all Terminal Ratings.** To avoid fire or shock hazard, check all ratings and markers of this product. Refer to the user's manual for more information about ratings before connecting to the instrument.
- **Do not operate without covers.** Do not operate the instrument with covers or panels removed.
- **Use Proper Fuse.** Use only the specified type and rating fuse for this instrument.
- **Avoid exposed circuit.** Do not touch exposed junctions and components when the instrument is powered.
- **Do not operate if in any doubt.** If you suspect damage occurs to the instrument, have it inspected by qualified service personnel before further operations.
- **Use your Oscilloscope in a well-ventilated area.** Make sure the instrument installed with proper ventilation, refer to the user manual for more details.
- **Do not operate in wet conditions.**
- **Do not operate in an explosive atmosphere.**
- **Keep product surfaces clean and dry.**

## 2. Safety Terms and Symbols

### Safety Terms

**Terms in this manual.** The following terms may appear in this manual:



**Warning:** Warning indicates the conditions or practices that could result in injury or loss of life.



**Caution:** Caution indicates the conditions or practices that could result in damage to this product or other property.

**Terms on the product.** The following terms may appear on this product:

**Danger:** It indicates an injury or hazard may immediately happen.

**Warning:** It indicates an injury or hazard may be accessible potentially.

**Caution:** It indicates a potential damage to the instrument or other property might occur.

### Safety Symbols

**Symbols on the product.** The following symbol may appear on the product:



Hazardous Voltage



Refer to Manual



Protective Earth Terminal



Chassis Ground



Test Ground

To avoid body damage and prevent product and connected equipment damage, carefully read the following safety information before using the test tool. This product can only be used in the specified applications.



**Warning:**

**The two channels of the oscilloscope are not electrically isolated. The channels should adopt a common ground during measuring. To prevent short circuits, the 2 probe grounds must not be connected to 2 different non-isolated DC levels.**

**The diagram of the oscilloscope ground wire connection:**

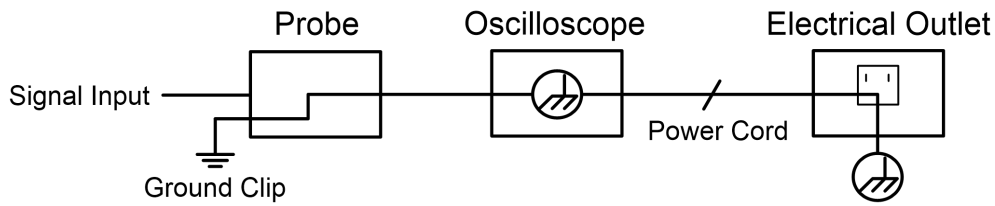

**It is not allowed to measure AC power when the oscilloscope is AC powered.**

**⚠ Warning:**

**To avoid fire or electrical shock, when the oscilloscope input signal connected is more than 42V peak (30Vrms) or on circuits of more than 4800VA, please take note of below items:**

- **Only use accessory insulated voltage probes and test lead.**
- **Check the accessories such as probe before use and replace it if there are any damages.**
- **Remove probes, test leads and other accessories immediately after use.**
- **Remove USB cable which connects oscilloscope and computer.**
- **Do not apply input voltages above the rating of the instrument because the probe tip voltage will directly transmit to the oscilloscope. Use with caution when the probe is set as 1:1.**
- **Do not use exposed metal BNC or banana plug connectors.**
- **Do not insert metal objects into connectors.**



## **3. Junior User Guidebook**

**This chapter deals with the following topics mainly:**

- Introduction to the structure of the oscilloscope
- Introduction to the user interface
- How to implement the general inspection
- How to implement the function inspection
- How to make a probe compensation
- How to set the probe attenuation coefficient
- How to use the probe safely
- How to implement an auto-calibration
- Introduction to the vertical system
- Introduction to the horizontal system
- Introduction to the trigger system
- Touchscreen Controls (Touchscreen is optional)

## Introduction to the Structure of the Oscilloscope

This chapter makes a simple description of the operation and function of the front panel of the oscilloscope, enabling you to be familiar with the use of the oscilloscope in the shortest time.

### Front Panel

The front panel has knobs and function buttons. The 5 buttons in the column on the right side of the display screen or in the row under the display screen are menu selection buttons, through which, you can set the different options for the current menu. The other buttons are function buttons, through which, you can enter different function menus or obtain a specific function application directly.

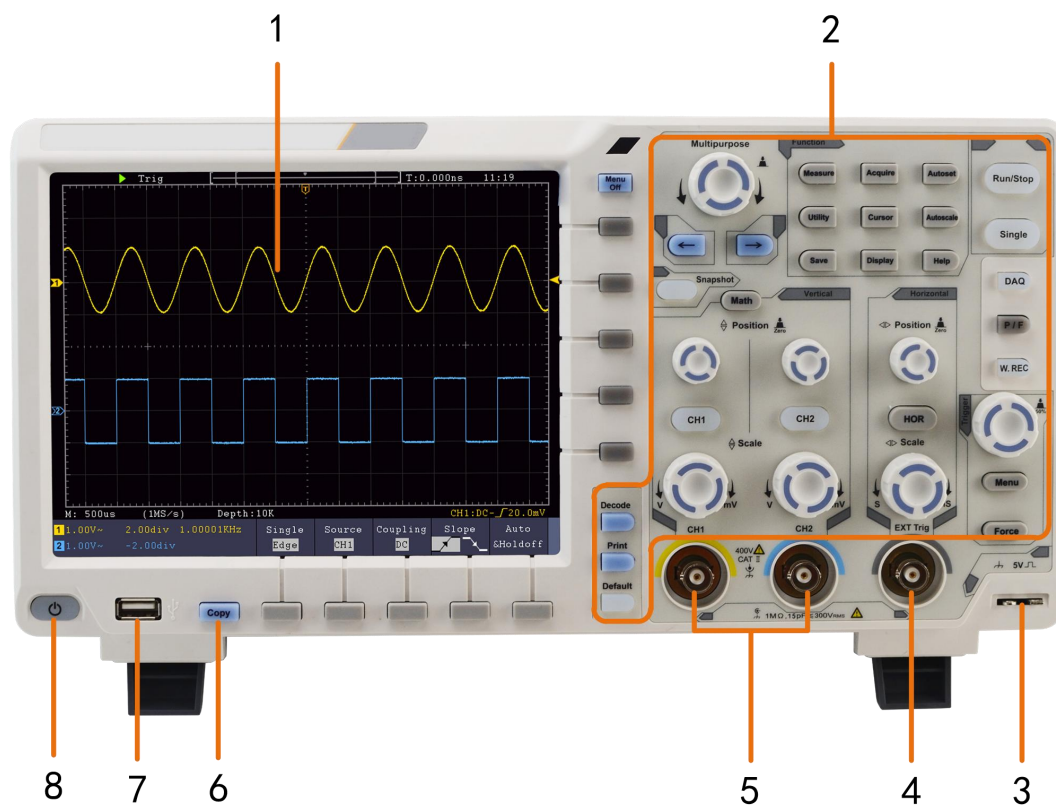

Figure 3- 1 Front panel

1. Display area.
2. Control (button and knob) area.
3. Probe Compensation: Measurement signal ( $\approx 5V/1kHz$ ) output.
4. EXT Trigger Input.
5. Signal Input Channel.
6. Copy button: You can save the waveform by just pressing this button in any user interface.
7. **USB Host port:** It is used to transfer data when external USB equipment connects to the oscilloscope regarded as "host device". For example: Saving the waveform to USB flash disk needs to use this port.

8. Power on/off

Backlight of this button:

**Red light:** The oscilloscope is turned off (connects with AC Power);

**Green light:** The oscilloscope is turned on (powered by AC Power).

### Front Panel Menu Buttons

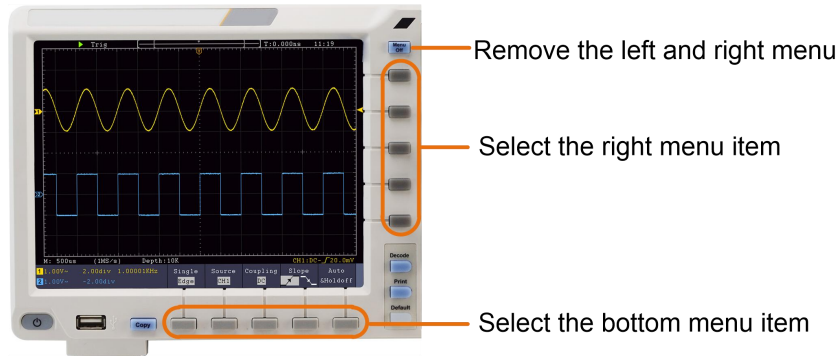

Figure 3-2 Menu Buttons

### Rear Panel

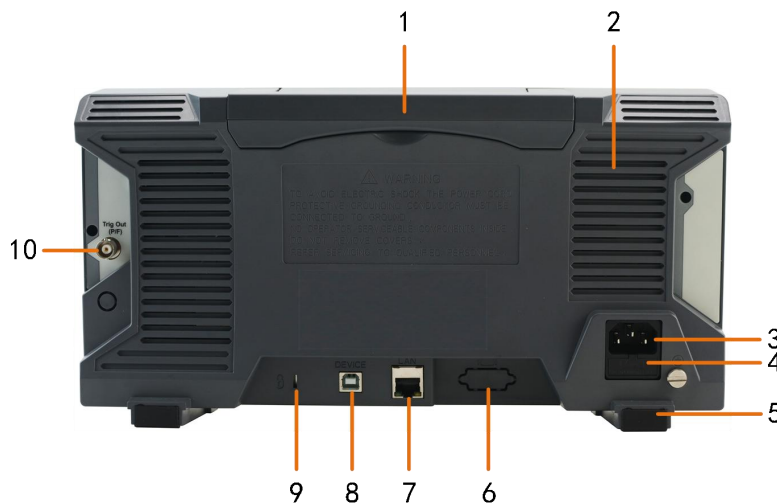

Figure 3-3 Rear Panel

1. Handle.
2. Air vents.
3. AC power input jack.
4. Fuse.
5. **Foot stool:** Adjust the tilt angle of the oscilloscope.
6. **VGA port:** To connect the oscilloscope with a monitor or a projector as VGA output (optional).
7. **LAN port:** the network port which can be used to connect with PC.
8. **USB Device port:** It is used to transfer data when external USB equipment connects to the oscilloscope regarded as "slave device". For example: to use this port when connect PC to the oscilloscope by USB.
9. **Lock Hole:** You can lock the oscilloscope to a fixed location using the security lock (please buy it yourself) to secure the oscilloscope.

10. **Trig Out(P/F)** port: Trigger signal output or Pass/Fail output.

## Control Area

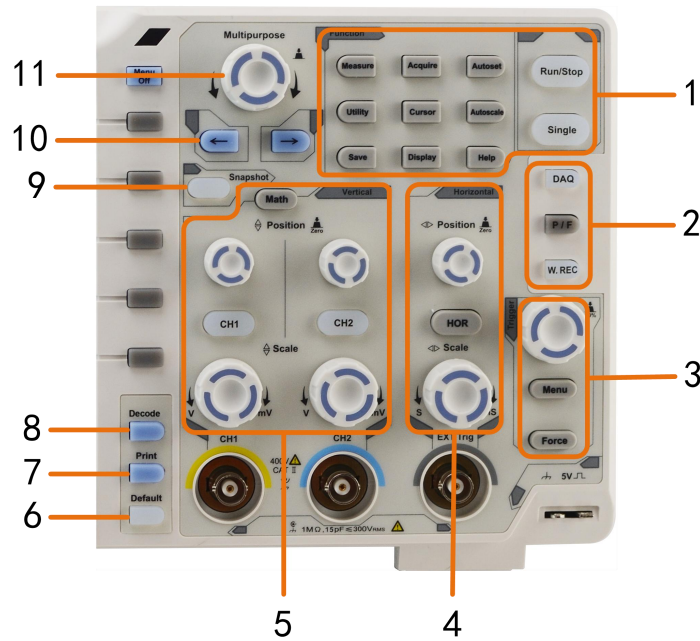

Figure 3-4 Control Area Overview

1. **Function button area:** Total 11 buttons.
2. **DAQ:** Recorder (This function is not available in XDS2000 series.)  
**P/F:** Pass/Fail;  
**W.REC:** Waveform Record.
3. **Trigger control area** with 2 buttons and 1 knob.  
 The Trigger Level knob is to adjust trigger voltage. Other 2 buttons refer to trigger system setting.
4. **Horizontal control area** with 1 button and 2 knobs.  
 "HOR" button refer to horizontal system setting menu, "Horizontal Position" knob control trigger position, "Horizontal Scale" control time base.
5. **Vertical control area** with 3 buttons and 4 knobs.  
 "CH1" and "CH2 " correspond to setting menu in CH1 and CH2, "Math" button refer to math menu, the math menu consists of six kinds of operations, including CH1-CH2, CH2-CH1, CH1+CH2, CH1\*CH2, CH1/CH2 and FFT. Two "Vertical Position" knob control the vertical position of CH1/CH2, and two "Scale" knob control voltage scale of CH1, CH2.
6. **Default:** Call out the factory settings.
7. **Print.**
8. Turn on/off **Decode** function.
9. **Snapshot.**
10. **Direction key:** Move the cursor of the focused parameter.

11. **M knob** (Multipurpose knob): when a **M** symbol appears in the menu, it indicates you can turn the **M** knob to select the menu or set the value. You can push it to close the menu on the left and right.

## User Interface Introduction

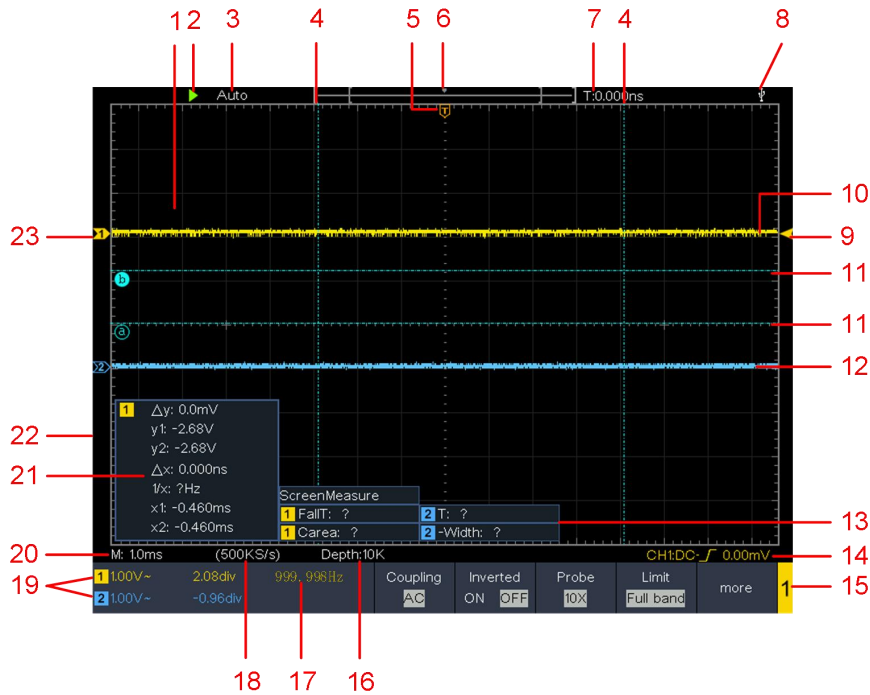



Figure 3-5 Illustrative Drawing of Display Interfaces

1. Waveform Display Area.
2. Run/Stop.
3. The state of trigger, including:
  - Auto: Automatic mode and acquire waveform without triggering.
  - Trig: Trigger detected and acquire waveform.
  - Ready: Pre-triggered data captured and ready for a trigger.
  - Scan: Capture and display the waveform continuously.
  - Stop: Data acquisition stopped.
4. The two blue dotted lines indicates the vertical position of cursor measurement.
5. The T pointer indicates the horizontal position for the trigger.
6. The pointer indicates the trigger position in the record length.
7. It shows present triggering value and displays the site of present window in internal memory.
8. It indicates that there is a USB disk connecting with the oscilloscope.
9. The pointer shows the trigger level position.
10. The waveform of CH1.
11. The two blue dotted lines indicate the horizontal position of cursor measurement.

12. The waveform of CH2.
13. It indicates the measured type and value of the corresponding channel. "T" means period, "F" means frequency, "V" means the average value, "Vp" the peak-peak value, "Vr" the root-mean-square value, "Ma" the maximum amplitude value, "Mi" the minimum amplitude value, "Vt" the Voltage value of the waveform's flat top value, "Vb" the Voltage value of the waveform's flat base, "Va" the amplitude value, "Os" the overshoot value, "Ps" the Preshoot value, "RT" the rise time value, "FT" the fall time value, "PW" the +width value, "NW" the -Width value, "+D" the +Duty value, "-D" the -Duty value, "PD" the Delay A->B  $\Phi$  value, "ND" the Delay A->B  $\Psi$  value, "TR" the Cycle RMS, "CR" the Cursor RMS, "WP" the Screen Duty, "FRR" the FRR, "FRF" the FRF, "FFR" the FFR, "FFF" the FFF, "LRR" the, "LRF" the LRF, "LFR" the LFR, "LFF" the LFF, "RP" the Phase, "+PC" the +Pulse count, "-PC" the - Pulse count, "+E" the Rise edge count, "-E" the Fall edge count, "AR" the Area, "CA" the Cycle area.
14. The icon shows the selected trigger type, e.g.  represents triggering on the rising edge for an Edge trigger. The reading shows the trigger level value of the corresponding channel.
15. Channel identifier of current bottom menu.
16. The readings show the record length.
17. The frequency of the trigger signal.
18. The readings show current sample rate.
19. The readings indicate the corresponding Voltage Division and the Zero Point positions of the channels. "BW" indicates bandwidth limit.  
The icon shows the coupling mode of the channel.  
"—" indicates direct current coupling  
"~" indicates AC coupling  
" $\equiv$ " indicates GND coupling
20. The reading shows the setting of main time base.
21. It is cursor measure window, showing the absolute values and the readings of the cursors.
22. The blue pointer shows the grounding datum point (zero point position) of the waveform of the CH2 channel. If the pointer is not displayed, it means that this channel is not opened.
23. The yellow pointer indicates the grounding datum point (zero point position) of the waveform of the CH1 channel. If the pointer is not displayed, it means that the channel is not opened.

## How to Implement the General Inspection

After you get a new oscilloscope, it is recommended that you should make a check on the instrument according to the following steps:

1. Check whether there is any damage caused by transportation.

If it is found that the packaging carton or the foamed plastic protection cushion has suffered serious damage, do not throw it away first till the complete device and its accessories succeed in the electrical and mechanical property tests.

#### 2. Check the Accessories

The supplied accessories have been already described in the "Appendix A: Enclosure" of this Manual. You can check whether there is any loss of accessories with reference to this description. If it is found that there is any accessory lost or damaged, please get in touch with our distributor responsible for this service or our local offices.

#### 3. Check the Complete Instrument

If it is found that there is damage to the appearance of the instrument, or the instrument can not work normally, or fails in the performance test, please get in touch with our distributor responsible for this business or our local offices. If there is damage to the instrument caused by the transportation, please keep the package. With the transportation department or our distributor responsible for this business informed about it, a repairing or replacement of the instrument will be arranged by us.

## How to Implement the Function Inspection

Make a fast function check to verify the normal operation of the instrument, according to the following steps:

1. **Connect the power cord to a power source. Long press the  button on the bottom left of the instrument.**

The instrument carries out all self-check items and shows the Boot Logo. Push the **Utility** button, select **Function** in the bottom menu. Select **Adjust** in the left menu, select **Default** in the bottom menu. The default attenuation coefficient set value of the probe in the menu is 10X.

2. **Set the Switch in the Oscilloscope Probe as 10X and Connect the Oscilloscope with CH1 Channel.**

Align the slot in the probe with the plug in the CH1 connector BNC, and then tighten the probe with rotating it to the right side.

Connect the probe tip and the ground clamp to the connector of the probe compensator.

3. **Push the Autoset Button on the front panel.**

The square wave of 1 KHz frequency and  $\approx 5V$  peak-peak value will be displayed in several seconds (see *Figure 3- 6*).

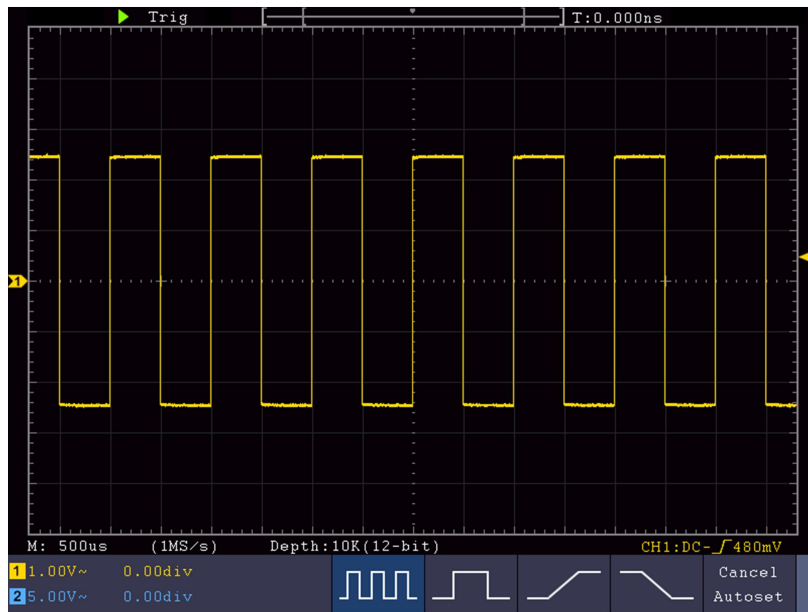

Figure 3-6 Auto set

Check CH2 by repeating Step 2 and Step 3.

## How to Implement the Probe Compensation

When connect the probe with any input channel for the first time, make this adjustment to match the probe with the input channel. The probe which is not compensated or presents a compensation deviation will result in the measuring error or mistake. For adjusting the probe compensation, please carry out the following steps:

1. Set the attenuation coefficient of the probe in the menu as 10X and that of the switch in the probe as 10X (see "*How to Set the Probe Attenuation Coefficient*" on P12), and connect the probe with the CH1 channel. If a probe hook tip is used, ensure that it keeps in close touch with the probe. Connect the probe tip with the signal connector of the probe compensator and connect the reference wire clamp with the ground wire connector of the probe connector, and then push the **Autoset** button on the front panel.
2. Check the displayed waveforms and regulate the probe till a correct compensation is achieved (see *Figure 3-7* and *Figure 3-8*).

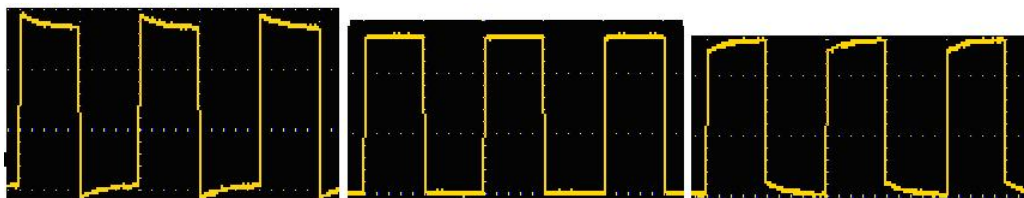

**Overcompensated**

**Compensated correctly**

**Under compensated**

Figure 3-7 Displayed Waveforms of the Probe Compensation

3. Repeat the steps mentioned if needed.



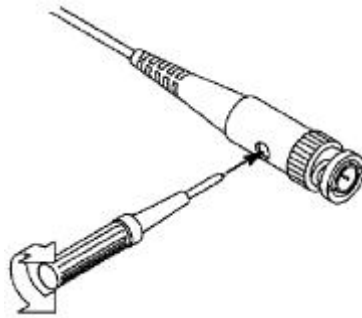

Figure 3-8 Adjust Probe

## How to Set the Probe Attenuation Coefficient

The probe has several attenuation coefficients, which will influence the vertical scale factor of the oscilloscope.

To change or check the probe attenuation coefficient in the menu of oscilloscope:

- (1) Push the function menu button of the used channels (**CH1** or **CH2 button**).
- (2) Select **Probe** in the bottom menu; select **Attenu** in the right menu, turn the **M** knob to select the proper value corresponding to the probe.

This setting will be valid all the time before it is changed again.



### Caution:

The default attenuation coefficient of the probe on the instrument is preset to 10X.

Make sure that the set value of the attenuation switch in the probe is the same as the menu selection of the probe attenuation coefficient in the oscilloscope.

---

The set values of the probe switch are 1X and 10X (see *Figure 3-9*).

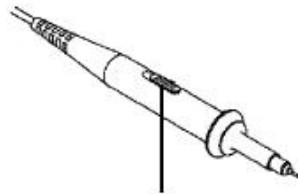

Figure 3-9 Attenuation Switch



### Caution:

When the attenuation switch is set to 1X, the probe will limit the bandwidth of the oscilloscope in 5MHz. To use the full bandwidth of the oscilloscope, the switch must be set to 10X.

---

## Identify the Probe Attenuation Coefficient Automatically

The oscilloscope can identify the probe attenuation coefficient of the 100:1 (impedance  $5K \pm 20\%$ ) or 10:1 (impedance  $10K \pm 20\%$ ) probe with the identifying pin. When you

attach the probe, the oscilloscope set the attenuation automatically on the oscilloscope vertical menu for the channel to match the probe.

For example, if you attach a 10:1 probe with the identifying pin, the screen will prompt "The probe attenuation factor is 10X", and set the attenuation to 10X automatically on the oscilloscope vertical menu for the channel.

## How to Use the Probe Safely

The safety guard ring around the probe body protects your finger against any electric shock, shown as *Figure 3-10*.

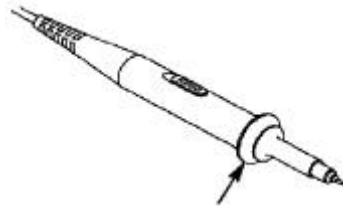

Figure 3-10 Finger Guard



### Warning:

To avoid electric shock, always keep your finger behind the safety guard ring of the probe during the operation.

To protect you from suffering from the electric shock, do not touch any metal part of the probe tip when it is connected to the power supply.

Before making any measurements, always connect the probe to the instrument and connect the ground terminal to the earth.

---

## How to Implement Self-calibration

The self-calibration application can make the oscilloscope reach the optimum condition rapidly to obtain the most accurate measurement value. You can carry out this application program at any time. This program must be executed whenever the change of ambient temperature is 5°C or over.

Before performing a self-calibration, disconnect all probes or wires from the input connector. Push the **Utility** button, select **Function** in the bottom menu, select **Adjust.** in the left menu, select **Self Cal** in the bottom menu; run the program after everything is ready.

## Introduction to the Vertical System

As shown in *Figure 3-11*, there are a few of buttons and knobs in **Vertical Controls**. The following practices will gradually direct you to be familiar with the using of the vertical setting.



Figure 3- 11 Vertical Control Zone

1. Use the **Vertical Position** knob to show the signal in the center of the waveform window. The **Vertical Position** knob functions the regulating of the vertical display position of the signal. Thus, when the **Vertical Position** knob is rotated, the pointer of the earth datum point of the channel is directed to move up and down following the waveform.

### Measuring Skill

If the channel is under the DC coupling mode, you can rapidly measure the DC component of the signal through the observation of the difference between the waveform and the signal ground.

If the channel is under the AC mode, the DC component would be filtered out. This mode helps you display the AC component of the signal with a higher sensitivity.

### Vertical offset back to 0 shortcut key

Turn the **Vertical Position** knob to change the vertical display position of channel and push the position knob to set the vertical display position back to 0 as a shortcut key, this is especially helpful when the trace position is far out of the screen and want it to get back to the screen center immediately.

2. Change the Vertical Setting and Observe the Consequent State Information Change.

With the information displayed in the status bar at the bottom of the waveform window, you can determine any changes in the channel vertical scale factor.

- Turn the **Vertical Scale** knob and change the "Vertical Scale Factor (Voltage Division)", it can be found that the scale factor of the channel corresponding to the status bar has been changed accordingly.
- Push buttons of **CH1**, **CH2** and **Math**, the operation menu, symbols, waveforms and scale factor status information of the corresponding channel will be displayed in the screen.

## Introduction to the Horizontal System

Shown as *Figure 3-12*, there are a button and two knobs in the **Horizontal Controls**. The following practices will gradually direct you to be familiar with the setting of horizontal time base.



Figure 3-12 Horizontal Control Zone

1. Turn the **Horizontal Scale** knob to change the horizontal time base setting and observe the consequent status information change. Turn the **Horizontal Scale** knob to change the horizontal time base, and it can be found that the **Horizontal Time Base** display in the status bar changes accordingly.
2. Use the **Horizontal Position** knob to adjust the horizontal position of the signal in the waveform window. The **Horizontal Position** knob is used to control the triggering displacement of the signal or for other special applications. If it is applied to triggering the displacement, it can be observed that the waveform moves horizontally with the knob when you rotate the **Horizontal Position** knob.

### Triggering displacement back to 0 shortcut key

Turn the **Horizontal Position** knob to change the horizontal position of channel and push the **Horizontal Position** knob to set the triggering displacement back to 0 as a shortcut key.

3. Push the **Horizontal HOR** button to switch between the normal mode and the wave zoom mode.

## Introduction to the Trigger System

As shown in *Figure 3-13*, there are one knob and three buttons make up **Trigger Controls**. The following practices will direct you to be familiar with the setting of the trigger system gradually.





Figure 3- 13 Trigger Control Zone

1. Push the **Trigger Menu** button and call out the trigger menu. With the operations of the menu selection buttons, the trigger setting can be changed.
2. Use the **Trigger Level** knob to change the trigger level setting. By turning the **Trigger Level** knob, the trigger indicator in the screen will move up and down. With the movement of the trigger indicator, it can be observed that the trigger level value displayed in the screen changes accordingly.  
**Note:** Turning the **Trigger Level** knob can change trigger level value and it is also the hotkey to set trigger level as the vertical mid point values of the amplitude of the trigger signal.
3. Push the **Force** button to force a trigger signal, which is mainly applied to the "Normal" and "Single" trigger modes.

## Touchscreen Controls (Touchscreen is optional)

If the LCD is touchscreen, you can control the oscilloscope by different gestures.

The touchable icon at the top right of the screen is used to enable (  ) or disable (  ) the touchscreen controls.

The instruction of touchscreen controls is as below. You can also use the buttons / knobs enclosed in brackets to do the same thing.

### Operate the Menu through Touchscreen

- **Select a menu item:** Touch the menu items in the bottom menu, or in the right menu, or in the left menu.
- **Switch menu items:** If there are options that can be switched in the menu, you can repeatedly touch the area of the menu item to switch, or push the corresponding button to switch. See figure below:



Press repeatedly to  
switch the options

- **Scroll the list:** If there is a scroll bar in the left menu or in the file system window, you can swipe up and down to scroll the list.

- **Touchable menu pane:** Click the  icon on the left top of the display area, a menu pane will be shown. Clicking the menu item is same as pushing the corresponding button.

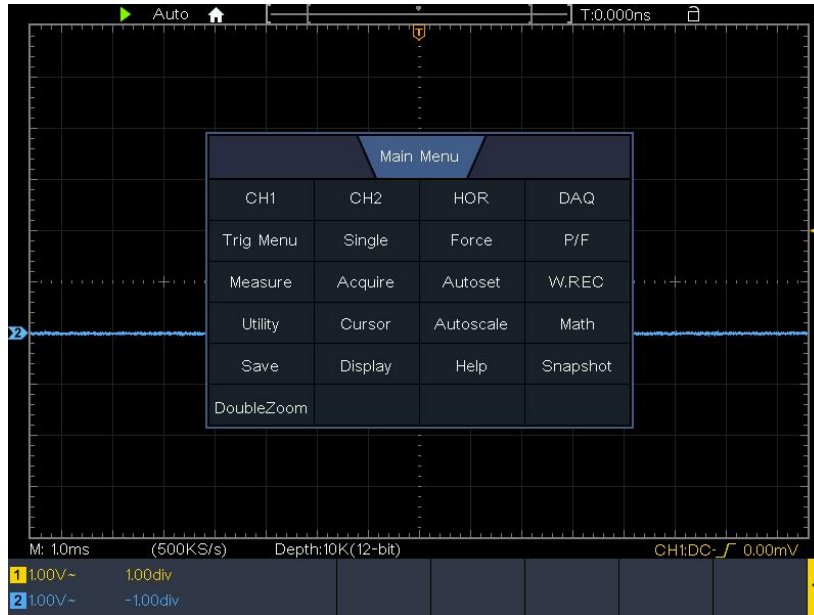

## Gestures in Normal Mode

- **Select a channel (CH1 or CH2 button):** Touch the pointer on the left side of corresponding channel to make it in selected state.
- **Set the vertical position of the selected channel (Vertical Position knob):** Swipe up or down on the screen.

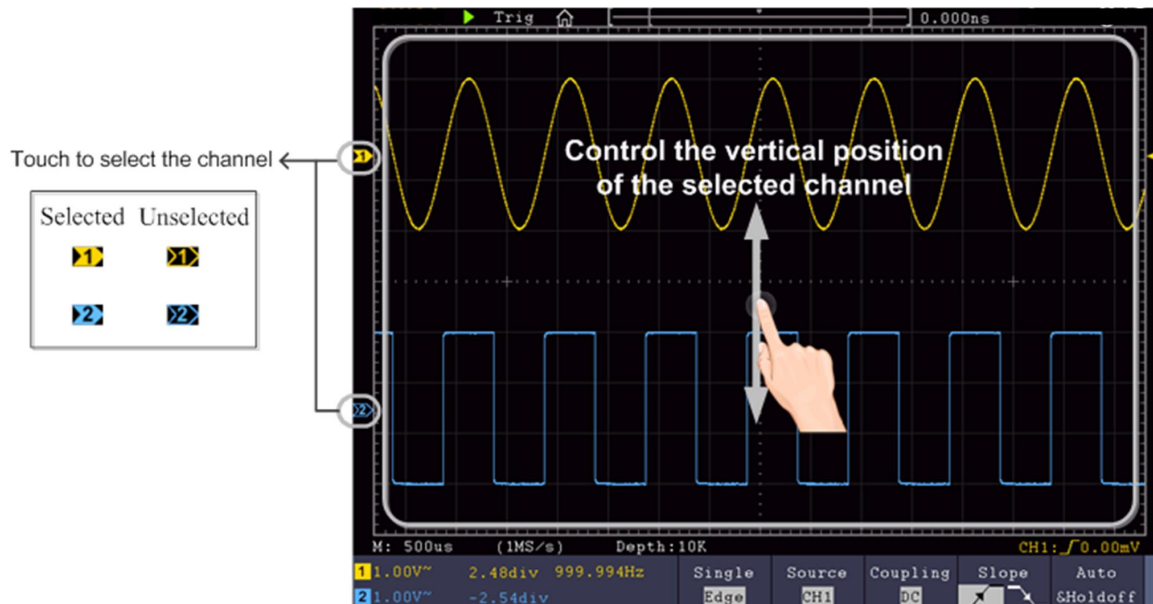

- **Set the trigger level of the source in trigger menu (Trigger Level knob):** Swipe up or down on the area nearby the trigger pointer on the right.

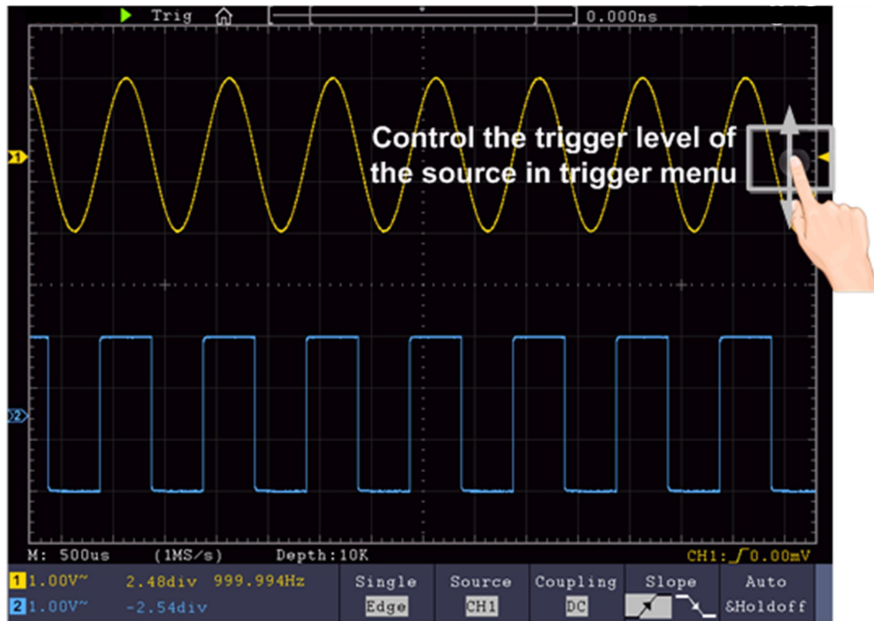

- Set the horizontal position (Horizontal Position knob): Swipe left or right on the display area.

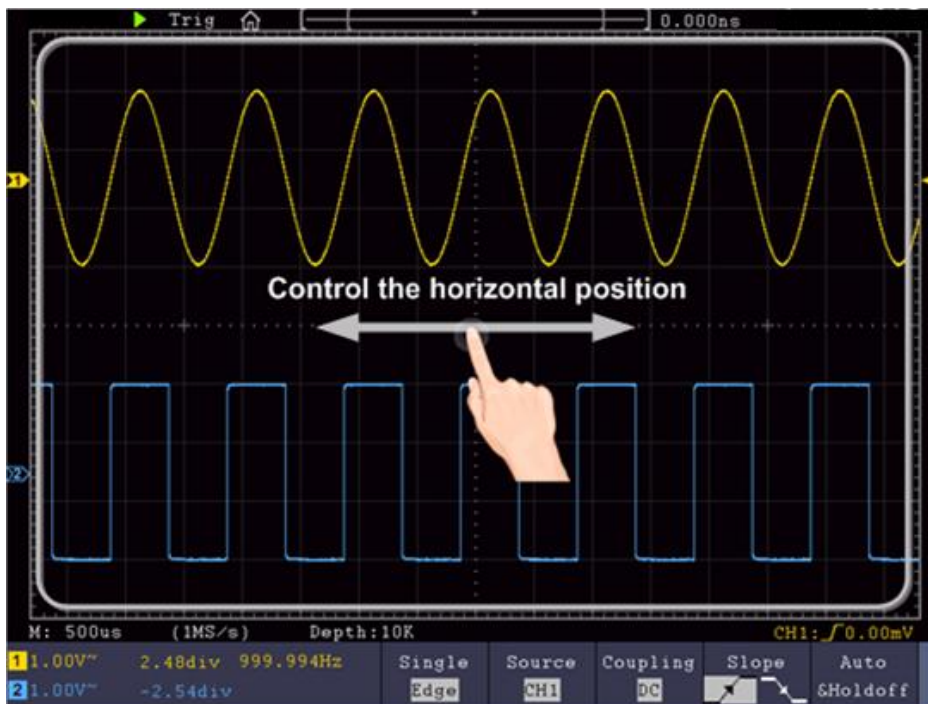

### Double Zoom and Single Zoom

In touchable menu pane, if **DoubleZoom** is selected, in the display area, pinch and spread horizontally to change the time base; pinch and spread vertically to change the voltage division of current channel.

Main Menu			
CH1	CH2	HOR	DAQ
Trig Menu	Single	Force	P/F
Measure	Acquire	Autoset	W.REC
Utility	Cursor	Autoscale	Math
Save	Display	Help	Snapshot
DoubleZoom			

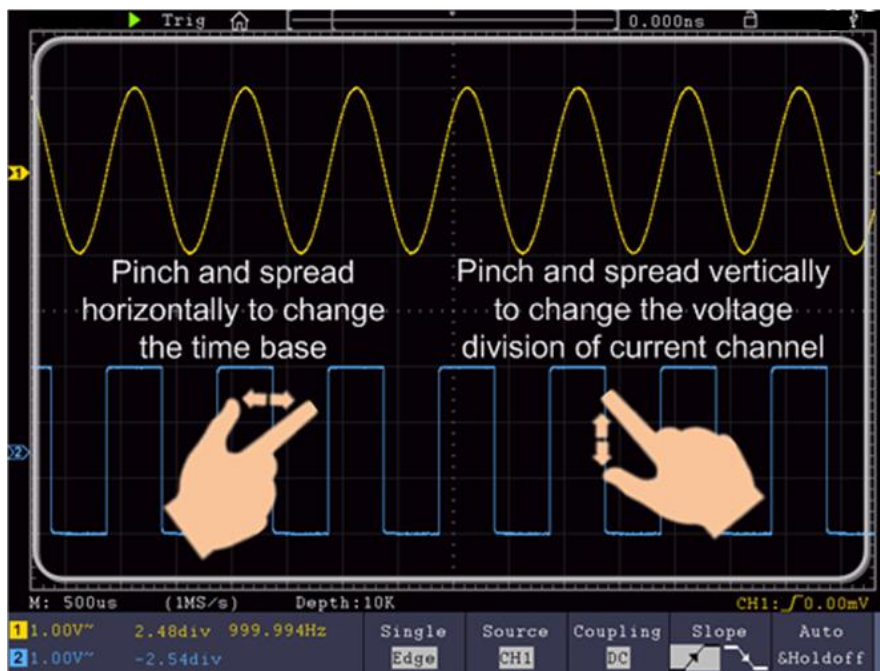

In touchable menu pane, if **SingleZoom** is selected, click anywhere on the Display area to show the touching control panel.

Main Menu			
CH1	CH2	HOR	DAQ
Trig Menu	Single	Force	P/F
Measure	Acquire	Autoset	W.REC
Utility	Cursor	Autoscale	Math
Save	Display	Help	Snapshot
SingleZoom			



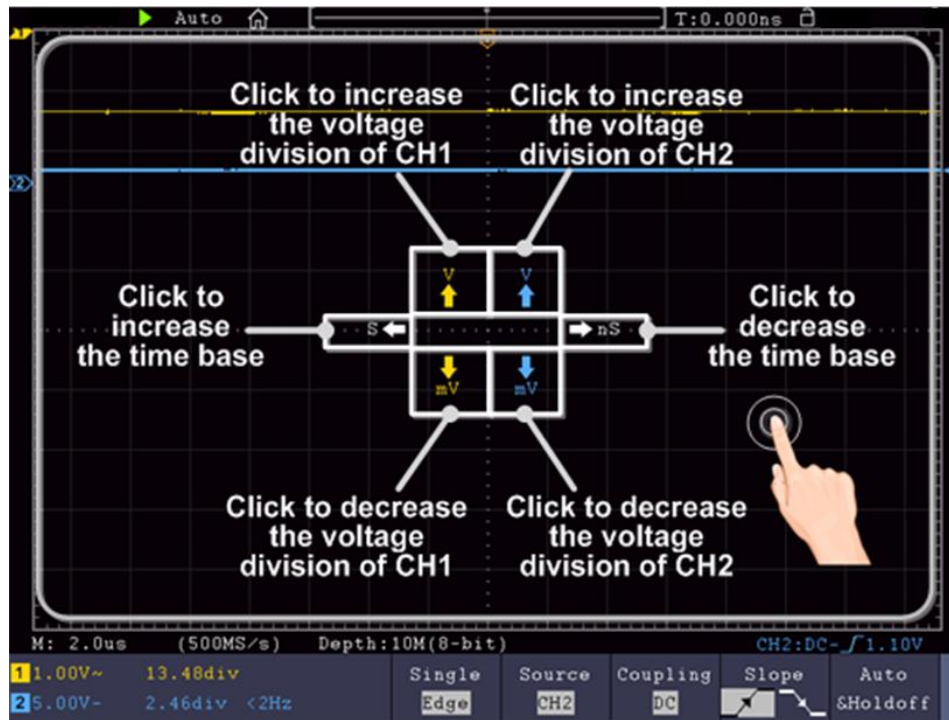

- **Set the voltage division (Vertical Scale knob):** Click on the left upper area to increase the voltage division of CH1; click on the left lower area to decrease the voltage division of CH1. Click on the right upper area to increase the voltage division of CH2; click on the right lower area to decrease the voltage division of CH2.
- **Set the horizontal time base (Horizontal Scale knob):** Click on the left area to increase the voltage division; click on the right area to decrease the voltage division.

## Gestures in Wave Zoom Mode

Push the **Horizontal HOR** button to enter into zoom mode. The top half of the display shows the Main window and the bottom half displays the Zoom window. The Zoom window is a magnified portion of the Main window.

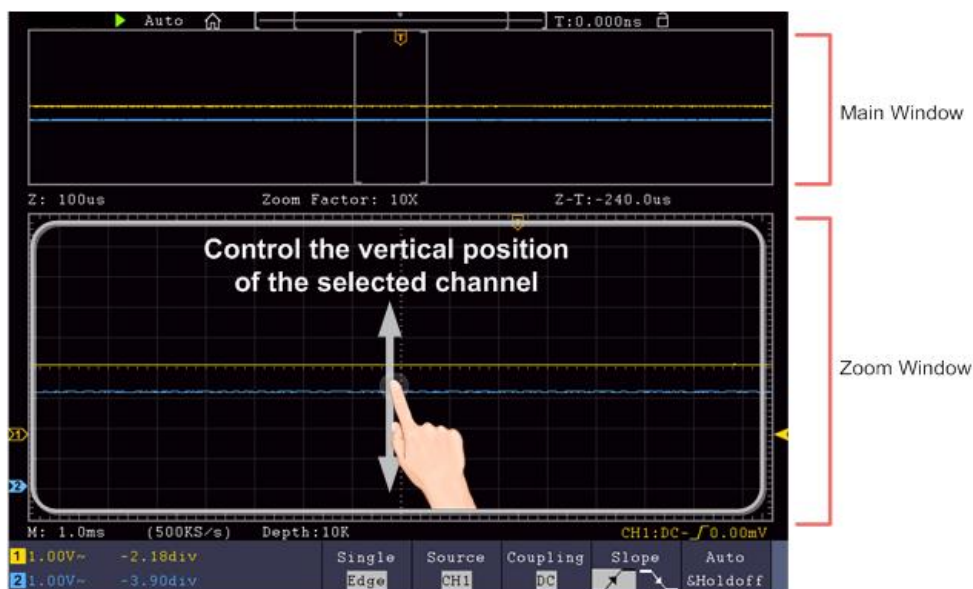

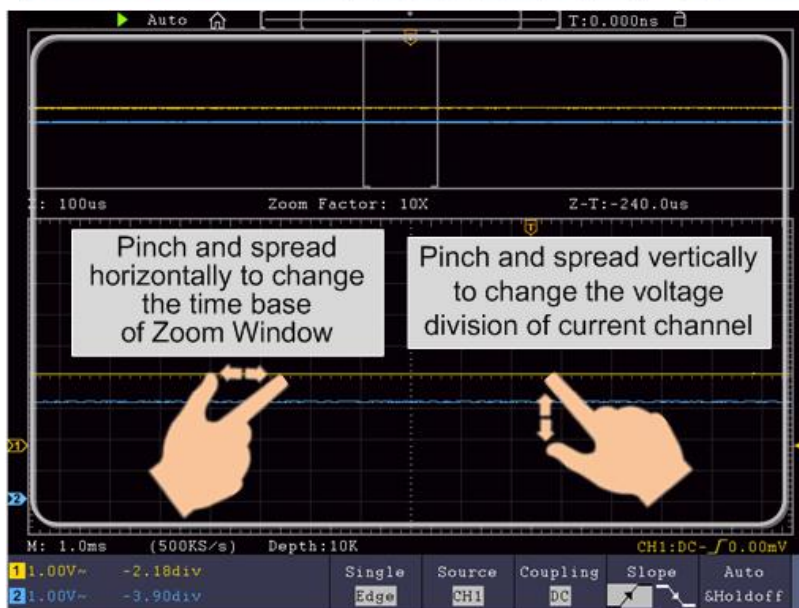
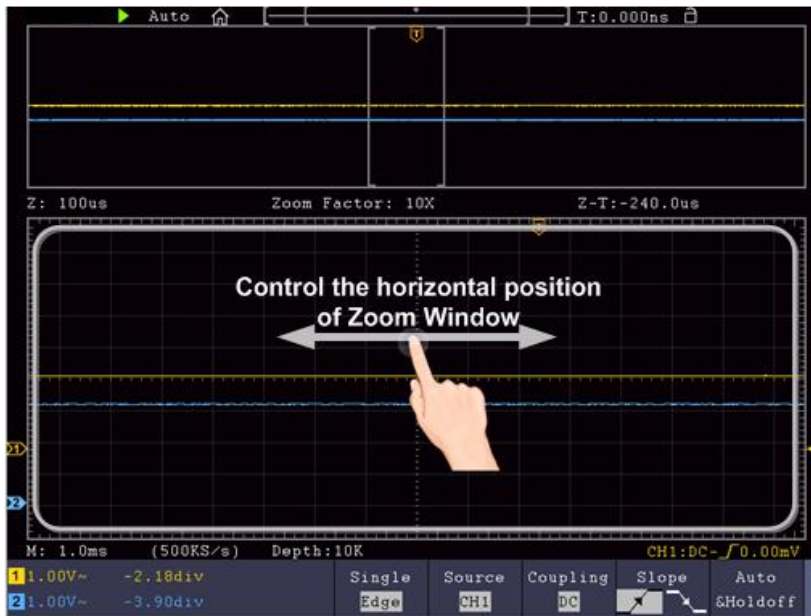
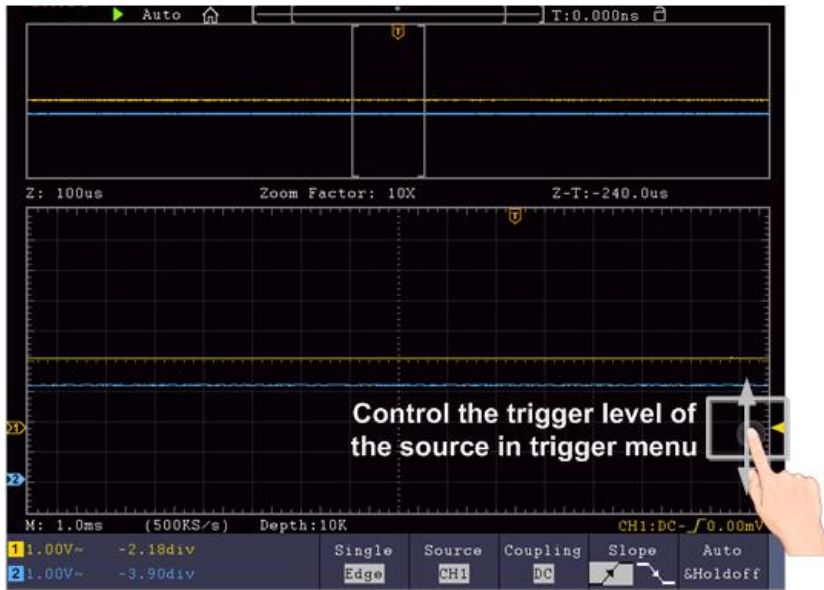

(Double Zoom)

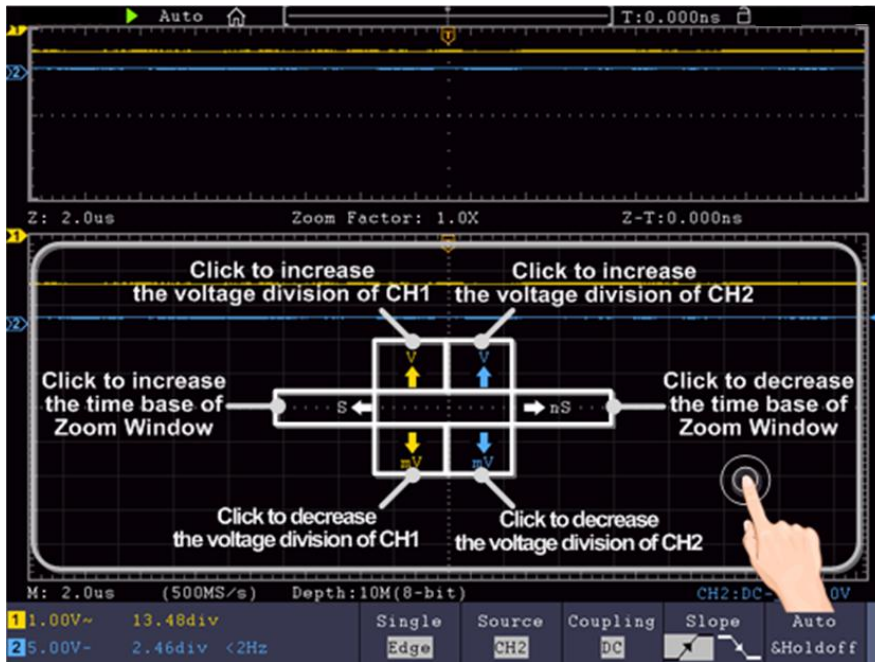



(Single Zoom)

## Other Operations Using Touchscreen

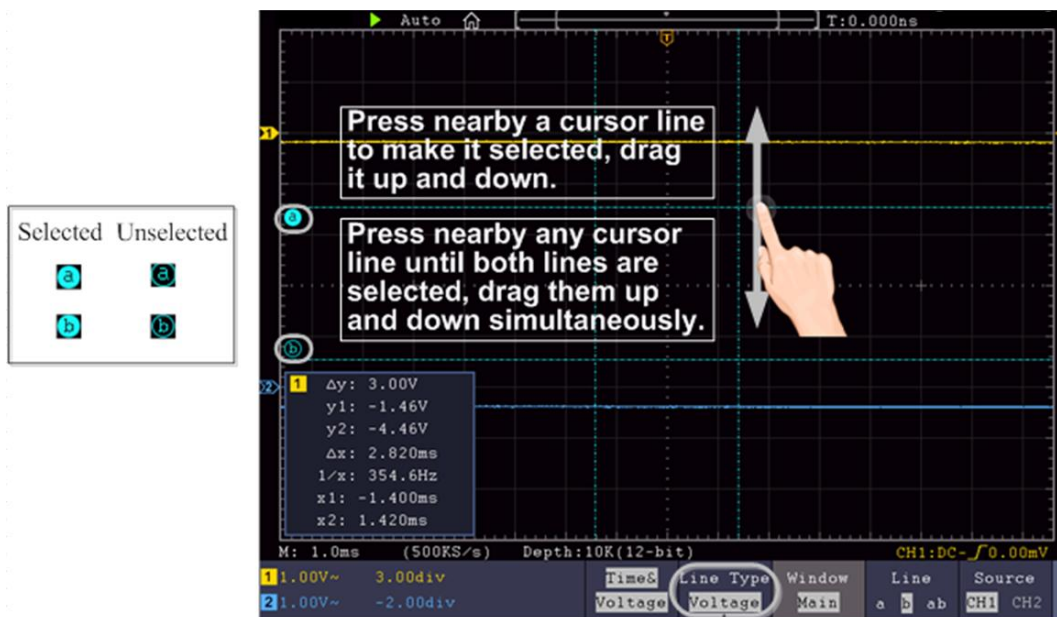
- **Measure with Cursors:**



Switch horizontal or vertical lines  
If vertical lines are selected, drag left and right.

- **Run/Stop:** Double tap on the display area, or click the  or  on the left top of the display area to run or stop the waveform sampling.
- **Touch keyboard:** Click to input.
- **Adjust value in the menu item:** .

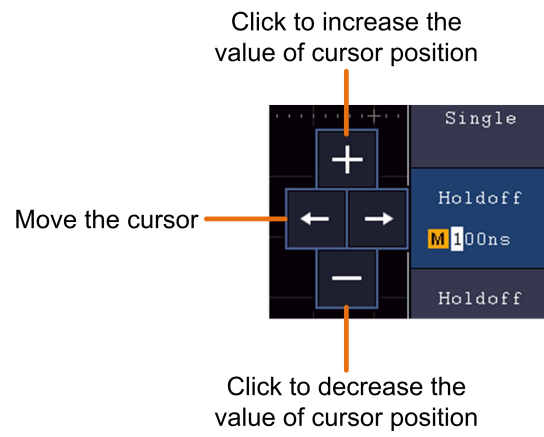

## 4. Advanced User Guidebook

Up till now, you have already been familiar with the basic operations of the function areas, buttons and knobs in the front panel of the oscilloscope. Based the introduction of the previous Chapter, the user should have an initial knowledge of the determination of the change of the oscilloscope setting through observing the status bar. If you have not been familiar with the above-mentioned operations and methods yet, we advise you to read the section of Chapter 3 "Junior User Guidebook".

This chapter will deal with the following topics mainly:

- **How to Set the Vertical System**
- **How to Set the Horizontal System**
- **How to Set the Trigger/Decoding System**
- **How to Implement the Sampling Setup**
- **How to Set the Display System**
- **How to Save and Recall Waveform**
- **How to Record/Playback Waveforms**
- **How to Clone a waveform**
- **How to Implement the Auxiliary System Function Setting**
- **How to Update your Instrument Firmware**
- **How to Measure Automatically**
- **How to Measure with Cursors**
- **How to Use Autoscale**
- **How to Use Built-in Help**
- **How to Use Executive Buttons**
- **How to Print the Screen Image**

It is recommended that you read this chapter carefully to get acquainted the various measurement functions and other operation methods of the oscilloscope.

## How to Set the Vertical System

The **VERTICAL CONTROLS** includes three menu buttons such as **CH1**, **CH2** and **Math**, and four knobs such as **Vertical Position**, **Vertical Scale** for each channel.

### Setting of CH1 and CH2

Each channel has an independent vertical menu and each item is set respectively based on the channel.

### To turn waveforms on or off (channel, math)

Pushing the **CH1**, **CH2**, or **Math** buttons have the following effect:

- If the waveform is off, the waveform is turned on and its menu is displayed.
- If the waveform is on and its menu is not displayed, its menu will be displayed.
- If the waveform is on and its menu is displayed, the waveform is turned off and its menu goes away.

The description of the Channel Menu is shown as the following list:

Function Menu	Setting	Description	
Coupling	DC AC GROUND	Pass both AC and DC components of the input signal. Block the DC component of the input signal. Disconnect the input signal.	
Inverted	ON OFF	Display inverted waveform. Display original waveform.	
Probe	Attenu	0.001X to 1000X	Step by 1 – 2 – 5. Match this to the probe attenuation factor to have an accurate reading of vertical scale.
	MeasCurr	YES NO	If you are measuring current by probing the voltage drop across a resistor, choose <b>YES</b> .
	A/V (mA/V) V/A (mV/A)		Turn the <b>M</b> knob to set the Amps/Volts ratio. The range is 100 mA/V - 1 KA/V. Amps/Volts ratio = 1/Resistor value Volts/Amp ratio is automatically calculated.
	Auto Detect	YES NO	Open or close the AutoDetect function.
Limit	Full band 20M	Get full bandwidth. Limit the channel bandwidth to 20MHz to reduce display noise.	
more	Tag	ON OFF	Select “ON” to open the tag function.
	Unit		Click to select unit V,A,W,U;When the measuring current function is enabled, the unit switching is prohibited

### 1. To set channel coupling

Taking the Channel 1 for example, the measured signal is a square wave signal containing the direct current bias. The operation steps are shown as below:

- (1) Push the **CH1** button to show the CH1 SETUP menu.
- (2) Select **Coupling** in the bottom menu.
- (3) Select **DC** in the right menu. Both DC and AC components of the signal are passed.
- (4) Select **AC** in the right menu. The direct current component of the signal is blocked.

### 2. To adjust the probe attenuation

For correct measurements, the attenuation coefficient settings in the operating menu of the Channel should always match what is on the probe (see "*How to Set the Probe Attenuation Coefficient*" on P12). If the attenuation coefficient of the probe is 1:1, the menu setting of the input channel should be set to 1X.

Take the Channel 1 as an example, the attenuation coefficient of the probe is 10:1, the operation steps are shown as follows:

- (1) Push the **CH1** button to show the CH1 SETUP menu.
- (2) Select **Probe** in the bottom menu. Select **Attenu** in the right menu, turn the **M** knob to set it as **10X**.

### 3. To measure current by probing the voltage drop across a resistor

Take the Channel 1 as an example, if you are measuring current by probing the voltage drop across a  $1\Omega$  resistor, the operation steps are shown as follows:

- (1) Push the **CH1** button to show CH1 SETUP menu.
- (2) Select **Probe** in the bottom menu. In the right menu, set **MeasCurr** as **YES**, the A/V radio menu will appear below. Select it; turn the **M** knob to set the Amps/Volts ratio. Amps/Volts ratio =  $1/\text{Resistor value}$ . Here the A/V radio should be set to 1.

### 4. To invert a waveform

Waveform inverted: the displayed signal is turned 180 degrees against the phase of the earth potential.

Taking the Channel 1 for example, the operation steps are shown as follows:

- (1) Push the **CH1** button to show the CH1 SETUP menu.
- (2) Select **Inverted** in the bottom menu, switch to **ON**. the waveform is inverted. Push again to switch to **OFF**, the waveform goes back to its original one.

### 5. To set bandwidth limit

When high frequency components of a waveform are not important to its analysis, the bandwidth limit control can be used to reject frequencies above 20 MHz.

Taking the Channel 1 for example, the operation steps are shown as below:

- (1) Push the **CH1** button to show CH1 SETUP menu.
- (2) Select **Limit** in the bottom menu.

- (3) Select **Full band** in the right menu. The high frequency of the signal will be allowed to pass.
- (4) Select **20M** in the right menu. The bandwidth is limited to 20 M. The frequencies above 20MHz will be rejected.

## Use Mathematical Manipulation Function

The **Mathematical Manipulation** function is used to show the results of the addition, multiplication, division and subtraction operations between two channels, the FFT operation for a channel, advanced math feature including Intg, Diff, Sqrt, user defined function, and digital filter. Press the **Math** button to display the menu on the bottom.

### The Waveform Calculation menu:

Function Menu	Setting	Description	
Dual Wfm Math	Factor1	CH1 CH2	Select the signal source of the factor1.
	Sign	+ - * /	Select the sign of mathematical manipulation.
	Factor2	CH1 CH2	Select the signal source of the factor2.
	Vertical (div)		Turn the <b>M</b> knob to adjust the vertical position of the Math waveform.
	Vertical (V/div)		Turn the <b>M</b> knob to adjust the vertical division of the Math waveform.
FFT	Source	CH1 CH2	Select CH1 as FFT source. Select CH2 as FFT source.
	Window	Hamming Rectangle Blackman Hanning Kaiser Bartlett	Select window for FFT.
	Format	V RMS Decibels Radian Degrees	V RMS and Decibels are amplitude unit. Radian and Degrees are phase unit.
	Hori (Hz)	Position value Time base value/	Switch to select the horizontal position or time base of the FFT waveform, turn the <b>M</b> knob to adjust it.



	Vertical	Position value Division value/	Switch to select the vertical position or vertical division of the FFT waveform, turn the <b>M</b> knob to adjust it.
User Function	Intg, Diff, Sqrt, and user defined function.		
DIR	channel	CH1 CH2	Select channel
	type	low-pass	Only the signals whose frequencies are lower than the current cut-off frequency can pass the filter.
		high-pass	Only the signals whose frequencies are greater than the current cutoff frequency can pass the filter.
		band-pass	Only the signals whose frequencies are greater than the cutoff frequency down and lower than the current cutoff frequency upper can pass the filter.
		band-reject	Only the signals whose frequencies are lower than the current cutoff frequency down or greater than the current cutoff frequency upper can pass the filter.
	window	rectangular tapered triangular Hanning Hamming Blackman	Select window for digital filter.
	cut-off fre or upper down		Turn the <b>M</b> knob to set cut-off frequency.
Vertical (div)		Turn the <b>M</b> knob to adjust the vertical position of Math waveform.	
FFT Peak	ON OFF	Enable or disable FFT peak search. Dynamic marker $\nabla$ marks the FFT peak.	

## Waveform math

Taking the additive operation between Channel 1 and Channels 2 for example, the operation steps are as follows:

1. Press the **Math** button to display the math menu in the bottom. The pink M waveform appears on the screen.
2. Select **Dual Wfm Math** in the bottom menu.
3. In the right menu, select **Factor1** as **CH1**.

4. Select **Sign** as + in the right menu.
5. In the right menu, select **Factor2** as **CH2**.
6. Select **Vertical (div)** in the right menu, turn the **M** knob to adjust the vertical position of Math waveform.
7. Select **Vertical (V/div)** in the right menu, turn the **M** knob to adjust the vertical division of Math waveform.

## User defined function

1. Press the **Math** button to display the math menu in the bottom.
2. Select **User Function** in the bottom menu, an expression input keyboard pops up.

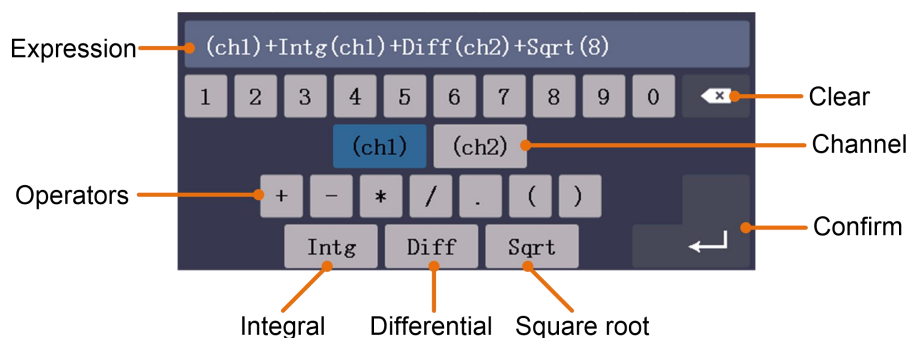

3. Create an expression. When done, choose  $\leftarrow$  in the keyboard to confirm. The division of Math waveform is displayed at the left bottom of screen.

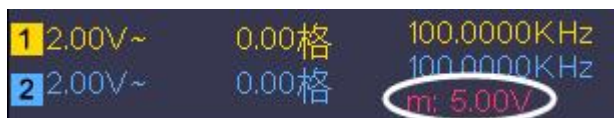

## Digital Filter

Digital filter provides 4 types of filters (low pass, high pass, band pass and band reject). The specified frequencies can be filtered by setting the cut-off frequency.

1. Press the **Math** button to display the math menu in the bottom.
2. Select **DIR** in the bottom menu.
3. In the right menu, select **channel** as **CH1** or **CH2**.
4. In the right menu, select **type**, select the desired filter type.
5. In the right menu, select **window**, select the desired window.
6. When **low-pass** or **high-pass** type is selected, select **cut-off fre** in the right menu. When **band-pass** or **band-reject** type is selected, select **upper** or **down** in the right menu. Turn **M** knob to adjust the frequency.
7. In the right menu, select **Vertical (div)**, turn **M** knob to adjust the vertical position of Math waveform. The voltage division of Math waveform is the same as the selected channel.

**Note:** On the Scan format, digital filter is disabled.

## Using FFT function

The FFT (fast Fourier transform) math function mathematically converts a time-domain waveform into its frequency components. It is very useful for analyzing the input signal on Oscilloscope. You can match these frequencies with known system frequencies, such as system clocks, oscillators, or power supplies.

FFT function in this oscilloscope transforms 8192 data points of the time-domain signal into its frequency components mathematically (the record length should be 10K or above). The final frequency contains 4096 points ranging from 0Hz to Nyquist frequency.

Taking the FFT operation for example, the operation steps are as follows:



1. Press the **Math** button to display the math menu in the bottom.
2. Select **FFT** in the bottom menu.
3. In the right menu, select **Source** as **CH1**.
4. In the right menu, select **Window**. In the left menu, turn the **M** knob to select the proper window type.
5. In the right menu, select **Format**. In the left menu, turn the **M** knob to select amplitude unit (**V RMS, Decibels**) or phase unit (**Radian, Degrees**).
6. Select **Hori (Hz)** in the right menu; select repeatedly to make the **M** symbol in front of the horizontal position value (the upper one), turn the **M** knob to adjust the horizontal position of FFT waveform; then select to make the **M** symbol in front of the time base value below, turn the **M** knob to adjust the time base of FFT waveform.
7. Select **Vertical** in the right menu; do the same operations as above to set the vertical position and vertical division.

### To select the FFT window

■ There are 6 FFT windows. Each one has trade-offs between frequency resolution and magnitude accuracy. What you want to measure and your source signal characteristics help you to determine which window to use. Use the following guidelines to select the best window.

Type	Characteristics	Window
Hamming	<p>Better solution for magnitude than Rectangle, and good for frequency as well. It has slightly better frequency resolution than Hanning.</p> <p>Recommend to use for:</p> <ul style="list-style-type: none"> <li>● Sine, periodic and narrow band random noise.</li> <li>● Transients or bursts where the signal levels before and after the event are significantly different.</li> </ul>	

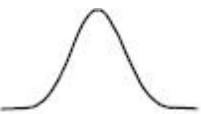
#### 4. Advanced User Guidebook

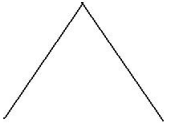
Rectangle	<p>Best solution for frequency, worst for magnitude.</p> <p>Best type for measuring the frequency spectrum of nonrepetitive signals and measuring frequency components near DC.</p> <p>Recommend to use for:</p> <ul style="list-style-type: none"> <li>● Transients or bursts, the signal level before and after the event are nearly equal.</li> <li>● Equal-amplitude sine waves with frequencies those are very close.</li> <li>● Broadband random noise with a relatively slow varying spectrum.</li> </ul>	
Blackman	<p>Best solution for magnitude, worst for frequency.</p> <p>Recommend to use for:</p> <ul style="list-style-type: none"> <li>● Single frequency waveforms, to find higher order harmonics.</li> </ul>	
Hanning	<p>Good for magnitude, but poorer frequency resolution than Hamming.</p> <p>Recommend to use for:</p> <ul style="list-style-type: none"> <li>● Sine, periodic and narrow band random noise.</li> <li>● Transients or bursts where the signal levels before and after the event are significantly different.</li> </ul>	
Kaiser	<p>The frequency resolution when using the Kaiser window is fair; the spectral leakage and amplitude accuracy are both good.</p> <p>The Kaiser window is best used when frequencies are very close to the same value but have widely differing amplitudes (the side lobe level and shape factor are closest to the traditional Gaussian RBW). This window is also good for random signals.</p>	
Bartlett	<p>The Bartlett window is a slightly narrower variant of the triangular window, with zero weight at both ends.</p>	

#### Notes for using FFT

- Use the default **dB** scale for details of multiple frequencies, even if they have very different amplitudes. Use the **dB** scale to compare frequencies.

- DC component or offset can cause incorrect magnitude values of FFT waveform. To minimize the DC component, choose AC Coupling on the source signal.
- To reduce random noise and aliased components in repetitive or single-shot events, set the oscilloscope acquisition mode to average.

### What is Nyquist frequency?

The Nyquist frequency is the highest frequency that any real-time digitizing oscilloscope can acquire without aliasing. This frequency is half of the sample rate. Frequencies above the Nyquist frequency will be under sampled, which causes aliasing. So pay more attention to the relation between the frequency being sampled and measured.

### Use Vertical Position and Scale Knobs

1. The **Vertical Position** knob is used to adjust the vertical positions of the waveforms.  
The analytic resolution of this control knob changes with the vertical division.
2. The **Vertical Scale** knob is used to regulate the vertical resolution of the waveforms. The sensitivity of the vertical division steps as 1-2-5.

The vertical position and vertical resolution is displayed at the left bottom corner of the screen (see *Figure 4-1*).

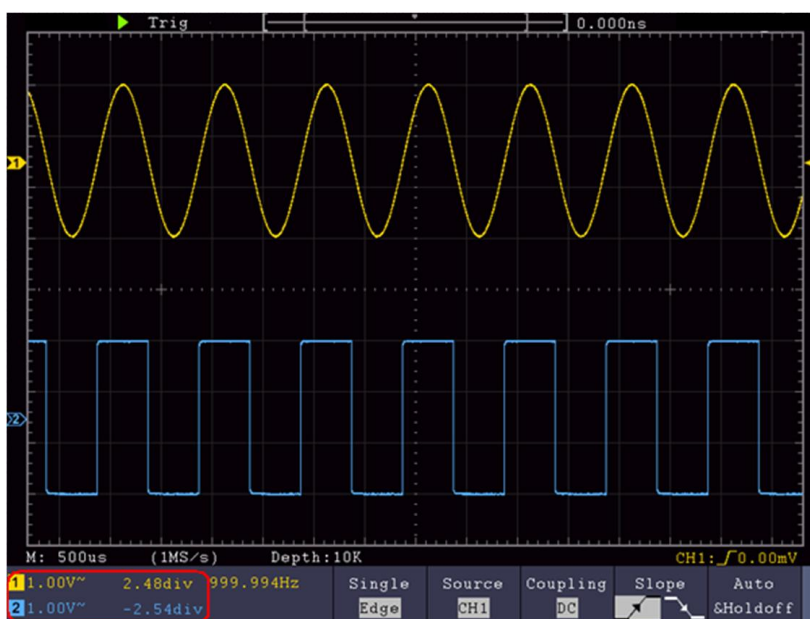

Figure 4-1 Information about Vertical Position

### How to Set the Horizontal System

The **HORIZONTAL CONTROLS** includes the **Horizontal HOR** button and such knobs as **Horizontal Position** and **Horizontal Scale**.

1. **Horizontal Position** knob: this knob is used to adjust the horizontal positions of

all channels (include those obtained from the mathematical manipulation), the analytic resolution of which changes with the time base.

2. **Horizontal Scale** knob: it is used to set the horizontal scale factor for setting the main time base or the window.
3. **Horizontal HOR** button: push it to switch between the normal mode and the wave zoom mode. For more detailed operations, see the introductions below.

## Zoom the Waveform

Push the **Horizontal HOR** button to enter wave zoom mode. The top half of the display shows the Main window and the bottom half displays the Zoom window. The Zoom window is a magnified portion of the Main window.

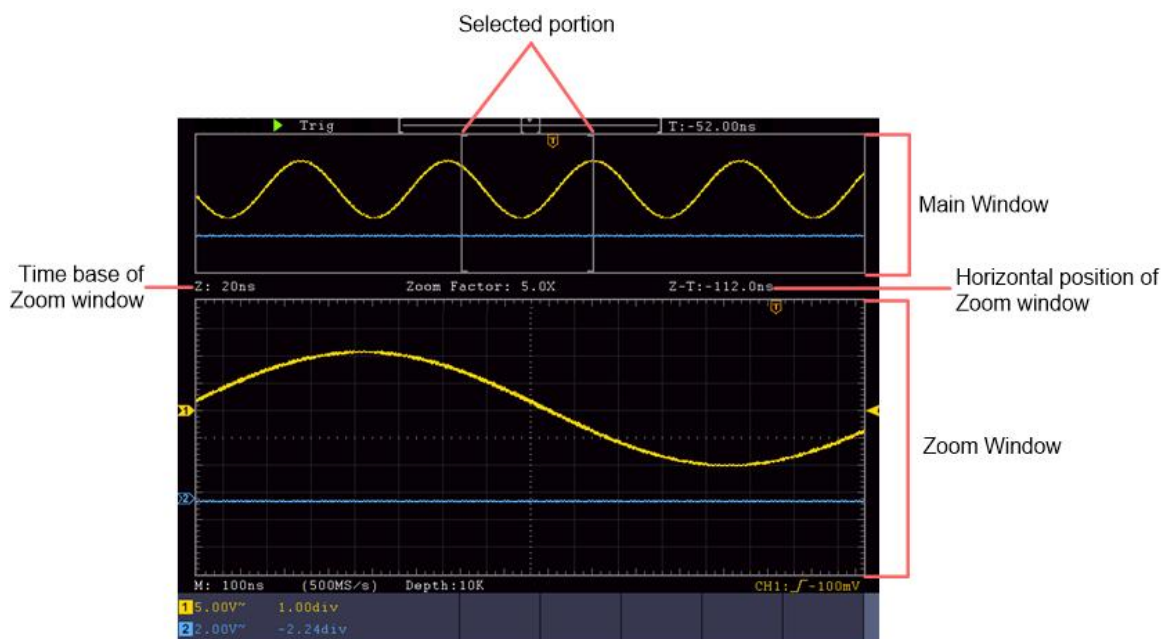

In normal mode, the **Horizontal Position** and **Horizontal Scale** knobs are used to adjust the horizontal position and time base of the Main window.

In wave zoom mode, the **Horizontal Position** and **Horizontal Scale** knobs are used to adjust the horizontal position and time base of the Zoom window.

## How to Set the Trigger/Decoding System

Trigger determines when DSO starts to acquire data and display waveform. Once trigger is set correctly, it can convert the unstable display to meaningful waveform.

When DSO starts to acquire data, it will collect enough data to draw waveform on left of trigger point. DSO continues to acquire data while waiting for trigger condition to occur. Once it detects a trigger it will acquire enough data continuously to draw the waveform on right of trigger point.

Trigger control area consists of 1 knob and 2 menu buttons.

**Trigger Level:** The knob that set the trigger level; push the knob and the level will be set as the vertical mid point values of the amplitude of the trigger

signal.

**Force:** Force to create a trigger signal and the function is mainly used in "Normal" and "Single" mode.

**Trigger Menu:** The button that activates the trigger control menu.

## Trigger Control

The oscilloscope provides four trigger types: single trigger, alternate trigger, logic trigger and bus trigger. Each type of trigger has different sub menus.

Two ways to enter trigger mode:

**Key operation:** Press Trigger **Menu** panel button, then bottom menu **Trigger Type**, select Single, ALT, Logic or Bus Trigger on the popup right menus, rotate M knob to choose different trigger types.

**Touch screen operation (optional) :** click the main menu button in the upper left corner of the screen to pop up the main menu interface, select the trigger menu, click the menu at the bottom of the screen to trigger type, select single touch, alternate, logic or bus trigger in the trigger categories on the right side of the pop-up, and click to select the trigger type under each category.

**Single trigger:** Use a trigger level to capture stable waveforms in two channels simultaneously.

**Alternate trigger:** Trigger on non-synchronized signals.

**Bus trigger:** Set bus timing trigger.

The **Single Trigger**, **Alternate Trigger**, **Logic Trigger** and **Bus Trigger** menus are described respectively as follows:

### Single Trigger

Single trigger has nine types: edge trigger, video trigger, slope trigger, pulse trigger, runt trigger, windows trigger, timeout trigger, Nth edge trigger and logic trigger.

**Edge Trigger:** It occurs when the trigger input passes through a specified voltage level with the specified slope.

**Video Trigger:** Trigger on fields or lines for standard video signal.

**Slope Trigger:** The oscilloscope begins to trigger according to the signal rising or falling speed.

**Pulse Trigger:** Find pulses with certain widths.

**Runt Trigger:** Trigger pulses that pass through one trigger level but fail to pass through the other trigger level.

**Windows Trigger:** Provide a high trigger level and low trigger level, the oscilloscope triggers when the input signal passes through the high trigger level or the low trigger level.

**Timeout Trigger:** The oscilloscope triggers when the time interval from when the rising edge (or the falling edge) passes through the trigger level to when the neighbouring falling edge (or the rising edge) passes through the trigger level is greater than the timeout time set.

**Nth Edge Trigger:** The oscilloscope triggers on the Nth edge that appears on the specified idle time.





**Logic Trigger:** Trigger the signal according to the condition of logic relationship. The nine trigger modes in Single Trigger are described respectively as follows:

### 1. Edge Trigger

An edge trigger occurs on trigger level value of the specified edge of input signal. Select Edge trigger mode to trigger on rising edge or falling edge.

In Edge Trigger mode, the trigger setting information is displayed on bottom right of the screen, for example, **CH1:DC- $\sqrt{0.00mV}$** , indicates that trigger type is edge, trigger source is CH1, coupling is DC, and trigger level is 0.00mV.

**Edge menu list:**

Menu	Settings	Instruction
Single Mode	Edge	Set vertical channel trigger type as edge trigger.
Source	CH1 CH2 EXT EXT/5 AC Line	Channel 1 as trigger signal. Channel 2 as trigger signal. External trigger as trigger signal 1/5 of the external trigger signal as trigger signal. AC power line as trigger signal.
Coupling	AC	Block the direct current component.
	DC	Allow all component pass.
	HF	Block the high-frequency signal, only low-frequency component pass.
	LF	Block the low-frequency signal, only high-frequency component pass. (LF menu is only for certain models)
	Noise Reject	ON OFF
Slope	 	Trigger on rising edge. Trigger on falling edge.
Mode&Hold	Auto Normal Single Holdoff	Acquire waveform even no trigger occurs Acquire waveform when trigger occurs When trigger occurs, acquire one waveform then stop 100 ns - 10 s, turn the <b>M</b> knob to set time interval before another trigger occur, press   panel button to move cursor to choose which digit to be set.

**Trigger Level:** trigger level indicates vertical trig position of the channel, rotate trig level knob upward and downward to move trigger level, during setting, an orange red dotted line displays to show trig position, and the value of trigger level changes at the



right corner, after setting, dotted line disappears.

## 2. Video Trigger

Choose video trigger to trigger on fields or lines of NTSC, PAL or SECAM standard video signals.

In Video Trigger mode, the trigger setting information is displayed on bottom right of the screen, for example, **CH1:  ALL**, indicates that trigger type is Video, trigger source is CH1, and Sync type is Even.

**Video Trigger menu list:**

MENU	SETTING	INSTRUCTION
Single Mode	Video	Set vertical channel trigger type as video trigger.
Source	CH1 CH2	Select CH1 as the trigger source. Select CH2 as the trigger source.
Modu	NTSC PAL SECAM	Select video modulation.
Sync	Line Field Odd Even Line NO.	Synchronic trigger in video line. Synchronic trigger in video field. Synchronic trigger in video odd filed. Synchronic trigger in video even field. Synchronic trigger in designed video line, turn the <b>M</b> knob to set the line number.
Mode&Hold	Auto	Acquire waveform even no trigger occurred.





## 3. Pulse Width Trigger

Pulse trigger occurs according to the width of pulse. The abnormal signals can be detected through setting up the pulse width condition.

In Pulse Width Trigger mode, the trigger setting information is displayed on bottom right of the screen, for example, **CH1: DC-  0.00mV**, indicates that trigger type is pulse width, trigger source is CH1, coupling is DC, polarity is positive, and trigger level is 0.00mV.

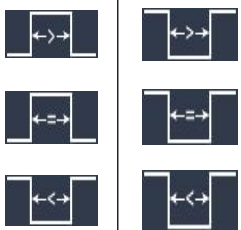
**Pulse Width Trigger menu list:**

MENU	SETTING	INSTRUCTION
Single Mode	Pulse	Set vertical channel trigger type as pulse trigger.
Source	CH1 CH2	Select CH1 as the trigger source. Select CH2 as the trigger source.
Coupling	AC DC	Not allow DC portion to pass. Allow all portion pass.
	Noise Reject	ON OFF



	<b>Polarity</b> 	Choose the polarity.
When		Select pulse width condition and adjust the <b>M</b> knob to set time, press   panel button to move cursor to choose which digit to be set.
Mode&Hold	Auto Normal Single Holdoff	Acquire waveform even no trigger occurred. Acquire waveform when trigger occurred. When trigger occurs, acquire one waveform then stop 100 ns - 10 s, adjust <b>M</b> knob to set time interval before another trigger occur, press   panel button to move cursor to choose which digit to be set.



### 4. Slope Trigger

Slope trigger sets the oscilloscope as the positive/negative slope trigger within the specified time.

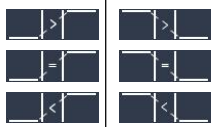
In Slope Trigger mode, the trigger setting information is displayed on bottom right of the screen, for example, **CH1:  Δ 0.00mV**, indicates that trigger type is slope, trigger source is CH1, slope is rising, 0.00mV is the differential between up level and low level threshold.



**Slope trigger menu list:**

MENU	SETTING	INSTRUCTION
Single Mode	Slope	Set vertical channel trigger type as slope trigger.
Source	CH1 CH2	Select CH1 as the trigger source. Select CH2 as the trigger source.
	Slope 	Slope selecting.
When		Set slope condition; turn the <b>M</b> knob to set slope time, press   panel button to move cursor to choose which digit to be set.
	Slew Rate	Slew rate = (High level - Low level) / Settings
Threshold &SlewRate	High level Low level Slew Rate	Adjust <b>M</b> knob to set the High level upper limit. Adjust <b>M</b> knob to set Low level lower limit. Slew rate = (High level - Low level) / Settings

Mode&Hold	Auto Normal Single Holdoff	Acquire waveform even no trigger occurred. Acquire waveform when trigger occurred. When trigger occurs, acquire one waveform then stop 100 ns – 10 s, turn the <b>M</b> knob to set time interval before another trigger occur, press   panel button to move cursor to choose which digit to be set.
-----------	-------------------------------------	---

## 5.Runt Trigger



Trigger pulses that pass through one trigger level but fail to pass through the other trigger level. Shown as below figure,

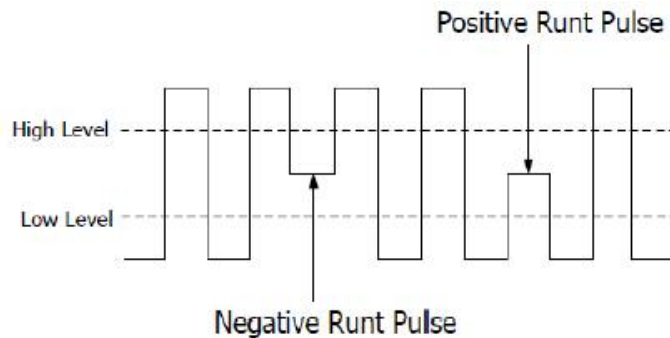



In Runt Trigger mode, the trigger setting information is displayed on bottom right of the screen, for example, **CH1:   0.00mV**, indicates that trigger type is runt, trigger source is CH1, polarity is positive, 0.00mV is the differential between up level and low level threshold.

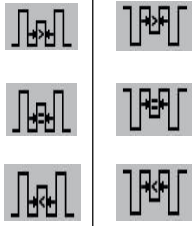

Runt Trigger

**Runt Trigger menu list:**

MENU	SETTING	INSTRUCTION
Single Mode	Runt	Set vertical channel trigger type as runt trigger.
Source	CH1 CH2	Select CH1 as the trigger source. Select CH2 as the trigger source.
Threshold	Up Level Low Level	Adjust the <b>M</b> knob to set the up level threshold. Adjust the <b>M</b> knob to set the low level threshold.
Condition	Polarity  	Positive Polarity, the oscilloscope triggers on the positive runt pulse. Negative Polarity, the oscilloscope triggers on the negative runt pulse.

		<p>Adjust the <b>M</b> knob to set pulse width, press   panel button to move cursor to choose which digit to be set.</p> <p>Trigger when runt pulse is greater than the set pulse width.</p> <p>Trigger when runt pulse equals to the set pulse width.</p> <p>Trigger when runt pulse is lower than the set pulse width.</p>
Mode&Hold	<p>Auto</p> <p>Normal</p> <p>Single</p> <p>Holdoff</p>	<p>Acquire waveform even no trigger occurred</p> <p>Acquire waveform when trigger occurred</p> <p>When trigger occurs, acquire one waveform then stop 100 ns - 10 s, adjust <b>M</b> knob to set time interval before another trigger occur, press   panel button to move cursor to choose which digit to be set.</p>



## 6.Windows Trigger

Provide a high trigger level and low trigger level, the oscilloscope triggers when the input signal passes through the high trigger level or the low trigger level.

In Windows Trigger mode, the trigger setting information is displayed on bottom right of the screen, for example, **CH1:  0.00mV**, indicates that trigger type is windows, trigger source is CH1, polarity is positive, 0.00mV the differential between up level and low level threshold.

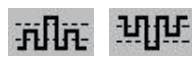
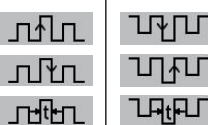
**Windows Trigger menu list:**

MENU	SETTING	INSTRUCTION
Single Mode	Windows	Set vertical channel trigger type as Windows trigger.
Source	CH1 CH2	Select CH1 as the trigger source. Select CH2 as the trigger source.
Threshold	Up Level Low Level	Adjust the <b>M</b> knob to set the up level threshold. Adjust the <b>M</b> knob to set the low level threshold.
	<p>Polarity</p> 	<p>Positive Polarity, the oscilloscope triggers on the positive Windows pulse.</p> <p>Negative Polarity, the oscilloscope triggers on the negative Windows pulse.</p>
Condition		<p><b>Enter:</b>Triggers when the trigger signal enters the specified trigger level range.</p> <p><b>Exit:</b>Triggers when the trigger signal exits the specified trigger level range.</p> <p><b>Time:</b>Specify the hold time of the input signal after entering the specified trigger level. The oscilloscope triggers when the accumulated hold time is greater than the windows time. Available range is 30ns-10s, default 100ns.</p>





Mode&Hold	Auto Normal Single Holdoff	Acquire waveform even no trigger occurred. Acquire waveform when trigger occurred. When trigger occurs, acquire one waveform then stop 100 ns - 10 s, adjust <b>M</b> knob to set time interval before another trigger occur, press   panel button to move cursor to choose which digit to be set.
-----------	-------------------------------------	--

## 7. Timeout Trigger

The oscilloscope triggers when the time interval from when the rising edge (or the falling edge) passes through the trigger level to when the neighbouring falling edge (or the rising edge) passes through the trigger level is greater than the timeout time set.

In Timeout Trigger mode, the trigger setting information is displayed on bottom right of the screen, for example, , indicates that trigger type is Timeout, trigger source is CH1, edge is positive, 0.00mV is up level or low level threshold.

**Timeout Trigger menu list:**

MENU	SETTING	INSTRUCTION
Single Mode	Timeout	Set vertical channel trigger type as Timeout trigger.
Source	CH1 CH2	Select CH1 as the trigger source. Select CH2 as the trigger source.
Edge	Edge  	Start timing when the rising edge of the input signal passes through the trigger level. Start timing when the falling edge of the input signal passes through the trigger level.
Configure	Idle Time	Set idle time. Idle time means the minimum time of idle clock before searching data that can meet trigger conditions. Available range is 30ns-10s, default 100ns.
Mode&Hold	Auto Normal Single Holdoff  Noise Reject	Acquire waveform even no trigger occurred Acquire waveform when trigger occurred When trigger occurs, acquire one waveform then stop 100 ns - 10 s, adjust <b>M</b> knob to set time interval before another trigger occur, press   panel button move cursor to choose which digit to be set. Click to open or close the Noise Reject function.

## 8. Nth Edge trigger



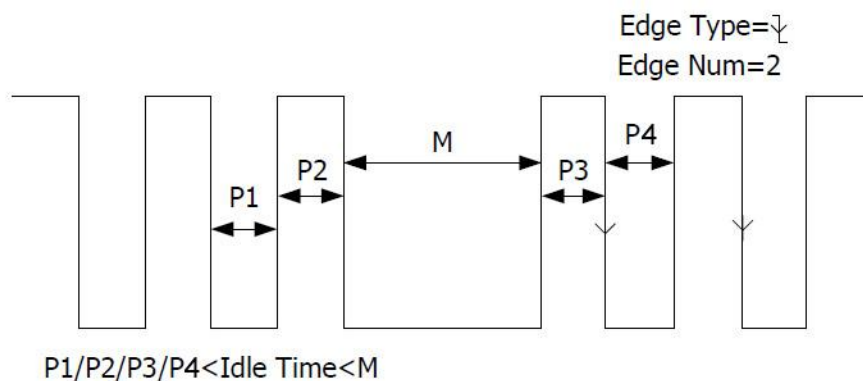

The oscilloscope triggers on the Nth edge that appears on the specified idle time. As figure shown below, the oscilloscope should trigger on the second falling edge after the specified idle time and the idle time should be set to  $P1/P2/P3/P4 < \text{Idle Time} < M$ . Wherein, M, P1, P2, P3 and P4 are positive or negative pulse width participating in the counting.

In Nth Edge Trigger mode, the trigger setting information is displayed on bottom right of the screen, for example, **CH1 : Nth 0.00mV**, indicates that trigger type is Nth Edge, trigger source is CH1, -150V is up level or low level threshold.



Nth Edge Trigger

**Nth Edge Trigger menu list:**

MENU	SETTING	INSTRUCTION
Single Mode	Nth Edge	Set vertical channel trigger type as Nth Edge trigger.
Source	CH1 CH2	Select CH1 as the trigger source. Select CH2 as the trigger source.
Edge	Edge 	Trigger on the rising edge of the input signal when voltage level meets the specified trigger level. Trigger on the falling edge of the input signal when voltage level meets the specified trigger level.
Configure	Idle Time	Set idle time before the edge counting in Nth Edge Trigger. Adjust M knob to set idle time press  panel button to move cursor to choose which digit to be set. Available range is 30ns-10s, default 100ns.
	Edge Num	Set the edge number value of "N" in Nth Edge trigger.
Mode&Hold	Auto Normal Single Holdoff	Acquire waveform even no trigger occurred Acquire waveform when trigger occurred When trigger occurs, acquire one waveform then stop 100 ns - 10 s, adjust M knob to set time interval before another trigger occur, press   panel button move cursor to choose which digit to be set.
	Noise Reject	Click to open or close the Noise Reject function.



## 9.Logic Trigger

Trigger according to logic relation.

In Logic Trigger mode, the trigger setting information is displayed on bottom right of the screen, for example, **CH1 : H 2.00V CH2 : H 0.00mV**, indicates that

trigger type is Logic, logic mode is AND, CH1 high level and trigger level is 0.00mV, CH2 high level and trigger level is 0.00mV.

**Logic Trigger menu list:**





MENU	SETTING	INSTRUCTION
Mode	Logic	Set vertical channel trigger type as Logic trigger.
Logic Mode	AND	Set logic mode as AND.
	OR	Set logic mode as OR.
	XNOR	Set logic mode as XNOR.
	XOR	Set logic mode as XOR.
Input Mode	CH1	Set CH1 as High Level, Low level, high or low level, Rise and Fall.
	CH2	Set CH2 as High Level, Low level, high or low level, Rise and Fall. <b>Note:</b> When input mode of one channel is set as Rise or Fall, the other channel could not be set as Rise and Fall at the same time.
Out Mod	Goes True	Trigger when condition turns True from False.
	Goes False	Trigger when condition turns False from True.
	Is True >	Trigger when the time of true condition is more than the set time.
	Is True <	Trigger when the time of true condition is lower than the set time.
	Is True =	Trigger when the time of true condition is equal to the set time.
Mode&Hold	Auto	Acquire waveform even no trigger occurred
	Normal	Acquire waveform when trigger occurred
	Single	When trigger occurs, acquire one waveform then stop
	Holdoff	100 ns - 10 s, adjust <b>M</b> knob to set time interval before another trigger occur, press   panel button move cursor to choose which digit to be set.
	Noise Reject	Click to open or close the Noise Reject function.

### Alternate Trigger (Trigger mode: Edge)

Trigger signal comes from two vertical channels when alternate trigger is on. This mode is used to observe two unrelated signals. Trigger mode is edge trigger.

**Alternate trigger (Trigger Type: Edge) menu list:**

Menu	Settings	Instruction
Alternate Mode	Edge	Set vertical channel trigger type as edge trigger.
Source	CH1	Channel 1 as trigger signal.
	CH2	Channel 2 as trigger signal.
Coupling	AC	Block the direct current component.
	DC	Allow all component pass.
	Noise	ON

	Reject	OFF	
Slope			Trigger on rising edge.
			Trigger on falling edge.
Mode&Hold	Auto Holdoff		Acquire waveform even no trigger occurs 100 ns - 10 s, turn the <b>M</b> knob to set time interval before another trigger occur, press   panel button to move cursor to choose which digit to be set.

## Bus Trigger

### 1. RS232/UART Trigger

RS232/UART is a serial communication mode used in the data transmission between PCs or between PC and Terminal. A character is transmitted as a frame of data which consist of 1bit start bit, 5-8bits data bits, 1bit check bit and 1-2 stop bits.

In RS232/UART bus trigger mode, the trigger setting information is displayed on



bottom right of the screen, for example, **RS232 CH1:0.00mV**, indicates that trigger type is RS232/UART, CH1 trigger level is 0.00mV.

Format as shown in the figure below,



RS232/UART Trigger

**RS232/UART Trigger menu list:**

MENU	SETTING	INSTRUCTION
Bus Type	RS232/UART	Set vertical channel bus type as RS232/UART trigger.
Input	Source	CH1 Select CH1 as the trigger source.
		CH2 Select CH2 as the trigger source.
Polarity		Select polarity.
		
When	Start	Trigger on the start frame of position. After choosing this condition, press Configure to enter detailed settings.
	Error	Trigger when error frame is detected. After choosing this condition, press Configure to enter detailed settings.



	Chk Error	Trigger when Chk Error is detected. After choosing this condition, press Configure to enter detailed settings.
	Data	Trigger on the last bit of the preset data. After choosing this condition, press Configure to enter detailed settings.
Configure	Start	<b>Common Baud:</b> adjust <b>M</b> knob to choose <b>common baud</b> . <b>Custom Baud:</b> adjust <b>M</b> knob to choose <b>baud</b> , ranges from 50 to 10,000,000.
	Error	<b>Stop Bit:</b> Select “1”or”2”. <b>Parity:</b> “None”“Even”“Odd” <b>Common Baud:</b> adjust <b>M</b> knob to choose <b>common baud</b> . <b>Custom Baud:</b> adjust <b>M</b> knob to choose <b>baud</b> , ranges from 50 to 10,000,000.
	Chk Error	<b>Even-Odd:</b> Select Even or Odd. <b>Common Baud:</b> adjust <b>M</b> knob to choose <b>common baud</b> . <b>Custom Baud:</b> adjust <b>M</b> knob to choose <b>baud</b> , ranges from 50 to 10,000,000.
	Data	<b>Data Bits:</b> Set as 5、 6、 7、 8 bits. <b>Data:</b> Set data according to data bits, ranges from 0-31, 0-63, 0-127 or 0-255. <b>Common Baud:</b> adjust <b>M</b> knob to choose <b>common baud</b> . <b>Custom Baud:</b> adjust <b>M</b> knob to choose <b>baud</b> , ranges from 50 to 10,000,000.
Mode	Auto Normal Single	Acquire waveform even no trigger occurred Acquire waveform when trigger occurred When trigger occurs, acquire one waveform then stop

## 2. I2C Trigger

The I2C serial bus consists of SCL and SDA. The transmission rate is determined by SCL, and the transmission data is determined by SDA. As shown in below figure, oscilloscope can trigger on the start, restart, stop, ack lost, specific device address or data value, also device address and data value at the same time.

In I2C bus trigger mode, the trigger setting information is displayed on bottom right of the screen, for example, **I2C CH1:0.00mV CH2:0.00mV**, indicates that trigger type is I2C, CH1 trigger level is 0.00mV, CH2 trigger level is 0.00mV.

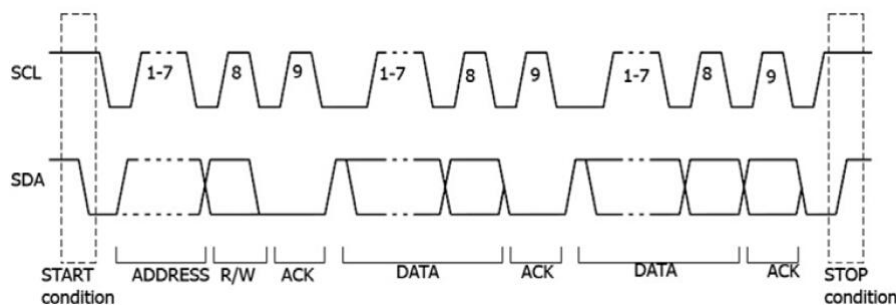

**I2C Trigger menu list:**

MENU	SETTING	INSTRUCTION	
Bus Type	I2C	Set vertical channel bus type as I2C trigger.	
Source	CH1 CH2	Set CH1 as SCL or SDA. Set CH2 as SCL or SDA.	
When	Start	Trigger when SDA data transitions from high to low while SCL is high.	
	Restart	When another start condition occurs before a stop condition.	
	Stop	Trigger when SDA data transitions from low to high while SCL is high.	
	Ack Lost	Trigger when SDA data is high during any acknowledgement of SCL clock position.	
	Address	Trigger on the read or write bit when the preset address is met.	
	Adr Format	Addr Bits	Set Address Bits to be “7”、 “8” or “10”.
		Address	Set address according to the preset address bits, address range is 0-127, 0-255, 0-1023 respectively.
		Direction	Set Data Direction to be Read or Write. Note: The set is not available when Address bits is set to “8”.
	Data	Search for the preset data value on SDA and trigger on the dump edge of SCL of the last bit of the data area.	
	DatFormat	Byte length	Set data byte length, available range 1-5 bytes. Adjust <b>M</b> knob to set byte length.
Current Bit		Select the data bit, ranges from 0 to (byte length*8 -1).	
Data		Set data to be H, L or X (H or L).	
All Bits		Set all the data bits to be the specified value in Data.	
Addr / Data	Trigger when Address and Data conditions are met at the same time .		

Mode	Auto	Acquire waveform even no trigger occurred.
	Normal	Acquire waveform when trigger occurred.
	Single	When trigger occurs, acquire one waveform then stop.





### 3. SPI Trigger

Trigger on the specified data when the timeout condition is meet. When using SPI trigger, you need to specify the SCL and SDA data sources.

In SPI bus trigger mode, the trigger setting information is displayed on bottom right of the screen, for example, **SPI CH1:0.00mV CH2:0.00mV**, indicates that

trigger type is SPI, CH1 trigger level is 0.00mV, CH2 trigger level is 0.00mV.

**SPI Trigger menu list:**

MENU	SETTING	INSTRUCTION
Bus Type	SPI	Set vertical channel bus type as SPI trigger.
Source	CH1 CH2	Set CH1 as SCL or SDA. Set CH2 as SCL or SDA.
Time Out	Time out	Set the minimum time that SCL must be idle, that is a period of SCL, available range 100ns-10s. Time out means SCL keeps idle for a specified time before oscilloscope starts to search for the data(SDA) on which to trigger. adjust <b>M</b> knob to set time out, press   panel button move cursor to choose which digit to be set.
ClockEdge &Data	Clock Edge  	Set Edge Clock as Rising edge or Falling edge. Means sample the SDA data on the rising edge or falling edge of the clock.
	Data Bits	Set the number of bits of the serial data character string. It can be set to any integer between 4-32. adjust <b>M</b> knob to set Data Bits.
	CurrentBit	Set the number of the data bits, ranges from 0-31, adjust <b>M</b> knob to set Current Bit.
	Data	Set the value of the current data bit as H,L or X (H or L).
	All Bits	Set all the data bits to be the specified value in Data.
Mode	Auto Normal Single	Acquire waveform even no trigger occurred Acquire waveform when trigger occurred When trigger occurs, acquire one waveform then stop

### 4. CAN Trigger

CAN (Controller Area Network) is a serial communication protocol of the ISO international standardization.

By using the CAN bus trigger, you can trigger on **Start of Frame, Type of Frame, Identifier, Data, ID & Data, End of Frame, Missing Ack, or Bit Stuffing Error**. You need to specify the signal source, trigger signal type, sample point, and signal rate of the CAN signal.

In CAN bus trigger mode, the trigger setting information is displayed on bottom right of the screen, for example, **CAN CH1:-126mV**, indicates that trigger type is CAN, CH1 trigger level is -126 mV.

**CAN Trigger menu list:**

MENU	SETTING	INSTRUCTION		
Bus Type	CAN	Set vertical channel bus type as CAN trigger.		
Input	Source	CH1	Select CH1 as the trigger source.	
		CH2	Select CH2 as the trigger source.	
	Type	CAN_H	Actual CAN_H bus signal.	
		CAN_L	Actual CAN_L bus signal.	
		TX	Transmission signal on the CAN signal line.	
		RX	Received signal on the CAN signal line.	
Sample Point	Turn the <b>M</b> knob to set the Sample point, which is a point within a bit's time. The oscilloscope samples the bit level at this point. "Sample point" is represented by the percentage of "the time from the start of the bit's time to the sample point time" in the "bit's time". The range is 5% to 95%.			
Common Baud	Turn the <b>M</b> knob to select from the Baud list on the left.			
Custom Baud	Turn the <b>M</b> knob to set the Baud. The range is 10,000 to 1,000,000. <b>Tip:</b> You can select the nearest value in Common Baud, and then adjust it in this menu.			
Condition	Start	Trigger on the start frame of the data frame.		
	Type	Type (Bottom menu)	Data	Trigger on the selected frame.
			Remote	
			Error	
			Overload	
	ID	Configure (Bottom menu)	Format	Select Standard or Extend.
			ID	Use the <b>M</b> knob and <b>Direction key</b> on the front panel to set.
Data	Configure (Bottom menu)	Byte Length	Set the number of bytes with the <b>M</b> knob. The range is 1 to 8.	
		Data	Set the data with the <b>M</b> knob and <b>Direction key</b> on the front panel.	
ID&Data	Configure	Format	Select Standard or Extended.	

		(Bottom menu)	ID	Use the <b>M</b> knob and <b>Direction key</b> on the front panel to set.
			Byte Length	Set the number of bytes with the <b>M</b> knob. The range is 1 to 8.
			Data	Set the data with the <b>M</b> knob and <b>Direction key</b> on the front panel.
	End	Trigger on the end frame of the data frame.		
	Lost	Trigger on Missing Ack.		
	Error	Trigger on Bit Stuffing Error.		
Mode	Auto	Acquire waveform even no trigger occurred.		
	Normal	Acquire waveform when trigger occurred.		
	Single	When trigger occurs, acquire one waveform then stop.		

## Bus Decoding

### 1. RS232/UART Decoding

To decode RS232/UART signal:

- (1) Connect the RS232/UART signal to the Signal Input Channel of the oscilloscope.
- (2) Adjust to the proper time base and voltage division.
- (3) In trigger menu, select Bus trigger, and select bus type as RS232/UART, set parameters based on the characteristics of the signal, trigger the signal correctly and obtain stable display. Refer to "*RS232/UART Trigger*" on page 43.
- (4) Push the **Decode** button on the front panel. Select bus type as RS232/UART. set parameters based on the characteristics of the signal. When the parameters are set correctly, the information carried by the signal will be displayed.

**Tip:** If there are repetitive menu items in both trigger menu and decoding menu, you can set anyone of them, the other will be changed synchronously.

**Note:**

- Use the **Trigger Level** knob to adjust the thresholds of bus trigger and bus decoding.
- When decoding, if "Parity" is not set to "None", and the check bit error is detected, two red error marks will be displayed in the corresponding position in the waveform.

**RS232/UART Decoding menu list:**

MENU	SETTING	INSTRUCTION
Bus Type	RS232/UART	Set bus type of decoding as RS232/UART.
Configure	Common Baud	Turn the <b>M</b> knob to select from the Baud list on the left.

	Custom Baud	Turn the <b>M</b> knob to set the Baud. The range is 50 to 10,000,000. <b>Tip:</b> You can select the nearest value in Common Baud, and then adjust it in this menu.	
	Data Bits	Set the data width of each frame to match the signal. It can be set to 5, 6, 7 or 8.	
	Parity	set the even-odd check mode to match the polarity used by the signal.	
Display	Format	Binary Decimal Hex ASCII	Set the display format of the bus.
	EventTable	ON OFF	Select "ON" to display the event table.
	Save EventTable	If a USB storage device is currently connected to the instrument, save the event table data in a .csv (spreadsheet) formatted file on the external USB storage device.	
	ASCII Table	ON OFF	Select "ON" to display the ASCII table.

## 2. I2C Decoding

To decode I2C signal:

- (1) Connect the clock line (SCLK) and the data line (SDA) of the I2C signal to the Signal Input Channels of the oscilloscope.
- (2) Adjust to the proper time base and voltage division.
- (3) In trigger menu, select Bus trigger, and select bus type as I2C, set parameters based on the characteristics of the signal, trigger the signal correctly and obtain stable display. Refer to "*I2C Trigger*" on page 44.
- (4) Push the **Decode** button on the front panel. Select bus type as I2C. set parameters based on the characteristics of the signal. When the parameters are set correctly, the information carried by the signal will be displayed.

**Tip:** If there are repetitive menu items in both trigger menu and decoding menu, you can set anyone of them, the other will be changed synchronously.

### Decoded information interpretation:

Information	Abbreviation	Background
Read Address	R, Read, or do not display	Green
Write Address	W, Write, or do not display	Green
Data	D, Data, or do not display	Black

**Note:**

- Use the **Trigger Level** knob to adjust the thresholds of bus trigger and bus decoding.
- When the ACK (ACKnowledge Character) is not met, two red error marks will be displayed in the corresponding position in the waveform.

**I2C Decoding menu list:**

MENU	SETTING	INSTRUCTION	
Bus Type	I2C	Set bus type of decoding as I2C.	
Display	Format	Binary Decimal Hex ASCII	Set the display format of the bus.
	EventTable	ON OFF	Select "ON" to display the event table.
	Save EventTable	If a USB storage device is currently connected to the instrument, save the event table data in a .csv (spreadsheet) formatted file on the external USB storage device.	
	ASCII Table	ON OFF	Select "ON" to display the ASCII table.

**3. SPI Decoding**

To decode SPI signal:

- (1) Connect the clock line (SCLK) and the data line (SDA) of the SPI signal to the Signal Input Channels of the oscilloscope.
- (2) Adjust to the proper time base and voltage division.
- (3) In trigger menu, select Bus trigger, and select bus type as SPI, set parameters based on the characteristics of the signal, trigger the signal correctly and obtain stable display. Refer to "*SPI Trigger*" on page 46.
- (4) Push the **Decode** button on the front panel. Select bus type as SPI. set parameters based on the characteristics of the signal. When the parameters are set correctly, the information carried by the signal will be displayed.

**Tip:** If there are repetitive menu items in both trigger menu and decoding menu, you can set anyone of them, the other will be changed synchronously.

**Note:**

- Use the **Trigger Level** knob to adjust the thresholds of bus trigger and bus decoding.
- **LS First** in Bit Order menu item (Least Significant Bit First) means that the least significant bit will arrive first: hence e.g. the hexadecimal number 0x12, will

arrive as the sequence 01001000 in binary representation, will be decoded as the reversed sequence 00010010.

#### SPI Decoding menu list:

MENU	SETTING	INSTRUCTION	
Bus Type	SPI	Set bus type of decoding as SPI.	
Configure	SCLK	Select the clock edge to match the signal, sample the SDA data on the rising or falling edge of the clock.	
	Time Out	Set the minimum time that the clock (SCL) signal must be idle before the oscilloscope starts to search for the data (SDA) on which to trigger. The range is 30 ns to 10 s.	
	Data Bits	Set the data width of each frame to match the signal. It can be set to any integer between 4 and 32.	
	Bit Order	Select LS First or MS First to match the signal.	
Display	Format	Binary Decimal Hex ASCII	Set the display format of the bus.
	EventTable	ON OFF	Select "ON" to display the event table.
	Save EventTable	If a USB storage device is currently connected to the instrument, save the event table data in a .csv (spreadsheet) formatted file on the external USB storage device.	
	ASCII Table	ON OFF	Select "ON" to display the ASCII table.

## 4. CAN Decoding

To decode CAN signal:

- (1) Connect the CAN signal to the Signal Input Channel of the oscilloscope.
- (2) Adjust to the proper time base and voltage division.
- (3) In trigger menu, select Bus trigger, and select bus type as CAN, set parameters based on the characteristics of the signal, trigger the signal correctly and obtain stable display. Refer to "*CAN Trigger*" on page 46.
- (4) Push the **Decode** button on the front panel. Select bus type as CAN. set parameters based on the characteristics of the signal. When the parameters are set correctly, the information carried by the signal will be displayed.

**Tip:** If there are repetitive menu items in both trigger menu and decoding menu, you can set anyone of them, the other will be changed synchronously.



**Decoded information interpretation:**

Information	Abbreviation	Background
Identifier	I, ID, or do not display	Green
Overload Frame	OF	Green
Error Frame	EF	Green
Data Length code	L, DLC, or do not display	Blue
Data	D, Data, or do not display	Black
Cyclic Redundancy Check	C, CRC, or do not display	Valid: Purple Error: Red

**Note:**

- Use the **Trigger Level** knob to adjust the thresholds of bus trigger and bus decoding.
- When the ACK (ACKnowledge Character) of Data Frame or Remote Frame is not met, two red error marks will be displayed in the corresponding position in the waveform.
- Error Frame, Remote Frame, and Overload Frame will be identified in the "Data" column in the event table (Data Frame will not be identified).

**CAN Decoding menu list:**

MENU	SETTING	INSTRUCTION	
Bus Type	CAN	Set bus type of decoding as CAN.	
Display	Format	Binary Decimal Hex ASCII	Set the display format of the bus.
	EventTable	ON OFF	Select "ON" to display the event table.
	Save EventTable	If a USB storage device is currently connected to the instrument, save the event table data in a .csv (spreadsheet) formatted file on the external USB storage device.	
	ASCII Table	ON OFF	Select "ON" to display the ASCII table.

**How to Operate the Function Menu**

The function menu control zone includes 8 function menu buttons: **Measure, Acquire, Utility, Cursor, Autoscale, Save, Display, Help** and 3 immediate-execution buttons: **Autoset, Run/Stop, Single**.

## How to Implement Sampling Setup

Push the **Acquire** button, **Acqu Mode**, **Length**, **PERF Mode** and **Intrpl** is shown in the bottom menu.

The description of the **Acqu Mode** menu is shown as follows:

Function Menu	Setting	Description
Acqu Mode	Sample	Normal sampling mode.
	Peak Detect	Use to capture maximal and minimal samples. Finding highest and lowest points over adjacent intervals. It is used for the detection of the jamming burr and the possibility of reducing the confusion.
	Average	4, 16, 64, 128 It is used to reduce the random and don't-care noises, with the optional number of averages.

The description of the **Record Length** menu is shown as follows:

Function Menu	Setting	Description
Length	1000	Choose the record length.
	10K	
	100K	
	1M	
	10M	
	20M (Single CH)	
	40M	
	80M	

The description of **PERF Mode** menu is shown as follows:

Function Menu	Setting	Description
PERF Mode	8-bit	Set the vertical resolution (A/D)
	12-bit	

When the sample rate  $\leq 250\text{MS/s}$ , ADC resolution is set to 12-bit by default;

When the sample rate  $> 250\text{MS/s}$ , and both channels are turned on, ADC resolution is set to 8-bit by default;

When the sample rate  $< 250\text{MS/s}$ , and only one channel is turned on, ADC resolution can be set to 8-bit or 12-bit in this menu.

The description of the **Intrpl** menu is shown as follows:

Function Menu	Setting	Description
Intrpl	Sinx/x	Use sine(x)/x interpolation
	x	Use linear interpolation

Interpolation method is a processing method to connect the sampled points, using

some points to calculate the whole appearance of the waveform. Select the appropriate interpolation method according to the actual signal.

**Sine(x)/x interpolation:** Connect the sampled points with curved lines.

**Linear interpolation:** Connect the sampled points with straight lines. This method is suitable to rebuild the straight-edged signals, such as square or pulse wave.

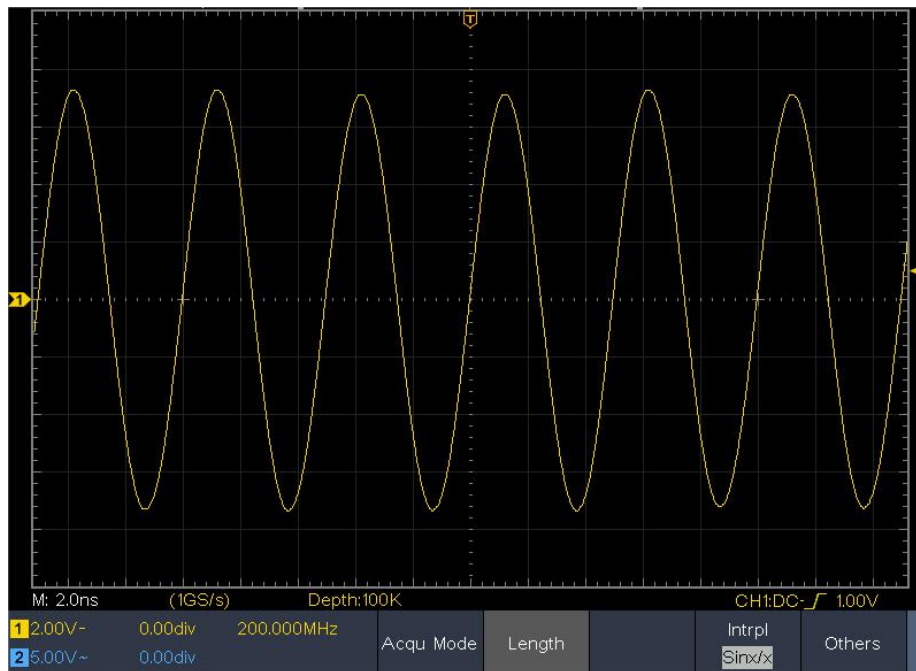

**Sine(x)/x interpolation**

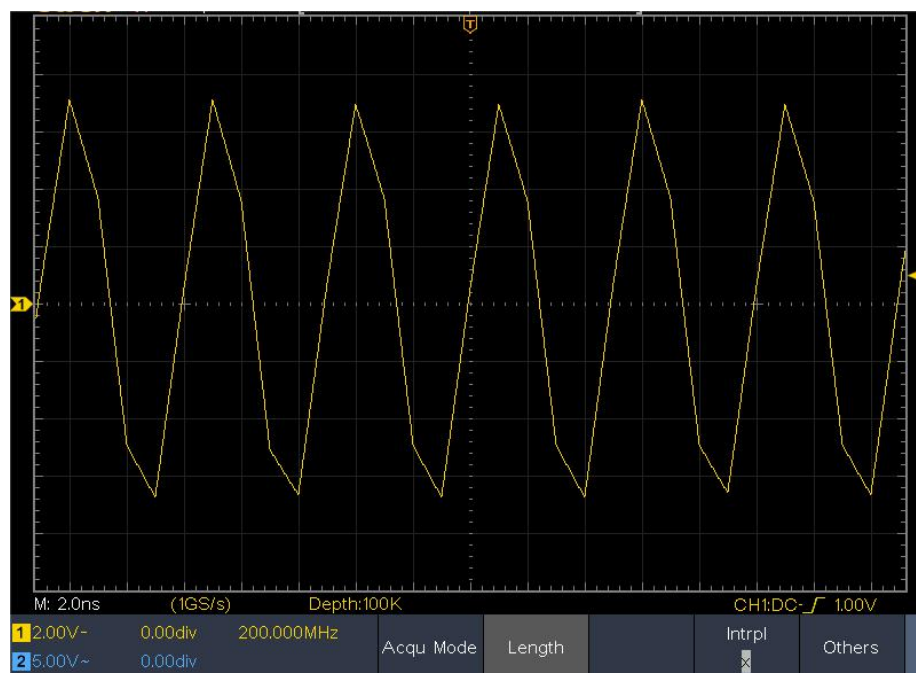

**Linear interpolation**

## How to Set the Display System

Push the **Display** button and the Display menu is shown as follows:

Function Menu	Setting	Description
Type	Dots Vect	Only the sampling points are displayed. The space between the adjacent sampling points in the display is filled with the vector form.
Persist	OFF 1 Second 2 Seconds 5 Seconds Infinity	Set the persistence time.
XY Mode	Enable      ON OFF	Turn on/off XY display function.
	Full      ON Screen    OFF	Turn on/off the full screen view in XY mode.
Counter	ON OFF	Turn on/off counter.
Clear		Erase the results of previous acquisitions from the display. The oscilloscope will start to accumulate acquisitions again.

### Persist

When the **Persist** function is used, the persistence display effect of the picture tube oscilloscope can be simulated. The reserved original data is displayed in fade color and the new data is in bright color.

- (1) Push the **Display** button.
- (2) Select **Persist** in the bottom menu.
- (3) In the Time menu, select the persist time, including **OFF**, **1 Second**, **2 Seconds**, **5 Seconds** and **Infinity**. When the "**Infinity**" option is set for Persist Time, the measuring points will be stored till the controlling value is changed. Select **OFF** to turn off persistence and clear the display.
- (4) Select **Clear** in the bottom menu to erase the results of previous acquisitions from the display. The oscilloscope will start to accumulate acquisitions again.

### XY Format

This format is only applicable to Channel 1 and Channel 2. After the XY display format is selected, Channel 1 is displayed in the horizontal axis and Channel 2 in the vertical axis; the oscilloscope is set in the un-triggered sample mode: the data are displayed as bright spots.

**The operations of all control knobs are as follows:**

- The **Vertical Scale** and the **Vertical Position** knobs of Channel 1 are used to set the horizontal scale and position.
- The **Vertical Scale** and the **Vertical Position** knobs of Channel 2 are used to set the vertical scale and position continuously.

**The following functions can not work in the XY Format:**

- Reference or digital wave form
- Cursor
- Trigger control
- FFT

Operation steps:

1. Push the **Display** button.
2. Select **XY Mode** in the bottom menu. Select **Enable** as **ON** in the right menu.
3. To make the XY view full screen, select **Full Screen** as **ON** in the right menu.

### Counter

It is a 6-digit single-channel counter. The counter can only measure the frequency of the triggering channel. The frequency range is from 2Hz to the full bandwidth. Only if the measured channel is in **Edge** mode of **Single** trigger type, the counter can be enabled. The counter is displayed at the bottom of the screen.

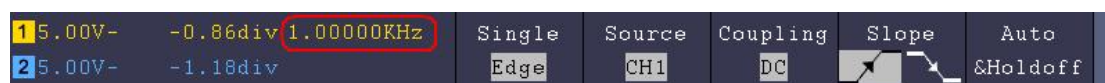

Operation steps:

1. Push **Trigger Menu** button, set the trigger type to **Single**, set the trigger mode to **Edge**, select the signal source.
2. Push the **Display** button.
3. Select **Counter** as **ON** or **OFF** in the bottom menu.

### How to Save and Recall a Waveform

Push the **Save** button, you can save the waveforms, configures, screen images, record or clone the waveform.

The description of the **Save Function Menu** is shown as the following table:

Function Menu	Setting	Description
Type	Wave	Choose the saving type.
	Configure	About the <b>Record</b> type, see " <i>How to Record/Playback Waveforms</i> " on P63.
	Record	About the <b>Clone</b> type, see " <i>How to Clone a waveform</i> " on P66.
	Clone	

When the type is <b>Wave</b> , the menu shows as following:			
Type Wave	Format (Right menu)		For internal storage, only BIN can be selected. For external storage, the format can be BIN, TXT or CSV.
Source	CH1 CH2 Math All		Choose the waveform to be saved. (If certain channel is off, the corresponding menu item will be disabled.) Choose <b>All</b> to save all the waveforms that are turned on. You can save into the current internal object address, or into USB storage as a single file.
Object & Show	Object	0 - 49	Choose the address which the waveform is saved to or recall from.
	Show	ON OFF	Recall or close the waveform stored in the current object address. When the show is ON, if the current object address has been used, the stored waveform will be shown, the address number and relevant information will be displayed at the top left of the screen; if the address is empty, it will prompt "None is saved".
	Close All		Close all the waveforms stored in the object address.
Save			Save the waveform of the source to the selected address. Whatever the <b>Type</b> of save menu is set, you can save the waveform by just pressing the <b>Copy</b> panel button in any user interface. Select <b>Type</b> in the bottom menu, in the right <b>Format</b> menu, you can select the storage format.
Storage	Internal External		Save to internal storage or USB storage. When External is selected, save the waveform according to the current record length (see "Record Length menu" on P53); the file name is editable. The BIN waveform file could be open by waveform analysis software (on the supplied CD).
When the type is <b>Configure</b> , the menu shows as following:			
Configure	Setting0 ..... Setting19		The setting address.
Save			Save the current oscilloscope configure to the internal storage

Load		Recall the configure from the selected address
When the type is <b>Image</b> , the menu shows as following:		
Ink Saver	ON OFF	Select "ON" to open the ink saver.
Save		Save the current display screen. The file can be only stored in a USB storage, so a USB storage must be connected first. The file name is editable. The file is stored in BMP format.

### Save and Recall the Waveform

The oscilloscope can store 50 waveforms, which can be displayed with the current waveform at the same time. The stored waveform called out can not be adjusted.

In order to save the waveform of CH1, CH2 and Math into the address 1, the operation steps should be followed:

1. Turn on CH1, CH2 and Math channels.
2. Push the **Save** button.
3. **Saving:** Select **Type** in the bottom menu, select **Wave** in the left menu.
4. Select **Storage** in the bottom menu, select **Internal** in the right menu.
5. Select **Source** in the bottom menu, select **All** in the right menu for Source.
6. Select **Object & Show** in the bottom menu, select **1** as object address in the left menu.
7. Select **Save** in the bottom menu to save the waveform.
8. **Recalling:** Select **Object & Show** in the bottom menu, select **1** in the left menu. In the right menu, select **Show** as **ON**, the waveform stored in the address will be shown, the address number and relevant information will be displayed at the top left of the screen.

In order to save the waveform of CH1 and CH2 into the USB storage as a BIN file, the operation steps should be followed:

1. Turn on CH1 and CH2 channels, turn off the Math channel.
2. Push the **Save** button.
3. **Saving:** Select **Type** in the bottom menu, select **Wave** in the left menu.
4. Select **Storage** in the bottom menu, select **External** in the right menu.
5. Select **Type** in the bottom menu, select **BIN** in the right menu as the storage format.
6. Select **Source** in the bottom menu, select **All** in the right menu for Source.
7. Select **Save** in the bottom menu, an input keyboard used to edit the file name will pop up. The default name is current system date and time. Select the  key in

the keyboard to confirm.



8. **Recalling:** The BIN waveform file could be open by waveform analysis software (on the supplied CD).

**Tip:**

Whatever the **Type** of save menu is set, you can save the waveform by just pressing the **Copy** panel button in any user interface. If the **Storage** of the save menu is set as "**External**", you should install the USB disk. Please refer to the contents below to install the USB disk and name the file to be saved.

**Save the current screen image:**

The screen image can only be stored in USB disk, so you should connect a USB disk with the instrument.

1. **Install the USB disk:** Insert the USB disk into the "**USB Host port**" of "*Figure 3-1 Front panel*". If an icon  appears on the top right of the screen, the USB disk is installed successfully. If the USB disk cannot be recognized, format the USB disk according to the methods in "*USB disk Requirements*" on P59.
2. After the USB disk is installed, push the **Save** panel button, the save menu is displayed at the bottom of the screen.
3. Select **Type** in the bottom menu, select **Image** in the left menu.
4. Select **Save** in the bottom menu, an input keyboard used to edit the file name will pop up. The default name is current system date and time. Select the  key in the keyboard to confirm.

**USB disk Requirements**

The supported format of the USB disk: FAT32 file system, the allocation unit size cannot exceed 4K, mass storage USB disk is also supported. If the USB disk doesn't work properly, format it into the supported format and try again. Follow any of the following two methods to format the USB disk: using system-provided function and using the formatting tools. (The USB disk of 8 G or 8 G above can only be formatted using the second method – using the formatting tools.)

**Use system-provided function to format the USB disk**

1. Connect the USB disk to the computer.
2. Right click **Computer**-> **Manage** to enter Computer Management interface.
3. Click Disk Management menu, and information about the USB disk will display on the right side with red mark 1 and 2.



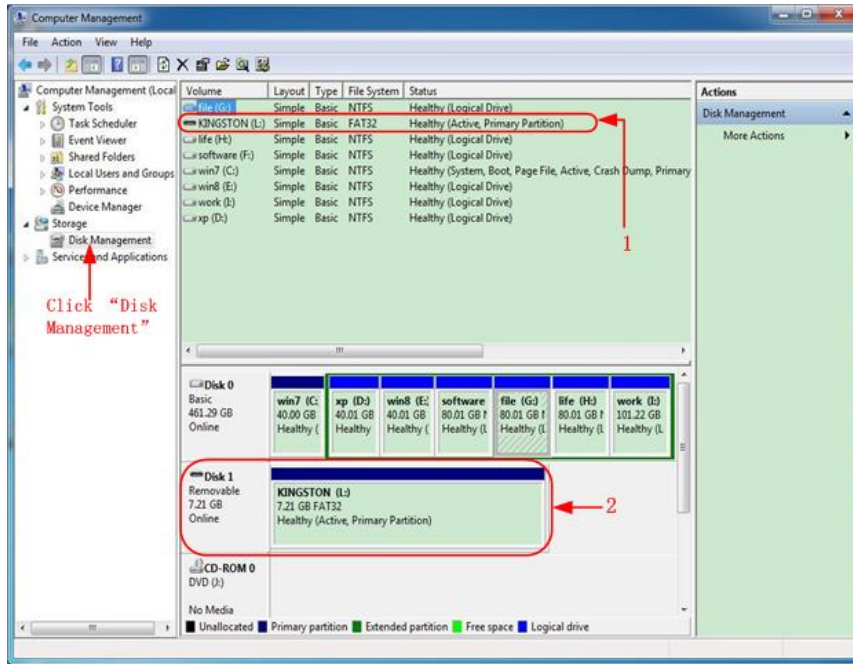

Figure 4-2: Disk Management of computer

- Right click 1 or 2 red mark area, choose **Format**. And system will pop up a warning message, click **Yes**.

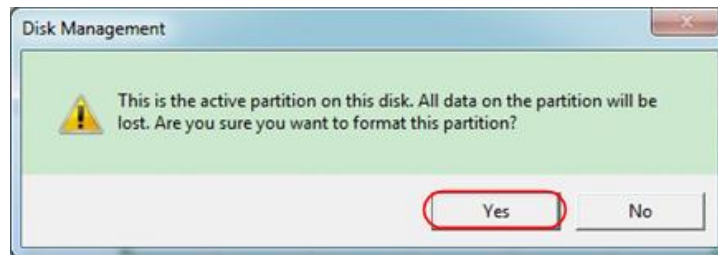

Figure 4-3: Format the USB disk warning

- Set File System as FAT32, Allocation unit size 4096. Check "**Perform a quick format**" to execute a quick format. Click **OK**, and then click **Yes** on the warning message.

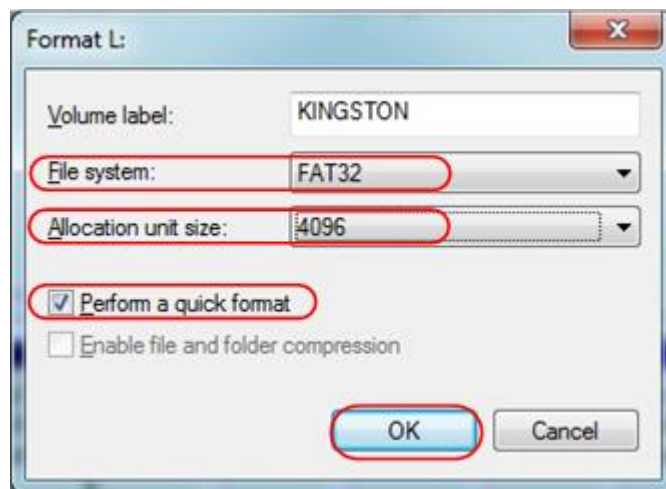

Figure 4-4: Formatting the USB disk setting

## 6. Formatting process.

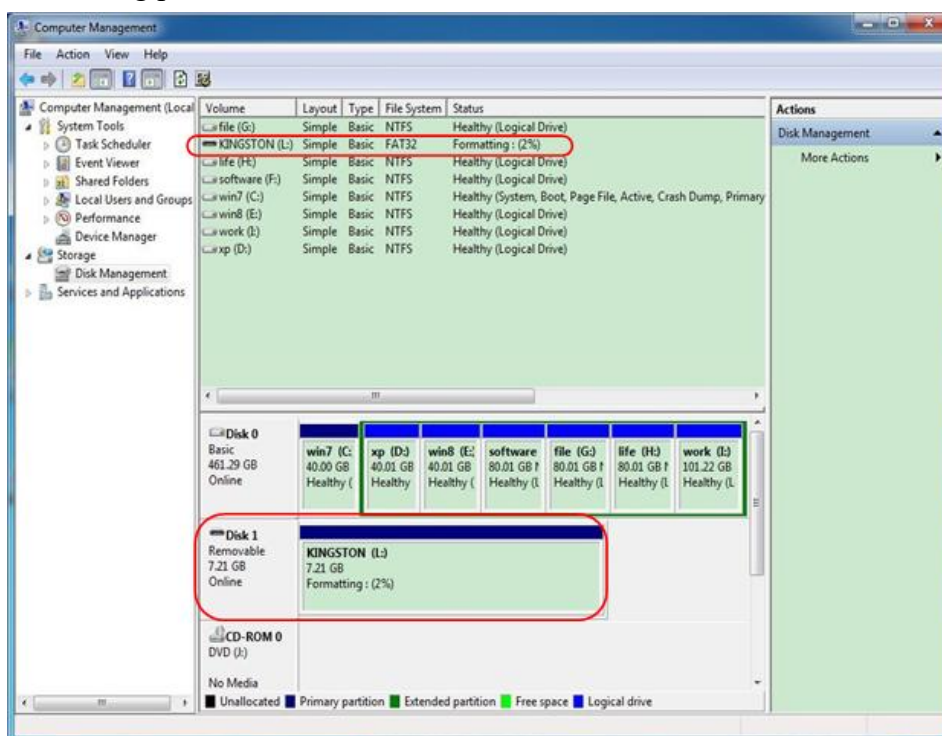

Figure 4- 5: Formatting the USB disk

7. Check whether the USB disk is FAT32 with allocation unit size 4096 after formatting.

### Use Minitool Partition Wizard to format

Download URL: <http://www.partitionwizard.com/free-partition-manager.html>

**Tip:** There are many tools for the USB disk formatting on the market, just take Minitool Partition Wizard for example here.

1. Connect the USB disk to the computer.
2. Open the software **Minitool Partition Wizard**.
3. Click **Reload Disk** on the pull-down menu at the top left or push keyboard F5, and information about the USB disk will display on the right side with red mark 1 and 2.

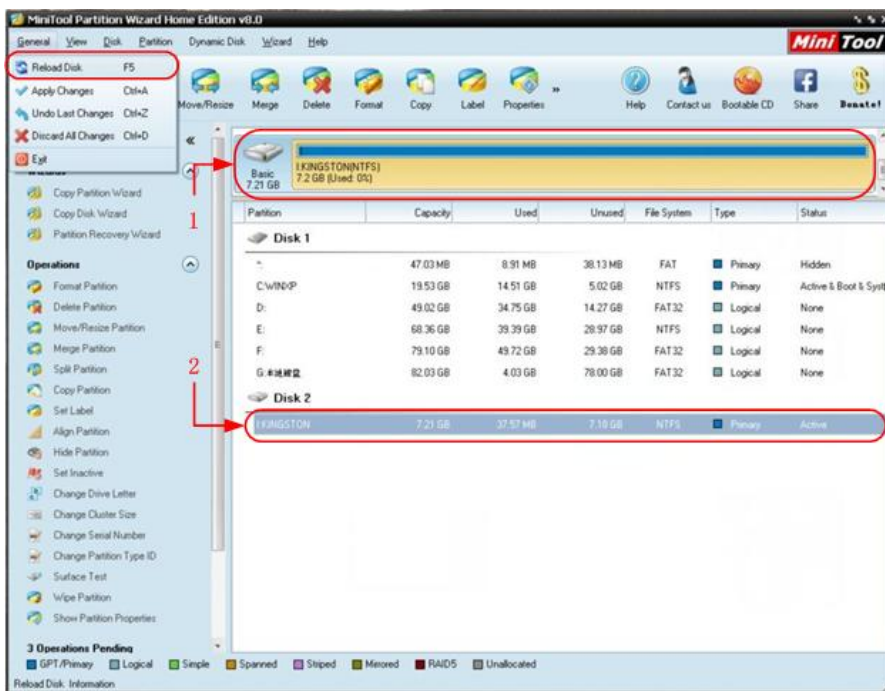

Figure 4-6: Reload Disk

- Right click 1 or 2 red mark area, choose **Format**.

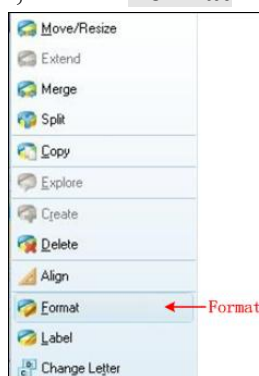

Figure 4-7: Choose format

- Set File System FAT32, Cluster size 4096. Click **OK**.



Figure 4-8: Format setting

- Click **Apply** at the top left of the menu. Then click **Yes** on the pop-up warning to begin formatting.

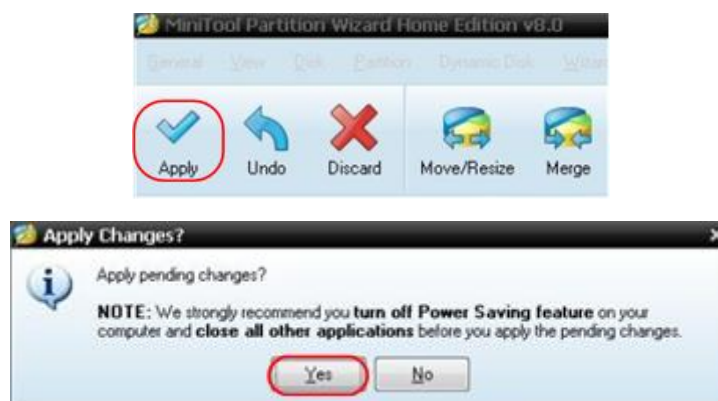

Figure 4-9: Apply setting

7. Formatting process

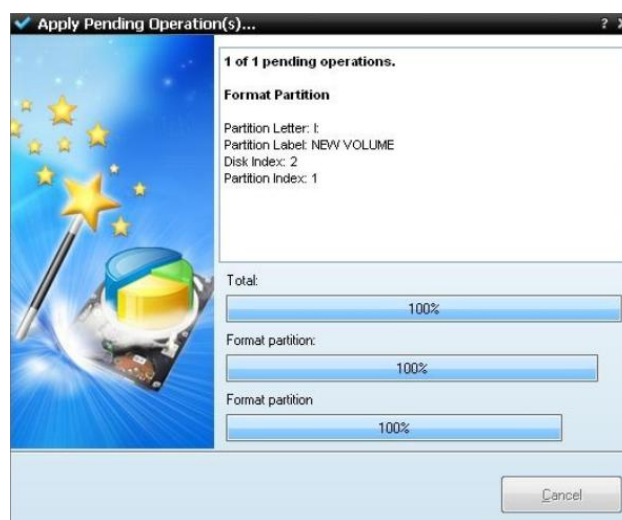

Figure 4-10: Format process

8. Format the USB disk successfully



Figure 4-11: Format successfully

## How to Record/Playback Waveforms

Wave Record function can record the input current wave. You can set the interval between recorded frames in the range of 10 ms - 10 s. The max frame number reaches 1000, and you can get better analysis effect with playback and storage function. The storage medium contains two kinds: Internal and External.

When the storage medium is Internal, Wave Record contains four modes: **OFF**, **Record**, **Playback** and **Storage**.

When storage medium is External, Wave Record contains two modes: **OFF**, **Record**.

**Record:** To record wave according to the interval until it reaches the end frame set.

Record menu (Internal Storage) shows as follows:

Menu	Setting	Instruction
Mode	OFF	Close wave record function.
	Record	Set record menu.
	Playback	Set playback menu.
	Storage	Set storage menu.
Record mode FrameSet	End frame	Turn the <b>M</b> knob to select the number of frames to record (1 - 1000).
	Interval	Turn the <b>M</b> knob to select the interval between recorded frames (10ms - 10s).
Refresh	ON	Refresh wave during recording.
	OFF	Stop refreshing.
Operate	Play	Begin to record.
	Stop	Stop recording.

**Note:**

Both of the waveforms of Channel 1 and Channel 2 will be recorded. If a Channel is turned off while recording, the waveform of the channel is invalid in the playback mode.

**Playback:** Play back the wave recorded or saved.

Playback menu shows as follows:

Menu	Setting	Instruction
Playback Mode FrameSet	Startframe	Turn the <b>M</b> knob to select the number of start frame to playback (1 - 1000).
	End frame	Turn the <b>M</b> knob to select the number of end frame to playback (1 - 1000).
	Cur frame	Turn the <b>M</b> knob to select the number of current frame to playback (1 - 1000).
	Interval	Turn the <b>M</b> knob to select the interval between played back frames (10ms - 10s).
Play mode	Loop	Play back the wave continuously.
	Once	Play back the wave just one time.
Operate	Play	Begin to record.
	Stop	Stop recording.

**Storage:** Save the current wave according to the start frame and end frame set.

Storage menu shows as follows:

Menu	Setting	Instruction
Storage Mode Frame Set	Startframe	Turn the <b>M</b> knob to select the number of start frame to store (1 - 1000).
	End frame	Turn the <b>M</b> knob to select the number of end frame to store (1 - 1000).
Save		Save the waveform record file to the internal memory.

Load		Load the waveform record file from the memory.
------	--	--

To use wave record function, do as follows:

- (1) Push **Save** button.
- (2) Select **Type** in the bottom menu, in the left menu, turn the **M** knob to select **Record**.
- (3) Select **Mode** in the bottom menu, select **OFF** in the right menu.
- (4) In the bottom menu, select **Storage** as **Internal**.
- (5) Select **Mode** in the bottom menu, select **Record** in the right menu.
- (6) Select **FrameSet** in the bottom menu, set **End frame** and **Interval** in the right menu.
- (7) In the bottom menu, set **Refresh**.
- (8) In the bottom menu, select **Operate** as **Play**.
- (9) Select **Mode** in the bottom menu, select **Playback** in the right menu. Set **FrameSet** and **Playmode**, select **Operate** as **Play**.
- (10) To save the wave recorded, select **Mode** in the bottom menu, select **Storage** in the right menu. Select **FrameSet** in the bottom menu to set the range of frames to store, select **Save** in the bottom menu.
- (11) To load the waveform from the internal memory, select **Load** in the bottom menu, then enter the **Playback** of the **Mode** to analyze the wave.

**Note:** When playing back the waveform, the sampling, trigger, or display function is not available.

**When storage medium is External, Wave Record contains two modes: OFF, Record.**

Record menu (External Storage) shows as follows:

Menu	Setting	Instruction
Mode	OFF Record	Close wave record function. Set record menu.
Record mode FrameSet	End frame	Turn the <b>M</b> knob to select the number of frames to record (1 - 900,000).
	Interval	Turn the <b>M</b> knob to select the interval between recorded frames (10ms - 10s).
	Infinity	Record infinitely until the storage medium is full.
Refresh	ON OFF	Refresh wave during recording. Stop refreshing.
Operate	Play Stop	Begin to record. Stop recording.

**Note:**

Both of the waveforms of Channel 1 and Channel 2 will be recorded. If a Channel is turned off while recording, the waveform of the channel is invalid in the playback mode.

To use wave record to external, do as follows:

1. Push **Save** button.
2. Select **Type** in the bottom menu, in the left menu, turn the **M** knob to select

**Record.**

3. Select **Mode** in the bottom menu, select **OFF** in the right menu.
4. In the bottom menu, select **Storage** as **External**.
5. Select **Mode** in the bottom menu, select **Record** in the right menu.
6. Select **FrameSet** in the bottom menu, set **End frame** and **Interval** in the right menu. If you want to record wave to external infinitely, select **Infinity** in the right menu, the End frame will display “-”.
7. In the bottom menu, set **Refresh**.
8. In the bottom menu, select **Operate** as **Play**.

**Connect external device to the computer, and *wave\_record\_0.bin* is the recorded file. Open the software, and do as follows to play back the waveform.**

1. Choose **Communications** → **Auto Player**.
2. Transform recording waveform from machine.
3. Add the well transformed files.
4. Set play mode and time delay.
5. Click the green button on the left corner to begin playing back the waveform.

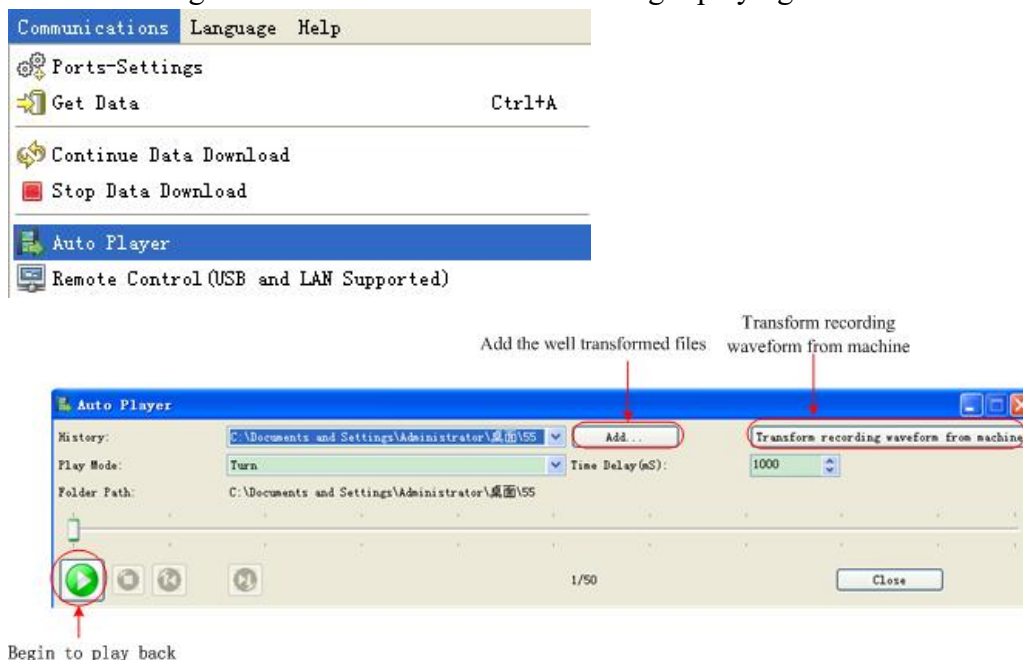

Figure 4- 12: Play back waveform by software

**How to Clone a waveform**

You can clone the waveform of one or both channels between two cursors, and save it in the internal memory or on a USB memory device. You can save four cloned waveforms in the instrument internal memory. The waveform files saved to a USB memory device are saved with the extension "ota".

**Clone Wave menu** shows as follows:

Menu	Setting	Instruction
Source	CH1	Clone the waveform of CH1.
	CH2	Clone the waveform of CH2.
	CH1&CH2	Clone the waveform of CH1 and CH2.



Line	a	Turn the <b>M</b> knob to move line a.	
	b	Turn the <b>M</b> knob to move line b.	
	ab	Two cursors are linked. Turn the <b>M</b> knob to move the pair of cursors.	
	x	Set the cursors to select the entire screen automatically.	
Save	Save	Save the waveform between two cursors.	
	Memory	Internal USB	Select the memory location.

#### To clone waveform and save to the internal/USB memory:

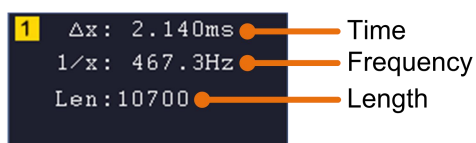
- (1) Push **Save** button.
- (2) Select **Type** in the bottom menu, in the left menu, turn the **M** knob to select **Clone**.
- (3) Select **Source** in the bottom menu, select one channel (**CH1/CH2**) or two channels (**CH1&CH2**) in the right menu for Source.
- (4) Select **Line** in the bottom menu. If **a** or **b** is selected, turn the **M** knob to move the cursor. If **ab** is selected, turn the **M** knob to move the pair of cursors. If **x** is selected, the entire screen will be selected automatically. The waveform information is displayed at the left bottom corner of the screen.



**Note:** If "Out Of Limits" appears in the information or a message "Waveform points beyond the limit." appears on the screen, that means the length of the cloned waveform exceeds the limit. When the source is CH1 or CH2, the maximum length is 2M; When the source is CH1&CH2, the maximum length is 1M. Push the **Acquire** button, select **Length** in the bottom menu, and set the record length to a smaller value.

- (5) Select **Save** in the bottom menu.
  - **To save the waveform to internal memory**, select **Storage** in the right menu as **Internal**. Turn the **M** knob to select an object in the left menu, select **Save** in the right menu.
  - **To save the waveform onto a USB memory device**, insert a USB memory device into the port on the front panel. If the icon  appears on the top right of the screen, the USB memory device is installed successfully. If the USB memory device cannot be recognized, format the USB memory device according to the methods in "USB disk Requirements" on P59. Select **Storage** in the right menu as **External**. Select **Save** in the right menu. An input keyboard used to edit the file name will pop up. The name is default as current system date and time. Turn the **M** knob to select the keys, push the knob to input. Select the  key in the keyboard to confirm. The cloned waveform will be saved onto the USB memory device as a file with the ota suffix.



**Data format description of OTA waveform file**

If the source is CH1 or CH2, OTA file consists of two parts: the file header and the data. If the source is CH1&CH2, OTA file consists of three parts: file header, CH1data, and CH2 data. The file header represents the parameter of file data, which is expressed in "parameter name + value". Each parameter name is a case-sensitive string of 4 bytes. The parameter value is at least 4 bytes.

**1.Format description of the file header:****1) HEAD**

Parameter name	Meaning	Value	Comment
HEAD	Header size	4 bytes int	

**2) TYPE**

Parameter name	Meaning	Value	Comment
TYPE	Model	12 bytes char	

**3) BYTE**

Parameter name	Meaning	Value	Comment
BYTE	Data length in bit	4 bytes int	

**4) SIZE**

Parameter name	Meaning	Value	Comment
SIZE	File size	4 bytes int	Used to check the file integrity

**5) VOLT**

Parameter name	Meaning	Value	Comment
VOLT	Voltage division, divided by 400 is ADC resolution. (When the source is CH1&CH2, it is CH1 voltage division.)	4 bytes float	The value indicates voltage (the unit is mV), such as 200 mV.

**6) SAMP**

Parameter name	Meaning	Value	Comment
SAMP	Sample rate	4 bytes float	The unit is Sa/s.

**7) ADCB**

Parameter name	Meaning	Value	Comment
ADCB	ADC bit, ADC resolution	4 bytes int	8-bit or 12-bit

**8) CHAN**

Parameter name	Meaning	Value	Comment
CHAN	Number of channels	4 bytes int	1 or 2

**9) VOL2**

Parameter name	Meaning	Value	Comment
VOL2	Voltage division, divided by 400 is ADC resolution. (When the source is CH1&CH2, it is CH2 voltage division.)	4 bytes float	The value indicates voltage (the unit is mV), such as 200 mV.

**2.Data**

The data type is signed integer. You can determine the data type (**char**, **short int** or **int**) based on the **BYTE** parameter. The valid range is determined by the **ADCB** parameter, e.g. the valid range for 8-bit ADC is -127 to +127.

**How to Implement the Auxiliary System Function Setting****●Configure**

Push the **Utility** button, select **Function** in the bottom menu, select **Configure** in the left menu.

The description of **Configure Menu** is shown as the follows:

Function Menu	Setting	Description
Language		Choose the display language of the operating system.
Set Time (Only model with A)	Display    ON OFF	On/Off the date display.
	Hour    Min	Setting Hour/Minute.
	Day    Month	Setting Date/Month.
	Year	Setting Year.
KeyLock		Lock all keys. Unlock method: push <b>Trigger Menu</b> button in trigger control area, then push <b>Force</b> button, repeat 3 times.
About		Version number and serial number showing.

**●Display**

Push the **Utility** button, select **Function** in the bottom menu, select **Display** in the left menu.

The description of **Display Menu** is shown as the follows:

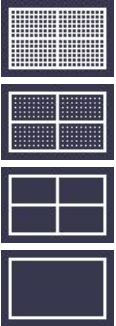
Function Menu	Setting	Description
BackLight	0% - 100%	Turn the <b>M</b> knob to adjust the backlight.
Graticule		Select the grid type.
Menu Time	OFF, 5s - 30s	Set the disappear time of menu.

## ● Adjust

Push the **Utility** button, select **Function** in the bottom menu, select **Adjust** in the left menu.

The description of **Adjust Menu** is shown as the follows:

Function Menu	Description
Self Cal	Carry out the self-calibration procedure.
Default	Call out the factory settings.
ProbeCh.	Check whether probe attenuation is good.

### Do Self Cal (Self-Calibration)

The self-calibration procedure can improve the accuracy of the oscilloscope under the ambient temperature to the greatest extent. If the change of the ambient temperature is up to or exceeds 5°C, the self-calibration procedure should be executed to obtain the highest level of accuracy.

Before executing the self-calibration procedure, disconnect all probes or wires from the input connector. Push the **Utility** button, select **Function** in the bottom menu, the function menu will display at the left, select **Adjust**. If everything is ready, select **Self Cal** in the bottom menu to enter the self-calibration procedure of the instrument.

### Probe checking

To check whether probe attenuation is good. The results contain three circumstances: Overflow compensation, Good compensation, Inadequate compensation. According to the checking result, users can adjust probe attenuation to the best. Operation steps are as follows:

1. Connect the probe to CH1, adjust the probe attenuation to the maximum.
2. Push the **Utility** button, select **Function** in the bottom menu, select **Adjust** in the left menu.
3. Select **ProbeCh.** in the bottom menu, tips about probe checking shows on the screen.

4. Select **ProbeCh.** again to begin probe checking and the checking result will occur after 3s; push any other key to quit.

- **Pass/Fail**

The **Pass/Fail** function monitors changes of signals and output pass or fail signals by comparing the input signal that is within the pre-defined mask.

Push the **Utility** button, select **Function** in the bottom menu, select **Pass/fail** in the left menu.

The description of **Pass/fail Menu** is shown as the follows:

Function Menu	Setting	Description
Operate	Enable	Control enable switch.
	Operate	Control operate switch.
Output	Pass	Signal tested corresponds with the rule.
	Fail	Signal tested not correspond with the rule.
	Beep	Beep when it satisfies the rule.
	Stop	Stop once satisfying the rule.
	Info	Control the display status of info frame.
Rule	Source	Select source CH1, CH2 or Math.
	Horizontal	Change the Horizontal tolerance value by turning the <b>M</b> knob.
	Vertical	Change the Vertical tolerance value by turning the <b>M</b> knob.
	Create	Use the rule set as testing rule.
SaveRule	Number	Select any one from Rule1 - Rule8 as your rule name.
	Save	Select <b>Save</b> to save the rule.
	Load	Load some rule as the testing rule.

**Pass/Fail test:**

Detect whether the input signal is within the limits of the rule, if it exceeds limits of the rule, it is "Fail"; otherwise it is "Pass". Also it can output fail or pass signal by built-in and configurable output port. To run the test, read the following steps:

1. Push the **Utility** button, select **Function** in the bottom menu, select **Pass/fail** in the left menu.
2. **Enable switch on:** Select **Operate** in the bottom menu, select **Enable** in the right menu as **ON**.
3. **Create rule:** Select **Rule** in the bottom menu. Select **Source** in the right menu, select the source in the left menu. Set **Horizontal** tolerance and **Vertical** tolerance in the right menu. Select **Create** in the right menu to create the rule.
4. **Set output type:** Select **Output** in the bottom menu to enter output option setting. Choose any one or two of the options "**Pass**", "**Fail**" or "**Beep**". "**Pass**" and "**Fail**" are mutually exclusive options, which could not be chosen simultaneously. "**Stop**" means stop once the condition satisfies your setting.
5. **Begin to test:** Select **Operate** in the bottom menu, select **Operate** in the right menu as **Start**, the test will begin.

6. **Save rule:** Select **SaveRule** in the bottom menu. Select the save location in the left menu, and then select **Save** in the right menu to save the rules, which could be called up at once when need. Select **Load** to call up the rule saved.

**Note:**

1. When Pass/Fail is ON, if XY or FFT is ready to run, then Pass/Fail will be closed; under the mode of XY or FFT, Pass/Fail is unable.
2. Under the mode of Factory, Auto Scale and Auto Set, Pass/Fail will be closed.
3. When no save setting left in the rule save, tip will be given to show "NO RULE SAVED".
4. Under the status of stop, data comparing will stop, and when it goes on running, the number of Pass/Fail will increase from the former number, not from zero.
5. When the waveform playback mode is on, Pass/Fail is used to test the played-back waveform specially.

● **Output**

Push the **Utility** button, select **Function** in the bottom menu, select **Output** in the left menu.

**Output** menu item in the bottom menu sets the output type of Trig Out(P/F) port in Figure 3-3 Rear Panel on P6. In the bottom menu, select **Output**. The description of **Output menu** is shown as the follows:

Function Menu	Setting	Description
Type	TrigOut	Output trig signal synchronously.
	Pass/fail	Output High Level when Pass , and Low Level when Fail.
VGA	ON OFF	Select "ON" to open the VGA function.
Device	PC PICT USBTMC	Select the device you need.

**Video** menu item in the bottom menu sets the output port of video. In the bottom menu, select **Video**. The description of **Video menu** is shown as the follows:

Function Menu	Setting	Description
Video (Only model with A)	OFF	Turn off video output
	VGA	Connect the VGA or AV port to an external monitor or projector. Select the port in this menu, the oscilloscope display can be shown on an external monitor or projector.
	AV	

**Device** and **Print Setup** menu items set the print output, refer to "How to Print the Screen Image" on page 86.

● **LAN Set**

Using the LAN port, the oscilloscope can be connected with a computer. Refer to

"*Communication with PC*" on page 87 for the operation steps.

## ● Update

Use the front-panel USB port to update your instrument firmware using a USB memory device. Refer to "*How to Update your Instrument Firmware*" on page 73.

## How to Update your Instrument Firmware

Use the front-panel USB port to update your instrument firmware using a USB memory device.

**USB memory device requirements:** Insert a USB memory device into the USB port on the front panel. If the icon  appears on the top right of the screen, the USB memory device is installed successfully. If the USB memory device cannot be detected, format the USB memory device according to the methods in "*USB disk Requirements*" on P59.

**Caution:** Updating your instrument firmware is a sensitive operation, to prevent damage to the instrument, do not power off the instrument or remove the USB memory device during the update process.

### To update your instrument firmware, do the following:

1. Push the **Utility** button, select **Function** in the bottom menu, select **Configure** in the left menu, select **About** in the bottom menu. View the model and the currently installed firmware version.
2. From a PC, visit the website and check if the website offers a newer firmware version. Download the firmware file. The file name must be \*.update. The file name can be up to 15 characters long (including the suffix). Copy the firmware file onto your USB memory device.
3. Insert the USB memory device into the front-panel USB port on your instrument.
4. Push the **Utility** button, select **Function** in the bottom menu, select **Update** in the left menu.
5. Select **Open** in the bottom menu, the instrument lists a directory of the folders on the USB memory device. Turn the **M** knob to select a folder, select **Open** in the bottom menu to enter the folder. Navigate to the folder where the firmware file is, and select the file with the .update suffix.
6. In the bottom menu, select **Open**, the messages below will be shown.

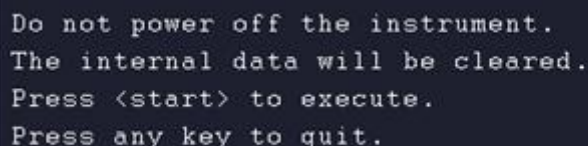

```
Do not power off the instrument.  
The internal data will be cleared.  
Press <start> to execute.  
Press any key to quit.
```

7. In the bottom menu, select **Start** again, the interfaces below will be displayed in sequence. The update process will take up to three minutes. After completion, the instrument will be shut down automatically.

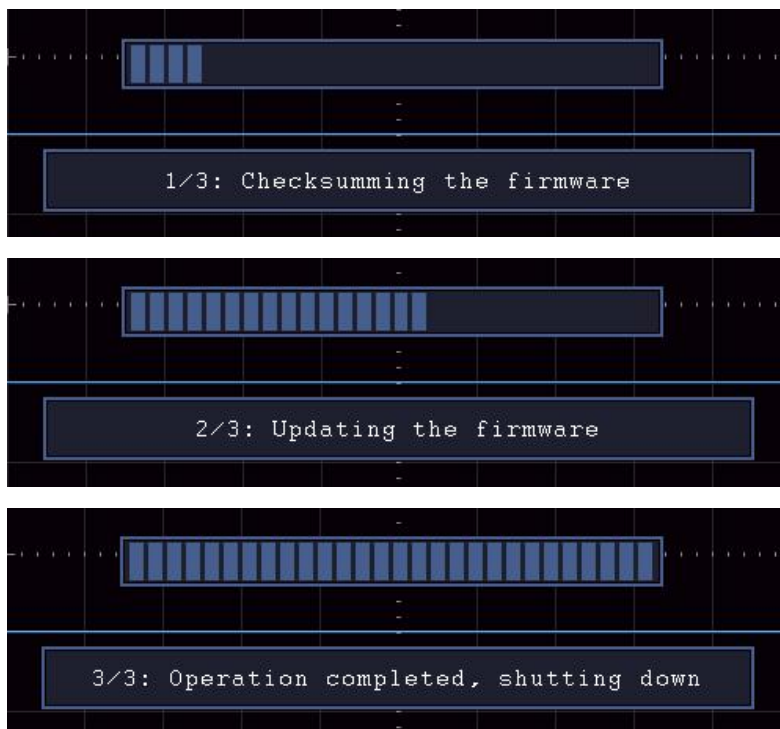

8. Long press the  button to power on the instrument.

## How to Measure Automatically

Push the **Measure** button to display the menu for the settings of the Automatic Measurements. At most 8 types of measurements could be displayed on the bottom left of the screen.

The oscilloscopes provide 38 parameters for auto measurement, including Max, Min, PK-PK, Top, Base, Amplitude, Mean, RMS, Cycle RMS, Cursor RMS, Overshoot, Preshoot, Period, Frequency, Rise Time, Fall Time, +PulseWidth, -PulseWidth, +Duty Cycle, -Duty Cycle, Screen Duty, FRR, FRF, FFR, FFF, LRR, LRF, LFR, LFF, Delay A→B  $\Phi$ , Delay A→B  $\Psi$ , Phase, +PulseCount, -PulseCount, RiseEdgeCnt, FallEdgeCnt, Area, Cycle Area.

The "Automatic Measurements" menu is described as the following table:

Function Menu		Setting	Description
Add	Meas Type (left menu)		Select the measure types.
	Source	CH1	Select the source.
		CH2	
Add		Add the selected measure types (shown at the left bottom, you could only add 8 types at most).	
Remove	Meas Type (left menu)		Select the types need to be deleted.

	Remove		Remove the chosen measure type.
	Remove All		Remove all the measures.
Show CH1	ON OFF	Show all the measures of CH1 on the screen. Hide the window of CH1 measures.	
Show CH2	ON OFF	Show all the measures of CH2 on the screen. Hide the window of CH2 measures.	
Configure	Gating	Screen Cursor	Choose “Screen” or “Cursor” to set cursor range.
	Statistics	ON OFF	Choose “ON” to open measurement value statistics.
	Statistics Sel	Extremum Difference	Choose “Extremum” or “Difference” to statistic selection.
	Std Dev Samples		Select the desired number of samples by turning the universal knob.
	Reset		Restart the statistics for the statistics

## Measure

Only if the waveform channel is in the ON state, the measurement can be performed. The automatic measurement can not be performed in the following situation: 1) On the saved waveform. 2) On the Dual Wfm Math waveform. 3) On the Video trigger mode.

On the Scan format, period and frequency can not be measured.

Measure the period, the frequency of the CH1, following the steps below:

1. Push the **Measure** button to show the automatic measurement function menu.
2. Select **Add** in the bottom menu.
3. In the right menu, select **CH1** in the **Source** menu item.
4. In the left Type menu, turn the **M** knob to select **Period**.
5. In the right menu, select **Add**. The period type is added.
6. In the left Type menu, turn the **M** knob to select **Frequency**.
7. In the right menu, select **Add**. The frequency type is added.

The measured value will be displayed at the bottom left of the screen automatically (see *Figure 4-13*).



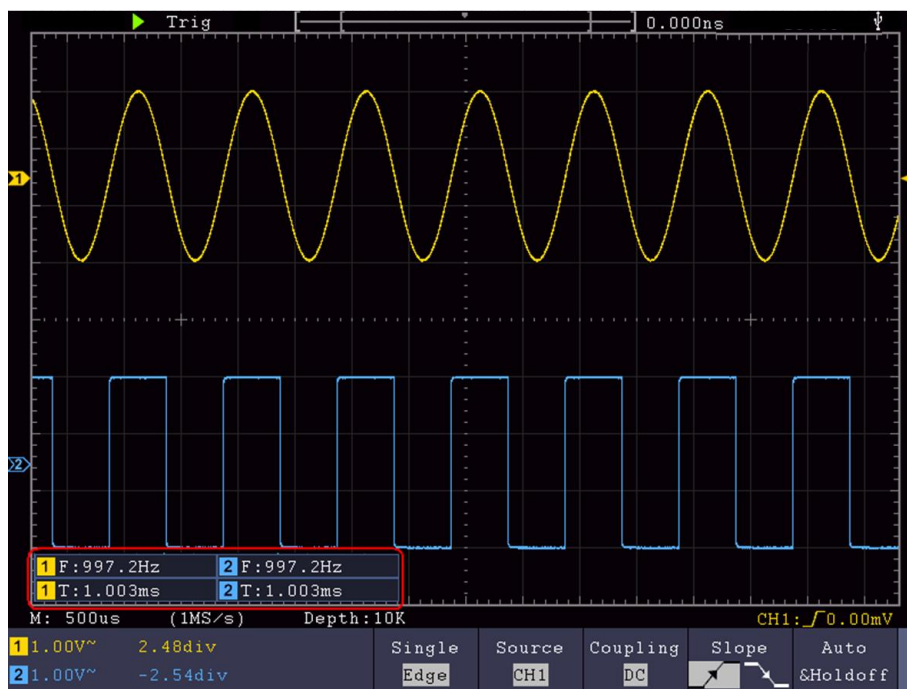

Figure 4- 13 Automatic measurement

### The automatic measurement of voltage parameters

The oscilloscopes provide automatic voltage measurements including Mean, PK-PK, RMS, Max, Min, Vtop, Vbase, Vamp, OverShoot, PreShoot, Cycle RMS, and Cursor RMS. *Figure 4- 14* below shows a pulse with some of the voltage measurement points.

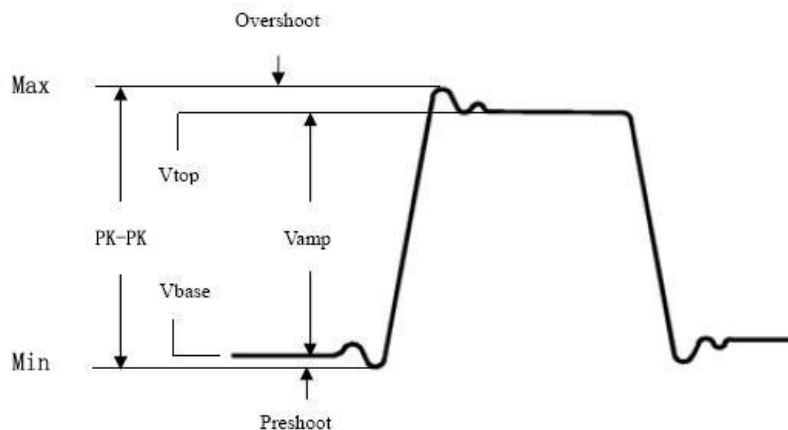

Figure 4- 14

**Mean:** The arithmetic mean over the entire waveform.

**PK-PK:** Peak-to-Peak Voltage.

**RMS:** The true Root Mean Square voltage over the entire waveform.

**Max:** The maximum amplitude. The most positive peak voltage measured over the entire waveform.

**Min:** The minimum amplitude. The most negative peak voltage measured over the entire waveform.

- Top:** Voltage of the waveform's flat top, useful for square/pulse waveforms.
- Vbase:** Voltage of the waveform's flat base, useful for square/pulse waveforms.
- Amplitude:** Voltage between Vtop and Vbase of a waveform.
- Overshoot:** Defined as  $(V_{max}-V_{top})/V_{amp}$ , useful for square and pulse waveforms.
- Preshoot:** Defined as  $(V_{min}-V_{base})/V_{amp}$ , useful for square and pulse waveforms.
- Cycle RMS:** The true Root Mean Square voltage over the first entire period of the waveform.
- Cursor RMS:** The true Root Mean Square voltage over the range of two cursors.

### The automatic measurement of time parameters

The oscilloscopes provide time parameters auto-measurements include Period, Frequency, Rise Time, Fall Time, +D width, -D width, +Duty, -Duty, Delay A→B  $\Phi$ , Delay A→B  $\Psi$ , Duty cycle, FRR,FRF,FFR,FFF,LRR,LRF,LFR,LFF.

Figure 4- 15 shows a pulse with some of the time measurement points.

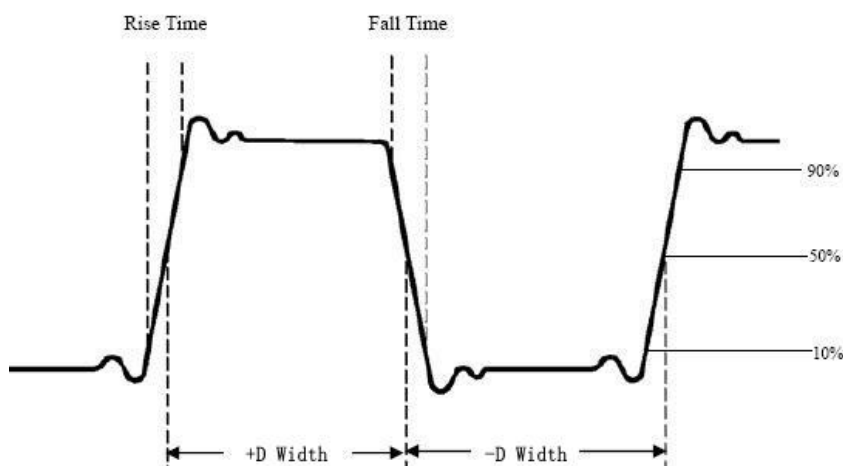

Figure 4- 15

**Rise Time:** Time that the leading edge of the first pulse in the waveform takes to rise from 10% to 90% of its amplitude.

**Fall Time:** Time that the falling edge of the first pulse in the waveform takes to fall from 90% to 10% of its amplitude.

**+PluseWidth:** The width of the first positive pulse in 50% amplitude points.

**-PluseWidth:** The width of the first negative pulse in the 50% amplitude points.

**+Duty Cycle:** +Duty Cycle, defined as +Width/Period.

**-Duty Cycle:** -Duty Cycle, defined as -Width/Period.

**Delay A→B  $\Phi$ :** The delay between the two channels at the rising edge.

**Delay A→B  $\Psi$ :** The delay between the two channels at the falling edge.

**Screen Duty:** Defines as (the width of the positive pulse)/(Entire period)

**Phase:** Compare the rising edge of CH1 and CH2, calculate phase difference of two channels.

**Phase difference**=(Delay between channels at the rising edge÷Period)×360° .

**Note for the following delay measurements:**

**When the Source in menu is set to CH1, the Source 1 is CH1, the Source 2 is CH2.**

**When the Source in menu is set to CH2, the Source 1 is CH2, the Source 2 is CH1.**

**FRR: Time between Source 1 first rising edge and Source 2 first rising edge.**

**FRF: Time between Source 1 first rising edge and Source 2 first falling edge.**

**FFR: Time between Source 1 first falling edge and Source 2 first rising edge.**

**FFF: Time between Source 1 first falling edge and Source 2 first falling edge.**

**LRR: Time between Source 1 first rising edge and Source 2 last rising edge.**

**LRF: Time between Source 1 first rising edge and Source 2 last falling edge.**

**LFR: Time between Source 1 first falling edge and Source 2 last rising edge.**

**LFF: Time between Source 1 first falling edge and Source 2 last falling edge.**

## Other measurements

**+PulseCount** : The number of positive pulses that rise above the mid reference crossing in the waveform.

**-PulseCount** : The number of negative pulses that fall below the mid reference crossing in the waveform.

**RiseEdgeCnt** : The number of positive transitions from the low reference value to the high reference value in the waveform.

**FallEdgeCnt** : The number of negative transitions from the high reference value to the low reference value in the waveform.

**Area** : The area of the whole waveform within the screen and the unit is voltage-second. The area measured above the zero reference (namely the vertical offset) is positive; the area measured below the zero reference is negative. The area measured is the algebraic sum of the area of the whole waveform within the screen.

**Cycle Area** : The area of the first period of waveform on the screen and the unit is voltage-second. The area above the zero reference (namely the vertical offset) is positive and the area below the zero reference is negative. The area measured is the algebraic sum of the area of the whole period waveform.

Note: When the waveform on the screen is less than a period, the period area measured is 0.

## How to customize an automatic measurement

You can customize automatic measurements by using gating and statistics.

### Gating

1. Press the **Measure** button, and the automatic measurement function menu is displayed at the bottom of the screen;
2. Press the **Set** softkey at the bottom of the screen, the setting menu appears on the right side of the screen;
3. Select the **Gating** menu. There are two menus: **Screen** and **Cursor** under the range. Click the Screen and then click the Cursor, or press the right Screen menu button twice to set the cursor range.

## How to Measure with Cursors

Push the **Cursor** button to turn cursors on and display the cursor menu. Push it again to turn cursors off.

### The Cursor Measurement for normal mode:

The description of the **cursor menu** is shown as the following table:

Function Menu	Setting	Description
Type	Voltage Time Time&Voltage AutoCursr	Display the voltage measurement cursor and menu. Display the time measurement cursor and menu. Display the time and voltage measurement cursor and menu. The horizontal cursors are set as the intersections of the vertical cursors and the waveform.
Line Type (Time&Voltage type)	Time Voltage	Makes the vertical cursors active. Makes the horizontal cursors active.
Window (Wave zoom mode)	Main Extension	Measure in the main window. Measure in the extension window.
Line	a b ab	Turn the <b>M</b> knob to move line a. Turn the <b>M</b> knob to move line b. Two cursors are linked. Turn the <b>M</b> knob to move the pair of cursors.
Source	CH1 CH2	Display the channel to which the cursor measurement will be applied.

Perform the following operation steps for the time and voltage cursor measurement of the channel CH1:

1. Push **Cursor** to display the cursor menu.
2. In the bottom menu, select **Source** as **CH1**.
3. Select the first menu item in the bottom menu, the **Type** menu will display at the right of the screen. In the right menu, select **Time&Voltage** for Type, two blue dotted lines displayed along the horizontal direction of the screen, two blue dotted lines displayed along the vertical direction of the screen. Cursor measure window at the left bottom of the screen shows the cursor readout.
4. In the bottom menu, select **Line Type** as **Time** to make the vertical cursors active. If the **Line** in the bottom menu is select as **a**, turn the **M** knob to move line a to the right or left. If **b** is selected, turn the **M** knob to move line b.
5. In the bottom menu, select **Line Type** as **Voltage** to make the horizontal cursors active. Select **Line** in the bottom menu as **a** or **b**, turn the **M** knob to move it.
6. Push the **Horizontal HOR** button to enter wave zoom mode. In the bottom cursor menu, select **Window** as **Main** or **Extension** to make the cursors shown in the main window or zoom window.

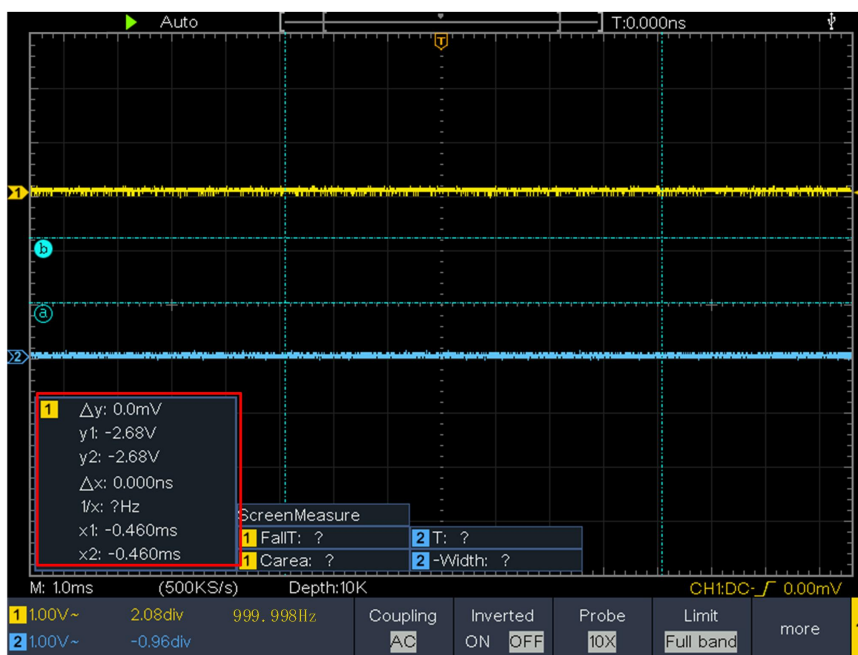
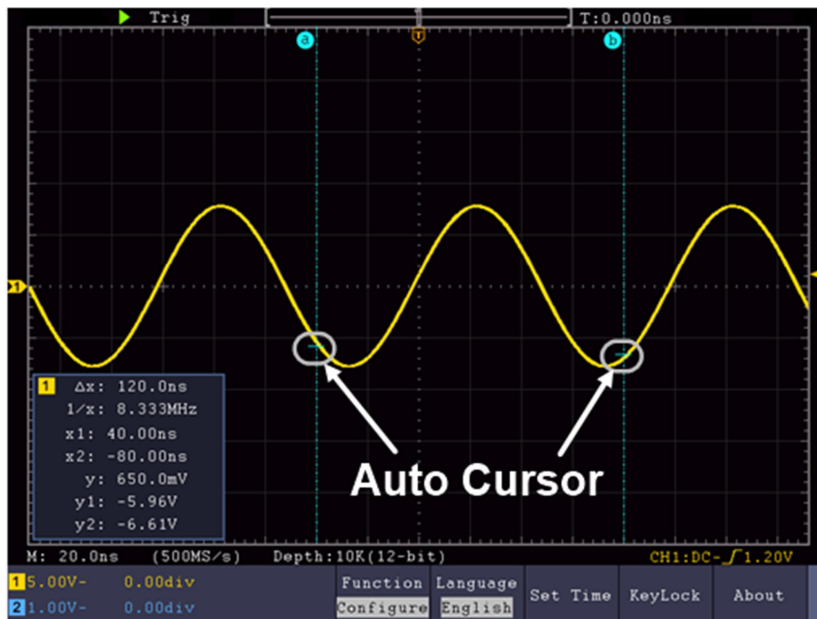

Figure 4- 16 Time&amp;Voltage Cursor Measurement

### Auto Cursor

For the AutoCursr type, the horizontal cursors are set as the intersections of the vertical cursors and the waveform.



### Move the cursors by gestures

About the gestures for moving cursors, see "*Other Operations Using Touchscreen*" on P22.

### The Cursor Measurement for FFT mode

In FFT mode, push the **Cursor** button to turn cursors on and display the cursor menu.

The description of the **cursor menu** in FFT mode is shown as the following table:

Function Menu	Setting	Description
Type	Vamp (or Phase)	Display the Vamp (or Phase) measurement cursor and menu.
	Freq	Display the Freq measurement cursor and menu.
	Freq&Vamp (or Freq&Phase)	Display the corresponding measurement cursor and menu.
	AutoCursor	The horizontal cursors are set as the intersections of the vertical cursors and the waveform.
Line Type (Freq&Vamp or Freq&Phase type)	Freq	Makes the vertical cursors active.
	Vamp (or Phase)	Makes the horizontal cursors active.
Window (Wave zoom mode)	Main	Measure in the main window.
	Extension	Measure in the FFT extension window.
Line	a	Turn the <b>M</b> knob to move line a.
	b	Turn the <b>M</b> knob to move line b.

	ab	Two cursors are linked. Turn the <b>M</b> knob to move the pair of cursors.
Source	Math FFT	Display the channel to which the cursor measurement will be applied.

Perform the following operation steps for the amplitude and frequency cursor measurement of math FFT:





1. Press the **Math** button to display the math menu in the bottom. Select **FFT**. In the right menu, select **Format**. In the left menu, turn the **M** knob to select amplitude unit (**V RMS** or **Decibels**).
2. Push **Cursor** to display the cursor menu.
3. In the bottom menu, select **Window** as **Extension**.
4. Select the first menu item in the bottom menu, the **Type** menu will display at the right of the screen. In the right menu, select **Freq&Vamp** for Type, two blue dotted lines displayed along the horizontal direction of the screen, two blue dotted lines displayed along the vertical direction of the screen. Cursor measure window at the left bottom of the screen shows the cursor readout.
5. In the bottom menu, select **Line Type** as **Freq** to make the vertical cursors active. If the **Line** in the bottom menu is select as **a**, turn the **M** knob to move line a to the right or left. If **b** is selected, turn the **M** knob to move line b.
6. In the bottom menu, select **Line Type** as **Vamp** to make the horizontal cursors active. Select **Line** in the bottom menu as **a** or **b**, turn the **M** knob to move it.
7. In the bottom cursor menu, you can select **Window** as **Main** to make the cursors shown in the main window.

## How to Use Autoscale



This is a very useful function for first time users to carry out a simple and quick test on the input signal. The function is applied to follow-up signals automatically even if the signals change at any time. Autoscale enables the instrument to set up trigger mode, voltage division and time scale automatically according to the type, amplitude and frequency of the signals.

The menu is as follows:

Function Menu	Setting	Instruction
Autoscale	ON	Turn on Autoscale.
	OFF	Turn off Autoscale.

Mode		Follow-up and adjust both vertical and horizontal settings.
		Follow-up and only adjust horizontal scale.
		Follow-up and only adjust vertical scale.
Wave		Show Multi-period waveforms.
		Only show one or two periods.

If you want to measure the two-channel signal, you can do as the follows:

1. Push the **Autoscale** button, the function menu will appear.
2. In the bottom menu, select **ON** in the **Autoscale** menu item.
3. In the bottom menu, Select **Mode**. In the right menu, select .
4. In the bottom menu, Select **Wave**. In the right menu, select .

Then the wave is displayed in the screen, shown as *Figure 4- 17*.

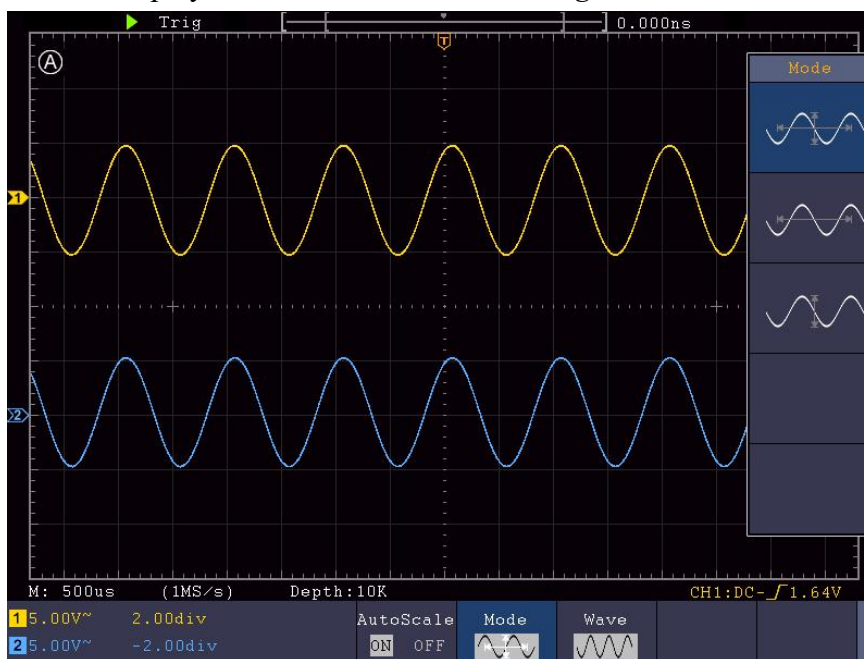

Figure 4- 17 Autoscale Horizontal-Vertical multi-period waveforms

**Note:**

1. Entering into Autoscale function and the symbol **(A)** will be flickering on the top left of the screen.
2. In the mode of Autoscale, the oscilloscope can self-estimate Trigger Mode (Edge, Video). At this point, the trigger menu is not available.
3. At the mode of XY and STOP status, when entering into Autoscale, DSO switches to YT mode and AUTO triggering.
4. At the mode of Autoscale, DSO is always set as DC coupling with AUTO



triggering.

5. At the mode of Autoscale, if adjust the vertical position, voltage division, trigger level or time scale of CH1 or CH2, the oscilloscope will turn off Autoscale function. To back to Autoscale, Push **Autoset**.
6. Turn off the submenu at the Autoscale menu, the Autoscale is off and turn on the submenu still enters into the function.
7. When video triggering, the horizontal time scale is 50us. If one channel is showing edge signal, the other channel is showing video one, the time scale refers to 50us as video one as standard.
8. While the Autoscale is working, the settings below will be made forcibly:  
The DSO will switch from the wave zoom mode to the normal mode.

## How to Use Built-in Help

1. Push **Help** button, the catalog will display in the screen.
2. In the bottom menu, press **Prev Page** or **Next Page** to choose help topic, or just turn the **M** knob to choose.
3. Press **OK** to view the details about the topic, or just push the M knob.
4. Press **Quit** to exit the help, or just do other operations.

## How to Use Executive Buttons

Executive Buttons include **Autoset**, **Run/Stop**, **Single**, **Copy**.

### Autoset

It's a very useful and quick way to apply a set of pre-set functions to the incoming signal, and display the best possible viewing waveform of the signal and also works out some measurements for user as well.

The details of functions applied to the signal when using **Autoset** are shown as the following table:

Function Items	Setting
Vertical Coupling	Current
Channel Coupling	Current
Vertical Scale	Adjust to the proper division.
Bandwidth	Full
Horizontal Level	Middle or $\pm 2$ div
Horizontal Sale	Adjust to the proper division
Trigger Type	Slope or Video
Trigger Source	CH1 or CH2
Trigger Coupling	DC
Trigger Slope	Current
Trigger Level	3/5 of the waveform
Trigger Mode	Auto
Display Format	YT
Force	Stop

Help	Exit
Pass/Fail	Off
Inverted	Off
Zoom Mode	Exit

## Judge waveform type by Autoset

Five kinds of types: Sine, Square, video signal, DC level, Unknown signal.

Menu as follow:

Sine: (Multi-period, Single-period, FFT, Cancel Autoset)



Square: (Multi-period, Single-period, Rising Edge, Falling Edge, Cancel Autoset)



Video signal:

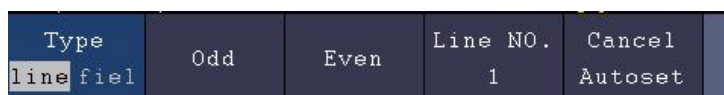

DC level, Unknown signal:

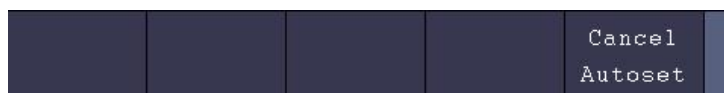

### Description for some icons:

- Multi-period: To display multiple periods
- Single-period: To display single period
- FFT: Switch to FFT mode
- Rising Edge: Display the rising edge of square waveform
- Falling Edge: Display the falling edge of square waveform
- Cancel Autoset: Go back to display the upper menu and waveform information

**Note:** The Autoset function requires that the frequency of signal should be no lower than 20Hz, and the amplitude should be no less than 5mv. Otherwise, the Autoset function may be invalid.

**Run/Stop:** Enable or disable sampling on input signals.

Notice: When there is no sampling at STOP state, the vertical division and the horizontal time base of the waveform still can be adjusted within a certain range, in other words, the signal can be expanded in the horizontal or vertical direction.

When the horizontal time base is  $\leq 50\text{ms}$ , the horizontal time base can be expanded for 4 divisions downwards.

**Single:** Push this button you can set the trigger mode as single directly, so when trigger occurs, acquire one waveform then stop.

**Copy:** You can save the waveform by just pushing the **Copy** panel button in any user interface. The source wave and the storage location are according to the settings of the **Save** function menu when the Type is **Wave**. For more details, please see "*Save Function Menu*" on P56.

### How to Print the Screen Image

To print an image of what appears on the oscilloscope screen, do as the follows:

- (1) Connect the printer to the **USB Device port** on the rear panel of the oscilloscope.  
Note: The USB Device port supports PictBridge compatible printers.
- (2) Push the **Utility** button, select **Function** in the bottom menu, select **Output** in the left menu.
- (3) In the bottom menu, select **Device** as **PICT**. (When **PC** is selected, you can get an image by Oscilloscope software.)
- (4) In the bottom menu, select **Print Setup**. In the right menu, set up print parameters. The **On** selection of **Ink Saver** will print out a copy with a white background.
- (5) Once you have connected a printer to your oscilloscope and set up print parameters, you can print current screen images with a single push of the **Print** button on the front panel.

## 5. Communication with PC

The oscilloscope supports communications with a PC through USB or LAN port. You can use the Oscilloscope communication software to store, analyze, display the data and remote control.

For the specific operation method of Oscilloscope host software, please download and view the host help document on our download website.

Here's how to connect to a computer. Please get the host software installation package on your computer from our official website, double-click it, and click according to the prompts until the installation is complete. Then, there are several connections you can choose from.

### Using USB Port

- (1) **Set the USB device protocol type of the instrument:** Click Utility → Function → Function → Output → Device ,switch to PC.
- (2) **Connection:** Use a USB data cable to connect the **USB Device port** in the right panel of the Oscilloscope to the USB port of a PC.
- (3) **Port setting of the software:** Run the Oscilloscope software; click "Communications" on the menu bar, choose "Ports-Settings", in the setting dialog, choose "Connect using" as "USB". After connect successfully, the connection information in the bottom right corner of the software will turn green.

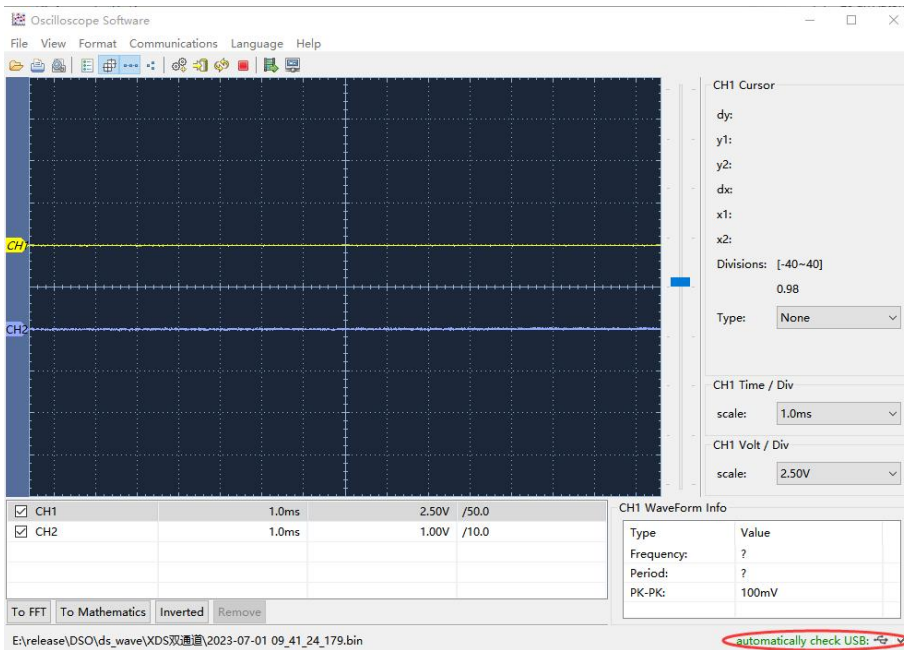

Figure 5- 1 Connect with PC through USB port

## Using LAN Port

### Connect directly

- (1) **Connection.** Plug in the LAN cable to the LAN port in the back of the oscilloscope; plug the other end into the LAN interface of the computer.
- (2) **Set the network parameters of the computer.** Since the oscilloscope can not support obtaining an IP address automatically, you should assign a static IP address. Here we set the IP address to 192.168.1.71.

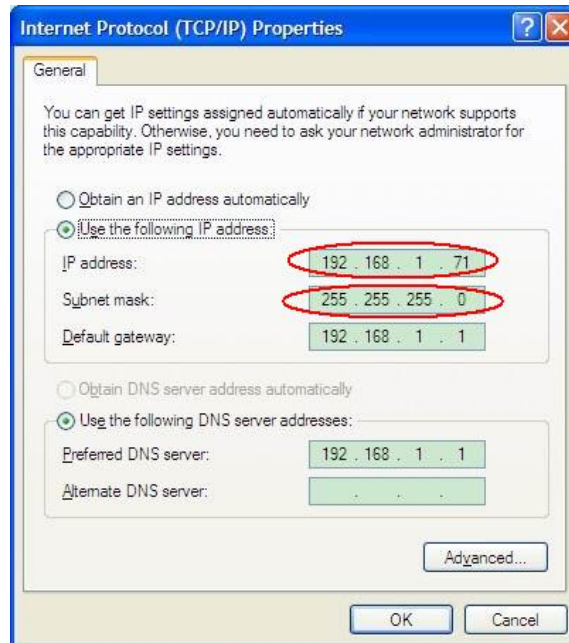

Figure 5-2 Set the network parameters of the computer

- (3) **Set the network parameters of the Oscilloscope Software.** Run the software on the computer; choose the "Ports-settings" of the "Communications" menu item. Set "Connect using" to LAN. About the IP, the first three bytes is same as the IP in the step (2), the last byte should be different. Here, we set it to 192.168.1.72. The range of the port value is 0 - 4000, but the port which under 2000 is always used, so it is suggested to set it to the value above 2000. Here, we set it to 3000.

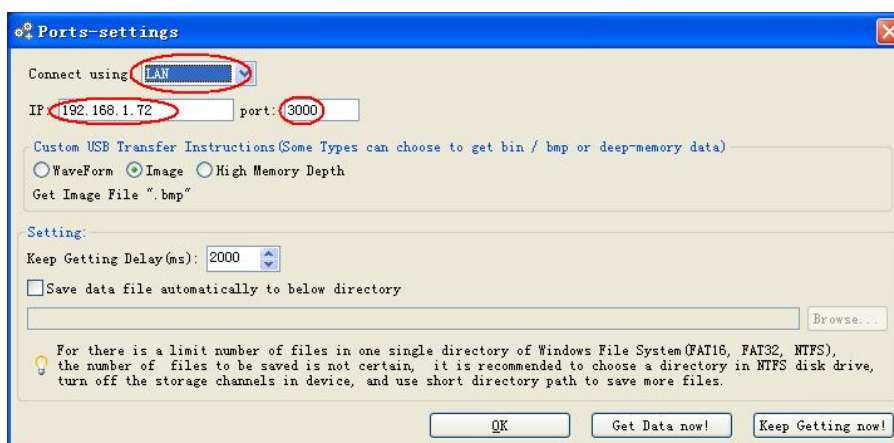

Figure 5-3 Set the network parameters of the Oscilloscope Software

- (4) **Set the network parameters of the oscilloscope.** In the oscilloscope, push the **Utility** button. Select **Function** in the bottom menu. Select **LAN Set** in the left menu. In the bottom menu, set the **Type** item as **LAN**, and select **Set**. In the right menu, set **IP** and **Port** to the same value as the "Ports-settings" in the software in step (3). Select **Save set** in the bottom menu, it prompts "Reset to update the config". After resetting the oscilloscope, if you can get data normally in the oscilloscope software, the connection is successful.

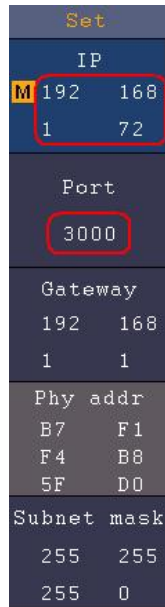

Figure 5-4 Set the network parameters of the oscilloscope

## Connect through a router

- (1) **Connection.** Use a LAN cable to connect the oscilloscope with a router, the LAN port of the oscilloscope is in the right side panel; the computer should be connected to the router too.
- (2) **Set the network parameters of the computer.** Since the oscilloscope can not support obtaining an IP address automatically, you should assign a static IP address. The Default gateway and Subnet mask should be set according to the router. Here we set the IP address to 192.168.1.71, Subnet mask is 255.255.255.0, Default gateway is 192.168.1.1.

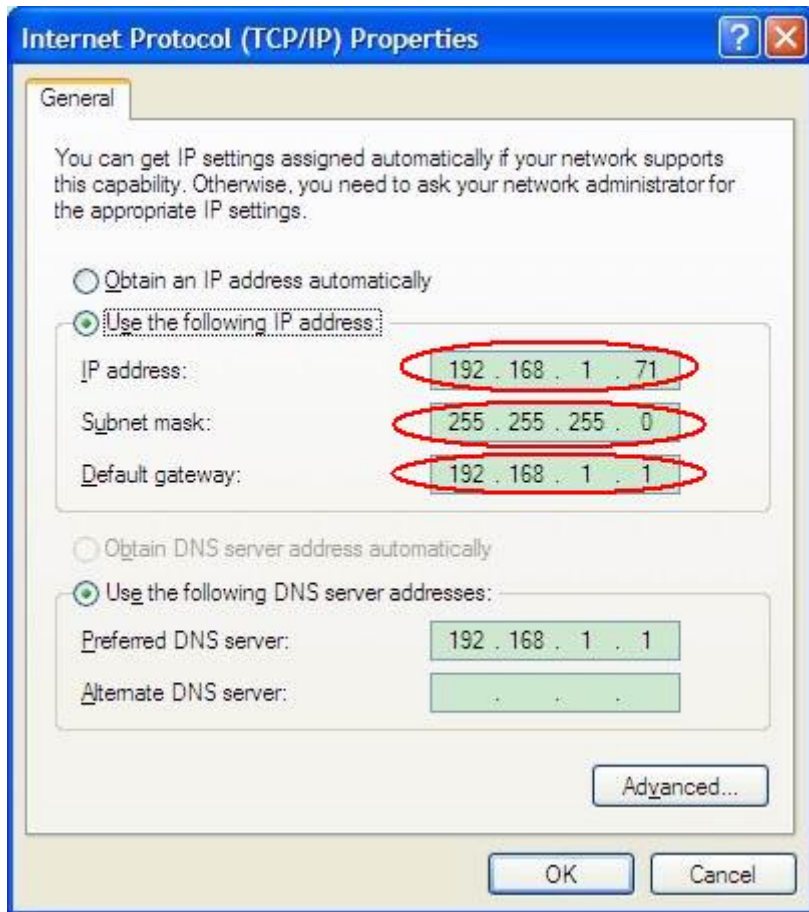

Figure 5-5 Set the network parameters of the computer

- (3) **Set the network parameters of the Oscilloscope Software.** Run the software on the computer; choose the "Ports-settings" of the "Communications" menu item. Set "Connect using" to LAN. About the IP, the first three bytes is same as the IP in the step (2), the last byte should be different. Here, we set it to 192.168.1.72. The range of the port value is 0 - 4000, but the port which under 2000 is always used, so it is suggested to set it to the value above 2000. Here, we set it to 3000.

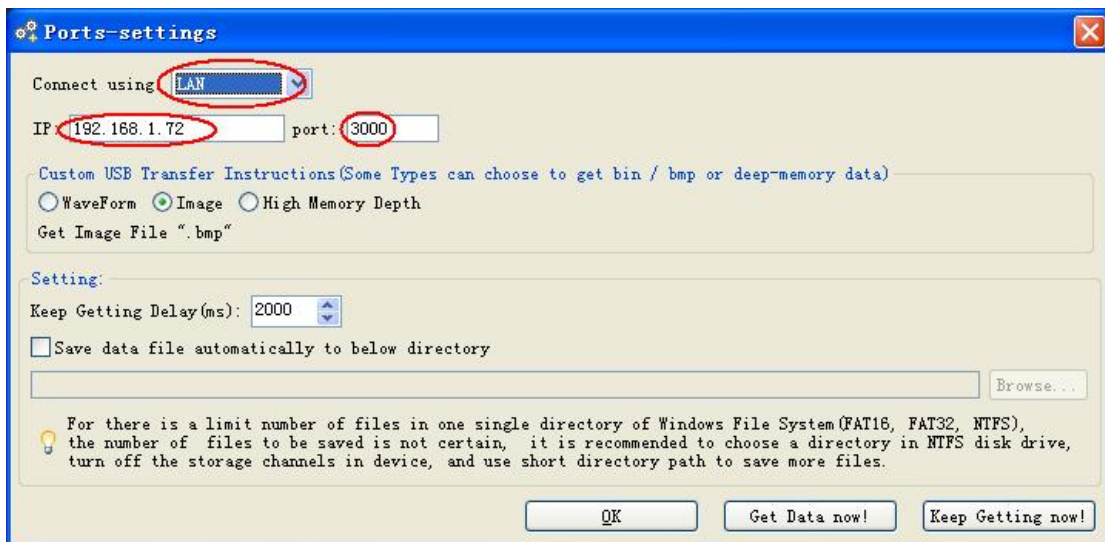

Figure 5-6 Set the network parameters of the Oscilloscope Software

- (4) **Set the network parameters of the oscilloscope.** In the oscilloscope, push the **Utility**

button. Select **Function** in the bottom menu. Select **LAN Set** in the left menu. In the bottom menu, set the **Type** item as **LAN**, and select **Set**. In the right menu, set **IP** and **Port** to the same value as the "Ports-settings" in the software in step (3). The Netgate and Net mask should be set according to the router. Select **Save set** in the bottom menu, it prompts "Reset to update the config". After resetting the oscilloscope, if you can get data normally in the oscilloscope software, the connection is successful.

Set	
IP	
M 192	168
1	72
Port	
3000	
Gateway	
192	168
1	1
Phy addr	
B7	F1
F4	B8
5F	D0
Subnet mask	
255	255
255	0

Figure 5-7 Set the network parameters of the oscilloscope



## 6. Demonstration

### Example 1: Measurement a Simple Signal

The purpose of this example is to display an unknown signal in the circuit, and measure the frequency and peak-to-peak voltage of the signal.

#### 1. Carry out the following operation steps for the rapid display of this signal:

- (1) Set the probe menu attenuation coefficient as **10X** and that of the switch in the probe switch as **10X** (see "*How to Set the Probe Attenuation Coefficient*" on P12).
- (2) Connect the probe of **Channel 1** to the measured point of the circuit.
- (3) Push the **Autoset** button.

The oscilloscope will implement the **Autoset** to make the waveform optimized, based on which, you can further regulate the vertical and horizontal divisions till the waveform meets your requirement.

#### 2. Perform Automatic Measurement

The oscilloscope can measure most of the displayed signals automatically. To measure the period, the frequency of the CH1, following the steps below:

- (1) Push the **Measure** button to show the Measure menu.
- (2) Select **Add** in the bottom menu.
- (3) In the right menu, select **CH1** in the **Source** menu item.
- (4) In the left Type menu, turn the **M** knob to select **Period**.
- (5) In the right menu, select **Add**. The period type is added.
- (6) In the left Type menu, turn the **M** knob to select **Frequency**.
- (7) In the right menu, select **Add**. The frequency type is added.

The measured value will be displayed at the bottom left of the screen automatically (see *Figure 6-1*).

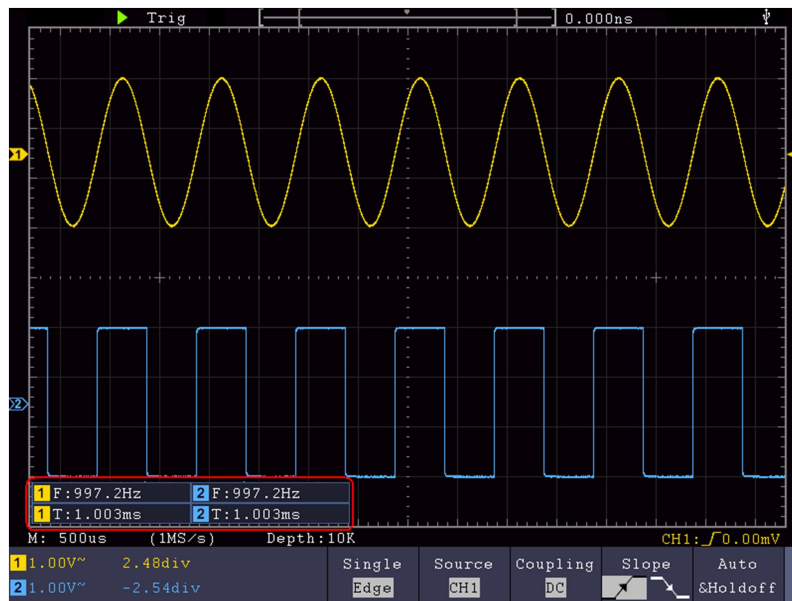

Figure 6- 1 Measure period and frequency value for a given signal

## Example 2: Gain of a Amplifier in a Metering Circuit

The purpose of this example is to work out the Gain of an Amplifier in a Metering Circuit. First we use Oscilloscope to measure the amplitude of input signal and output signal from the circuit, then to work out the Gain by using given formulas.

Set the probe menu attenuation coefficient as **10X** and that of the switch in the probe as **10X** (see "*How to Set the Probe Attenuation Coefficient*" on P12).

Connect the oscilloscope CH1 channel with the circuit signal input end and the CH2 channel to the output end.

### Operation Steps:

- (1) Push the **Autoset** button and the oscilloscope will automatically adjust the waveforms of the two channels into the proper display state.
- (2) Push the **Measure** button to show the Measure menu.
- (3) Select **Add** in the bottom menu.
- (4) In the right menu, select **CH1** in the **Source** menu item.
- (5) In the left Type menu, turn the **M** knob to select **PK-PK**.
- (6) In the right menu, select **Add**. The peak-to-peak type of CH1 is added.
- (7) In the right menu, select **CH2** in the **Source** menu item.
- (8) In the left Type menu, turn the **M** knob to select **PK-PK**.
- (9) In the right menu, select **Add**. The peak-to-peak type of CH2 is added.
- (10) Read the peak-to-peak voltages of Channel 1 and Channel 2 from the bottom left of the screen (see *Figure 6- 2*).
- (11) Calculate the amplifier gain with the following formulas.

Gain = Output Signal / Input signal

Gain (db) = 20×log (gain)

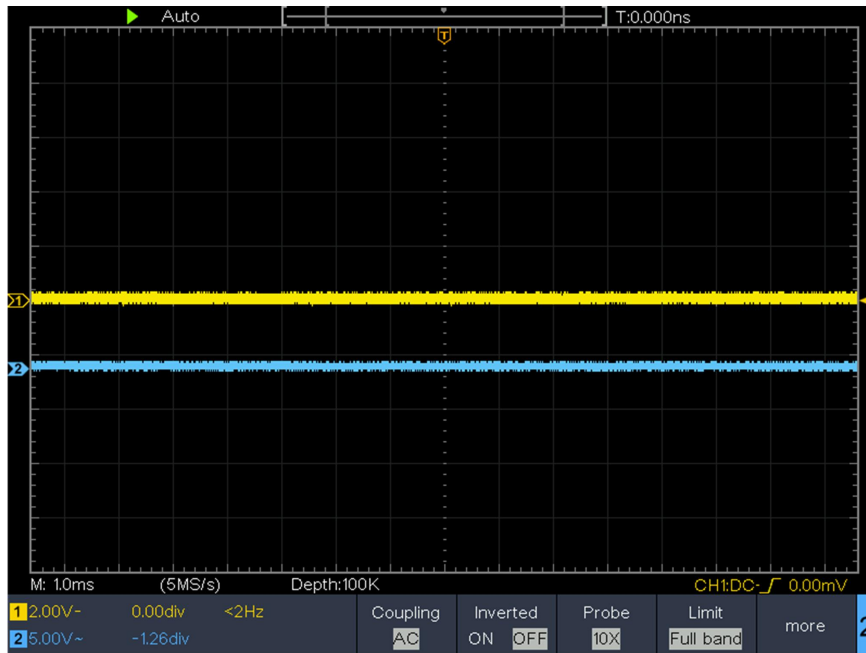



Figure 6- 2 Waveform of Gain Measurement

### Example 3: Capturing a Single Signal

It's quite easy to use Digital Oscilloscope to capture non-periodic signal, such as a pulse and burr etc. But the common problem is how to set up a trigger if you have no knowledge of the signal? For example, if the pulse is the logic signal of a TTL level, the trigger level should be set to 2 volts and the trigger edge be set as the rising edge trigger. With various functions supported by our Oscilloscope, user can solve this problem by taking an easy approach. First to run your test using auto trigger to find out the closest trigger level and trigger type, this helps user to make few small adjustments to achieve a proper trigger level and mode. Here is how we achieve this.

**The operation steps are as follows:**

- (1) Set the probe menu attenuation coefficient to 10X and that of the switch in the probe to 10X (see "*How to Set the Probe Attenuation Coefficient*" on P12).
- (2) Adjust the **Vertical Scale** and **Horizontal Scale** knobs to set up a proper vertical and horizontal ranges for the signal to be observed.
- (3) Push the **Acquire** button to display the Acquire menu.
- (4) Select **Acqu Mode** in the bottom menu. Select **Peak Detect** in the right menu.
- (5) Push the **Trigger Menu** button to display the Trigger menu.
- (6) Select the first menu item in the bottom menu. Select **Single** in the right menu.
- (7) In the left menu, select **Edge** as the mode.

- (8) Select **Source** in the bottom menu. Select **CH1** in the right menu.
- (9) Select **Coupling** in the bottom menu. Select **DC** in the right menu.
- (10) In the bottom menu, select **Slope** as  (rising).
- (11) Turn the **Trigger Level** knob and adjust the trigger level to the roughly 50% of the signal to be measured.
- (12) Check the Trigger State Indicator on the top of the screen, if it is not Ready, push down the **Run/Stop** button and start acquiring, wait for trigger to happen. If a signal reaches to the set trigger level, one sampling will be made and then displayed in the screen. By using this approach, a random pulse can be captured easily. For instance, if we want to find a burst burr of high amplitude, set the trigger level to a slightly higher value of the average signal level, push the **Run/Stop** button and wait a trigger. Once there is a burr occurring, the instrument will trigger automatically and record the waveform during the period around the trigger time. By turning the **Horizontal Position** knob in the horizontal control area in the panel, you can change the horizontal triggering position to obtain the negative delay, making an easy observation of the waveform before the burr occurs (see *Figure 6-3*).

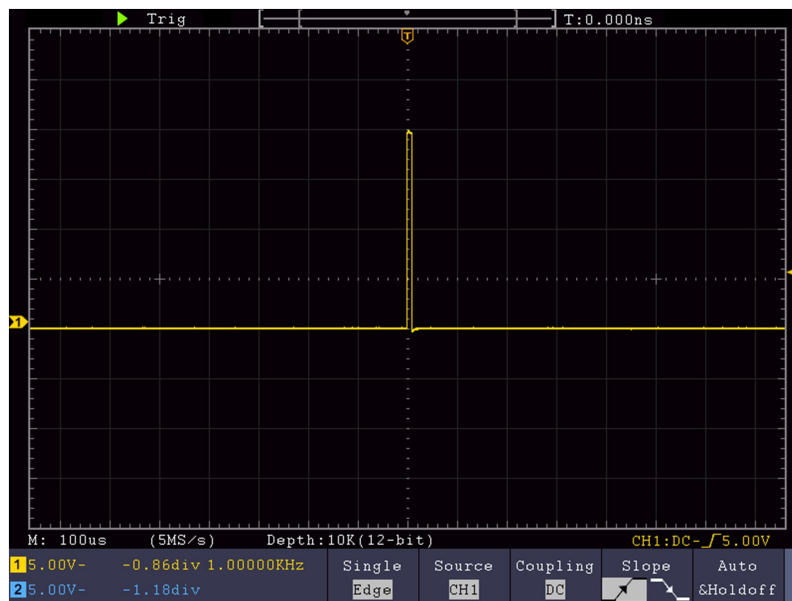

Figure 6-3 Capturing a Single Signal

## Example 4: Analyze the Details of a Signal

Noise is very common inside most of the electronic signal. To find out what's inside the noise and reduce the level of noise is very important function our oscilloscope is capable to offer.

### Noise Analysis

The level of noise sometime indicates a failure of electronic circuit. The Peak Detect

functions acts an important role to help you to find out the details of these noise. Here is how we do it:

- (1) Push the **Acquire** button to display the Acquire menu.
- (2) Select **Acqu Mode** in the bottom menu.
- (3) Select **Peak Detect** in the right menu.

The signal displayed on the screen containing some noise, by turning on Peak Detect function and changing time base to slow down the incoming signal, any peaks or burr would be detected by the function (see *Figure 6-4*).

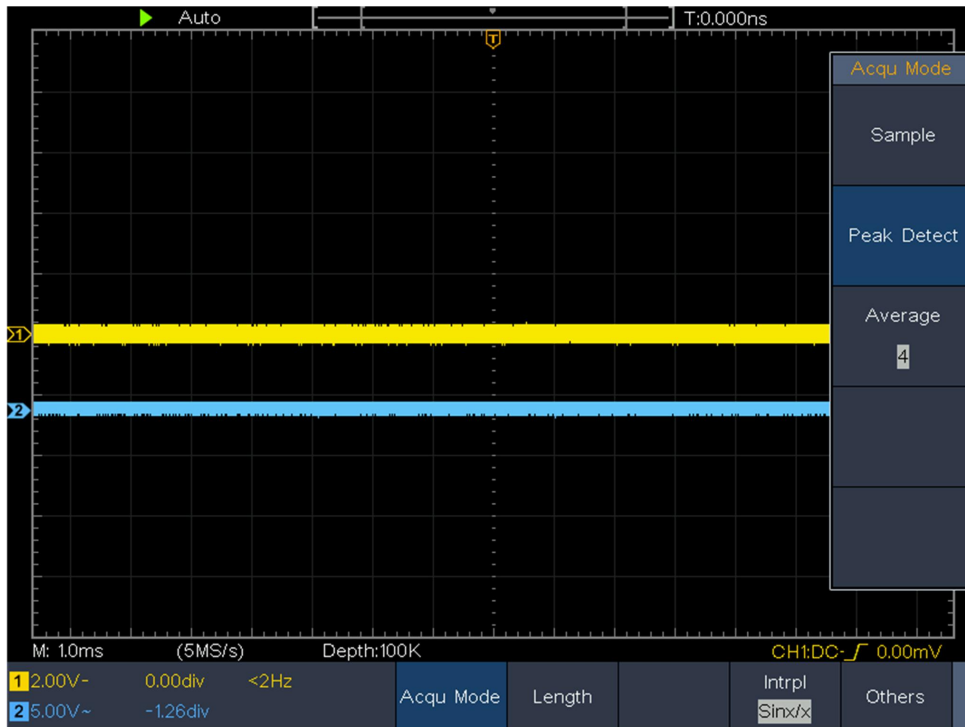

Figure 6-4 Signal with Noises

### Separate Noises from the Signal

When focusing on signal itself, the important thing is to reduce the noise level as lower as possible, this would enable user to have more details about the signal. The Average function offered by our Oscilloscope can help you to achieve this.

Here are the steps for how to enable Average function.

- (1) Push the **Acquire** button to display the Acquire menu.
- (2) Select **Acqu Mode** in the bottom menu.
- (3) Select **Average** in the right menu, turn the **M** knob and observe the waveform obtained from averaging the waveforms of different average number.

User would see a much reduced random noise level and make it easy to see more details of the signal itself. After applying Average, user can easily identify the burrs on the rising and falling edges of some part of the signal (see *Figure 6-5*).

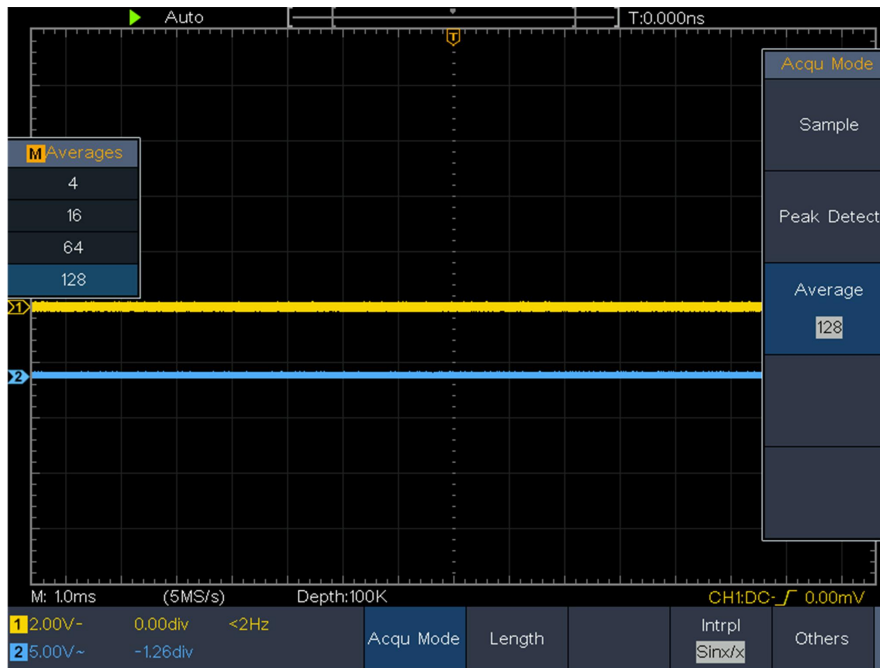

Figure 6- 5 Reduce Noise level by using Average function

## Example 5: Application of X-Y Function

### Examine the Phase Difference between Signals of two Channels

Example: Test the phase change of the signal after it passes through a circuit network.

X-Y mode is a very useful when examining the Phase shift of two related signals. This example takes you step by step to check out the phase change of the signal after it passes a specified circuit. Input signal to the circuit and output signal from circuit are used as source signals.

For the examination of the input and output of the circuit in the form of X-Y coordinate graph, please operate according to the following steps:

- (1) Set the probe menu attenuation coefficient for **10X** and that of the switch in the probe for **10X** (see "*How to Set the Probe Attenuation Coefficient*" on P12).
- (2) Connect the probe of channel 1 to the input of the network and that of Channel 2 to the output of the network.
- (3) Push the **Autoset** button, with the oscilloscope turning on the signals of the two channels and displaying them in the screen.
- (4) Turn the **Vertical Scale** knob, making the amplitudes of two signals equal in the rough.
- (5) Push the **Display** button and recall the Display menu.
- (6) Select **XY Mode** in the bottom menu. Select **Enable** as **ON** in the right menu. The oscilloscope will display the input and terminal characteristics of the network in the Lissajous graph form.

- (7) Turn the **Vertical Scale** and **Vertical Position** knobs, optimizing the waveform.
- (8) With the elliptical oscillogram method adopted, observe and calculate the phase difference (see *Figure 6-6*).

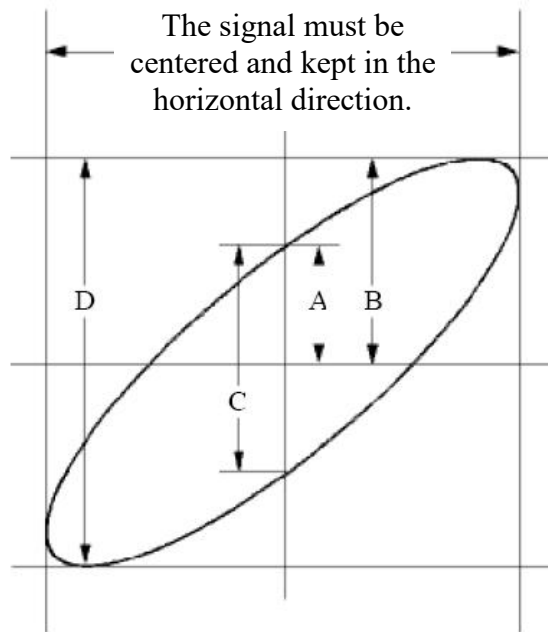

Figure 6-6 Lissajous Graph

Based on the expression  $\sin(\mathbf{q}) = \mathbf{A/B}$  or  $\mathbf{C/D}$ , thereinto,  $\mathbf{q}$  is the phase difference angle, and the definitions of A, B, C, and D are shown as the graph above. As a result, the phase difference angle can be obtained, namely,  $\mathbf{q} = \pm \arcsin(\mathbf{A/B})$  or  $\pm \arcsin(\mathbf{C/D})$ . If the principal axis of the ellipse is in the I and III quadrants, the determined phase difference angle should be in the I and IV quadrants, that is, in the range of  $(0 - \pi/2)$  or  $(3\pi/2 - 2\pi)$ . If the principal axis of the ellipse is in the II and IV quadrants, the determined phase difference angle is in the II and III quadrants, that is, within the range of  $(\pi/2 - \pi)$  or  $(\pi - 3\pi/2)$ .

## Example 6: Video Signal Trigger

Observe the video circuit of a television, apply the video trigger and obtain the stable video output signal display.

### Video Field Trigger

For the trigger in the video field, carry out operations according to the following steps:

- (1) Push the **Trigger Menu** button to display the trigger menu.
- (2) Select the first menu item in the bottom menu. Select **Single** in the right menu.
- (3) In the left menu, select **Video** as the mode.
- (4) Select **Source** in the bottom menu. Select **CH1** in the right menu.

## 6.Demonstration

- (5) Select **Modu** in the bottom menu. Select **NTSC** in the right menu.
- (6) Select **Sync** in the bottom menu. Select **Field** in the right menu.
- (7) Turn the **Vertical Scale**, **Vertical Position** and **Horizontal Scale** knobs to obtain a proper waveform display (see *Figure 6-7*).

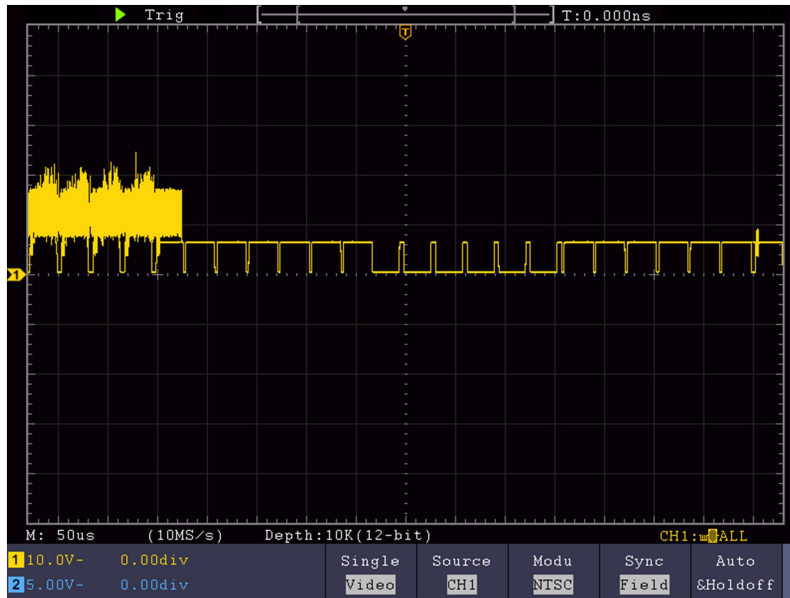

Figure 6-7 Waveform Captured from Video Field Trigger



## 7. Troubleshooting

### 1. Oscilloscope is powered on but no Display.

- Check whether the power connection is connected properly.
- Check whether the fuse which is beside the AC power input jack is blew (the cover can be pried open with a straight screwdriver).
- Restart the instrument after completing the checks above.
- If the problem persists, please contact us and we will be under your service.

### 2. After acquiring the signal, the waveform of the signal is not displayed in the screen.

- Check whether the probe is properly connected to the signal connecting wire.
- Check whether the signal connecting wire is correctly connected to the BNC (namely, the channel connector).
- Check whether the probe is properly connected with the object to be measured.
- Check whether there is any signal generated from the object to be measured (the trouble can be shot by the connection of the channel from which there is a signal generated with the channel in fault).
- Make the signal acquisition operation again.

### 3. The measured voltage amplitude value is 10 times or 1/10 of the actual value.

Look at the attenuation coefficient for the input channel and the attenuation ration of the probe, to make sure they are match (see "*How to Set the Probe Attenuation Coefficient*" on P12).

### 4. There is a waveform displayed, but it is not stable.

- Check whether the **Source** item in the **TRIG MODE** menu is in conformity with the signal channel used in the practical application.
- Check on the trigger **Type** item: The common signal chooses the **Edge** trigger mode for **Type** and the video signal the **Video**. If Alternate trigger is selected, both of the channel 1 and channel 2 trigger levels should be adjusted to the proper position. Only if a proper trigger mode is applied, the waveform can be displayed steadily.
- Try to change the trigger coupling into the high frequency suppress and the low frequency suppress to smooth the high frequency or low frequency noise triggered by the interference. (Only for the models that have this function.)

### 5. No Display Responses to the Push-down of Run/Stop.

Check whether Normal or Single is chosen for Polarity in the TRIG MODE menu and the trigger level exceeds the waveform range.

If it is, make the trigger level is centered in the screen or set the trigger mode as Auto. In addition, with the **Autoset** button pressed, the setting above can be completed automatically.

### 6. The displaying of waveform seems getting slow after increasing AVERAGE value in Acqu Mode (see "*How to Implement Sampling Setup*" on P53 ), or a longer duration is set in the Persist in Display (see "*Persist*" on P55).

It's normal as the Oscilloscope is working hard on many more data points.

## 8. Technical Specifications

Unless otherwise specified, the technical specifications applied are for XDS2000 dual-channel series only, and Probes attenuation set as 10X. Only if the oscilloscope fulfills the following two conditions at first, these specification standards can be reached.

- This instrument should run for at least 30 minutes continuously under the specified operating temperature.
- If change of the operating temperature is up to or exceeds 5°C, do a "Self-calibration" procedure (see "*How to Implement Self-calibration*" on P13).

All specification standards can be fulfilled, except one(s) marked with the word "Typical".

Performance Characteristics		Instruction		
Bandwidth	XDS2102	100 MHz		
	XDS2102A	100 MHz		
	XDS2202	200 MHz		
Vertical Resolution (A/D)	XDS2102A	12 bits		
	XDS2102	8 bits		
	XDS2202	8 bits		
Channel	2 + 1 (External)			
Waveform Refresh Rate	XDS2102A	55,000 wfms/s		
	XDS2102	75,000 wfms/s		
	XDS2202	75,000 wfms/s		
Acquisition	Mode	Normal, Peak detect, Averaging		
	Max sample rate (real time)	XDS2102A	Dual CH	500 MS/s
			Single CH	8 bits mode
	XDS2102	1 GS/s		
XDS2202	1 GS/s			
Input	Input coupling	DC, AC, Ground		
	Input impedance	1 MΩ±2%, in parallel with 15 pF±5 pF		
	Input coupling	0.001X - 1000X, step by 1 – 2 - 5		
	Max input voltage	1MΩ: ≤300 Vrms		
	Bandwidth limit	20 MHz, full bandwidth		
	Channel –channel isolation	50Hz: 100 : 1 10MHz: 40 : 1		
	Time delay between channel(typical)	150ps		
Horizontal System	Sampling rate range	XDS2102A	Dual CH	0.05 S/s~500 MS/s

9.Appendix

Performance Characteristics		Instruction			
		Single CH	8 bits mode	0.05 S/s - 1 GS/s	
			12 bits mode	0.05 S/s - 500 MS/s	
	XDS2102 XDS2202		0.05 S/s - 1 GS/s		
Interpolation	(Sinx)/x, x				
Max Record length	XDS2102A	20M.			
	XDS2102 XDS2202	40M; 80M (Optional)			
Scanning speed (S/div)	2ns/div - 1000s/div, step by 1 - 2 - 5				
Sampling rate / relay time accuracy	XDS2102A	± 1 ppm (Typical, Ta = +25°C)			
	XDS2102 XDS2202	± 25 ppm (Typical, Ta = +25°C)			
Interval(ΔT) accuracy (DC - 100MHz)	Single: ± (1 interval time+1 ppm×reading+0.6 ns); Average>16: ± (1 interval time +1 ppm×reading+0.4 ns)				
Vertical system	Sensitivity	1 mV/div~10 V/div			
	Displacement	XDS2102A	±2 V (1 mV/div – 50 mV/div); ±20 V (100 mV/div – 1 V/div); ±200 V (2 V/div – 10 V/div)		
		XDS2102 XDS2202	±2 V (1 mV/div – 100mV/div); ± 200V (200 mV/div – 10 V/div)		
	Analog bandwidth	XDS2102 XDS2102A	100 MHz		
		XDS2202	200 MHz		
	Single bandwidth	Full bandwidth			
	Low Frequency	≥10 Hz (at input, AC coupling, -3 dB)			
	Rise time (at input, Typical)	XDS2102 XDS2102A	≤ 3.5 ns		
		XDS2202	≤ 1.75 ns		
	DC gain accuracy	XDS2102A	1 mV	3%	
2 mV			2%		
≥ 5 mV			1.5%		
XDS2102 XDS2202		1 mV	4%		
		≥ 2 mV	3%		

## 8. Technical Specifications

Performance Characteristics		Instruction
	DC accuracy (average)	Delta Volts between any two averages of $\geq 16$ waveforms acquired with the same scope setup and ambient conditions ( $\Delta V$ ): $\pm(3\% \text{ rdg} + 0.05 \text{ div})$
	Waveform inverted ON/OFF	
<b>Measurement</b>	Cursor	$\Delta V$ , $\Delta T$ , $\Delta T \& \Delta V$ between cursors, auto cursor
	Automatic	Max, Min, PK-PK, Top, Base, Amplitude, Mean, RMS, Cycle RMS, Cursor RMS, Overshoot, Preshoot, Period, Frequency, Rise Time, Fall Time, +PulseWidth, -PulseWidth, +Duty Cycle, -Duty Cycle, Screen Duty, FRR, FRF, FFR, FFF, LRR, LRF, LFR, LFF, Delay A→B $\overline{\text{P}}$ , Delay A→B $\overline{\text{N}}$ , Phase, +PulseCount, -PulseCount, RiseEdgeCnt, FallEdgeCnt, Area, Cycle Area.
	Waveform Math	+, -, *, /, FFT, FFTrms, Intg, Diff, Sqrt, User Defined Function, digital filter (low pass, high pass, band pass, band reject)
	Decoding Type	RS232/UART, I2C, SPI, CAN
	Waveform storage	50 waveforms
	Lissajous figure	Bandwidth Phase difference
<b>Communication port</b>	Standard	USB, USB Host (USB storage) ; Trig Out(P/F); LAN port
	Optional	VGA port and AV port
<b>Counter</b>	Support	

### Trigger

Performance Characteristics		Instruction	
Trigger level range	XDS2102A	Internal	$\pm 5$ div from the screen center
		EXT	$\pm 2$ V
		EXT/5	$\pm 10$ V
	XDS2102 XDS2202	Internal	$\pm 5$ div from the screen center
		EXT	$\pm 1.5$ V
		EXT/5	$\pm 7.5$ V
Trigger level	Internal	$\pm 0.3$ div	
Accuracy (typical)	EXT	$\pm (10 \text{ mV} + 6\% \text{ of Set Value})$	
	EXT/5	$\pm (50 \text{ mV} + 6\% \text{ of Set Value})$	
Trigger displacement	According to Record length and time base		

## 8. Technical Specifications

Trigger Holdoff range	100 ns – 10 s	
50% level setting (typical)	Input signal frequency $\geq$ 50 Hz	
Edge trigger	slope	Rising, Falling
Video Trigger	Modulation	Support standard NTSC, PAL and SECAM broadcast systems
	Line number range	1-525 (NTSC) and 1-625 (PAL/SECAM)
Pulse trigger	Trigger condition	Positive pulse: >, <, = Negative pulse: >, <, =
	Pulse Width range	30 ns to 10 s
Slope Trigger	Trigger condition	Positive pulse: >, <, = Negative pulse: >, <, =
	Time setting	30 ns to 10 s
Runt Trigger	Polarity	Positive, Negative
	Pulse Width Condition	>, =, <
	Pulse Width Range	30 ns to 10 s
Windows Trigger	Polarity	Positive, Negative
	Trigger Position	Enter, Exit, Time
	Windows Time	30 ns to 10 s
Timeout Trigger	Edge Type	Rising, Falling
	Idle Time	30 ns to 10 s
Nth Edge Trigger	Edge Type	Rising, Falling
	Idle Time	30 ns to 10 s
	Edge Number	1 to 128
Logic Trigger	Logic Mode	AND, OR, XNOR, XOR
	Input Mode	H, L, X, Rising, Falling
	Output Mode	Goes True, Goes False, Is True >, Is True <, Is True =
RS232/UART Trigger	Polarity	Normal, Inverted
	Trigger Condition	Start, Error, Check Error, Data
	Baud Rate	Common, Custom
	Data Bits	5 bit, 6 bit, 7 bit, 8 bit
I2C Trigger	Trigger Condition	Start, Restart, Stop, ACK Lost, Address, Data, Addr/Data
	Address Bits	7 bit, 8 bit, 10 bit
	Address Range	0 to 127, 0 to 255, 0 to 1023
	Byte Length	1 to 5
SPI Trigger	Trigger Condition	Timeout
	Timeout Value	30 ns to 10 s
	Data Bits	4 bit to 32 bit

## 8. Technical Specifications

	Data Line Setting	H, L, X
CAN Trigger	Signal Type	CAN_H, CAN_L, TX, RX
	Trigger Condition	Start of Frame, Type of Frame, Identifier, Data, ID & Data, End of Frame, Missing Ack, Bit Stuffing Error
	Baud Rate	Common, Custom
	Sample Point	5% to 95%
	Frame Type	Data, Remote, Error, Overload

## General Technical Specifications

### Display

Display Type	8" Colored LCD (Liquid Crystal Display)
Display Resolution	800 (Horizontal) × 600 (Vertical) Pixels
Display Colors	65536 colors, TFT screen

### Output of the Probe Compensator

Output Voltage (Typical)	About 5 V, with the Peak-to-Peak voltage $\geq 1 \text{ M}\Omega$ .
Frequency (Typical)	Square wave of 1 KHz

### Power

Mains Voltage	100V - 240 VACRMS, 50/60 Hz, CAT II
Power Consumption	< 15 W
Fuse	2 A, T class, 250 V

### Environment

Temperature	Working temperature: 0 °C - 40 °C Storage temperature: -20 °C - 60 °C
Relative Humidity	$\leq 90\%$
Height	Operating: 3,000 m Non-operating: 15,000 m
Cooling Method	Fan cooling

### Mechanical Specifications

Dimension	340 mm × 177 mm × 90 mm (L*H*W)
Weight	Approx. 2.6 kg (without accessories)

### Interval Period of Adjustment:

One year is recommended for the calibration interval period.

## 9. Appendix

### Appendix A: Enclosure

(The accessories subject to final delivery.)

#### Standard Accessories:



**Power Cord**



**CD Rom**



**Quick Guide**



**USB Cable**



**Probe**



**Probe Adjust**

#### Options:



**Soft Bag**

### Appendix B: General Care and Cleaning

#### General Care

Do not store or leave the instrument where the liquid crystal display will be exposed to direct sunlight for long periods of time.

**Caution:** To avoid any damage to the instrument or probe, do not exposed it to any sprays, liquids, or solvents.

#### Cleaning

Inspect the instrument and probes as often as operating conditions require.

To clean the instrument exterior, perform the following steps:

1. Wipe the dust from the instrument and probe surface with a soft cloth. Do not make any scuffing on the transparent LCD protection screen when clean the LCD screen.



2. Disconnect power before cleaning your Oscilloscope. Clean the instrument with a wet soft cloth not dripping water. It is recommended to scrub with soft detergent or fresh water. To avoid damage to the instrument or probe, do not use any corrosive chemical cleaning agent.
- 



**Warning:** Before power on again for operation, it is required to confirm that the instrument has already been dried completely, avoiding any electrical short circuit or bodily injury resulting from the moisture.

---