



SDS1000 Series
Digital Storage Oscilloscope
User Manual

For product support, visit: www.owon.com.hk/download

※: The illustrations, interface, icons and characters in the user manual may be slightly different from the actual product. Please refer to the actual product.

Dec. 2023 edition V1.2.1

Copyright © LILLIPUT Company. All rights reserved.

The LILLIPUT's products are under the protection of the patent rights, including ones which have already obtained the patent rights and those which are applying for. The information in this manual will replace all that in the materials published originally.

The information in this manual was correct at the time of printing. However, LILLIPUT will continue to improve products and reserves the rights to change specification at any time without notice.

owon[®] is the registered trademark of the LILLIPUT Company.

Fujian LILLIPUT Optoelectronics Technology Co., Ltd.

No. 19, Heming Road

Lantian Industrial Zone, Zhangzhou 363005 P.R. China

Tel: +86-596-2130430

Fax: +86-596-2109272

Web: www.owon.com.cn

E-mail: info@owon.com.cn

General Warranty

We warrant that the product will be free from defects in materials and workmanship for a period of 3 years from the date of purchase of the product by the original purchaser from the our company. The warranty period for accessories such as probes is 12 months. This warranty only applies to the original purchaser and is not transferable to a third party.

If the product proves defective during the warranty period, we will either repair the defective product without charge for parts and labour, or will provide a replacement in exchange for the defective product. Parts, modules and replacement products used by our company for warranty work may be new or reconditioned like new. All replaced parts, modules and products become the property of our company.

To obtain service under this warranty, the customer must notify our company of the defect before the expiration of the warranty period. Customer shall be responsible for packaging and shipping the defective product to designated service centre, a copy of the customer's proof of purchase is also required.

This warranty shall not apply to any defect, failure or damage caused by improper use or improper or inadequate maintenance and care. We shall not be obligated to furnish service under this warranty a) to repair damage resulting from attempts by personnel other than our company representatives to install, repair or service the product; b) to repair damage resulting from improper use or connection to incompatible equipment; c) to repair any damage or malfunction caused by the use of non our supplies; or d) to service a product that has been modified or integrated with other products when the effect of such modification or integration increases the time or difficulty of servicing the product.

Please contact the nearest Sales and Service Offices for services.

Excepting the after-sales services provided in this summary or the applicable warranty statements, we will not offer any guarantee for maintenance definitely declared or hinted, including but not limited to the implied guarantee for marketability and special-purpose acceptability. We should not take any responsibilities for any indirect, special or consequent damages.

Table of Contents

1. General Safety Requirements	1
2. Safety Terms and Symbols	2
3. Quick Start	4
Introduction to the Structure of the Oscilloscope	4
Front Panel	4
Rear Panel	5
Control Area	6
User Interface Introduction	7
How to Implement the General Inspection	8
How to Implement the Function Inspection	9
How to Implement the Probe Compensation	10
How to Set the Probe Attenuation Coefficient	11
How to Use the Probe Safely	12
How to Implement Self-calibration	12
Introduction to the Vertical System	12
Introduction to the Horizontal System	14
Introduction to the Trigger System	14
4. Advanced User Guidebook	16
How to Set the Vertical System	17
Use Mathematical Manipulation Function	18
The Waveform Calculation	18
Using FFT function	19
Use Vertical Position and Scale Knobs	22
How to Set the Horizontal System	23
Zoom the Waveform	23
How to Set the Trigger System	24
Single Trigger	25
Alternate Trigger (Trigger mode: Edge)	26
How to Operate the Function Menu	27
How to Set the Sampling/Display	27
How to Save and Recall a Waveform	28
How to Implement the Auxiliary System Function Setting	35
How to Update your Instrument Firmware	37
How to Measure Automatically	38
How to Measure with Cursors	42
How to Use Executive Buttons	45
5. Communication with PC	47

6. Demonstration	47
Example 1: Measurement a Simple Signal	47
Example 2: Gain of a Amplifier in a Metering Circuit	48
Example 3: Capturing a Single Signal	49
Example 4: Analyze the Details of a Signal	51
Example 5: Application of X-Y Function	53
Example 6: Video Signal Trigger	54
7. Troubleshooting	56
8. Technical Specifications	57
General Technical Specifications	59
9. Appendix	61
Appendix A: Enclosure	61
Appendix B: General Care and Cleaning	61

1. General Safety Requirements

Before use, please read the following safety precautions to avoid any possible bodily injury and to prevent this product or any other connected products from damage. To avoid any contingent danger, ensure this product is only used within the ranges specified.

Only a qualified person should perform internal maintenance.

To avoid Fire or Personal Injury:

- **Use Proper Power Cord.** Use only the power cord supplied with the product and certified to use in your country.
- **Connect or Disconnect Correctly.** When the probe or test lead is connected to a voltage source, please do not connect and disconnect the probe or test lead.
- **Product Grounded.** This instrument is grounded through the power cord grounding conductor. To avoid electric shock, the grounding conductor must be grounded. The product must be grounded properly before any connection with its input or output terminals.

When the instrument is powered by AC, do not measure AC power sources directly otherwise it will cause a short circuit. This is because the testing ground and power cord ground conductor are connected.

- **Check all Terminal Ratings.** To avoid fire or shock hazard, check all ratings and markings on this product. Refer to the user manual for more information about ratings before connecting to the instrument.
- **Do not operate without covers.** Do not operate the instrument with covers or panels removed.
- **Use the Proper Fuse.** Use only the specified type and rating fuse for this instrument.
- **Avoid exposed circuit.** Be careful when working on exposed circuitry to avoid risk of electric shock or other injury.
- **Do not operate if any damage.** If you suspect damage to the instrument, have it inspected by qualified service personnel before further use.
- **Use your Oscilloscope in a well-ventilated area.** Make sure the instrument installed with proper ventilation.
- **Do not operate in damp conditions.**
- **Do not operate in an explosive atmosphere.**
- **Keep product surfaces clean and dry.**

2. Safety Terms and Symbols

Safety Terms

Terms in this manual (The following terms may appear in this manual):

 **Warning:** Warning indicates conditions or practices that could result in injury or loss of life.

 **Caution:** Caution indicates the conditions or practices that could result in damage to this product or other property.

Terms on the product. The following terms may appear on this product:

Danger: Indicates an immediate hazard or injury possibility.

Warning: Indicates a possible hazard or injury.

Caution: Indicates potential damage to the instrument or other property.

Safety Symbols

Symbols on the product. The following symbol may appear on the product:

 Hazardous Voltage

 Refer to Manual

 Protective Earth Terminal

 Chassis Ground

 Test Ground

To avoid body damage and prevent product and connected equipment damage, carefully read the following safety information before using the test tool. This product can only be used in the specified applications.



Warning:

The two channels of the oscilloscope are not electrically isolated. The channels should adopt a common ground during measuring. To prevent short circuits, the 2 probe grounds must not be connected to 2 different non-isolated DC levels.

The diagram of the oscilloscope ground wire connection:

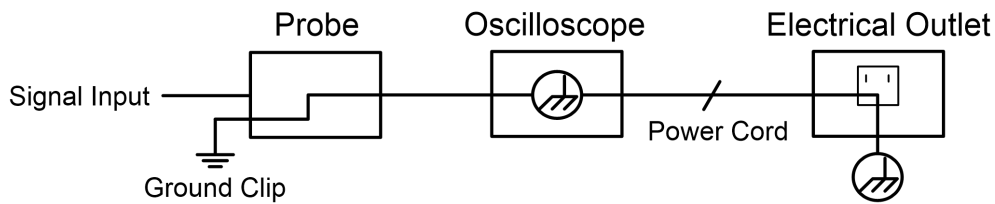

It is not allowed to measure AC power when the AC powered oscilloscope is connected to the AC-powered PC through the ports.



Warning:

To avoid fire or electrical shock, when the oscilloscope input signal connected is more than 42V peak (30Vrms) or on circuits of more than 4800VA, please take note of below items:

- **Only use accessory insulated voltage probes and test lead.**
- **Check the accessories such as probe before use and replace it if there are any damages.**
- **Remove probes, test leads and other accessories immediately after use.**
- **Remove USB cable which connects oscilloscope and computer.**
- **Do not apply input voltages above the rating of the instrument because the probe tip voltage will directly transmit to the oscilloscope. Use with caution when the probe is set as 1:1.**
- **Do not use exposed metal BNC or banana plug connectors.**
- **Do not insert metal objects into connectors.**

3. Quick Start

Introduction to the Structure of the Oscilloscope

This chapter makes a simple description of the operation and function of the front panel of the oscilloscope, enabling you to be familiar with the use of the oscilloscope in the shortest time.

Front Panel

The front panel has knobs and function buttons. The 5 buttons in the column on the right side of the display screen are menu selection buttons, through which, you can set the different options for the current menu. The other buttons are function buttons, through which, you can enter different function menus or obtain a specific function application directly.

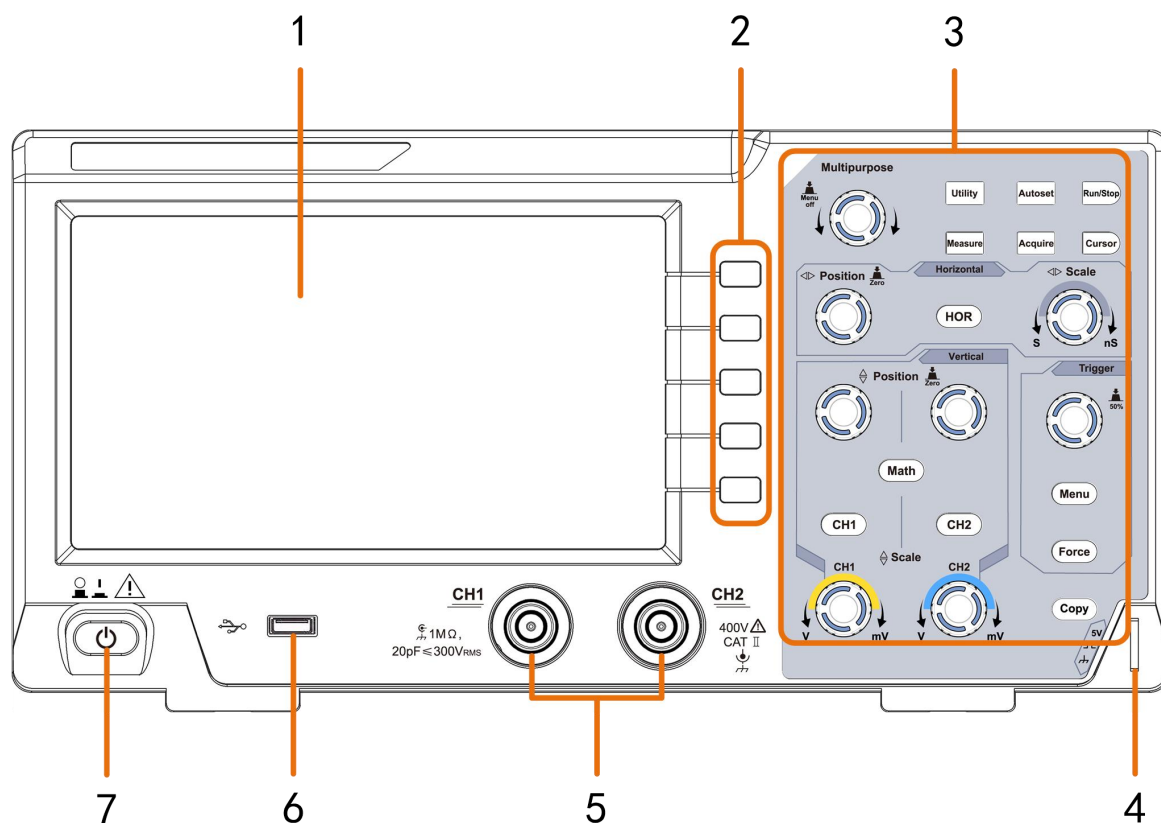

Figure 3- 1 Front panel

1. Display area.
2. Menu selection buttons: Select the right menu item.
3. Control (button and knob) area.
4. Probe Compensation: Measurement signal (5V/1kHz) output.
5. Signal Input Channel.
6. **USB Host port:** It is used to transfer data when external USB equipment connects to the oscilloscope regarded as "host device". For example: Saving the waveform to USB flash disk needs to use this port.
7. Power on/off.

Rear Panel

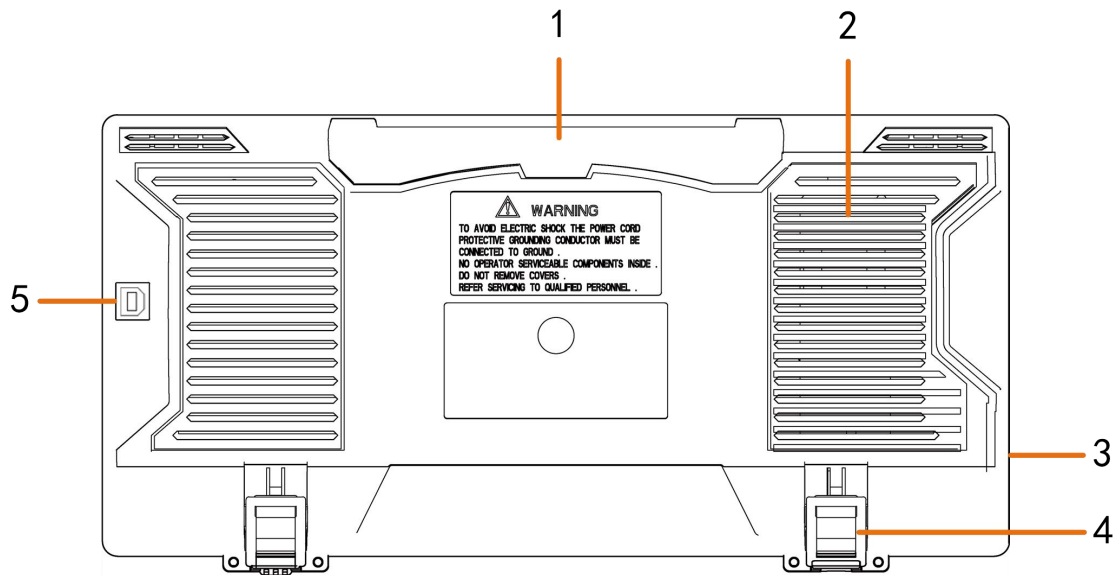

Figure 3-2 Rear Panel

1. Handle.
2. Air vents.
3. AC power input jack.
4. **Foot stool:** Adjust the tilt angle of the oscilloscope.
5. **USB Device port:** It is used to transfer data when external USB equipment connects to the oscilloscope regarded as "slave device". For example: to use this port when connect PC to the oscilloscope by USB.

Control Area

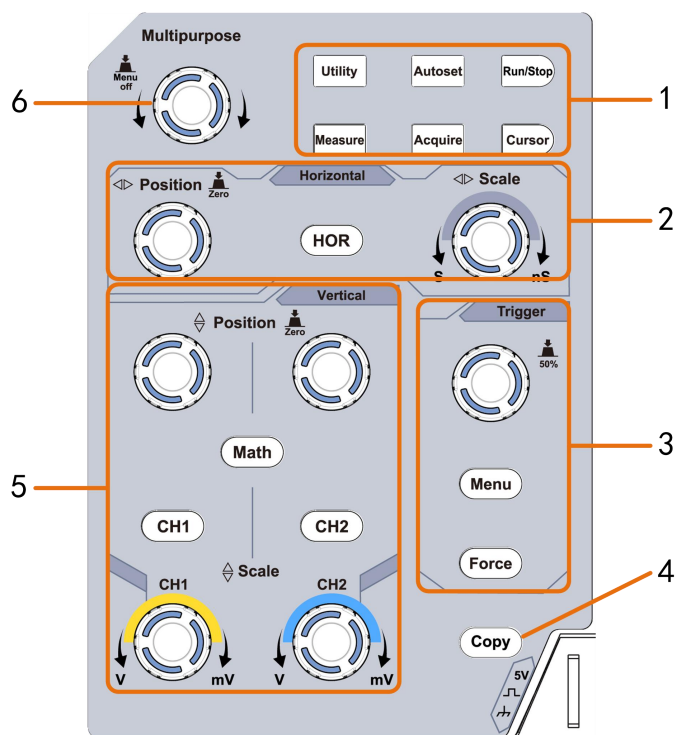

Figure 3-3 Control Area Overview

1. **Function button area:** Total 6 buttons.
2. **Horizontal control area** with 1 button and 2 knobs.
 "HOR" button refer to horizontal system setting menu, "Horizontal Position" knob control trigger position, "Horizontal Scale" control time base.
3. **Trigger control area** with 2 buttons and 1 knob.
 The Trigger Level knob is to adjust trigger voltage. Other 2 buttons refer to trigger system setting.
4. **Copy button:** This button is the shortcut for **Save** function in the **Utility** function menu. Pressing this button is equal to the **Save** option in the Save menu. The waveform, configure or the display screen could be saved according to the chosen type in the Save menu.
5. **Vertical control area** with 3 buttons and 4 knobs.
 "CH1" and "CH2 " correspond to setting menu in CH1 and CH2, "Math" button refer to math menu, the math menu consists of six kinds of operations, including CH1-CH2, CH2-CH1, CH1+CH2, CH1*CH2, CH1/CH2 and FFT. Two "Vertical Position" knob control the vertical position of CH1/CH2, and two "Scale" knob control voltage scale of CH1, CH2.
6. **M knob(Multipurpose knob):** when a **M** symbol appears in the menu, it indicates you can turn the **M** knob to select the menu or set the value. You can push it to close the menu on the left and right.

User Interface Introduction

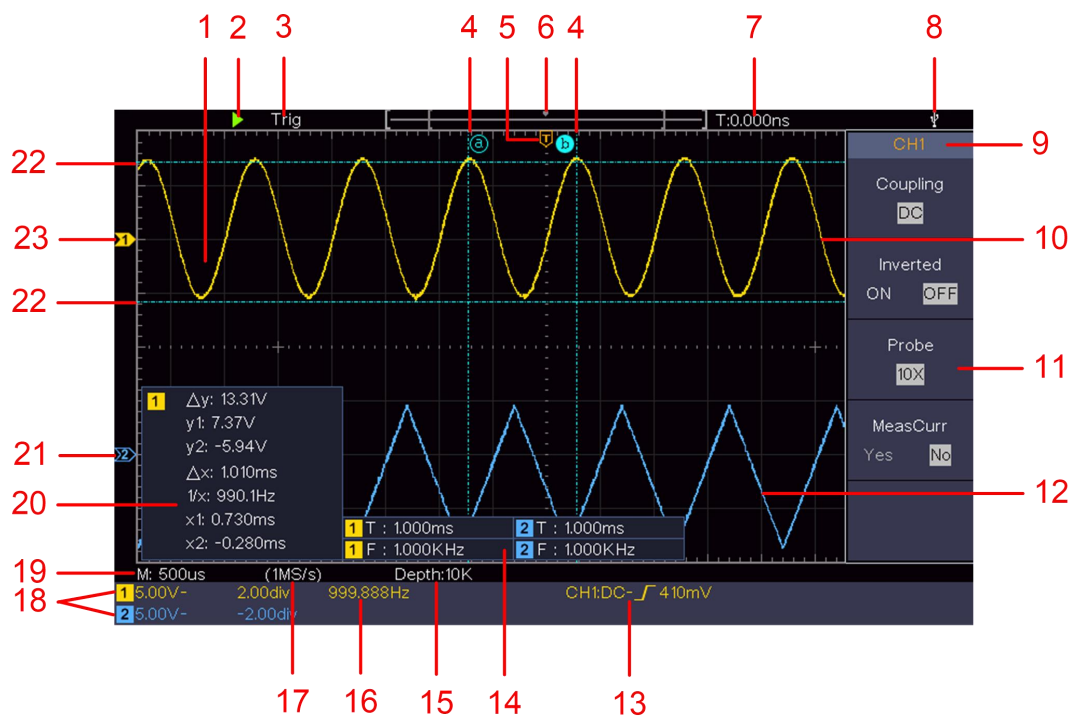





Figure 3-4 Illustrative Drawing of Display Interfaces

1. Waveform Display Area.
2. Run/Stop.
3. The state of trigger, including:
 - Auto: Automatic mode and acquire waveform without triggering.
 - Trig: Trigger detected and acquire waveform.
 - Ready: Pre-triggered data captured and ready for a trigger.
 - Scan: Capture and display the waveform continuously.
 - Stop: Data acquisition stopped.
4. The two blue dotted lines indicates the vertical position of cursor measurement.
5. The T pointer indicates the horizontal position for the trigger.
6. The pointer indicates the trigger position in the record length.
7. It shows present triggering value and displays the site of present window in internal memory.
8. It indicates that there is a USB disk connecting with the oscilloscope.
9. Channel identifier of current menu.
10. The waveform of CH1.
11. Right Menu.
12. The waveform of CH2.
13. Current trigger type:
 - \int Rising edge triggering;

-  Falling edge triggering;
-  Video line synchronous triggering;
-  Video field synchronous triggering.

The reading shows the trigger level value of the corresponding channel.

14. It indicates the measured type and value of the corresponding channel. "T" means period, "F" means frequency, "V" means the average value, "Vp" the peak-peak value, "Vr" the root-mean-square value, "Ma" the maximum amplitude value, "Mi" the minimum amplitude value, "Vt" the Voltage value of the waveform's flat top value, "Vb" the Voltage value of the waveform's flat base, "Va" the amplitude value, "Os" the overshoot value, "Ps" the Preshoot value, "RT" the rise time value, "FT" the fall time value, "PW" the +width value, "NW" the -Width value, "+D" the +Duty value, "-D" the -Duty value, "PD" the Delay A->B Φ value, "ND" the Delay A->B Ψ value, "TR" the Cycle RMS, "CR" the Cursor RMS, "WP" the Screen Duty, "RP" the Phase, "+PC" the +Pulse count, "-PC" the - Pulse count, "+E" the Rise edge count, "-E" the Fall edge count, "AR" the Area, "CA" the Cycle area.
15. The readings show the record length.
16. The frequency of the trigger signal.
17. The readings show current sample rate.
18. The readings indicate the corresponding Voltage Division and the Zero Point positions of the channels. "BW" indicates bandwidth limit.
The icon shows the coupling mode of the channel.
"—" indicates direct current coupling;
"~" indicates AC coupling;
" \equiv " indicates GND coupling.
19. The reading shows the setting of main time base.
20. It is cursor measure window, showing the absolute values and the readings of the cursors.
21. The blue pointer shows the grounding datum point (zero point position) of the waveform of the CH2 channel. If the pointer is not displayed, it means that this channel is not opened.
22. The two blue dotted lines indicate the horizontal position of cursor measurement.
23. The yellow pointer indicates the grounding datum point (zero point position) of the waveform of the CH1 channel. If the pointer is not displayed, it means that the channel is not opened.

How to Implement the General Inspection

After you get a new oscilloscope, it is recommended that you should make a check on the instrument according to the following steps:

1. Check whether there is any damage caused by transportation.

If it is found that the packaging carton or the foamed plastic protection cushion has suffered serious damage, do not throw it away first till the complete device and its accessories succeed in the electrical and mechanical property tests.

2. Check the Accessories

The supplied accessories have been already described in the "Appendix A: Enclosure" of this Manual. You can check whether there is any loss of accessories with reference to this description. If it is found that there is any accessory lost or damaged, please get in touch with the distributor of our responsible for this service or the our local offices.

3. Check the Complete Instrument

If it is found that there is damage to the appearance of the instrument, or the instrument can not work normally, or fails in the performance test, please get in touch with the our distributor responsible for this business or the our local offices. If there is damage to the instrument caused by the transportation, please keep the package. With the transportation department or the our distributor responsible for this business informed about it, a repairing or replacement of the instrument will be arranged by the us.

How to Implement the Function Inspection

Make a fast function check to verify the normal operation of the instrument, according to the following steps:

1. **Connect the power cord to a power source. Press the  button on the bottom left of the instrument.**

The instrument carries out all self-check items and shows the Boot Logo. Push the **Utility** button, select **Function** in the right menu. Select **Adjust** in the left menu, select **Default** in the right menu. The default attenuation coefficient set value of the probe in the menu is 10X.

2. **Set the Switch in the Oscilloscope Probe as 10X and Connect the Oscilloscope with CH1 Channel.**

Align the slot in the probe with the plug in the CH1 connector BNC, and then tighten the probe with rotating it to the right side.

Connect the probe tip and the ground clamp to the connector of the probe compensator.

3. **Push the Autoset Button on the front panel.**

The square wave of 1 KHz frequency and 5V peak-peak value will be displayed in several seconds (see *Figure 3-5*).

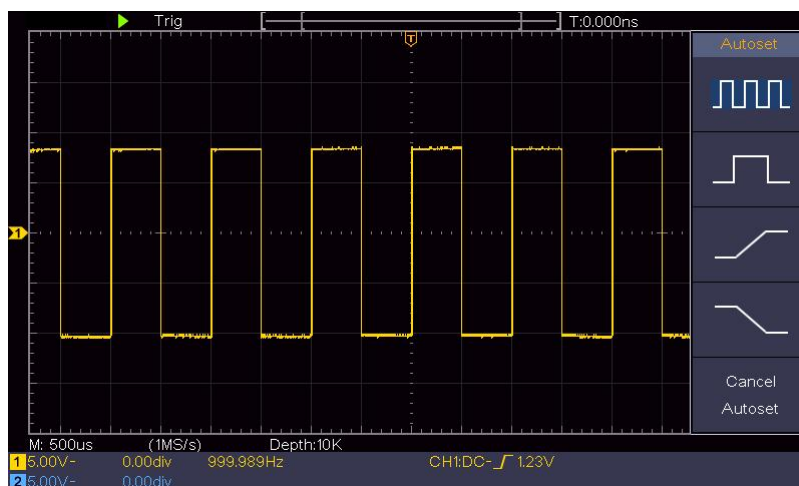

Figure 3-5 Auto set

Check CH2 by repeating Step 2 and Step 3.

How to Implement the Probe Compensation

When connect the probe with any input channel for the first time, make this adjustment to match the probe with the input channel. The probe which is not compensated or presents a compensation deviation will result in the measuring error or mistake. For adjusting the probe compensation, please carry out the following steps:

1. Set the attenuation coefficient of the probe in the menu as 10X and that of the switch in the probe as 10X (see "*How to Set the Probe Attenuation Coefficient*" on P11), and connect the probe with the CH1 channel. If a probe hook tip is used, ensure that it keeps in close touch with the probe. Connect the probe tip with the signal connector of the probe compensator and connect the reference wire clamp with the ground wire connector of the probe connector, and then push the **Autoset** button on the front panel.
2. Check the displayed waveforms and regulate the probe till a correct compensation is achieved (see *Figure 3-6* and *Figure 3-7*).

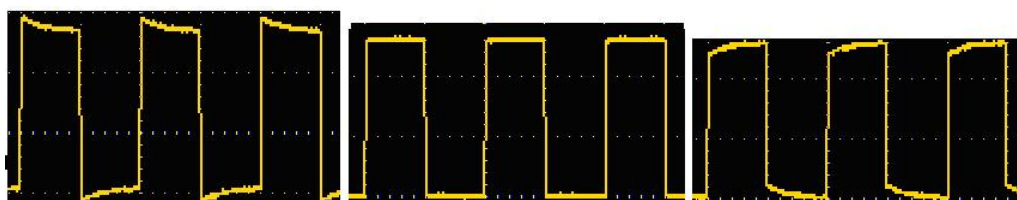

Overcompensated

Compensated correctly

Under compensated

Figure 3-6 Displayed Waveforms of the Probe Compensation

3. Repeat the steps mentioned if needed.

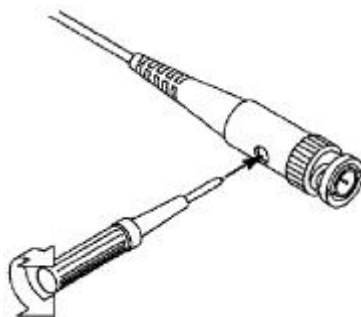

Figure 3-7 Adjust Probe

How to Set the Probe Attenuation Coefficient

The probe has several attenuation coefficients, which will influence the vertical scale factor of the oscilloscope.

To change or check the probe attenuation coefficient in the menu of oscilloscope:

- (1) Push the function menu button of the used channels (**CH1** or **CH2** button).
- (2) Select **Probe** in the right menu; turn the **M** knob to select the proper value in the left menu corresponding to the probe.

This setting will be valid all the time before it is changed again.



Caution:

The default attenuation coefficient of the probe on the instrument is preset to 10X.

Make sure that the set value of the attenuation switch in the probe is the same as the menu selection of the probe attenuation coefficient in the oscilloscope.

The set values of the probe switch are 1X and 10X (see *Figure 3-8*).

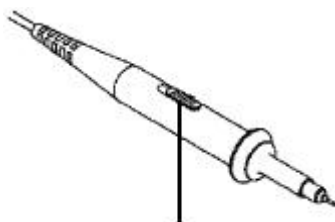

Figure 3-8 Attenuation Switch



Caution:

When the attenuation switch is set to 1X, the probe will limit the bandwidth of the oscilloscope in 5MHz. To use the full bandwidth of the oscilloscope, the switch must be set to 10X.

How to Use the Probe Safely

The safety guard ring around the probe body protects your finger against any electric shock, shown as *Figure 3-9*.

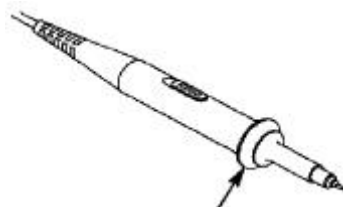

Figure 3-9 Finger Guard



Warning:

To avoid electric shock, always keep your finger behind the safety guard ring of the probe during the operation.

To protect you from suffering from the electric shock, do not touch any metal part of the probe tip when it is connected to the power supply.

Before making any measurements, always connect the probe to the instrument and connect the ground terminal to the earth.

How to Implement Self-calibration

The self-calibration application can make the oscilloscope reach the optimum condition rapidly to obtain the most accurate measurement value. You can carry out this application program at any time. This program must be executed whenever the change of ambient temperature is 5°C or over.

Before performing a self-calibration, disconnect all probes or wires from the input connector. Push the **Utility** button, select **Function** in the right menu, select **Adjust.** in the left menu, select **Self Cal** in the right menu; run the program after everything is ready.

Introduction to the Vertical System

As shown in *Figure 3-10*, there are a few of buttons and knobs in **Vertical Controls**. The following practices will gradually direct you to be familiar with the using of the vertical setting.

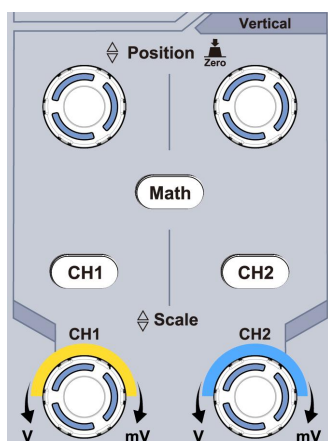

Figure 3- 10 Vertical Control Zone

1. Use the **Vertical Position** knob to show the signal in the center of the waveform window. The **Vertical Position** knob functions the regulating of the vertical display position of the signal. Thus, when the **Vertical Position** knob is rotated, the pointer of the earth datum point of the channel is directed to move up and down following the waveform.

Measuring Skill

If the channel is under the DC coupling mode, you can rapidly measure the DC component of the signal through the observation of the difference between the waveform and the signal ground.

If the channel is under the AC mode, the DC component would be filtered out. This mode helps you display the AC component of the signal with a higher sensitivity.

Vertical offset back to 0 shortcut key

Turn the **Vertical Position** knob to change the vertical display position of channel and push the position knob to set the vertical display position back to 0 as a shortcut key, this is especially helpful when the trace position is far out of the screen and want it to get back to the screen center immediately.

2. Change the Vertical Setting and Observe the Consequent State Information Change.

With the information displayed in the status bar at the bottom of the waveform window, you can determine any changes in the channel vertical scale factor.

- Turn the **Vertical Scale** knob and change the "Vertical Scale Factor (Voltage Division)", it can be found that the scale factor of the channel corresponding to the status bar has been changed accordingly.
- Push buttons of **CH1**, **CH2** and **Math**, the operation menu, symbols, waveforms and scale factor status information of the corresponding channel will be displayed in the screen.

Introduction to the Horizontal System

Shown as *Figure 3-11*, there are a button and two knobs in the **Horizontal Controls**. The following practices will gradually direct you to be familiar with the setting of horizontal time base.

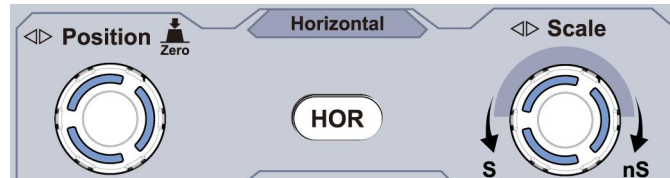

Figure 3- 11 Horizontal Control Zone

1. Turn the **Horizontal Scale** knob to change the horizontal time base setting and observe the consequent status information change. Turn the **Horizontal Scale** knob to change the horizontal time base, and it can be found that the **Horizontal Time Base** display in the status bar changes accordingly.
2. Use the **Horizontal Position** knob to adjust the horizontal position of the signal in the waveform window. The **Horizontal Position** knob is used to control the triggering displacement of the signal or for other special applications. If it is applied to triggering the displacement, it can be observed that the waveform moves horizontally with the knob when you rotate the **Horizontal Position** knob.

Triggering displacement back to 0 shortcut key

Turn the **Horizontal Position** knob to change the horizontal position of channel and push the **Horizontal Position** knob to set the triggering displacement back to 0 as a shortcut key.

3. Push the **Horizontal HOR** button to switch between the normal mode and the wave zoom mode.

Introduction to the Trigger System

As shown in *Figure 3-12*, there are one knob and three buttons make up **Trigger Controls**. The following practices will direct you to be familiar with the setting of the trigger system gradually.

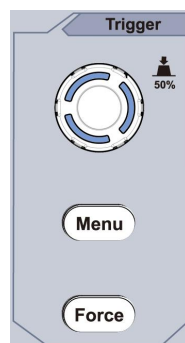

Figure 3- 12 Trigger Control Zone

3.Quick Start

1. Push the **Trigger Menu** button and call out the trigger menu. With the operations of the menu selection buttons, the trigger setting can be changed.
2. Use the **Trigger Level** knob to change the trigger level setting.
By turning the **Trigger Level** knob, the trigger indicator in the screen will move up and down. With the movement of the trigger indicator, it can be observed that the trigger level value displayed in the screen changes accordingly.
Note: Turning the **Trigger Level** knob can change trigger level value and it is also the hotkey to set trigger level as the vertical mid point values of the amplitude of the trigger signal.
3. Push the **Force** button to force a trigger signal, which is mainly applied to the "Normal" and "Single" trigger modes.

4. Advanced User Guidebook

This chapter will deal with the following topics mainly:

- **How to Set the Vertical System**
- **How to Set the Horizontal System**
- **How to Set the Trigger System**
- **How to Set the Sampling/Display**
- **How to Save and Recall Waveform**
- **How to Implement the Auxiliary System Function Setting**
- **How to Update your Instrument Firmware**
- **How to Measure Automatically**
- **How to Measure with Cursors**
- **How to Use Executive Buttons**

It is recommended that you read this chapter carefully to get acquainted the various measurement functions and other operation methods of the oscilloscope.

How to Set the Vertical System

The **VERTICAL CONTROLS** includes three menu buttons such as **CH1**, **CH2** and **Math**, and four knobs such as **Vertical Position**, **Vertical Scale** for each channel.

Setting of CH1 and CH2

Each channel has an independent vertical menu and each item is set respectively based on the channel.

To turn waveforms on or off (channel, math)

Pushing the **CH1**, **CH2**, or **Math** buttons have the following effect:

- If the waveform is off, the waveform is turned on and its menu is displayed.
- If the waveform is on and its menu is not displayed, its menu will be displayed.
- If the waveform is on and its menu is displayed, the waveform is turned off and its menu goes away.

The description of the Channel Menu is shown as the following list:

Function Menu	Setting	Description
Coupling	DC AC Ground	Pass both AC and DC components of the input signal. Block the DC component of the input signal. Disconnect the input signal.
Inverted	ON OFF	Display inverted waveform. Display original waveform.
Probe	1X 10X 100X 1000X	Match this to the probe attenuation factor to have an accurate reading of vertical scale.
MeasCurr	Yes No	If you are measuring current by probing the voltage drop across a resistor, choose Yes .
A/V or mA/V	V/A or mV/A	Turn the M knob to set the Amps/Volts ratio. The range is 100 mA/V - 1 KA/V. Amps/Volts ratio = 1/Resistor value Volts/Amp ratio is automatically calculated.
Limit (only for SDS1102/ SDS1202)	Full band 20M	Get full bandwidth. Limit the channel bandwidth to 20MHz to reduce display noise.

1. To set channel coupling

Taking the Channel 1 for example, the measured signal is a square wave signal containing the direct current bias. The operation steps are shown as below:

- (1) Push the **CH1** button to show the CH1 SETUP menu.

- (2) In the right menu, select **Coupling** as **DC**. Both DC and AC components of the signal are passed.
- (3) In the right menu, select **Coupling** as **AC**. The direct current component of the signal is blocked.

2. To invert a waveform

Waveform inverted: the displayed signal is turned 180 degrees against the phase of the earth potential.

Taking the Channel 1 for example, the operation steps are shown as follows:

- (1) Push the **CH1** button to show the CH1 SETUP menu.
- (2) In the right menu, select **Inverted** as **ON**, the waveform is inverted. Push again to switch to **OFF**, the waveform goes back to its original one.

3. To adjust the probe attenuation

For correct measurements, the attenuation coefficient settings in the operating menu of the Channel should always match what is on the probe (see "*How to Set the Probe Attenuation Coefficient*" on P11). If the attenuation coefficient of the probe is 1:1, the menu setting of the input channel should be set to **1X**.

Take the Channel 1 as an example, the attenuation coefficient of the probe is 10:1, the operation steps are shown as follows:

- (1) Push the **CH1** button to show the CH1 SETUP menu.
- (2) In the right menu, select **Probe**. In the left menu, turn the **M** knob to set it as **10X**.

4. To measure current by probing the voltage drop across a resistor

Take the Channel 1 as an example, if you are measuring current by probing the voltage drop across a 1Ω resistor, the operation steps are shown as follows:

- (1) Push the **CH1** button to show CH1 SETUP menu.
- (2) In the right menu, set **MeasCurr** as **Yes**, the A/V ratio menu will appear below. Select it; turn the **M** knob to set the Amps/Volts ratio. Amps/Volts ratio = $1/\text{Resistor value}$. Here the A/V ratio should be set to 1.

Use Mathematical Manipulation Function

The **Mathematical Manipulation** function is used to show the results of the addition, multiplication, division and subtraction operations between two channels, or the FFT operation for a channel. Press the **Math** button to display the menu on the right.

The Waveform Calculation

Press the **Math** button to display the menu on the right, select **Type** as **Math**.

Function Menu	Setting	Description
Type	Math	Display the Math menu.
Factor1	CH1 CH2	Select the signal source of the factor1.
Sign	+ - * /	Select the sign of mathematical manipulation.
Factor2	CH1 CH2	Select the signal source of the factor2.
Next Page		Enter next page.
Vertical (div)		Turn the M knob to adjust the vertical position of the Math waveform.
Vertical (V/div)		Turn the M knob to adjust the voltage division of the Math waveform.
Prev Page		Enter previous page.

Taking the additive operation between Channel 1 and Channels 2 for example, the operation steps are as follows:

1. Press the **Math** button to display the math menu in the right. The pink M waveform appears on the screen.
2. In the right menu, select **Type** as **Math**.
3. In the right menu, select **Factor1** as **CH1**.
4. In the right menu, select **Sign** as **+**.
5. In the right menu, select **Factor2** as **CH2**.
6. Press **Next Page** in the right menu. Select **Vertical (div)**, the **M** symbol is in front of **div**, turn the **M** knob to adjust the vertical position of Math waveform.
7. Select **Vertical (V/div)** in the right menu, the **M** symbol is in front of the voltage, turn the **M** knob to adjust the voltage division of Math waveform.

Using FFT function

The FFT (fast Fourier transform) math function mathematically converts a time-domain waveform into its frequency components. It is very useful for analyzing the input signal on Oscilloscope. You can match these frequencies with known system frequencies, such as system clocks, oscillators, or power supplies.

FFT function in this oscilloscope transforms 2048 data points of the time-domain signal into its frequency components mathematically (the record length should be 10K or above). The final frequency contains 1024 points ranging from 0Hz to Nyquist frequency.

Press the **Math** button to display the menu on the right, select **Type** as **FFT**.

Function Menu	Setting	Description
Type	FFT	Display the FFT menu.

4. Advanced User Guidebook

Source	CH1	Select CH1 as FFT source.
	CH2	Select CH2 as FFT source.
Window	Hamming	Select window for FFT.
	Rectangle	
	Blackman	
	Hanning	
	Kaiser	
	Bartlett	
Format	Vrms	Select Vrms for Format.
	dB	Select dB for Format.
Next Page		Enter next page.
Hori (Hz)	frequency	Switch to select the horizontal position or time base of the FFT waveform, turn the M knob to adjust it.
	frequency/div	
Vertical	div	Switch to select the vertical position or voltage division of the FFT waveform, turn the M knob to adjust it.
	V or dBVrms	
Prev Page		Enter previous page.





Taking the FFT operation for example, the operation steps are as follows:

1. Press the **Math** button to display the math menu in the right.
2. In the right menu, select **Type** as **FFT**.
3. In the right menu, select **Source** as **CH1**.
4. In the right menu, select **Window**. Select the proper window type in the left menu.
5. In the right menu, select **Format** as **Vrms** or **dB**.
6. In the right menu, press **Hori (Hz)** to make the **M** symbol in front of the frequency value, turn the **M** knob to adjust the horizontal position of FFT waveform; then press to make the **M** symbol in front of the **frequency/div** below, turn the **M** knob to adjust the time base of FFT waveform.
7. Select **Vertical** in the right menu; do the same operations as above to set the vertical position and voltage division.

To select the FFT window

■ There are 6 FFT windows. Each one has trade-offs between frequency resolution and magnitude accuracy. What you want to measure and your source signal characteristics help you to determine which window to use. Use the following guidelines to select the best window.

4. Advanced User Guidebook

Type	Characteristics	Window
Hamming	<p>Better solution for magnitude than Rectangle, and good for frequency as well. It has slightly better frequency resolution than Hanning.</p> <p>Recommend to use for:</p> <ul style="list-style-type: none"> ● Sine, periodic and narrow band random noise. ● Transients or bursts where the signal levels before and after the event are significantly different. 	
Rectangle	<p>Best solution for frequency, worst for magnitude.</p> <p>Best type for measuring the frequency spectrum of nonrepetitive signals and measuring frequency components near DC.</p> <p>Recommend to use for:</p> <ul style="list-style-type: none"> ● Transients or bursts, the signal level before and after the event are nearly equal. ● Equal-amplitude sine waves with frequencies those are very close. ● Broadband random noise with a relatively slow varying spectrum. 	
Blackman	<p>Best solution for magnitude, worst for frequency.</p> <p>Recommend to use for:</p> <ul style="list-style-type: none"> ● Single frequency waveforms, to find higher order harmonics. 	
Hanning	<p>Good for magnitude, but poorer frequency resolution than Hamming.</p> <p>Recommend to use for:</p> <ul style="list-style-type: none"> ● Sine, periodic and narrow band random noise. ● Transients or bursts where the signal levels before and after the event are significantly different. 	

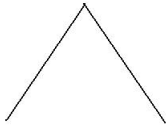
Kaiser	<p>The frequency resolution when using the Kaiser window is fair; the spectral leakage and amplitude accuracy are both good.</p> <p>The Kaiser window is best used when frequencies are very close to the same value but have widely differing amplitudes (the side lobe level and shape factor are closest to the traditional Gaussian RBW). This window is also good for random signals.</p>	
Bartlett	<p>The Bartlett window is a slightly narrower variant of the triangular window, with zero weight at both ends.</p>	

Notes for using FFT

- Use the default **dB** scale for details of multiple frequencies, even if they have very different amplitudes. Use the **Vrms** scale to compare frequencies.
- DC component or offset can cause incorrect magnitude values of FFT waveform. To minimize the DC component, choose AC Coupling on the source signal.
- To reduce random noise and aliased components in repetitive or single-shot events, set the oscilloscope acquisition mode to average.

What is Nyquist frequency?

The Nyquist frequency is the highest frequency that any real-time digitizing oscilloscope can acquire without aliasing. This frequency is half of the sample rate. Frequencies above the Nyquist frequency will be under sampled, which causes aliasing. So pay more attention to the relation between the frequency being sampled and measured.

Use Vertical Position and Scale Knobs

1. The **Vertical Position** knob is used to adjust the vertical positions of the waveforms.
The analytic resolution of this control knob changes with the vertical division.
2. The **Vertical Scale** knob is used to regulate the vertical resolution of the waveforms. The sensitivity of the vertical division steps as 1-2-5.

The vertical position and vertical resolution is displayed at the left bottom corner of the screen (see *Figure 4-1*).

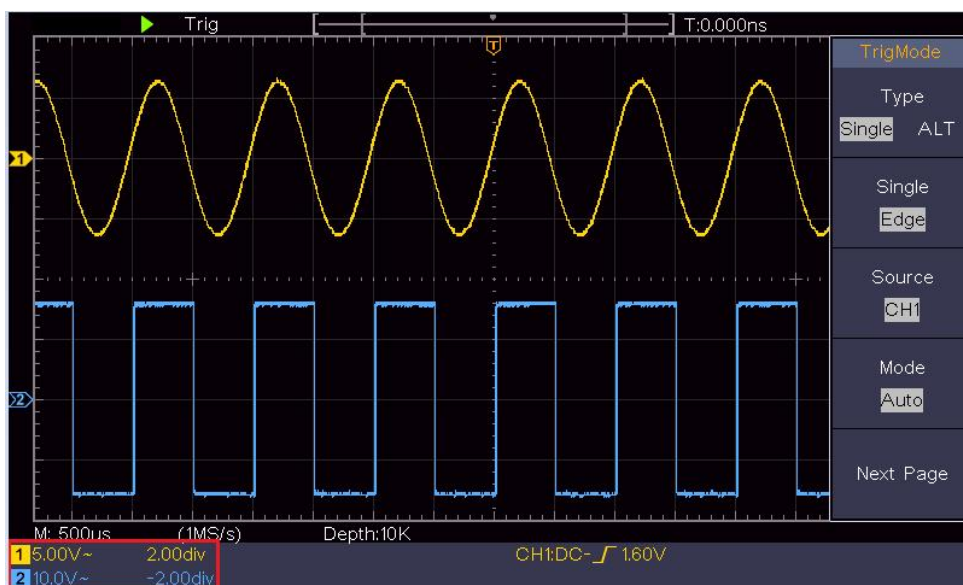

Figure 4- 1 Information about Vertical Position

How to Set the Horizontal System

The **HORIZONTAL CONTROLS** includes the **Horizontal HOR** button and such knobs as **Horizontal Position** and **Horizontal Scale**.

1. **Horizontal Position** knob: this knob is used to adjust the horizontal positions of all channels (include those obtained from the mathematical manipulation), the analytic resolution of which changes with the time base.
2. **Horizontal Scale** knob: it is used to set the horizontal scale factor for setting the main time base or the window.
3. **Horizontal HOR** button: push it to switch between the normal mode and the wave zoom mode. For more detailed operations, see the introductions below.

Zoom the Waveform

Push the **Horizontal HOR** button to enter wave zoom mode. The top half of the display shows the Main window and the bottom half displays the Zoom window. The Zoom window is a magnified portion of the Main window.

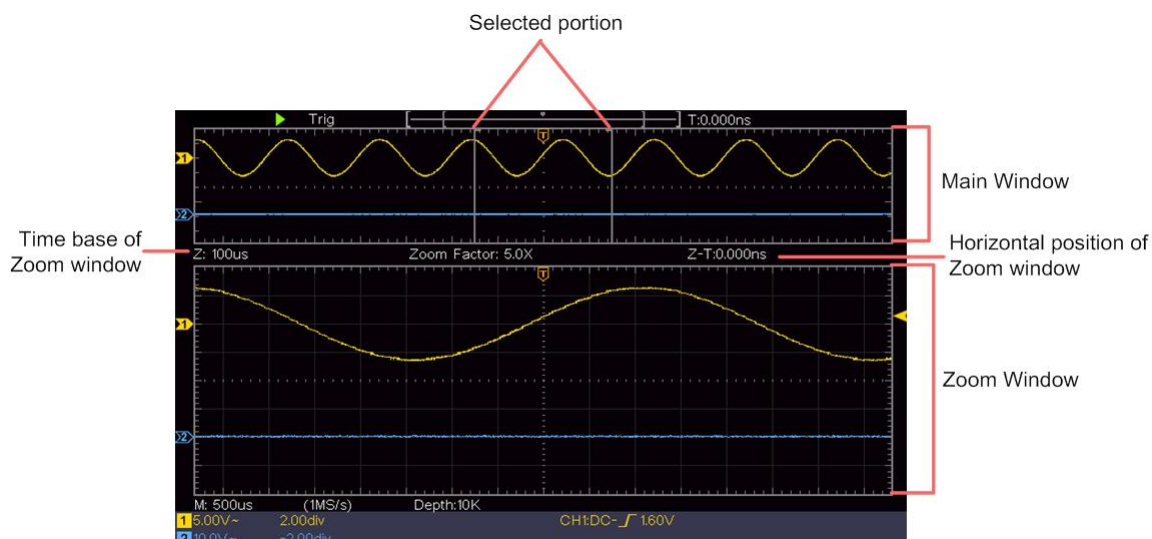

In normal mode, the **Horizontal Position** and **Horizontal Scale** knobs are used to adjust the horizontal position and time base of the Main window.

In wave zoom mode, the **Horizontal Position** and **Horizontal Scale** knobs are used to adjust the horizontal position and time base of the Zoom window.

How to Set the Trigger System

Trigger determines when DSO starts to acquire data and display waveform. Once trigger is set correctly, it can convert the unstable display to meaningful waveform.

When DSO starts to acquire data, it will collect enough data to draw waveform on left of trigger point. DSO continues to acquire data while waiting for trigger condition to occur. Once it detects a trigger it will acquire enough data continuously to draw the waveform on right of trigger point.

Trigger control area consists of 1 knob and 2 menu buttons.

Trigger Level: The knob that set the trigger level; push the knob and the level will be set as the vertical mid point values of the amplitude of the trigger signal.

Force: Force to create a trigger signal and the function is mainly used in "Normal" and "Single" mode.

Trigger Menu: The button that activates the trigger control menu.

Trigger Control

The oscilloscope provides two trigger types: single trigger, alternate trigger. Each type of trigger has different sub menus.

Single trigger: Use a trigger level to capture stable waveforms in two channels simultaneously.

Alternate trigger: Trigger on non-synchronized signals.

The **Single Trigger**, **Alternate Trigger** menus are described respectively as follows:

Single Trigger

Single trigger has two types: edge trigger, video trigger.

Edge Trigger: It occurs when the trigger input passes through a specified voltage level with the specified slope.

Video Trigger: Trigger on fields or lines for standard video signal.

The two trigger modes in Single Trigger are described respectively as follows:



1. Edge Trigger

An edge trigger occurs on trigger level value of the specified edge of input signal. Select Edge trigger mode to trigger on rising edge or falling edge.

Push the **Trigger Menu** button to display the Trigger menu on the right. Select **Type** as **Single** in the right menu. Select **Single** as **Edge** in the right menu.

In Edge Trigger mode, the trigger setting information is displayed on bottom right of the screen, for example, **CH1:DC-∫0.00mV**, indicates that trigger type is edge, trigger source is CH1, coupling is DC, and trigger level is 0.00mV.

Edge menu list:

Menu	Settings	Instruction
Type	Single	Set vertical channel trigger type as single trigger.
Single	Edge	Set vertical channel single trigger type as edge trigger.
Source	CH1 CH2	Channel 1 as trigger signal. Channel 2 as trigger signal.
Mode	Auto Normal Single	Acquire waveform even no trigger occurs Acquire waveform when trigger occurs When trigger occurs, acquire one waveform then stop
Next Page		Enter next page.
Coupling	AC DC	Block the direct current component. Allow all component pass.
Slope	 	Trigger on rising edge. Trigger on falling edge.
Holdoff		100 ns - 10 s, turn the M knob to set time interval before another trigger occur.
Holdoff Reset		Set Holdoff time as default value (100 ns).
Prev Page		Enter previous page.

Trigger Level: trigger level indicates vertical trig position of the channel, rotate trig level knob to move trigger level, during setting, a dotted line displays to show trig position, and the value of trigger level changes at the right corner, after setting, dotted line disappears.

2. Video Trigger

Choose video trigger to trigger on fields or lines of NTSC, PAL or SECAM standard video signals.

Push the **Trigger Menu** button to display the Trigger menu on the right. Select **Type** as **Single** in the right menu. Select **Single** as **Video** in the right menu.

In Video Trigger mode, the trigger setting information is displayed on bottom right of the screen, for example, **CH1:  ALL**, indicates that trigger type is Video, trigger source is CH1, and Sync type is Even.



Video Trigger menu list:

MENU	SETTING	INSTRUCTION
Type	Single	Set vertical channel trigger type as single trigger.
Single	Video	Set vertical channel single trigger type as video trigger.
Source	CH1 CH2	Select CH1 as the trigger source Select CH2 as the trigger source
Modu	NTSC PAL SECAM	Select video modulation
Next Page		Enter next page
Sync	Line Field Odd Even Line NO.	Synchronic trigger in video line Synchronic trigger in video field Synchronic trigger in video odd filed Synchronic trigger in video even field Synchronic trigger in designed video line. Press Line NO. menu item, turn the M knob to set the line number.
Prev Page		Enter previous page

Alternate Trigger (Trigger mode: Edge)

Trigger signal comes from two vertical channels when alternate trigger is on. This mode is used to observe two unrelated signals. Trigger mode is edge trigger.

Alternate trigger (Trigger Type: Edge) menu list:

Menu	Settings	Instruction
Type	ALT	Set vertical channel trigger type as alternate trigger.
Source	CH1 CH2	Channel 1 as trigger signal. Channel 2 as trigger signal.
Next Page		Enter next page.
Coupling	AC DC	Block the direct current component. Allow all component pass.
Slope	 	Trigger on rising edge. Trigger on falling edge.
Holdoff		100 ns - 10 s, turn the M knob to set time interval before another trigger occur.

Holdoff Reset		Set Holdoff time as default value (100 ns).
Prev Page		Enter previous page.

How to Operate the Function Menu

The function menu control zone includes 4 function menu buttons: **Utility**, **Measure**, **Acquire**, **Cursor**, and 2 immediate-execution buttons: **Autoset**, **Run/Stop**.

How to Set the Sampling/Display

Push the **Acquire** button, the Sampling and Display menu is shown in the right as follows:

Function Menu	Setting	Description
Acqu Mode	Sample	Normal sampling mode.
	Peak Detect	Use to capture maximal and minimal samples. Finding highest and lowest points over adjacent intervals. It is used for the detection of the jamming burr and the possibility of reducing the confusion.
	Average	It is used to reduce the random and don't-care noises, with the optional number of averages. Turn the M knob to select 4, 16, 64, 128 in the left menu.
Type	Dots	Only the sampling points are displayed.
	Vect	The space between the adjacent sampling points in the display is filled with the vector form.
Persist	OFF 1 Second 2 Seconds 5 Seconds Infinity	Set the persistence time.
XY Mode	ON OFF	Turn on/off XY display function.
Counter	ON OFF	Turn on/off counter.

Persist

When the **Persist** function is used, the persistence display effect of the picture tube oscilloscope can be simulated. The reserved original data is displayed in fade color and the new data is in bright color.

- (1) Push the **Acquire** button.
- (2) In the right menu, press **Persist** to select the persist time, including **OFF**, **1 Second**, **2 Seconds**, **5 Seconds** and **Infinity**. When the "**Infinity**" option is set for Persist Time, the measuring points will be stored till the controlling value is changed. Select **OFF**

to turn off persistence and clear the display.

XY Format

This format is only applicable to Channel 1 and Channel 2. After the XY display format is selected, Channel 1 is displayed in the horizontal axis and Channel 2 in the vertical axis; the oscilloscope is set in the un-triggered sample mode: the data are displayed as bright spots.

The operations of all control knobs are as follows:

- The **Vertical Scale** and the **Vertical Position** knobs of Channel 1 are used to set the horizontal scale and position.
- The **Vertical Scale** and the **Vertical Position** knobs of Channel 2 are used to set the vertical scale and position continuously.

The following functions can not work in the XY Format:

- Reference or digital wave form
- Cursor
- Trigger control
- FFT

Operation steps:

1. Push the **Acquire** button to show the right menu.
2. Select **XY Mode** as **ON** or **OFF** in the right menu.

Counter

It is a 6-digit single-channel counter. The counter can only measure the frequency of the triggering channel. The frequency range is from 2Hz to the full bandwidth. Only if the measured channel is in **Edge** mode of **Single** trigger type, the counter can be enabled. The counter is displayed at the bottom of the screen.



Operation steps:

1. Push **Trigger Menu** button, set the trigger type to **Single**, set the trigger mode to **Edge**, select the signal source.
2. Push the **Acquire** button to show the right menu.
3. Select **Counter** as **ON** or **OFF** in the right menu.

How to Save and Recall a Waveform

Push the **Utility** button, select **Function** in the right menu, select **Save** in the left menu. By selecting **Type** in the right menu, you can save the waveforms, configures or screen images.

When the Type is selected as **Wave**, the menu is shown as the following table:

Function Menu	Setting	Description
Function	Save	Display the save function menu.
Type	Wave	Choose the saving type as wave.
Source	CH1 CH2 Math All	Choose the waveform to be saved. (Choose All to save all the waveforms that are turned on. You can save into the current internal object address, or into USB storage as a single file.)
Object	ON OFF	The object Wave0 –Wave15 are listed in the left menu, turn the M knob to choose the object which the waveform is saved to or recall from. Recall or close the waveform stored in the current object address. When the show is ON, if the current object address has been used, the stored waveform will be shown, the address number and relevant information will be displayed at the top left of the screen; if the address is empty, it will prompt "None is saved".
Next Page		Enter next page.
Close All		Close all the waveforms stored in the object address.
File Format	BIN TXT CSV	For internal storage, only BIN can be selected. For external storage, the format can be BIN, TXT or CSV.
Storage		Save the waveform of the source to the selected address.
Storage	Internal External	Save to internal storage or USB storage. When External is selected, the file name is editable. The BIN waveform file could be open by our company waveform analysis software (on the supplied CD).
Prev Page		Enter previous page

When the Type is selected as **Configure**, the menu is shown as the following table:

Function Menu	Setting	Description
Function	Save	Display the save function menu.
Type	Configure	Choose the saving type as configure.
Configure	Setting1 Setting8	The setting address.

Save		Save the current oscilloscope configure to the internal storage.
Load		Recall the configure from the selected address.

When the Type is selected as **Image**, the menu is shown as the following table:

Function Menu	Setting	Description
Function	Save	Display the save function menu.
Type	Image	Choose the saving type as image.
Save		Save the current display screen. The file can be only stored in a USB storage, so a USB storage must be connected first. The file name is editable. The file is stored in BMP format.

Save and Recall the Waveform

The oscilloscope can store 16 waveforms, which can be displayed with the current waveform at the same time. The stored waveform called out can not be adjusted.

In order to save the waveform of CH1, CH2 and Math into the object Wave0, the operation steps should be followed:

1. Turn on CH1, CH2 and Math channels.
2. Push the **Utility** button, select **Function** in the right menu, select **Save** in the left menu. In the right menu, select **Type** as **Wave**.
3. **Saving:** In the right menu, select **Source** as **All**.
 4. In the right menu, press **Object**. Select **Wave0** as object address in the left menu.
5. In the right menu, press **Next Page**, and select **Storage** as **Internal**.
6. In the right menu, press **Save** to save the waveform.
7. **Recalling:** In the right menu, press **Prev Page**, and press **Object**, select **Wave0** in the left menu. In the right menu, select **Object** as **ON**, the waveform stored in the address will be shown, the address number and relevant information will be displayed at the top left of the screen.

In order to save the waveform of CH1 and CH2 into the USB storage as a BIN file, the operation steps should be followed:

1. Turn on CH1 and CH2 channels, turn off the Math channel.
2. Push the **Utility** button, select **Function** in the right menu, select **Save** in the left menu. In the right menu, select **Type** as **Wave**.
3. **Saving:** In the right menu, select **Source** as **All**.



4. In the right menu, press **Next Page**, and select **File Format** as **BIN**.
5. In the right menu, select **Storage** as **External**.
6. In the right menu, select **Storage**, an input keyboard used to edit the file name will pop up. The default name is current system date and time. Turn the **M** knob to choose the keys; press the **M** knob to input the chosen key. The length of file name is up to 25 characters. Select the  key in the keyboard to confirm.
7. **Recalling:** The BIN waveform file could be open by our company waveform analysis software (on the supplied CD).

Shortcut for Save function:

The **Copy** button on the bottom right of the front panel is the shortcut for **Save** function in the **Utility** function menu. Pressing this button is equal to the **Save** option in the Save menu. The waveform, configure or the display screen could be saved according to the chosen type in the Save menu.

Save the current screen image:

The screen image can only be stored in USB disk, so you should connect a USB disk with the instrument.

1. **Install the USB disk:** Insert the USB disk into the "7. **USB Host port**" of "Figure 3-1 Front panel". If an icon  appears on the top right of the screen, the USB disk is installed successfully. If the USB disk cannot be recognized, format the USB disk according to the methods in "USB disk Requirements" on P31.
2. After the USB disk is installed, push the **Utility** button, select **Function** in the right menu, select **Save** in the left menu. In the right menu, select **Type** as **Image**.
3. Select **Save** in the right menu, an input keyboard used to edit the file name will pop up. The default name is current system date and time. Turn the **M** knob to choose the keys; press the **M** knob to input the chosen key. The length of file name is up to 25 characters. Select the  key in the keyboard to confirm.

USB disk Requirements

Support USB disk format: USB 2.0 or below, FAT16 or FAT32, allocation unit size no exceed 4k, max capacity 64G. If the USB disk doesn't work properly, format your USB disk and then try again. There are two methods in format the USB disk, first by using computer system to format, the other one is through formatting software to format. (8G or above USB disk can only use the second method to format, that is through formatting software to format.)

Use system-provided function to format the USB disk

1. Connect the USB disk to the computer.
2. Right click **Computer**-> **Manage** to enter Computer Management interface.
3. Click Disk Management menu, and information about the USB disk will display on the right side with red mark 1 and 2.

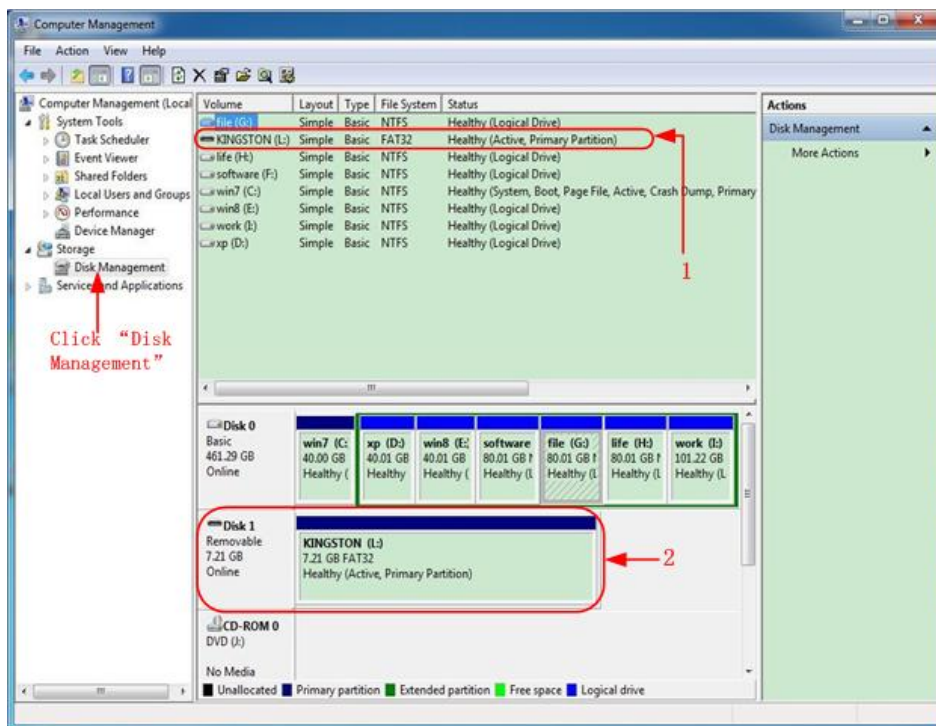

Figure 4-2: Disk Management of computer

- Right click 1 or 2 red mark area, choose **Format**. And system will pop up a warning message, click **Yes**.

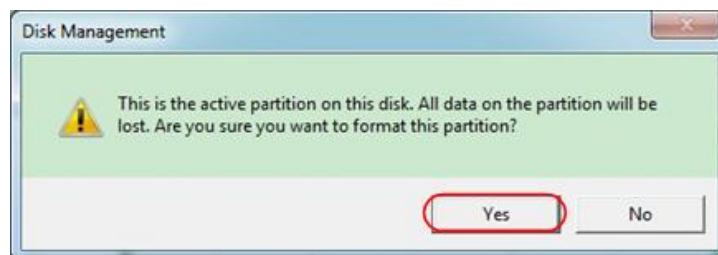

Figure 4-3: Format the USB disk warning

- Set File System as FAT32, Allocation unit size 4096. Check "**Perform a quick format**" to execute a quick format. Click **OK**, and then click **Yes** on the warning message.

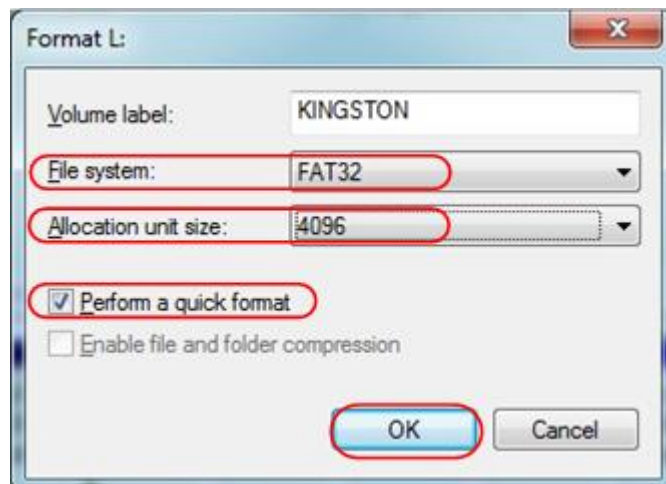

Figure 4-4: Formatting the USB disk setting

6. Formatting process.

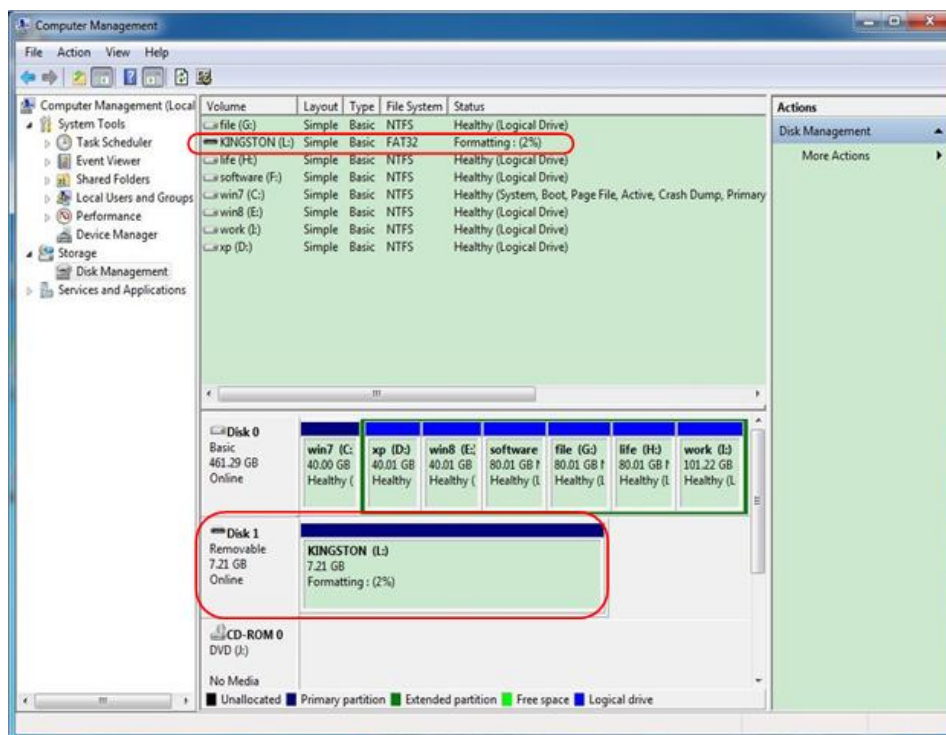

Figure 4- 5: Formatting the USB disk

7. Check whether the USB disk is FAT32 with allocation unit size 4096 after formatting.

Use Minitool Partition Wizard to format

Download URL: <http://www.partitionwizard.com/free-partition-manager.html>

Tip: There are many tools for the USB disk formatting on the market, just take Minitool Partition Wizard for example here.

1. Connect the USB disk to the computer.
2. Open the software **Minitool Partition Wizard**.
3. Click **Reload Disk** on the pull-down menu at the top left or push keyboard F5, and information about the USB disk will display on the right side with red mark 1 and 2.

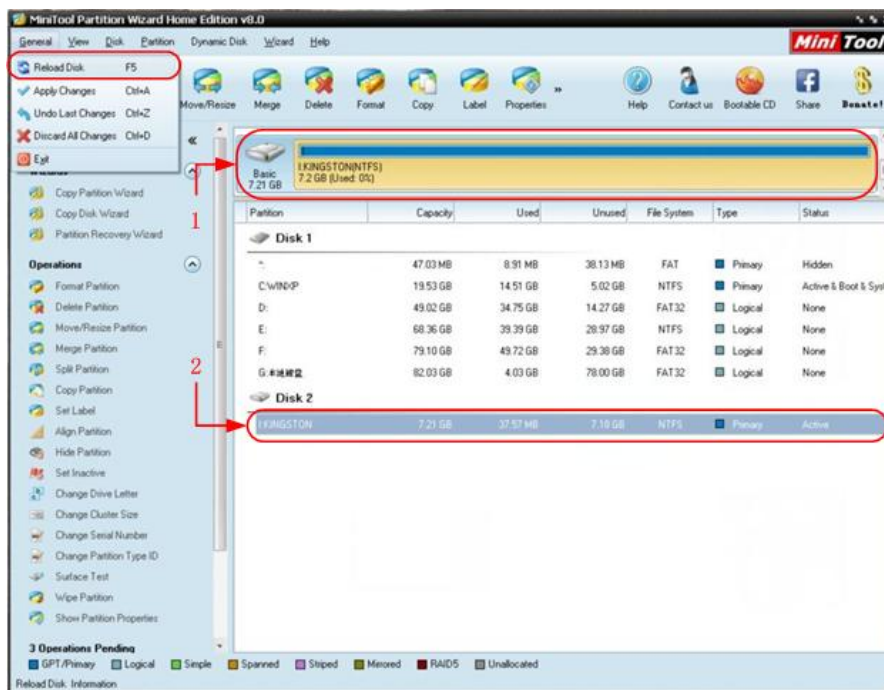

Figure 4-6: Reload Disk

- Right click 1 or 2 red mark area, choose **Format**.



Figure 4-7: Choose format

- Set File System FAT32, Cluster size 4096. Click **OK**.

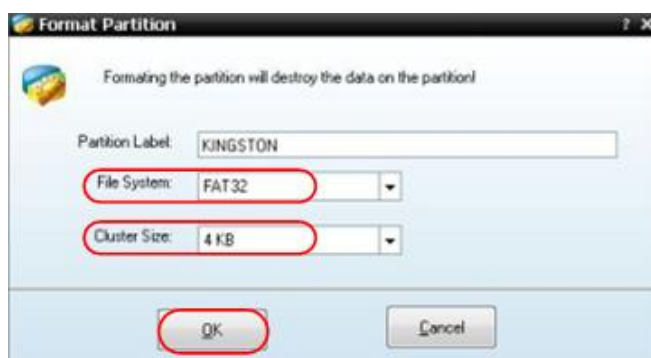

Figure 4-8: Format setting

- Click **Apply** at the top left of the menu. Then click **Yes** on the pop-up warning to begin formatting.



Figure 4-9: Apply setting

7. Formatting process

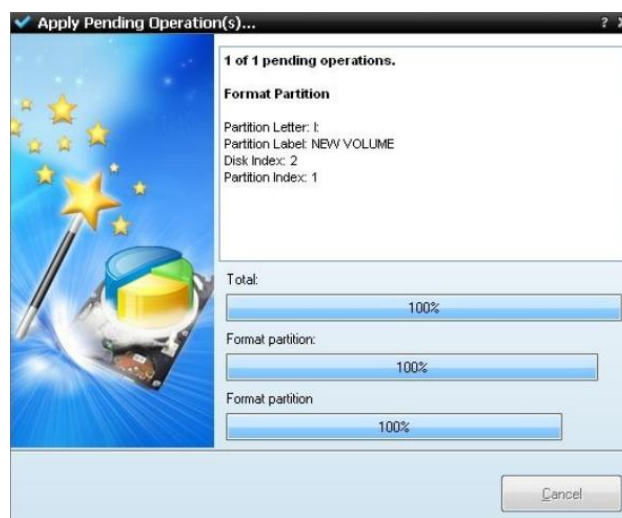

Figure 4-10: Format process

8. Format the USB disk successfully

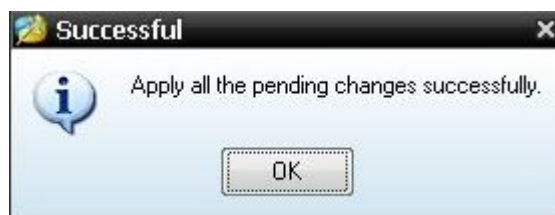

Figure 4-11: Format successfully

How to Implement the Auxiliary System Function Setting

●Configure

Push the **Utility** button, select **Function** in the right menu, select **Configure** in the left menu.

The description of **Configure Menu** is shown as the follows:

Function Menu	Setting	Description
Function	Configure	Show the configure menu.
Language		Select demand language.
KeyLock		Lock all keys. Unlock method: push Trigger Menu button in trigger control area, then push Force button, repeat 3 times.
Device	PC USBTMC U disk	Select device connected type.
About		Show the version and serial number

●Display

Push the **Utility** button, select **Function** in the right menu, select **Display** in the left menu.

The description of **Display Menu** is shown as the follows:

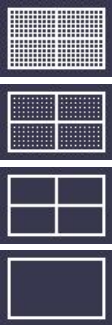
Function Menu	Setting	Description
Function	Display	Show the display menu.
BackLight	0% - 100%	Turn the M knob to adjust the backlight.
Graticule		Select the grid type.
Menu Time	OFF, 5S – 30S	Turn the M knob to set the disappear time of menu.

●Adjust

Push the **Utility** button, select **Function** in the right menu, select **Adjust** in the left menu.

The description of **Adjust Menu** is shown as the follows:

Function Menu	Description
Self Cal	Carry out the self-calibration procedure.
Default	Call out the factory settings.
ProbeCh.	Check whether probe attenuation is good.

Do Self Cal (Self-Calibration)

The self-calibration procedure can improve the accuracy of the oscilloscope under the ambient temperature to the greatest extent. If the change of the ambient temperature is up to or exceeds 5°C, the self-calibration procedure should be executed to obtain the highest level of accuracy.

Before executing the self-calibration procedure, disconnect all probes or wires from the input connector. Push the **Utility** button, select **Function** in the right menu, the function menu will display at the left, select **Adjust**. If everything is ready, select **Self Cal** in the right menu to enter the self-calibration procedure of the instrument.

Probe checking

To check whether probe attenuation is good. The results contain three circumstances: Overflow compensation, Good compensation, Inadequate compensation. According to the checking result, users can adjust probe attenuation to the best. Operation steps are as follows:

1. Connect the probe to CH1, adjust the probe attenuation to the maximum.
2. Push the **Utility** button, select **Function** in the right menu, select **Adjust** in the left menu.
3. Select **ProbeCh.** in the right menu, tips about probe checking shows on the screen.
4. Select **ProbeCh.** again to begin probe checking and the checking result will occur after 3s; push any other key to quit.

● Save

You can save the waveforms, configures or screen images. Refer to "*How to Save and Recall a Waveform*" on page 28.

● Update

Use the front-panel USB port to update your instrument firmware using a USB memory device. Refer to "*How to Update your Instrument Firmware*" on page 37.

How to Update your Instrument Firmware

Use the front-panel USB port to update your instrument firmware using a USB memory device.

USB memory device requirements: Insert a USB memory device into the USB port on the front panel. If the icon  appears on the top right of the screen, the USB memory device is installed successfully. If the USB memory device cannot be detected, format the USB memory device according to the methods in "*USB disk Requirements*" on P31.

Caution: Updating your instrument firmware is a sensitive operation, to prevent damage to the instrument, do not power off the instrument or remove the USB memory device during the update process.

To update your instrument firmware, do the following:

1. Push the **Utility** button, select **Function** in the right menu, select **Configure** in the left menu, select **About** in the right menu. View the model and the currently installed firmware version.
2. From a PC, visit www.owon.com.cn and check if the website offers a newer firmware version. Download the firmware file. The file name must be Scope.update. Copy the firmware file onto the root directory of your USB memory device.
3. Insert the USB memory device into the front-panel USB port on your instrument.

4. Push the **Utility** button, select **Function** in the right menu, select **Update** in the left menu.
5. In the right menu, select **Start**, the messages below will be shown.

```
The root directory of the udisk
must contain Socpe.update.
Do not power off the instrument.
The internal data will be cleared.
Press <start> to execute.
Press any key to quit.
```

6. In the right menu, select **Start** again, the interfaces below will be displayed in sequence. The update process will take up to three minutes. After completion, the instrument will be shut down automatically.

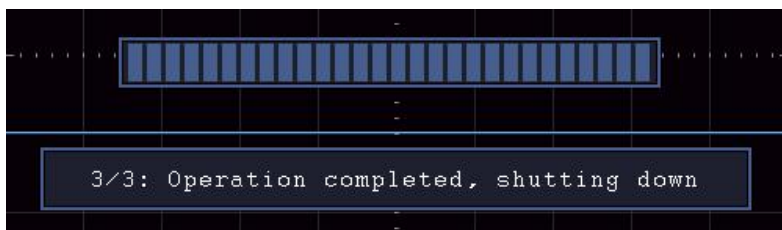
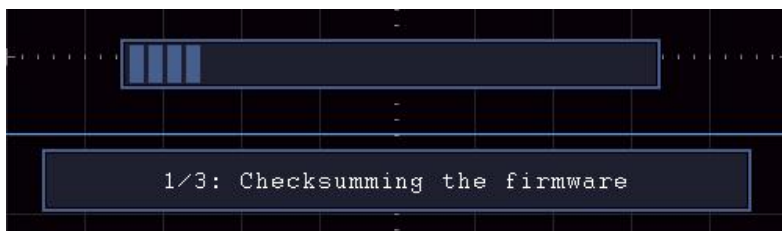

7. Press the  button to power on the instrument.

How to Measure Automatically

Push the **Measure** button to display the menu for the settings of the Automatic Measurements. At most 8 types of measurements could be displayed on the bottom left of the screen.

The oscilloscopes provide 30 parameters for auto measurement, including Period, Frequency, Mean, PK-PK, RMS, Max, Min, Top, Base, Amplitude, Overshoot, Preshoot, Rise Time, Fall Time, +PulseWidth, -PulseWidth, +Duty Cycle, -Duty Cycle, Delay A→B Φ , Delay A→B Ψ , Cycle RMS, Cursor RMS, Screen Duty, Phase, +PulseCount, -PulseCount, RiseEdgeCnt, FallEdgeCnt, Area, and Cycle Area.

The "Automatic Measurements" menu is described as the following table:

Function Menu	Setting	Description
AddCH1	Meas Type (left menu)	Press to show the left menu, turn the M knob to select the measure type, press AddCH1 again to add the selected measure type of CH1.
AddCH2	Meas Type (left menu)	Press to show the left menu, turn the M knob to select the measure type, press AddCH2 again to add the selected measure type of CH2.
Show	OFF CH1 CH2	Hide the window of measures. Show all the measures of CH1 on the screen. Show all the measures of CH2 on the screen.
Remove	Meas Type (left menu)	Press to show the left menu, turn the M knob to select the type need to be deleted, press Remove again to remove the selected measure type.
Remove All		Remove all the measures.

Measure

Only if the waveform channel is in the ON state, the measurement can be performed. The automatic measurement can not be performed in the following situation: 1) On the saved waveform. 2) On the Dual Wfm Math waveform. 3) On the Video trigger mode. On the Scan format, period and frequency can not be measured.

Measure the period, the frequency of the CH1, following the steps below:

1. Push the **Measure** button to show the right menu.
2. Select **AddCH1** in the right menu.
3. In the left Type menu, turn the **M** knob to select **Period**.
4. In the right menu, select **AddCH1**. The period type is added.
5. In the left Type menu, turn the **M** knob to select **Frequency**.
6. In the right menu, select **AddCH1**. The frequency type is added.

The measured value will be displayed at the bottom left of the screen automatically (see *Figure 4-12*).

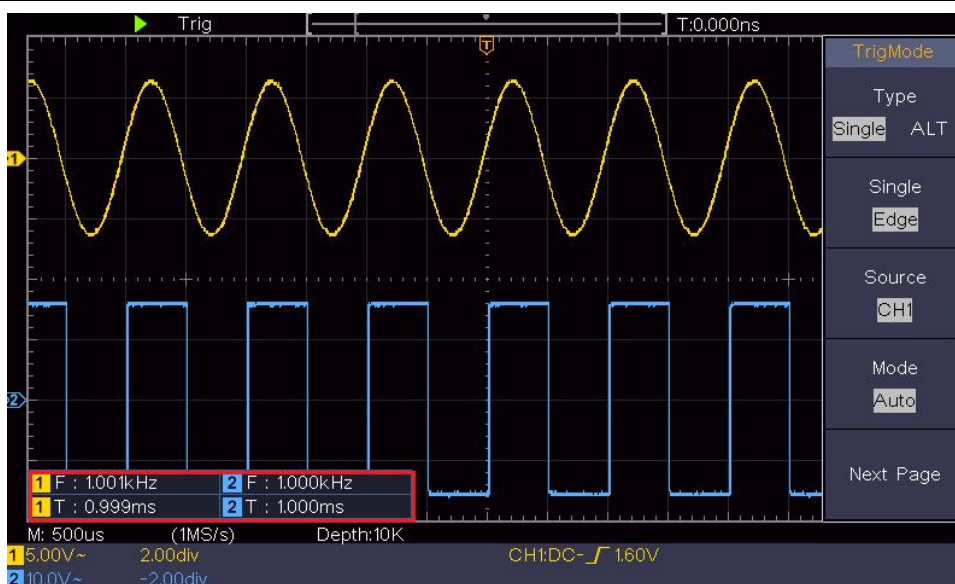

Figure 4- 12 Automatic measurement

The automatic measurement of voltage parameters

The oscilloscopes provide automatic voltage measurements including Mean, PK-PK, RMS, Max, Min, Vtop, Vbase, Vamp, OverShoot, PreShoot, Cycle RMS, and Cursor RMS. *Figure 4- 13* below shows a pulse with some of the voltage measurement points.

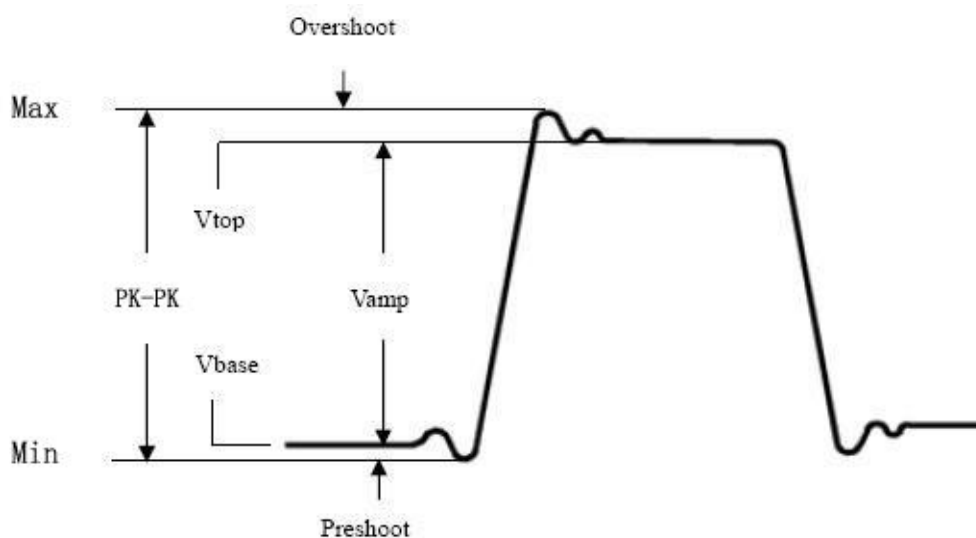

Figure 4- 13

Mean: The arithmetic mean over the entire waveform.

PK-PK: Peak-to-Peak Voltage.

RMS: The true Root Mean Square voltage over the entire waveform.

Max: The maximum amplitude. The most positive peak voltage measured over the entire waveform.

Min: The minimum amplitude. The most negative peak voltage measured over the entire waveform.

Top: Voltage of the waveform's flat top, useful for square/pulse waveforms.

Base: Voltage of the waveform's flat base, useful for square/pulse waveforms.

Amplitude: Voltage between Vtop and Vbase of a waveform.

Overshoot: Defined as $(V_{max}-V_{top})/V_{amp}$, useful for square and pulse waveforms.

Preshoot: Defined as $(V_{min}-V_{base})/V_{amp}$, useful for square and pulse waveforms.

Cycle RMS: The true Root Mean Square voltage over the first entire period of the waveform.

Cursor RMS: The true Root Mean Square voltage over the range of two cursors.

The automatic measurement of time parameters

The oscilloscopes provide time parameters auto-measurements include Period, Frequency, Rise Time, Fall Time, +D width, -D width, +Duty, -Duty, Delay A→B ⏏ , Delay A→B ⏏ , and Duty cycle.

Figure 4- 14 shows a pulse with some of the time measurement points.

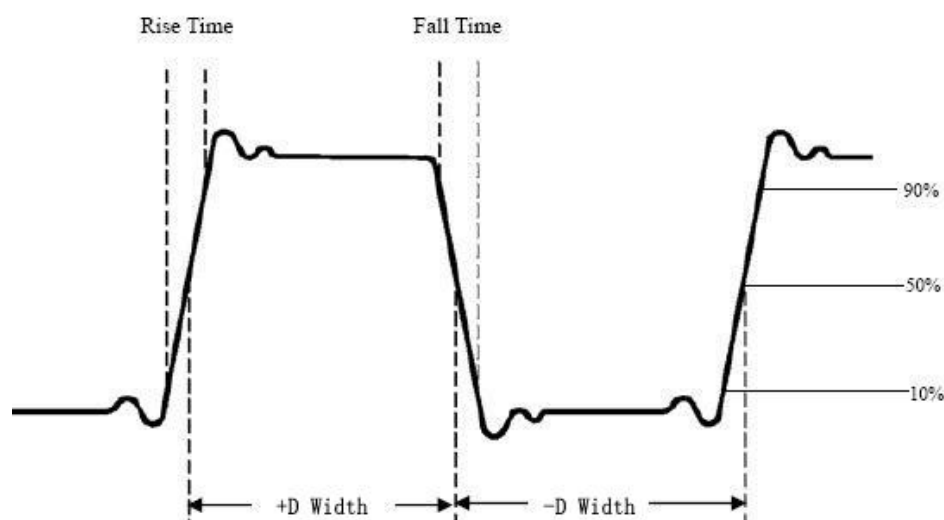

Figure 4- 14

Rise Time: Time that the leading edge of the first pulse in the waveform takes to rise from 10% to 90% of its amplitude.

Fall Time: Time that the falling edge of the first pulse in the waveform takes to fall from 90% to 10% of its amplitude.

+PulseWidth: The width of the first positive pulse in 50% amplitude points.

-PulseWidth: The width of the first negative pulse in the 50% amplitude points.

+Duty Cycle: +Duty Cycle, defined as $+Width/Period$.

-Duty Cycle: -Duty Cycle, defined as $-Width/Period$.

Delay A→B ⏏ : The delay between the two channels at the rising edge.

Delay A→B ⏏ : The delay between the two channels at the falling edge.

Screen Duty: Defines as $(\text{the width of the positive pulse})/(\text{Entire period})$

Phase: Compare the rising edge of CH1 and CH2, calculate phase difference of two channels.

Phase difference = $(\text{Delay between channels at the rising edge} \div \text{Period}) \times 360^\circ$.

Other measurements

+PulseCount : The number of positive pulses that rise above the mid reference crossing in the waveform.

-PulseCount : The number of negative pulses that fall below the mid reference crossing in the waveform.

RiseEdgeCnt : The number of positive transitions from the low reference value to the high reference value in the waveform.

FallEdgeCnt : The number of negative transitions from the high reference value to the low reference value in the waveform.

Area : The area of the whole waveform within the screen and the unit is voltage-second. The area measured above the zero reference (namely the vertical offset) is positive; the area measured below the zero reference is negative. The area measured is the algebraic sum of the area of the whole waveform within the screen.

Cycle Area : The area of the first period of waveform on the screen and the unit is voltage-second. The area above the zero reference (namely the vertical offset) is positive and the area below the zero reference is negative. The area measured is the algebraic sum of the area of the whole period waveform.

Note: When the waveform on the screen is less than a period, the period area measured is 0.

How to Measure with Cursors

Push the **Cursor** button to turn cursors on and display the cursor menu. Push it again to turn cursors off.

The Cursor Measurement for normal mode:

The description of the **cursor menu** is shown as the following table:

Function Menu	Setting	Description
Type	Voltage	Display the voltage measurement cursor and menu.
	Time	Display the time measurement cursor and menu.
	Time&Voltage	Display the time and voltage measurement cursor and menu.
	AutoCursr	The horizontal cursors are set as the intersections of the vertical cursors and the waveform.
Line Type (Time&Voltage type)	Time	Makes the vertical cursors active.
	Voltage	Makes the horizontal cursors active.
Window (Wave zoom mode)	Main	Measure in the main window.
	Extension	Measure in the extension window.
Line	a	Turn the M knob to move line a.

	b ab	Turn the M knob to move line b. Two cursors are linked. Turn the M knob to move the pair of cursors.
Source	CH1 CH2	Display the channel to which the cursor measurement will be applied.

Perform the following operation steps for the time and voltage cursor measurement of the channel CH1:

1. Push **Cursor** to display the cursor menu.
2. In the right menu, select **Source** as **CH1**.
3. Press the first menu item in the right menu, select **Time&Voltage** for Type, two blue dotted lines displayed along the horizontal direction of the screen, two blue dotted lines displayed along the vertical direction of the screen. Cursor measure window at the left bottom of the screen shows the cursor readout.
4. In the right menu, select **Line Type** as **Time** to make the vertical cursors active. If the **Line** in the right menu is select as **a**, turn the **M** knob to move line a to the right or left. If **b** is selected, turn the **M** knob to move line b.
5. In the right menu, select **Line Type** as **Voltage** to make the horizontal cursors active. Select **Line** in the right menu as **a** or **b**, turn the **M** knob to move it.
6. Push the horizontal **HOR** button to enter wave zoom mode. Push **Cursor** to show the right menu, select **Window** as **Main** or **Extension** to make the cursors shown in the main window or zoom window.

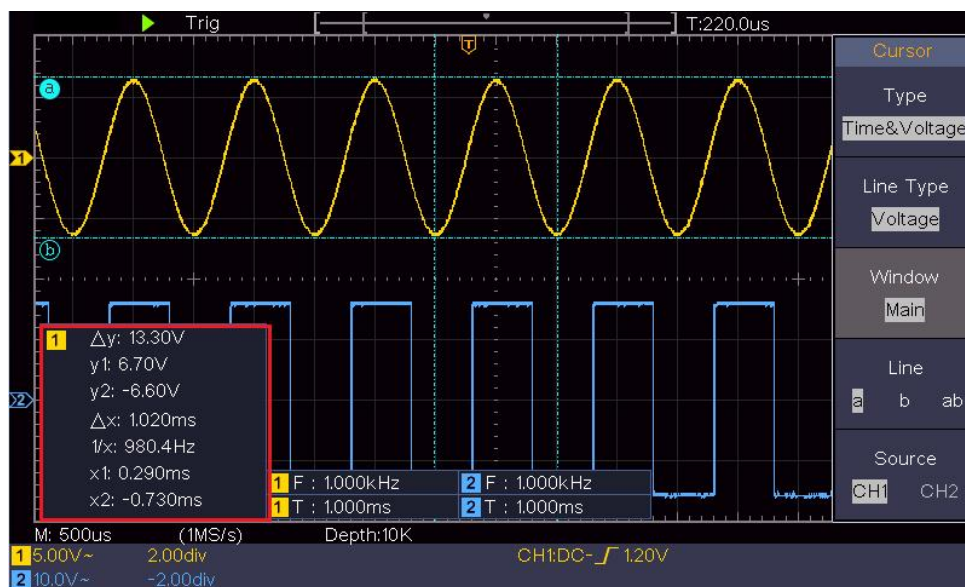
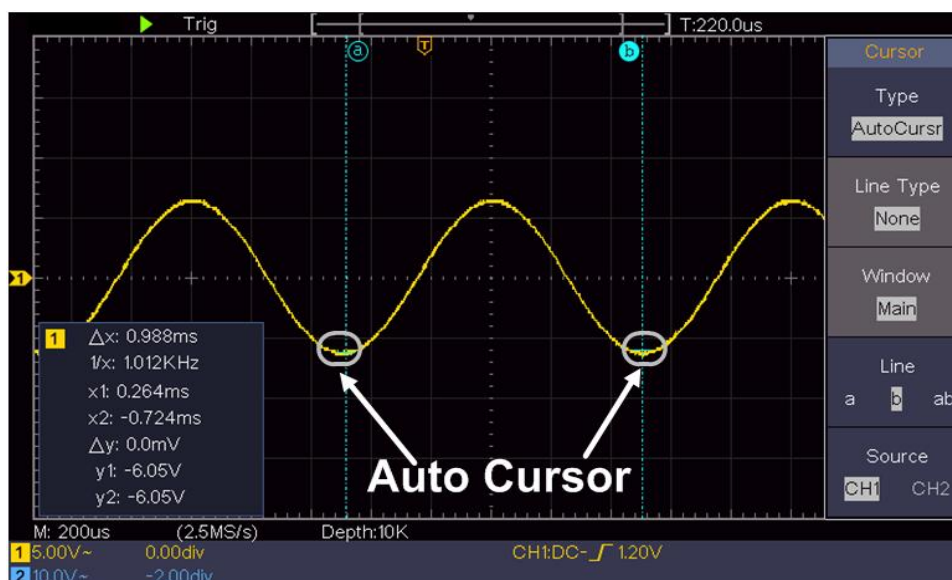

Figure 4- 15 Time&Voltage Cursor Measurement

Auto Cursor

For the AutoCursor type, the horizontal cursors are set as the intersections of the vertical cursors and the waveform.



The Cursor Measurement for FFT mode

In FFT mode, push the **Cursor** button to turn cursors on and display the cursor menu.

The description of the **cursor menu** in FFT mode is shown as the following table:

Function Menu	Setting	Description
Type	Vamp	Display the Vamp measurement cursor and menu.
	Freq	Display the Freq measurement cursor and menu.
	Freq&Vamp	Display the Freq and Vamp measurement cursor and menu.
	AutoCursr	The horizontal cursors are set as the intersections of the vertical cursors and the waveform
Line Type (Freq&Vamp type)	Freq Vamp	Makes the vertical cursors active. Makes the horizontal cursors active.
Window (Wave zoom mode)	Main Extension	Measure in the main window. Measure in the FFT extension window.
Line	a b ab	Turn the M knob to move line a. Turn the M knob to move line b. Two cursors are linked. Turn the M knob to move the pair of cursors.
Source	Math FFT	Display the channel to which the cursor measurement will be applied.

Perform the following operation steps for the amplitude and frequency cursor measurement of math FFT:

1. Press the **Math** button to display the right menu. Select **Type** as **FFT**.
2. Push **Cursor** to display the cursor menu.
3. In the right menu, select **Window** as **Extension**.
4. Press the first menu item in the right menu, select **Freq&Vamp** for Type, two

blue dotted lines displayed along the horizontal direction of the screen, two blue dotted lines displayed along the vertical direction of the screen. Cursor measure window at the left bottom of the screen shows the cursor readout.

5. In the right menu, select **Line Type** as **Freq** to make the vertical cursors active. If the **Line** in the right menu is select as **a**, turn the **M** knob to move line a to the right or left. If **b** is selected, turn the **M** knob to move line b.
6. In the right menu, select **Line Type** as **Vamp** to make the horizontal cursors active. Select **Line** in the right menu as **a** or **b**, turn the **M** knob to move it.
7. In the right cursor menu, you can select **Window** as **Main** to make the cursors shown in the main window.

How to Use Executive Buttons

Executive Buttons include **Autoset**, **Run/Stop**, **Copy**.

● [Autoset] button

It's a very useful and quick way to apply a set of pre-set functions to the incoming signal, and display the best possible viewing waveform of the signal and also works out some measurements for user as well.

The details of functions applied to the signal when using **Autoset** are shown as the following table:

Function Items	Setting
Vertical Coupling	Current
Channel Coupling	Current
Vertical Scale	Adjust to the proper division.
Horizontal Level	Middle or ± 2 div
Horizontal Sale	Adjust to the proper division
Trigger Type	Slope or Video
Trigger Source	CH1 or CH2
Trigger Coupling	DC
Trigger Slope	Current
Trigger Level	3/5 of the waveform
Trigger Mode	Auto
Display Format	YT
Force	Stop
Inverted	Off
Zoom Mode	Exit

Judge waveform type by Autoset

Five kinds of types: Sine, Square, video signal, DC level, Unknown signal.

Menu as follow:

Waveform	Menu
Sine	Multi-period, Single-period, FFT, Cancel Autoset

Square	Multi-period, Single-period, Rising Edge, Falling Edge, Cancel Autoset
Video signal	Type (line, field), Odd, Even, Line NO., Cancel Autoset
DC level/Unknown signal	Cancel Autoset

Description for some icons:

Multi-period: To display multiple periods

Single-period: To display single period

FFT: Switch to FFT mode

Rising Edge: Display the rising edge of square waveform

Falling Edge: Display the falling edge of square waveform

Cancel Autoset: Go back to display the upper menu and waveform information

Note: The Autoset function requires that the frequency of signal should be no lower than 20Hz, and the amplitude should be no less than 5mv. Otherwise, the Autoset function may be invalid.

- **[Run/Stop] button**

Enable or disable sampling on input signals.

Notice: When there is no sampling at STOP state, the vertical division and the horizontal time base of the waveform still can be adjusted within a certain range, in other words, the signal can be expanded in the horizontal or vertical direction.

When the horizontal time base is $\leq 50\text{ms}$, the horizontal time base can be expanded for 4 divisions downwards.

- **[Copy] button**

This button is the shortcut for **Save** function in the **Utility** function menu. Pressing this button is equal to the **Save** option in the Save menu. The waveform, configure or the display screen could be saved according to the chosen type in the Save menu. For more details, please see "*How to Save and Recall a Waveform*" on P28.

5. Communication with PC

The oscilloscope supports communications with a PC through USB. You can use the Oscilloscope communication software to store, analyze, display the data and remote control.

For the specific operation method of Oscilloscope host software, please download and view the host help document on our download website.

Here is how to connect with PC via USB port.

- (1) **Set the USB device protocol type of the instrument:** Click Utility → Function → Function → Configure → Device ,switch to PC.
- (2) **Connection:** Use a USB data cable to connect the **USB Device port** in the right panel of the Oscilloscope to the USB port of a PC.
- (3) **Port setting of the software:** Run the Oscilloscope software; click "Communications" on the menu bar, choose "Ports-Settings", in the setting dialog, choose "Connect using" as "USB". After connect successfully, the connection information in the bottom right corner of the software will turn green.

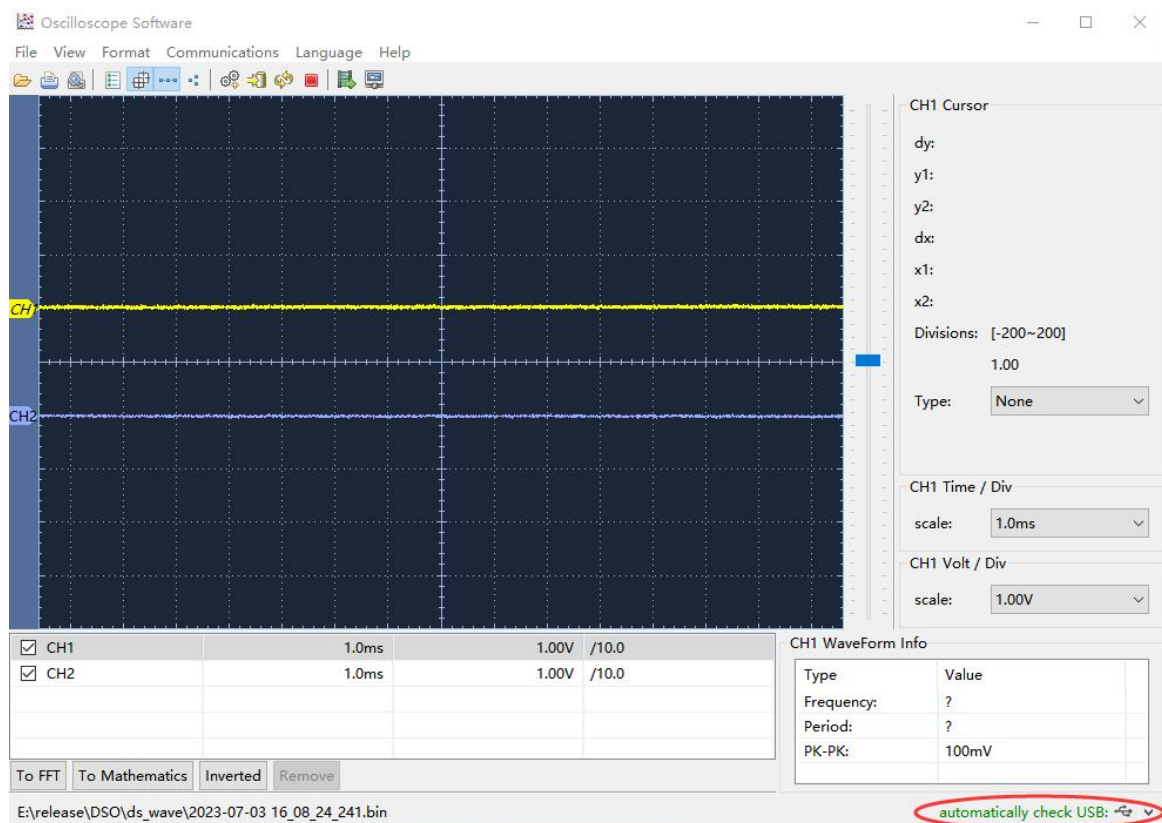

Figure 5- 1 Connect with PC through USB port

6. Demonstration

Example 1: Measurement a Simple Signal

The purpose of this example is to display an unknown signal in the circuit, and measure the frequency and peak-to-peak voltage of the signal.

1. Carry out the following operation steps for the rapid display of this signal:

- (1) Set the probe menu attenuation coefficient as **10X** and that of the switch in the probe switch as **10X** (see "*How to Set the Probe Attenuation Coefficient*" on P11).
- (2) Connect the probe of **Channel 1** to the measured point of the circuit.
- (3) Push the **Autoset** button.

The oscilloscope will implement the **Autoset** to make the waveform optimized, based on which, you can further regulate the vertical and horizontal divisions till the waveform meets your requirement.

2. Perform Automatic Measurement

The oscilloscope can measure most of the displayed signals automatically. To measure the period, the frequency of the CH1, following the steps below:

- (1) Push the **Measure** button to show the right menu.
- (2) Select **AddCH1** in the right menu.
- (3) In the left Type menu, turn the **M** knob to select **Period**.
- (4) In the right menu, select **AddCH1**. The period type is added.
- (5) In the left Type menu, turn the **M** knob to select **Frequency**.
- (6) In the right menu, select **AddCH1**. The frequency type is added.

The measured value will be displayed at the bottom left of the screen automatically (see *Figure 6- 1*).

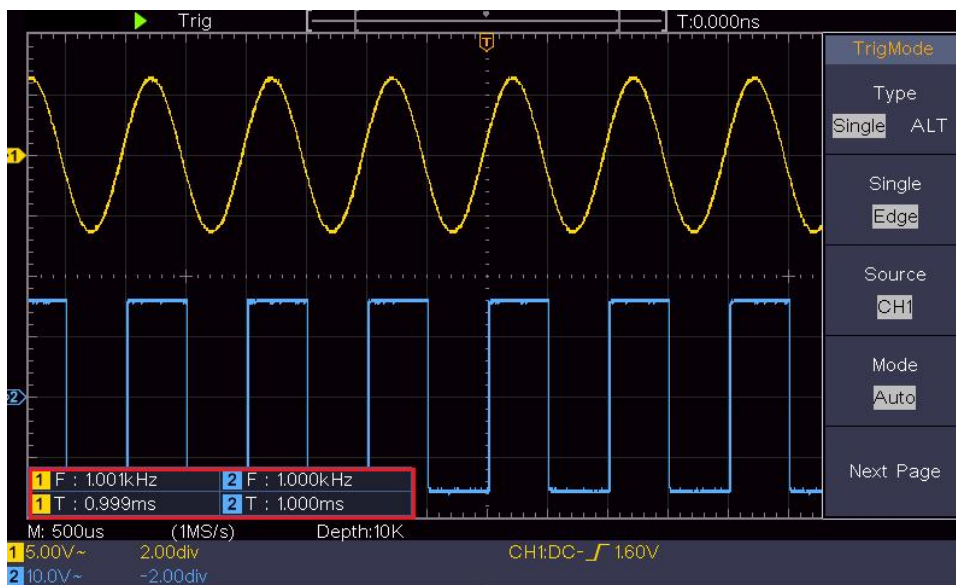

Figure 6- 1 Measure period and frequency value for a given signal

Example 2: Gain of a Amplifier in a Metering Circuit

The purpose of this example is to work out the Gain of an Amplifier in a Metering Circuit. First we use Oscilloscope to measure the amplitude of input signal and output

signal from the circuit, then to work out the Gain by using given formulas.

Set the probe menu attenuation coefficient as **10X** and that of the switch in the probe as **10X** (see "*How to Set the Probe Attenuation Coefficient*" on P11).

Connect the oscilloscope CH1 channel with the circuit signal input end and the CH2 channel to the output end.

Operation Steps:

- (1) Push the **Autoset** button and the oscilloscope will automatically adjust the waveforms of the two channels into the proper display state.
- (2) Push the **Measure** button to show the right menu.
- (3) Select **AddCH1** in the right menu.
- (4) In the left Type menu, turn the **M** knob to select **PK-PK**.
- (5) In the right menu, select **AddCH1**. The peak-to-peak type of CH1 is added.
- (6) In the right menu, select **AddCH2**. The peak-to-peak type of CH2 is added.
- (7) Read the peak-to-peak voltages of Channel 1 and Channel 2 from the bottom left of the screen (see *Figure 6-2*).
- (8) Calculate the amplifier gain with the following formulas.

$$\text{Gain} = \text{Output Signal} / \text{Input signal}$$

$$\text{Gain (db)} = 20 \times \log(\text{gain})$$

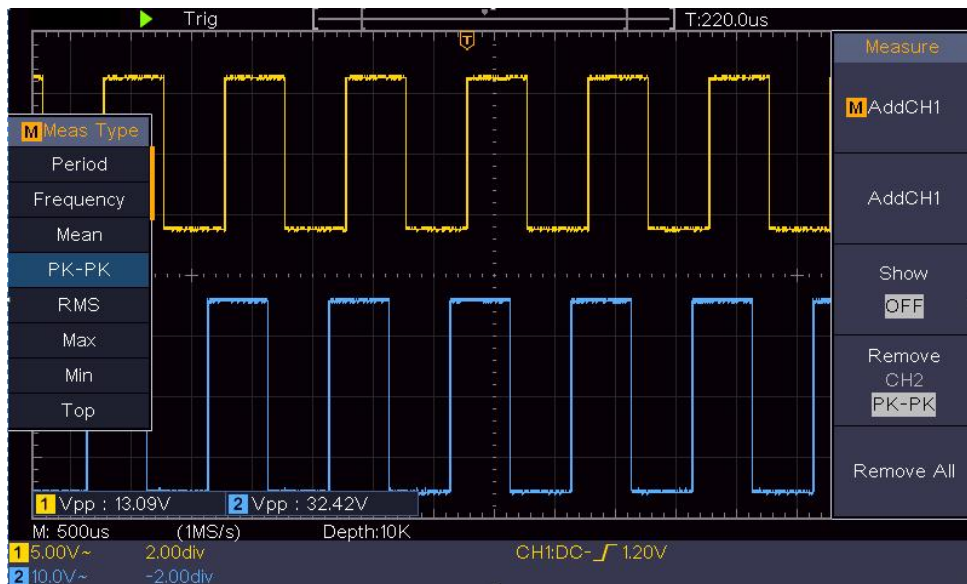



Figure 6-2 Waveform of Gain Measurement

Example 3: Capturing a Single Signal

It's quite easy to use Digital Oscilloscope to capture non-periodic signal, such as a pulse and burr etc. But the common problem is how to set up a trigger if you have no knowledge of the signal? For example, if the pulse is the logic signal of a TTL level,

the trigger level should be set to 2 volts and the trigger edge be set as the rising edge trigger. With various functions supported by our Oscilloscope, user can solve this problem by taking an easy approach. First to run your test using auto trigger to find out the closest trigger level and trigger type, this helps user to make few small adjustments to achieve a proper trigger level and mode. Here is how we achieve this.

The operation steps are as follows:

- (1) Set the probe menu attenuation coefficient to 10X and that of the switch in the probe to 10X (see "*How to Set the Probe Attenuation Coefficient*" on P11).
- (2) Adjust the **Vertical Scale** and **Horizontal Scale** knobs to set up a proper vertical and horizontal ranges for the signal to be observed.
- (3) Push the **Acquire** button to display the right menu.
- (4) In the right menu, select **Acqu Mode** as **Peak Detect**.
- (5) Push the **Trigger Menu** button to display the right menu.
- (6) In the right menu, select **Type** as **Single**.
- (7) In the right menu, select **Single** as **Edge**.
- (8) In the right menu, select **Source** as **CH1**.
- (9) In the right menu, press **Next Page**, select **Coupling** as **DC**.
- (10) In the right menu, select **Slope** as  (rising).
- (11) Turn the **Trigger Level** knob and adjust the trigger level to the roughly 50% of the signal to be measured.
- (12) Check the Trigger State Indicator on the top of the screen, if it is not Ready, push down the **Run/Stop** button and start acquiring, wait for trigger to happen. If a signal reaches to the set trigger level, one sampling will be made and then displayed in the screen. By using this approach, a random pulse can be captured easily. For instance, if we want to find a burst burr of high amplitude, set the trigger level to a slightly higher value of the average signal level, push the **Run/Stop** button and wait a trigger. Once there is a burr occurring, the instrument will trigger automatically and record the waveform during the period around the trigger time. By turning the **Horizontal Position** knob in the horizontal control area in the panel, you can change the horizontal triggering position to obtain the negative delay, making an easy observation of the waveform before the burr occurs (see *Figure 6-3*).

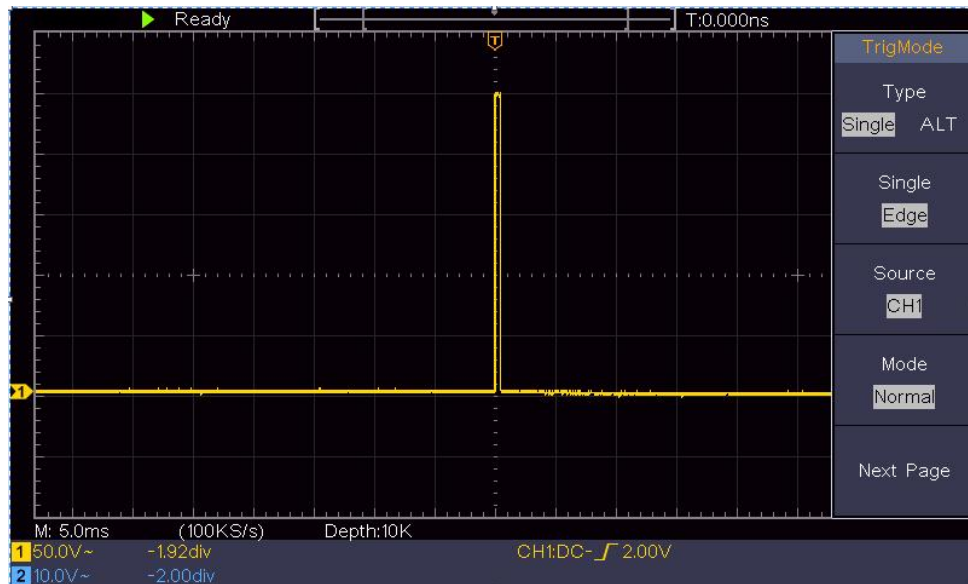

Figure 6- 3 Capturing a Single Signal

Example 4: Analyze the Details of a Signal

Noise is very common inside most of the electronic signal. To find out what's inside the noise and reduce the level of noise is very important function our oscilloscope is capable to offer.

Noise Analysis

The level of noise sometime indicates a failure of electronic circuit. The Peak Detect functions acts an important role to help you to find out the details of these noise. Here is how we do it:

- (1) Push the **Acquire** button to display the right menu.
- (2) In the right menu, select **Acqu Mode** as **Peak Detect**.

The signal displayed on the screen containing some noise, by turning on Peak Detect function and changing time base to slow down the incoming signal, any peaks or burr would be detected by the function (see *Figure 6- 4*).

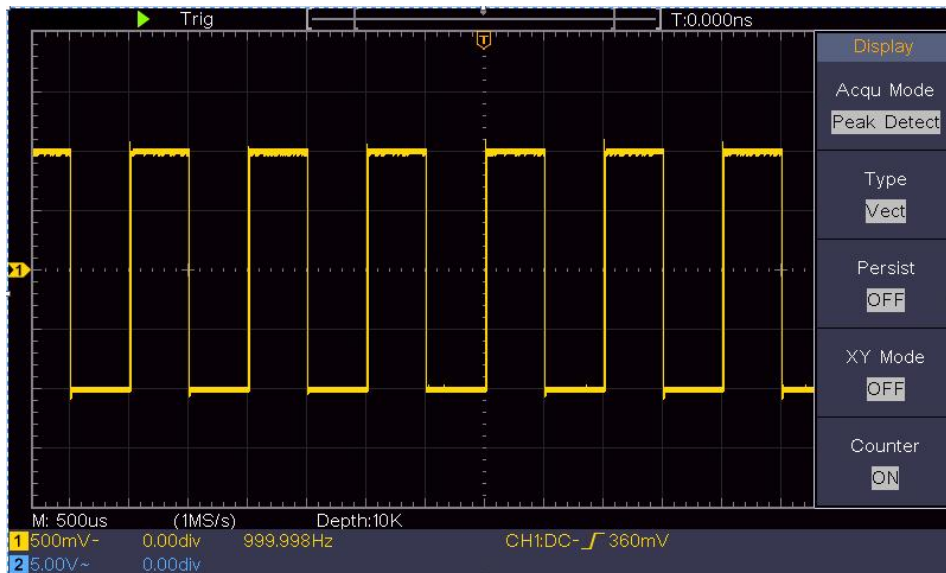

Figure 6-4 Signal with Noises

Separate Noises from the Signal

When focusing on signal itself, the important thing is to reduce the noise level as lower as possible, this would enable user to have more details about the signal. The Average function offered by our Oscilloscope can help you to achieve this.

Here are the steps for how to enable Average function.

- (1) Push the **Acquire** button to display the right menu.
- (2) In the right menu, select **Acqu Mode** as **Average**.
- (3) Turn the **M** knob and observe the waveform obtained from averaging the waveforms of different average number.

User would see a much reduced random noise level and make it easy to see more details of the signal itself. After applying Average, user can easily identify the burrs on the rising and falling edges of some part of the signal (see *Figure 6-5*).

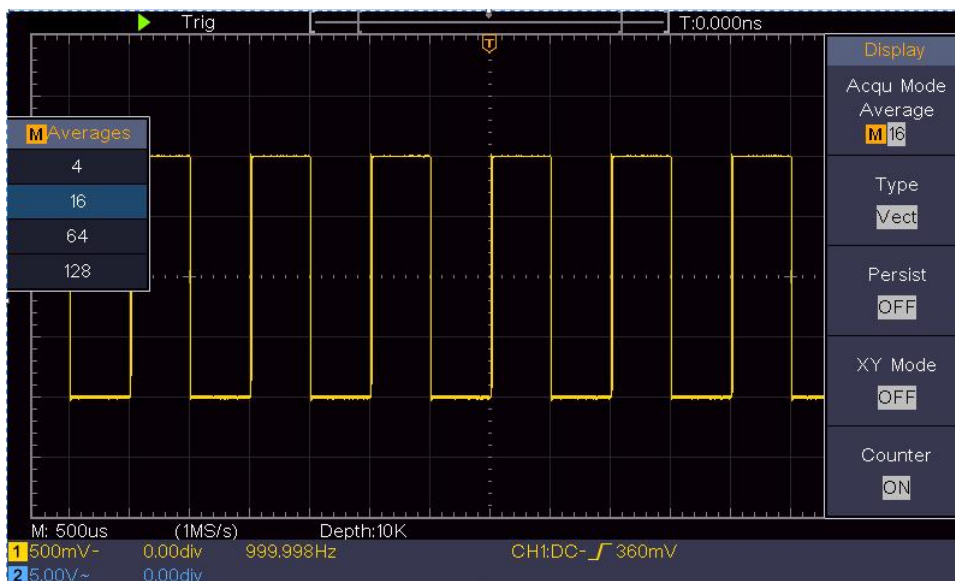

Figure 6-5 Reduce Noise level by using Average function

Example 5: Application of X-Y Function

Examine the Phase Difference between Signals of two Channels

Example: Test the phase change of the signal after it passes through a circuit network.

X-Y mode is a very useful when examining the Phase shift of two related signals. This example takes you step by step to check out the phase change of the signal after it passes a specified circuit. Input signal to the circuit and output signal from circuit are used as source signals.

For the examination of the input and output of the circuit in the form of X-Y coordinate graph, please operate according to the following steps:

- (1) Set the probe menu attenuation coefficient for **10X** and that of the switch in the probe for **10X** (see "*How to Set the Probe Attenuation Coefficient*" on P11).
- (2) Connect the probe of channel 1 to the input of the network and that of Channel 2 to the output of the network.
- (3) Push the **Autoset** button, with the oscilloscope turning on the signals of the two channels and displaying them in the screen.
- (4) Turn the **Vertical Scale** knob, making the amplitudes of two signals equal in the rough.
- (5) Push the **Acquire** button to display the right menu.
- (6) In the right menu, select **XY Mode** as **ON**. The oscilloscope will display the input and terminal characteristics of the network in the Lissajous graph form.
- (7) Turn the **Vertical Scale** and **Vertical Position** knobs, optimizing the waveform.
- (8) With the elliptical oscillogram method adopted, observe and calculate the phase difference (see *Figure 6-6*).

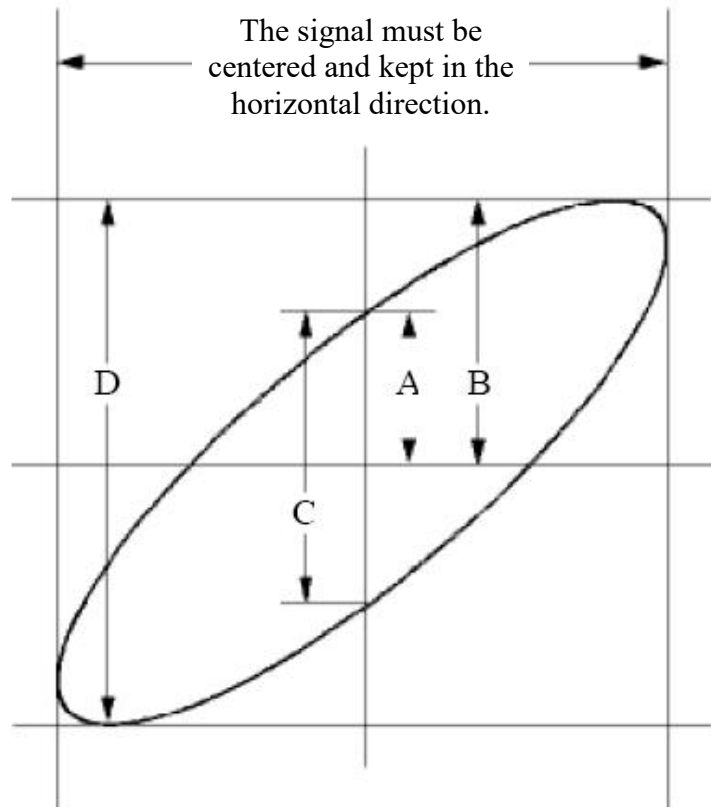

Figure 6-6 Lissajous Graph

Based on the expression $\sin(\mathbf{q}) = \mathbf{A/B}$ or $\mathbf{C/D}$, thereinto, \mathbf{q} is the phase difference angle, and the definitions of A, B, C, and D are shown as the graph above. As a result, the phase difference angle can be obtained, namely, $\mathbf{q} = \pm \arcsin(\mathbf{A/B})$ or $\pm \arcsin(\mathbf{C/D})$. If the principal axis of the ellipse is in the I and III quadrants, the determined phase difference angle should be in the I and IV quadrants, that is, in the range of $(0 - \pi/2)$ or $(3\pi/2 - 2\pi)$. If the principal axis of the ellipse is in the II and IV quadrants, the determined phase difference angle is in the II and III quadrants, that is, within the range of $(\pi/2 - \pi)$ or $(\pi - 3\pi/2)$.

Example 6: Video Signal Trigger

Observe the video circuit of a television, apply the video trigger and obtain the stable video output signal display.

Video Field Trigger

For the trigger in the video field, carry out operations according to the following steps:

- (1) Push the **Trigger Menu** button to display the right menu.
- (2) In the right menu, select **Type** as **Single**.
- (3) In the right menu, select **Single** as **Video**.
- (4) In the right menu, select **Source** as **CH1**.

- (5) In the right menu, select **Modu** as **NTSC**.
- (6) In the right menu, press **Next Page**, select **Sync** as **Field**.
- (7) Turn the **Vertical Scale**, **Vertical Position** and **Horizontal Scale** knobs to obtain a proper waveform display (see *Figure 6-7*).

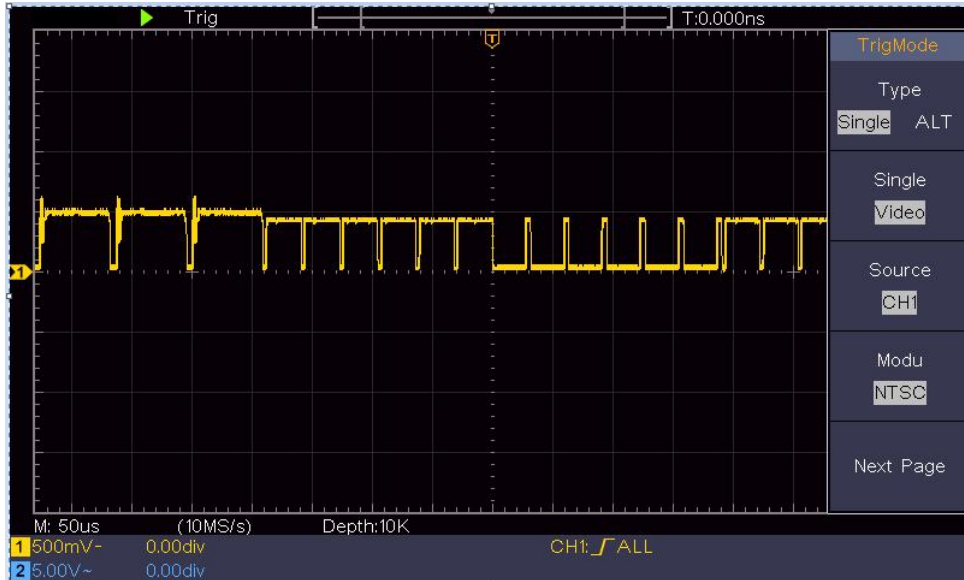

Figure 6-7 Waveform Captured from Video Field Trigger

7. Troubleshooting

1. Oscilloscope is powered on but no Display.

- Check whether the power connection is connected properly.
- Restart the instrument after completing the checks above.
- If the problem persists, please contact us and we will be under your service.

2. After acquiring the signal, the waveform of the signal is not displayed in the screen.

- Check whether the probe is properly connected to the signal connecting wire.
- Check whether the signal connecting wire is correctly connected to the BNC (namely, the channel connector).
- Check whether the probe is properly connected with the object to be measured.
- Check whether there is any signal generated from the object to be measured (the trouble can be shot by the connection of the channel from which there is a signal generated with the channel in fault).
- Make the signal acquisition operation again.

3. The measured voltage amplitude value is 10 times or 1/10 of the actual value.

Look at the attenuation coefficient for the input channel and the attenuation ration of the probe, to make sure they are match (see "*How to Set the Probe Attenuation Coefficient*" on P11).

4. There is a waveform displayed, but it is not stable.

- Check whether the **Source** item in the **TRIG MODE** menu is in conformity with the signal channel used in the practical application.
- Check on the trigger **Type** item: The common signal chooses the **Edge** trigger mode for **Type** and the video signal the **Video**. If Alternate trigger is selected, both of the channel 1 and channel 2 trigger levels should be adjusted to the proper position. Only if a proper trigger mode is applied, the waveform can be displayed steadily.

5. No Display Responses to the Push-down of Run/Stop.

Check whether Normal or Signal is chosen for Polarity in the TRIG MODE menu and the trigger level exceeds the waveform range.

If it is, make the trigger level is centered in the screen or set the trigger mode as Auto. In addition, with the **Autoset** button pressed, the setting above can be completed automatically.

6. The displaying of waveform seems getting slow after increasing AVERAGE value in Acqu Mode (see "*How to Set the Sampling/Display*" on P27), or a longer duration is set in the Persist in Display (see "*Persist*" on P27).

It's normal as the Oscilloscope is working hard on many more data points.

8. Technical Specifications

Unless otherwise specified, the technical specifications applied are for the oscilloscope only, and Probes attenuation set as 10X. Only if the oscilloscope fulfills the following two conditions at first, these specification standards can be reached.

- This instrument should run for at least 30 minutes continuously under the specified operating temperature.
- If change of the operating temperature is up to or exceeds 5°C, do a "Self-calibration" procedure (see "*How to Implement Self-calibration*" on P12).

All specification standards can be fulfilled, except one(s) marked with the word "Typical".

Performance Characteristics		Instruction	
Bandwidth		SDS1022	20 MHz
		SDS1052	50 MHz
		SDS1102	100 MHz
		SDS1202	200 MHz
Channel		2 channels	
Acquisition	Mode	Normal, Peak detect, Averaging	
	Sample rate (real time)	SDS1022	100 MS/s
		SDS1052	500 MS/s
		SDS1102 SDS1202	1 GS/s
Input	Input coupling	DC, AC, Ground	
	Input impedance	1 MΩ±2%, in parallel with 20 pF±5 pF	
	Input coupling	1X, 10X, 100X, 1000X	
	Max. input voltage	400V (DC+AC, PK - PK)	
	Channel –channel isolation	50Hz: 100 : 1 10MHz: 40 : 1	
	Time delay between channel(typical)	150ps	
	Bandwidth limit	SDS1022 SDS1052	Not support
SDS1102 SDS1202		20 MHz, full bandwidth	
Horizontal System	Sampling rate range	SDS1022	0.5 S/s ~ 100 MS/s
		SDS1052	0.5 S/s ~ 500 MS/s
		SDS1102 SDS1202	0.5 S/s ~ 1 GS/s
	Interpolation	(Sinx)/x	
	Max Record length	10K	
Scanning speed (S/div)	SDS1022	5 ns/div – 1000 s/div, step by 1 – 2 - 5	

9.Appendix

Performance Characteristics		Instruction		
		SDS1052 SDS1102 SDS1202	2 ns/div – 1000 s/div, step by 1 – 2 - 5	
	Sampling rate / relay time accuracy	±100 ppm		
	Interval(ΔT) accuracy (DC - 100MHz)	Single: ±(1 interval time+100 ppm×reading+0.6 ns); Average>16: ±(1 interval time +100 ppm×reading+0.4 ns)		
Vertical system	Vertical Resolution (A/D)	8 bits (2 channels simultaneously)		
	Sensitivity	5 mV/div~5 V/div		
	Displacement	SDS1022	±2 V (5 mV/div – 100 mV/div) ±50 V (200 mV/div – 5 V/div)	
		SDS1052 SDS1102 SDS1202	±2 V (5 mV/div – 200 mV/div) ±50 V (500 mV/div – 5 V/div)	
		SDS1022	20 MHz	
	Analog bandwidth	SDS1052	50 MHz	
		SDS1102	100 MHz	
		SDS1202	200 MHz	
	Single bandwidth	Full bandwidth		
	Low Frequency	≥10 Hz (at input, AC coupling, -3 dB)		
	Rise time (at input, Typical)	SDS1022	≤ 17.5 ns	
		SDS1052	≤ 7.0 ns	
		SDS1102	≤ 3.5 ns	
		SDS1202	≤ 1.75 ns	
DC gain accuracy	±3%			
DC accuracy (average)	Delta Volts between any two averages of ≥16 waveforms acquired with the same scope setup and ambient conditions (ΔV): ±(3% reading + 0.05 div)			
Waveform inverted ON/OFF				
Measurement	Cursor	ΔV , ΔT , $\Delta T \& \Delta V$ between cursors, auto cursor		
	Automatic	Period, Frequency, Mean, PK-PK, RMS, Max, Min, Top, Base, Amplitude, Overshoot, Preshoot, Rise Time, Fall Time, +PulseWidth, -PulseWidth, +Duty Cycle, -Duty Cycle, Delay A→B ⌘ , Delay A→B ⌘ , Cycle RMS, Cursor RMS, Screen Duty, Phase, +PulseCount, -PulseCount, RiseEdgeCnt, FallEdgeCnt, Area, and Cycle Area.		
	Waveform Math	+, -, *, / ,FFT		
	Waveform storage	16 waveforms		

8. Technical Specifications

Performance Characteristics		Instruction
	Lissajous figure	Bandwidth Full bandwidth
		Phase difference ± 3 degrees
Communication port	USB 2.0 (USB storage)	
Counter	Support	

Trigger:

Performance Characteristics		Instruction
Trigger level range	Internal	± 5 div from the screen center
Trigger level Accuracy (typical)	Internal	± 0.3 div
Trigger displacement	According to Record length and time base	
Trigger Holdoff range	100 ns – 10 s	
50% level setting (typical)	Input signal frequency ≥ 50 Hz	
Edge trigger	slope	Rising, Falling
Video Trigger	Modulation	Support standard NTSC, PAL and SECAM broadcast systems
	Line number range	1-525 (NTSC) and 1-625 (PAL/SECAM)

General Technical Specifications

Display

Display Type	7" Colored LCD (Liquid Crystal Display)
Display Resolution	800 (Horizontal) \times 480 (Vertical) Pixels
Display Colors	65536 colors, TFT screen

Output of the Probe Compensator

Output Voltage (Typical)	About 5 V, with the Peak-to-Peak voltage ≥ 1 M Ω .
Frequency (Typical)	Square wave of 1 KHz

Power

Mains Voltage	100 - 240 VACRMS, 50/60 Hz, CAT II
Power Consumption	< 15 W
Fuse	2 A, T class, 250 V

8. Technical Specifications

Environment

Temperature	Working temperature: 0 °C - 40 °C Storage temperature: -20 °C - 60 °C
Relative Humidity	≤ 90%
Height	Operating: 3,000 m Non-operating: 15,000 m
Cooling Method	Natural cooling

Mechanical Specifications

Dimension	301 mm× 152 mm×70 mm (L*H*W)
Weight	About 1.1 kg

Interval Period of Adjustment:

One year is recommended for the calibration interval period.

9. Appendix

Appendix A: Enclosure

(The accessories subject to final delivery.)

Standard Accessories:



Power Cord



CD Rom



Quick Guide



USB Cable



Probe



Probe Adjust

Options:



Soft Bag

Appendix B: General Care and Cleaning

General Care

Do not store or leave the instrument where the liquid crystal display will be exposed to direct sunlight for long periods of time.

Caution: To avoid any damage to the instrument or probe, do not exposed it to any sprays, liquids, or solvents.

Cleaning

Inspect the instrument and probes as often as operating conditions require.

To clean the instrument exterior, perform the following steps:

1. Wipe the dust from the instrument and probe surface with a soft cloth. Do not make any scuffing on the transparent LCD protection screen when clean the LCD screen.

2. Disconnect power before cleaning your Oscilloscope. Clean the instrument with a wet soft cloth not dripping water. It is recommended to scrub with soft detergent or fresh water. To avoid damage to the instrument or probe, do not use any corrosive chemical cleaning agent.
-



Warning: Before power on again for operation, it is required to confirm that the instrument has already been dried completely, avoiding any electrical short circuit or bodily injury resulting from the moisture.
