



HSA Series
Handheld Spectrum Analyzer
User Manual

■HSA015

■HSA015-TG

■HSA032

■HSA032-TG

Notice: -TG models are with tracking generator

Feb. 2020 edition V1.0.0

Copyright © LILLIPUT Company. All rights reserved.

The LILLIPUT's products are under the protection of the patent rights, including ones which have already obtained the patent rights and those which are applied for. The information in this manual will replace all materials published.

The information in this manual was correct at the time of printing. However, LILLIPUT will continue to improve products and reserves the rights to change specification at any time without notice.

owon[®] is the registered trademark of the LILLIPUT Company.

Fujian LILLIPUT Optoelectronics Technology Co., Ltd.

No. 19, Heming Road

Lantian Industrial Zone, Zhangzhou 363005 P.R. China

Tel: +86-596-2130430

Fax: +86-596-2109272

Web: www.owon.com.cn

E-mail: info@owon.com.cn

General Warranty

OWON warrants that the product will be free from defects in materials and workmanship for a period of 3 years from the date of purchase of the product by the original purchaser from the OWON Company. The warranty period for accessories is 12 months. This warranty only applies to the original purchaser and is not transferable to a third party.

If the product proves defective during the warranty period, OWON will either repair the defective product without charge for parts and labour, or will provide a replacement in exchange for the defective product. Parts, modules and replacement products used by OWON for warranty work may be new or reconditioned like new. All replaced parts, modules and products become the property of OWON.

To obtain service under this warranty, the customer must notify OWON of the defect before the expiration of the warranty period. Customer shall be responsible for packaging and shipping the defective product to OWON's designated service centre, a copy of the customer's proof of purchase is also required.

This warranty shall not apply to any defect, failure or damage caused by improper use or improper or inadequate maintenance and care. OWON shall not be obligated to furnish service under this warranty a) to repair damage resulting from attempts by personnel other than OWON representatives to install, repair or service the product; b) to repair damage resulting from improper use or connection to incompatible equipment; c) to repair any damage or malfunction caused by the use of non-OWON supplies; or d) to service a product that has been modified or integrated with other products when the effect of such modification or integration increases the time or difficulty of servicing the product.

Please contact the nearest OWON's Sales and Service Offices for services.

For better after-sales service, please visit www.owon.com.cn and register the purchased product online.

Excepting the after-sales services provided in this summary or the applicable warranty statements, OWON will not offer any guarantee for maintenance definitely declared or hinted, including but not limited to the implied guarantee for marketability and special-purpose acceptability. OWON should not take any responsibilities for any indirect, special or consequent damages.

Table of contents

List of figures	iii
List of tables.....	iii
1. General Safety Requirements	1
2. Safety Terms and Symbols.....	4
3. Document Overview	5
4. Quick Start.....	6
4.1 General Inspection	6
4.2 Safety Precaution before Operation	6
4.3 First Time to Power on.....	7
4.4 Front Panel Overview	9
4.5 Top Panel Overview	10
4.6 Rear Panel Overview.....	12
4.7 User Interface Overview.....	12
4.8 Function Keys	15
4.9 Parameter Input.....	18
4.10 Build-in Help.....	19
4.11 Touchscreen Controls	20
4.12 Basic Measurement.....	24
5. Menu Interpretation	28
5.1 【FREQ】 bottom softkey.....	28
5.2 【Span】 bottom softkey.....	30
5.3 【AMPTD】 bottom softkey.....	32
5.4 【Auto】 bottom softkey.....	36
5.5 【BW】 bottom softkey	36
5.6 【Marker】 bottom softkey	37
5.7 【Trace】 hardkey	45
5.8 【Detector】 hardkey	47
5.9 【Display】 hardkey	49
5.10 【Sweep】 hardkey.....	51
5.11 【Trig】 hardkey.....	52
5.12 【Source】 hardkey.....	53
5.13 【Demod】 hardkey	55
5.14 【System】 hardkey.....	56
5.15 【File】 hardkey.....	65
5.16 【Measure】 hardkey.....	67
6. Specification	71

7. Troubleshooting	78
8. Appendix.....	79
Appendix A: Enclosure	79
Appendix B: General Care and Cleaning	80
Appendix C: USB Disk Requirements	80
Appendix D: PC Software Requirements	80

List of figures

Figure 4-1 Front panel..... 9
Figure 4-2 Top panel..... 10
Figure 4-3 Rear panel..... 12
Figure 4-4 User interface 13
Figure 4-5 Function softkeys 15
Figure 4-6 Shift key and function hardkeys..... 17
Figure 4-7 Numeric keypad 18
Figure 4-8 The rotary knob 19
Figure 4-9 Arrow keys 19
Figure 4-10 Full Span..... 25
Figure 4-11 Set frequency span..... 26
Figure 4-12 Set reference level..... 27

List of tables

Table 4-1 AC-DC adapter requirement..... 7
Table 5-1 Detector type comparison 47
Table 5-2 [Factory] Settings..... 60

1. General Safety Requirements

Before use, please read the following safety precautions to avoid any possible bodily injury and to prevent this product or any other connected products from damage. To avoid any contingent danger, ensure this product is only used within the ranges specified.

- **Use Proper Power Cord.** Use only the power cord supplied with the product and certified to use in your country.
- **Power Grounded.** The main plug should be inserted in a power socket outlet only if provided with a protective earth contact.
- **Check all Terminal Ratings.** To avoid fire or shock hazard, check all ratings and markings on this product. Refer to the user manual for more information about ratings before connecting to the instrument.
- **Use Proper Overvoltage Protection.** Make sure that no overvoltage (such as that caused by a thunderstorm) can reach the product, or else the operator might expose to danger of electrical shock.
- **Do not operate without covers.** Do not operate the instrument with covers or panels removed.
- **Avoid exposed circuit.** Be careful when working on exposed circuitry to avoid risk of electric shock or other injury.
- **Do not operate if any damage.** If you suspect damage to the instrument, have it inspected by qualified service personnel before further use. Any maintenance, adjustment or replacement especially to circuits or accessories must be performed by qualified service personnel.
- **Use your instrument in a well-ventilated area.** Make sure the instrument installed with proper ventilation.
- **Do not operate in damp conditions.** In order to avoid short circuiting to the interior of the device or electric shock, please

do not operate in a humid environment.

- **Do not operate in an explosive atmosphere.** In order to avoid damages to the device or personal injuries, it is important to operate the device away from an explosive atmosphere.
- **Keep product surfaces clean and dry.** To avoid the influence of dust or moisture in air, please keep the surface of device clean and dry.
- **Electrostatic Prevention.** Operate the instrument in an electrostatic discharge protective environment to avoid damage induced by static discharges. Always ground both the internal and external conductors of cables to release static before making connections.
- **Protect the Input Terminals of Instrument.** Do not bend or hit the input terminals and the connected devices, (such as filter, attenuator, etc.) as such stress may cause damages to devices and the instrument. Do not mix the use of 50Ω and 75Ω connectors and/or cables.
- **Do Not Overload the Input.** To avoid damaging the instrument, the signals at input terminal must be less than 50V DC voltage components and 30 dBm (1 W) AC (RF) components.
- **Appropriate Use of Power Meter.** If you are not sure of the characteristics of signal under measure, follow these recommendations to ensure safe operations: if a RF power meter is available, use it to measure the power level of this signal first; or add a rated external attenuator between signal cable and input terminal of the instrument. Maximum attenuation, reference level and maximum span frequency should be selected, to make the signals displayed within the screen.
- **Know About the Specification Conditions of the Instrument.** For maximum performance of the instrument, use the analyzer under specified conditions.

- **Handling Safety.** Please handle with care during transportation to avoid damages to buttons, knob, interfaces and other parts on the panels.

2. Safety Terms and Symbols

Safety Terms

Terms in this manual (The following terms may appear in this manual):



WARNING
Warning indicates conditions or practices that could result in injury or loss of life.



CAUTION
Caution indicates the conditions or practices that could result in damage to this product or other property.

Terms on the product (The following terms may appear on this product):

DANGER Indicates an immediate hazard or injury possibility.

WARNING Indicates a possible hazard or injury.

CAUTION Indicates potential damage to the instrument or other property.

Safety Symbols

Symbols on the product (The following symbols may appear on the product):



Refer to Manual



Conforms to European Union directives



This product complies with the WEEE Directive (2002/96/EC) marking equipment. The affixed product label indicates that you must not discard this electrical/electronic product in domestic household waste.

3. Document Overview

● Quick Start

This chapter states the matters need to attention before first power on, how to power on at first time, introduces spectrum analyzer's front/rear panel and user interface, explains how to use the instrument with a measurement example demonstration.

● Menu Interpretation

This chapter offers spectrum analyzer's front panel menu and button interpretation.

● Specification

This chapter lists spectrum analyzer's specification parameter.

● Trouble Shooting

This chapter helps to implement the troubleshooting and deal with after sale repair.

● Appendix

This chapter introduces accessories of spectrum analyzer and how to maintain device.

Convention on button and menu key format:

Button character + bold bracket, e.g. **【FREQ】** stands for FREQ bottom softkey.

Submenu words+bracket, e.g.[Center frequency] stands for **【FREQ】** function's center frequency item, that is common called softkey menu item.

Related document:

Related documents including: Quick guide, User manual, programme guide and etc.

4. Quick Start

This chapter states the matters need to attention before first power on, and how to power on at first time, introduces spectrum analyzer's front/top panel and user interface, explains how to use the instrument with a measurement example demonstration.

4.1 General Inspection

When you receive your new instrument, it is recommended that you check the instrument following these steps:

1. Check for transportation damage.

If it is found that the packaging carton or the foamed plastic protection cushion has suffered serious damage, do not throw it away until the complete device and its accessories have been electrically and mechanically checked.

2. Check the Accessories

The supplied accessories are described in the "*Appendix A: Enclosure*" of this Manual. Please ensure that all the listed accessories are present and undamaged, if any problems are found please contact your distributor or OWON's local office.

3. Check the Complete Instrument

If there is any physical damage, operational fault, or performance issue please contact your distributor or OWON's local office. If there is any damage to the instrument please ensure you keep the original packaging. Ideally you should always keep the original packaging if the instrument must be returned for repair.

4.2 Safety Precaution before Operation

4.2.1 Power Supply Requirements

The analyzer allows the use of either an internal lithium battery pack, or AC-DC adapter shipped with the analyzer for its power supply.

The lithium battery is 7.4V, 9100 mAh.

The table below lists the requirement of the AC-DC adapter.

Table 4-1 AC-DC adapter requirement

AC-DC adapter parameter	Compatible range
Input Voltage	100 V - 240 VAC, 50/60 Hz
Output Voltage	12 - 15 VDC
Max. Power	45 W

4.2.2 Electro-static Discharge (ESD) Protection

ESD is an issue often ignored by users. Damage from ESD on the instrument is unlikely to occur immediately but will significantly reduce the reliability of it. Therefore, ESD precautions should be implemented in the work environment, and applied daily.

Generally, there are two steps to manage ESD protection:

- 1) Conductive table mat to connect hands via wrist bands
- 2) Conductive ground mat to connect feet via ankle straps

Implement both protection methods will provide a good level of anti-static protection. If used alone, the protection will not be as reliable. To ensure user's safety, anti-static components should offer at least 1M Ω isolation resistance.



WARNING

The above ESD protections measures cannot be used when working with over 500V!

Make good use of anti-static technology to protect components from damage:

- 1) Quickly ground the internal and external conductor of the coaxial cable before it is connected to the spectrum analyzer.
- 2) Staff must wear anti-static gloves before touching the connector cord or doing any assemble work.
- 3) Assure all the instruments are grounded properly to avoid static storage.

4.3 First Time to Power on

Note: Keep the air vents always clear of obstructions for proper

ventilation and cooling of the instrument.



CAUTION

Use only the original AC-DC adapter or originally supplied battery for the power source.

The maximum RF input level of an average continuous power is 30 dBm (or 50 VDC signal input). Avoid connecting a signal into the analyzer that exceeds the maximum level.

- 1) Press the power switch  on the front panel.
- 2) Self-initialization takes about 30 seconds, after the boot screen the spectrum analyzer will default to the scanning curve.
- 3) After power on, let the spectrum analyzer warm up for 30 minutes for stabilization to obtain the most accurate results.

4.4 Front Panel Overview

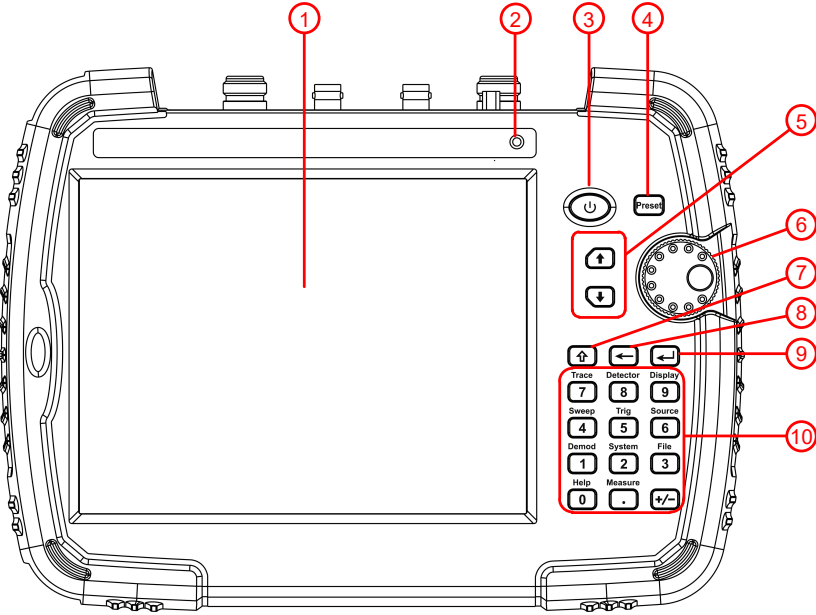

Figure 4-1 Front panel

NO.	Description
①	LCD touchscreen. The touchscreen can be specified in 【System】 → [Setting▶] → [Control▶] → [TouchControl▶].
②	Light Sensor: Adjusts the screen backlight according to the environmental light. This state can be specified in 【Display】 → [ScreenSetting▶] → [Brightness <u>A</u> uto].
③	Power key: Long push to turn on the analyzer, push to turn on/off the LCD display, long push to turn off the analyzer.
④	Preset key: Resets the analyzer to a known state. This state can be specified in 【System】 → [PowerOn/Preset▶] → [Preset▶].
⑤	Arrow keys
⑥	Rotary knob

⑦	Shift key: Press the Shift key to active it, the light is on. When the Shift key is active, pressing a number key will execute the upper function. Long press the Shift key to active it persistently. To switch to the brief active status, short press the Shift key.
⑧	Backspace key: Deletes the last character from input.
⑨	Enter key: Confirms a parameter selection or configuration.
⑩	Function / numeric keypad

4.5 Top Panel Overview

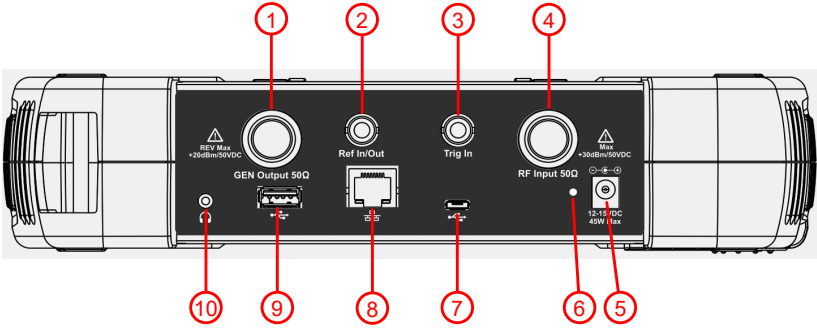



Figure 4-2 Top panel

NO.	Name	Description
①	GEN Output connector (50 Ω)	N type female connector. The output for the built-in tracking generator.
②	10MHz IN/OUT	BNC, female connector. The BNC input or output of the 10 MHz reference clock.
③	EXT Trig In connector	BNC, female connector. Connects to an external TTL signal. The TTL signal is used to trigger the analyzer’s internal sweep.

④	RF Input connector (50 Ω)	<p>N type female connector. Connector for RF input.</p> <p> CAUTION</p> <p>Input voltage at RF input port must not be higher than 50 V DC to avoid damage to the attenuator and input mixer tracking generator.</p> <p>When input attenuator is higher than 10 dB, the RF port input signal must be less than +30 dBm.</p>
⑤	External power connector	Provides input for the DC power source via an AC-DC adapter.
⑥	LED indicator	Green light when external DC power is connected. Red light when the battery is charging. Blinking light when charge suspend or battery absent.
⑦	USB Device interface	MICRO-USB type. Connects to a PC. This USB interface supports PictBridge printer and remote-control connection.
⑧	LAN interface	Through this interface, the analyzer can be connected to your local network for remote control.
⑨	USB Host interface	Type A. Connects to a USB memory stick.
⑩	Headphone jack	Connects to a headphone.

4.6 Rear Panel Overview

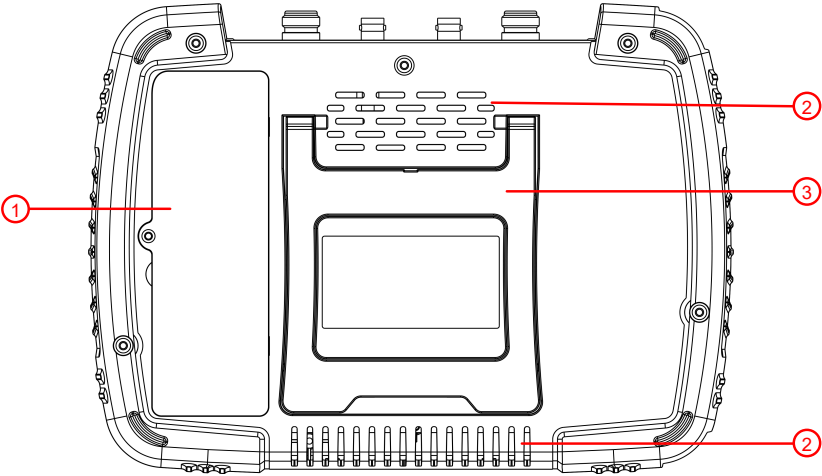

Figure 4-3 Rear panel

NO.	Name
①	Battery compartment
②	Air vents
③	Tilt stand

4.7 User Interface Overview

Figure below illustrates the user interface, with touch screen menu keys, top bar, and measurement settings and results around the graph area.

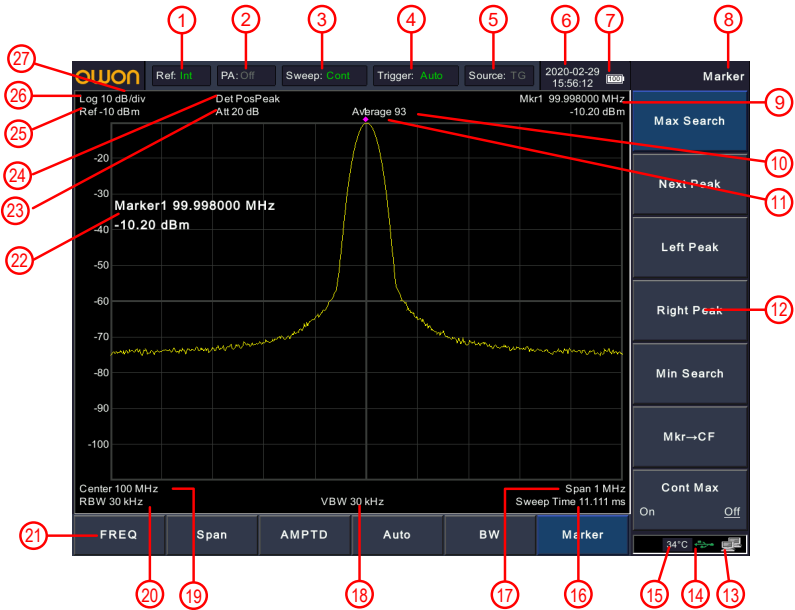

Figure 4-4 User interface

NO.	Name	Description	Related Key
①	Reference frequency	Set the reference frequency as Int (internal) or Ext (external) input	FREQ → [Freq Ref]
②	Preamplifier	Turn on/off the preamplifier	AMPTD → [Preamplifier]
③	Sweep status	Set the sweep status to Single or Cont (continuous)	【Sweep】 → [Sweep Single] or [Sweep Cont]
④	Trigger type	Set the trigger type to Auto , Video , Pos (external positive edge), Neg (external negative edge)	【Trig】
⑤	Source	Show the source type as CW (Continuous Wave) or TG (Tracking Generator), press to turn on/off the source output	【Source】 → [Output] and [Source GEN]

⑥	Date/time	Display system date and time	【System】 → [Setting] → [Date/Time]
⑦	Battery charge indicator	Show the battery level	
⑧	Menu title	Function of current menu belongs to	
⑨	Marker information	Display frequency and amplitude of current marker	Marker
⑩	Trace average number	Continuously get average of the trace to smooth it.	BW → [Average]
⑪	Marker	Display current activated marker	Marker
⑫	Submenu softkeys	Menu items of current function, can be hidden	【Display】 → [UI Setting▶] →[Menu Hiding]
⑬	LAN access sign	LAN access sign	
⑭	USB storage device status	The USB icon changes to green when USB storage device is inserted.	
⑮	Temperature or ANT	Display device internal temperature.	
⑯	Sweep Time	System sweep time	【Sweep】 → [Sweep Time]
⑰	Frequency span or stop frequency	Display span width or stop frequency	Span →[Span] or FREQ →[Stop Freq]
⑱	Video bandwidth	Display video bandwidth	BW → [VBW]
⑲	Center frequency or start frequency	Display center frequency or start frequency	FREQ → [Center Freq] or [Start Freq]
⑳	Resolution bandwidth	Display resolution bandwidth	BW →[RBW]

⑳	Function softkeys	Press to active the submenu on the right	
㉑	Active parameter setting	Use the number keypad, knob, and arrow keys to set the value.	
㉒	Attenuation	Display input attenuation setting	AMPTD → [Attenuation]
㉓	Detector type	Display detector type	【Detector】
㉔	Reference level	Reference level	AMPTD → [Ref Level]
㉕	Amplitude Scale Type	Log (logarithmic) or Line (linear)	AMPTD → [Scale Type]
㉖	Amplitude Scale	Display amplitude scale	AMPTD → [Scale/Div]

4.8 Function Keys

There are 6 function softkeys on the interface screen and 11 function hardkeys on the front panel.

4.8.1 Function Softkeys

There are 6 function softkeys horizontally arranged along the bottom of the interface screen. Press one of the function softkeys to show the submenu along the right side of the display.



Figure 4-5 Function softkeys

Softkeys	Description
FREQ	Activates the center-frequency function, and accesses the frequency function menu.
Span	Activates the frequency sweep span function, and set Full Span\Zero Span>Last Span.
AMPTD	Activates the reference level function, and accesses the amplitude softkeys, with which you set functions that affect data on the vertical axis.

Auto	Searches the signal automatically within the full frequency range.	
BW	Activates the RBW (resolution bandwidth) function, and accesses the softkeys that control the bandwidth functions and averaging.	
Marker	[Marker]	Accesses the marker control keys that select the type and number of markers and turns them on and off.
	[MarkerFctn]	Accesses the menu of special functions, such as N dB bandwidth measure, marker noise, and frequency counting.
	[Marker→]	Accesses the marker function softkeys that allow you to set other system parameters based on the current marker value.
	[Peak]	Places a marker on the highest peak, and accesses the Peak functions menu.

4.8.2 Function Hardkeys

Pressing the  **Shift** key followed by a number key executes the function that is indicated in blue above the number key.

Shift key:

- Press the Shift key to active it, the light is on.
- When the Shift key is active, pressing a number key will execute the upper function.
- Long press the Shift key to active it persistently.
- To switch to the brief active status, short press the Shift key.



Figure 4-6 Shift key and function hardkeys

Hardkeys	Description
【Trace】	Accesses the softkeys that allow you to store and manipulate trace information.
【Detector】	Accesses the softkeys that allow you to configure detector functions.
【Display】	Accesses the softkeys that allow you to control what is displayed on the analyzer, including the display line, graticule and label.
【Sweep】	Accesses the softkeys that allow you to set the sweep time, select the sweep mode of the analyzer.
【Trig】	Accesses the softkeys that allow you to select the trigger mode of the analyzer.
【Source】	Accesses the softkeys that allow you to set the tracking generator.
【Demod】	Accesses the softkeys that allow you to set the demodulation.
【System】	Sets the system parameters. Accesses the calibration menu. Set the print parameters. Save and recall screen pixmap, trace data, or user state.
【File】	Accesses the softkeys that allow you to configure the file system of the analyzer.

【Help】	Press the Help key to activate the help system. Press the Help key again to exit.
【Measure】	Accesses the softkeys that let you make transmitter power measurements such as ACPR (adjacent channel power), channel power, and OBW (occupied bandwidth), etc. Sets the parameters for the selected measurement function in [Meas Setup▶].

4.9 Parameter Input

The active parameter value can be entered using the numeric keypad, knob, and arrow keys.

4.9.1 Numeric keypad





Enters a specific value, the submenu typically shows the selectable units. Press the desired unit or press  Enter key to complete the entry.



Figure 4-7 Numeric keypad

1. Number keys
Numbers 0-9 are available to be used.
2.  Decimal point
A decimal point "." will be inserted at the cursor position when this key is pressed.
3.  Sign key
Sign key "+/-" is to toggle the sign of a parameter. When pressed the first time, a "-" will be inserted and changed into "+" following the second press.

4.  Backspace key
- (1) During the process of parameter editing, this key will delete the characters on the left side of the cursor.
 - (2) While in the process of file name editing, pressing this key will delete characters that have been entered.
5.  Enter key
- When pressed, the system will complete the input process and insert a default measurement unit for the parameter automatically.

4.9.2 Rotary knob

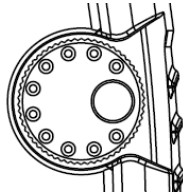

Figure 4-8 The rotary knob

The knob function:

During parameter editing, turn the knob clockwise to increase, or counterclockwise to decrease the parameter values at specified steps.

4.9.3 Arrow keys



Figure 4-9 Arrow keys

The arrow keys have following functions:

- 1) Increase or decrease the parameter value at specific steps while editing a parameter.
Note: Press **FREQ**→**[CF Step]** to set the center frequency step.
- 2) Move the cursor through the directory tree in the **【File】** function.

4.10 Build-in Help

The built-in help provides information that refers to every function

key and menu key on the front panel. Users can view this help information if required.

1.How to acquire built-in help

Press  **Shift** key, then **【Help】** key; a prompt about how to obtain help information will be shown

2.Page up and down

If there is more than one page of information, you can read the complete information by using the arrow keys or dragging via touch screen.

3.Close the current help information

Press  **Shift** key, then **【Help】** key again to close help.

4.Acquire the softkey help

A message about how to obtain help information will be shown, press the softkeys to get the corresponding help.

5.Acquire the help information of any function hardkey

A message about how to obtain help information will be shown, press  **Shift** key, then any function hardkey to get the corresponding help.

4.11 Touchscreen Controls

The LCD is touchable, you can control the analyzer by different gestures.

The touchscreen can be specified in **【System】** → [Setting▶] → [Control▶] → [TouchControl▶]. You can turn on/off the touch control in this submenu.

The instruction of touchscreen controls is as below. You can also use the buttons / knobs enclosed in brackets to do the same thing.

- Click the label to toggle between options on the top bar. See User Interface Overview for details on page 12.

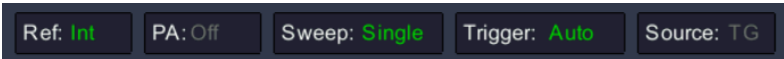

- Select a menu softkey:** Touch the menu softkeys in the bottom, or in the right.



- **Switch menu items:** If there are options that can be switched in the menu, you can repeatedly touch the area of the menu item to switch.



Press repeatedly to switch the options

- **Scroll the list:** If there is a scroll bar in the file system window, you can swipe up and down to scroll the list.
- **Capture the screen (【System】 → [Save/Recall▶] → [Screen Pixmap▶]):** Double-tap in the display area to quickly capture a PNG image of the current screen display. If a USB device is inserted, the image will be saved to USB device, otherwise the local memory. A file name is automatically created using the current date and time stamp.



- **Move the active marker to the desired frequency (Marker → [Marker ▶] → turn the knob):** When a marker is active, single-tap in the display area (at any level) to quickly move the marker to

the desired frequency.

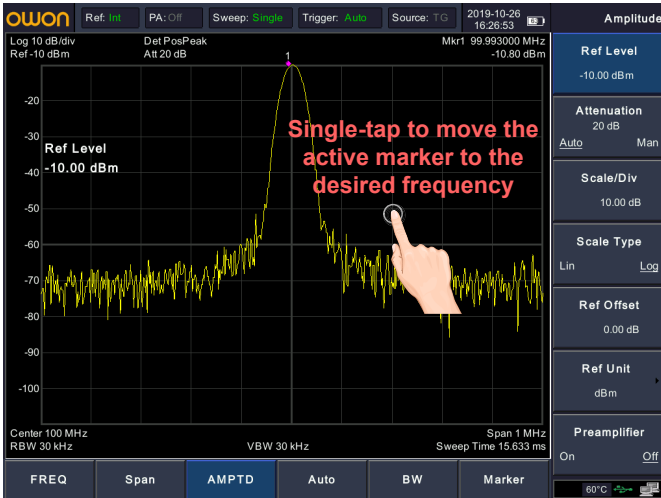

- Set the reference level (AMPTD → [Ref Level]): Swipe up or down in the display area.



- Set the center or start frequency (FREQ → [Center Freq] or [Start Freq]): Swipe left or right in the display area.

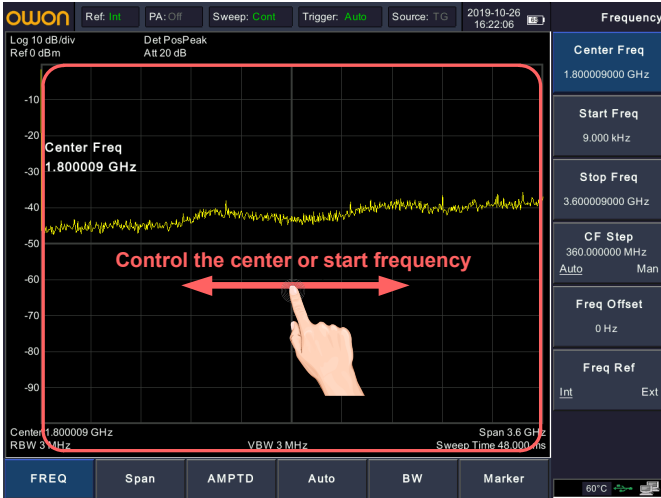

- **Set the Span (Span → [Span]):** In the display area, pinch and spread horizontally to change the span.
- **Set the RBW (BW → [RBW]):** When **BW** → [RBW] softkey is selected, pinch and spread horizontally to change the RBW.
- **Set the VBW (BW → [VBW]):** When **BW** → [VBW] softkey is selected, pinch and spread horizontally to change the VBW.

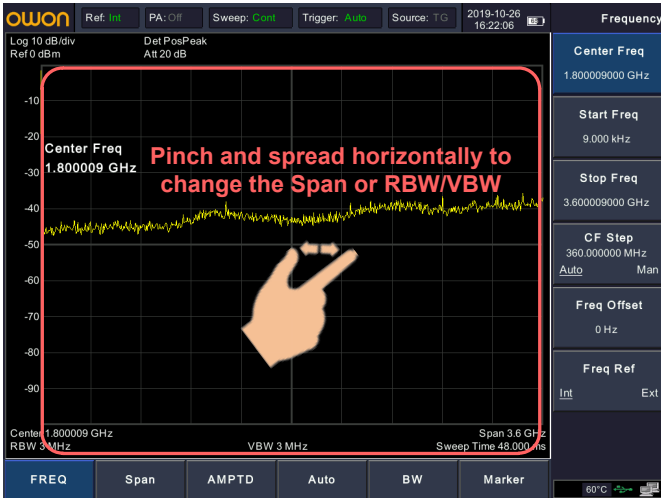

- **Set the Scale/Div (AMPTD → [Scale/Div]):** In the display area, pinch and spread vertically to change the Scale/Div.



4.12 Basic Measurement

Basic measurements include, input signal frequency and amplitude display, marked by a frequency marker.

Follow these four simple steps below to implement input signal measurement.

- a) Setting center frequency;
- b) Setting span and resolution bandwidth;
- c) Activate marker;
- d) Setting amplitude.

For example, to measure a 100 MHz, -10 dBm signal, you must turn on the spectrum analyzer and ensure it is warmed up for 30 minutes to ensure measurement accuracy.

1. Equipment connection

Connect the output terminal of signal generator to the **RF Input 50Ω** connector on the top of the spectrum analyzer. Set the parameters as follows:

Frequency	100 MHz
Amplitude	-10 dBm

2. Setting parameters

- 1) Press **【Preset】** on the front panel to restore the analyzer to its

factory-defined state. The Spectrum analyzer will display the spectrum from 9kHz to the maximum span width. The signal generated will display as a vertical line at 100MHz. Refer to Figure 4-10.

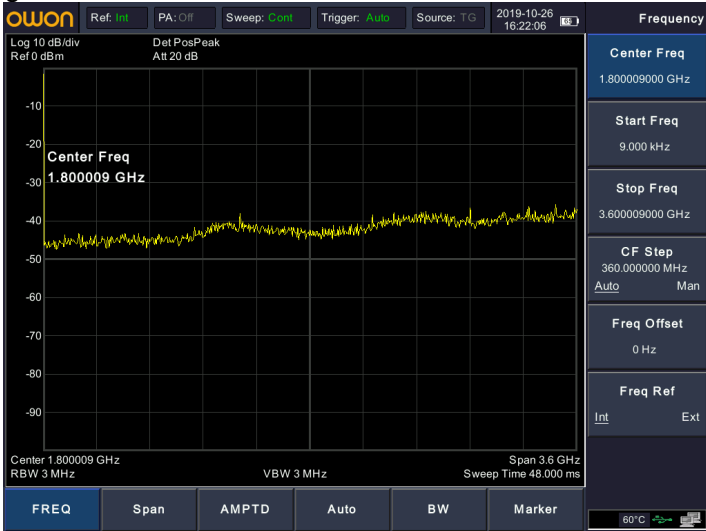

Figure 4-10 Full Span

To clearly observe the signal, reduce the frequency span to 1 MHz and set the center frequency to 100MHz.

2) Setting center frequency

Press **FREQ** softkey on the bottom, select [**Center Freq**] on the right submenu. Input "**100**" and select the unit as **MHz** on the right softkeys. The number keys can be used to set the exact value, the knob and arrow keys can also be used to set the center frequency.

3) Setting frequency span

Press **Span** softkey, input "**1**" and press **MHz** as its unit.

Press **BW** softkey, set [**RBW**] to **Man**, and input "**30**" and press **kHz** as its unit.

Press **Shift** key followed by the [**Detector**] key, set the detection type to **Pos Peak**.

Figure 4-11 shows the signal at a higher resolution.

Please note that resolution bandwidth, video bandwidth and

frequency span are self-adapted. They adjust to certain values according to frequency span. Sweep time can be self-adapted too.

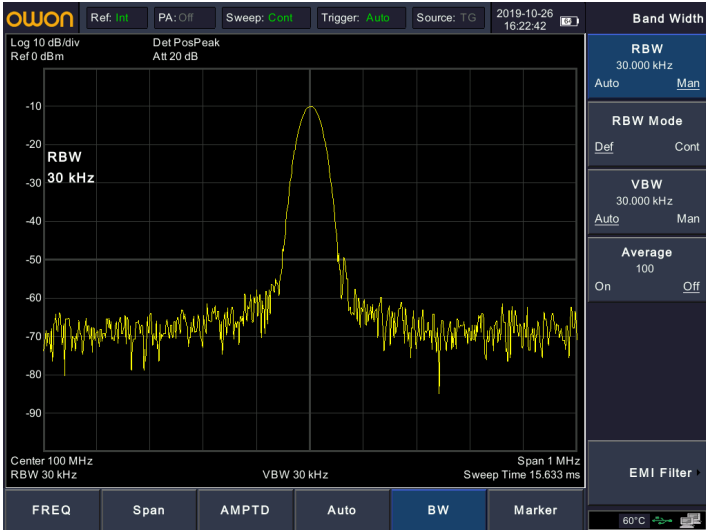

Figure 4-11 Set frequency span

4) Activate marker

Press **Marker** softkey on the bottom, select [**Marker ▶**] on the right submenu. Press the softkey to select [**Marker 1 2 3 4 5**], select Marker 1, the marker is located at horizontal center by default, that is the signal peak point or its neighbor.

Press **Marker** softkey on the bottom, select [**Peak ▶**] on the right submenu. Select [**Max Search**]. Frequency and amplitude values are read by the marker and shown on the top right of the display area.

5) Setting amplitude

The reference level will be shown at the top of the display grid. To get a better dynamic range, the real signal peak point should be located at or near the top of display grid (reference level).

The reference level is also the maximum value on Y axis. Here we reduce to 20dB reference level to increase the dynamic range.

Press **AMPTD** softkey on the bottom, and the [**Ref Level**] softkey on the right will be activated. The reference level can be

input at the top left of the display grid. Input "-10" using the numeric keypad and set the unit to **dBm**. The reference level is set at -10 dBm, which is the signal peak value near the top of the grid. The balance between the signal peak value and noise is dynamic range.

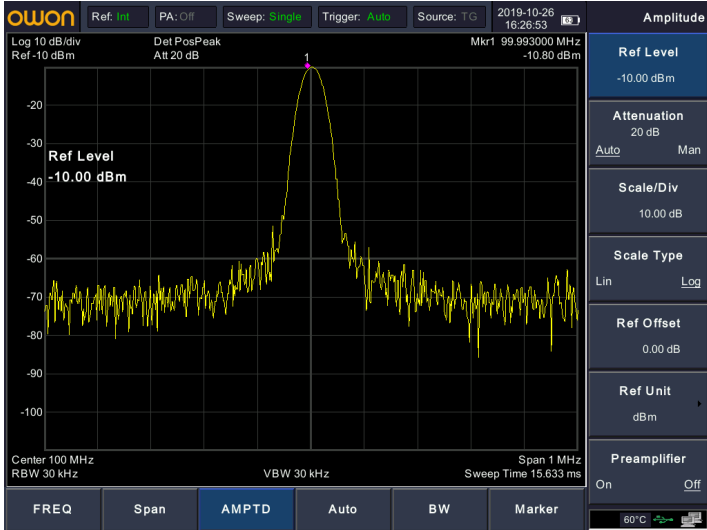

Figure 4-12 Set reference level

5. Menu Interpretation

This chapter provides you with the information on the function softkeys and hardkeys of the spectrum analyzer.

5.1 【FREQ】 bottom softkey

Key access: **[FREQ]** softkey at the bottom of the screen

The frequency range of a channel can be expressed by either of two groups of parameters: Start Frequency and Stop Frequency; or Center Frequency and Span. If any such parameter is changed, the others would be adjusted automatically in order to ensure the coupling relationship among them

$$f_{center} = (f_{stop} + f_{start}) / 2 \tag{5-1}$$

$$f_{span} = f_{stop} - f_{start} \tag{5-2}$$

f_{center} , f_{stop} , f_{start} and f_{span} denotes the center frequency, the stop frequency, the start frequency and the span respectively.

5.1.1 [Center Freq]

Sets the center frequency of the sweep. When pressed, the frequency mode is switched to Center Freq and Span in order to enter the desired parameter data.

Key Points:

- The start and stop frequencies vary with the center frequency when the span is constant.
- Changing the center frequency horizontally shifts the current sweep channel and the adjustment is limited by the specified frequency range.
- In Zero Span mode, the start frequency, stop frequency and center frequency are always equal. If one is changed the others are updated to match.
- You can modify this parameter using the numeric keys, knob, or direction keys.

5.1.2 [Start Freq]

Sets the start frequency of the sweep. When pressed, the frequency mode is switched to Start Freq and Stop Freq in order to enter the desired parameter data.

Key Points:

- The span and center frequency are changed automatically according to the start frequency. The change of the span would have influence on other system parameters. For more details, please refer to "Span".
- In Zero Span mode, the start frequency, stop frequency and center frequency are always equal. If one is changed the others are updated to match.
- You can modify this parameter using the numeric keys, knob, or direction keys.
- If start freq is larger than stop freq when setting, then stop freq will increase automatically to the same value of start freq.

5.1.3 [Stop Freq]

Sets the stop frequency of the sweep. When pressed, the frequency mode is switched to Start Freq and Stop Freq in order to enter the desired parameter data.

Key Points:

- Modifying the stop frequency changes the span and center frequency, and the change of span influences other system parameters, see "Span".
- You can modify this parameter using the numeric keys, knob, or direction keys.
- If stop freq is larger than start freq when setting, then start freq will decrease automatically to the same value of stop freq.

5.1.4 [CF Step Auto Manual]

Sets the step of center frequency. Changing the center frequency in a fixed step continuously switches the channel to be measured.

Key Points:

- The frequency step type could be "Manual" or "Auto". In Auto mode, the CF step is 1/10 of span if it is in Non-zero span mode or equals 25% of RBW while in Zero span mode; in Manual mode, you can set the step using the numeric, step keys or knob.

Then activate **【Center Frequency】** , press step, center frequency will change as setting step.

- After you set an appropriate frequency step and select center frequency, you can use using up and down direction keys to switch between measurement channels in a specified step in order to sweep the adjacent channels manually.
- You can modify this parameter using the numeric keys, knob, or direction keys.

Frequency step lends itself to detect the harmonic waves and bandwidths that are beyond the current span.
For example, for order of harmonic of a 300 MHz signal, you can use set both the center frequency and frequency step to 300 MHz, and press the up direction key continuously to increase the center frequency to 600MHz, that is secondary harmonic. Press frequency steps to increase center frequency by 300MHz, which reaches 900MHz. [Frequency Step Auto Manual] shows the auto or manual mode to setting the steps. When step is under manual mode, press [Frequency Step Auto Manual] to return to auto mode.

5.1.5 [Freq Offset]

You can set a frequency offset to displayed frequency value, including freq marker value. This movement won't influence sweep frequency range.

While this function activated (frequency offset isn't 0), you can modify this parameter using the numeric keys, knob or direction keys.

5.1.6 [Freq Ref Int Ext]

Set the reference frequency as internal or external input, this is regarded as whole device reference.

5.2 **【Span】** bottom softkey

Key access: **[Span]** softkey at the bottom of the screen

Set the spectrum analyzer to span mode. When press **【Span】** softkey, [Span], [Full Span], [Zero Span] and [Last Span] submenu will be available along the right side of the display. You can modify span using the numeric keys, knob or direction keys. Use numeric key or [Zero Span] to clear span.

5.2.1 [Span]

Sets the frequency range of the sweep. When pressed, the frequency mode is switched to Center Freq/Span.

Key points:

- The start and stop frequencies are changed with the span automatically.
- In manual span mode, the span can be set down to 0 Hz, that is zero span mode. And up to the full span described in "Specification". When it is set to the maximum span, it enters full span mode.
- Modifying the span in non-zero span mode may cause an automatic change in both CF step and RBW if they were in Auto mode, and the change of RBW may influence VBW (in Auto VBW mode).
- In non-zero span mode, variation in the span, RBW or VBW would cause a change in sweep time.
- You can modify this parameter using the numeric keys, knob, or direction keys.

5.2.2 [Full Span]

Sets the spectrum analyzer to center frequency/sweep mode, and span of the analyzer to the maximum.

5.2.3 [Zero Span]

Sets the span of the analyzer to 0 Hz. Both the start and stop frequencies will equal the center frequency and the horizontal axis will denote time. The analyzer here is measuring the time domain characteristics of amplitude, located at the corresponding frequency point. This will help to observe the signal (especially for

modulated signal) at time domain.

5.2.4 [Last Span]

Changes the span to the previous span setting.

5.3 【AMPTD】 bottom softkey

Key access: [AMPTD] softkey at the bottom of the screen

Sets the amplitude parameters of the analyzer. Through these parameters, signals under measurement can be displayed at an optimal view with minimum error. The amplitude submenu includes [Ref Level], [Attenuation Auto Manual], [Scale/Div], [Scale Type Lin Log], [Ref Offset], [Ref Unit], and [Preamplifier On Off].

5.3.1 [Ref Level]

Activate reference level function and sets the maximum power or voltage for display window.

Key points:

- This value is affected by a combination of maximum mixing level, input attenuation, and preamplifier. When you adjust it, the input attenuation is adjusted under a constant max mixing level, meeting:

$$L_{Ref} - a_{RF} + a_{PA} \leq L_{mix} \quad (5-3)$$

- L_{Ref} , a_{RF} , a_{PA} and L_{mix} denotes the reference level, the input attenuation, the preamplifier, and the max mixing level, respectively.
- You can modify this parameter using the numeric keys, knob, or direction keys.

Reference level located at the top of axis grid. Measurement near the reference level would gain better accuracy, but input signal amplitude should not exceed the reference level; if it exceeds, the signal will be compressed and distorted, result in wrong measurement. Analyzer's input attenuation is related with reference level, it can self-adjust to avoid signal compression. Minimum reference level is -80dBm at Log scale under 0dB attenuation.

5.3.2 [Attenuation Auto Man]

Sets the front attenuator of the RF input in order to permit big signals (or small signals) to pass from the mixer with low distortion (or low noise). It only works under internal mixer mode to adjust input attenuator insider analyzer. In Auto mode, input attenuator is related with reference level.

Key points:

- When the preamplifier is On, the input attenuation could be set up to 40 dB. You can adjust the reference level to ensure that the specified parameters meet the requirement.
- Modifying the reference level may cause an automatic change in attenuation value; But the change of attenuation value won't influence reference level.
- You can modify this parameter using the numeric keys, knob, or direction keys.

Attenuator adjustment is to make the maximum signal amplitude pass from mixer less than or equal to -10dBm. E.g. if the reference level is +12dBm, the attenuator value is 22dB, then the input level in mixer is -18dBm ($12-22-8=-18$), its mainly purpose is to avoid signal compression. Switch [Input Atten Auto Manual] to manual mode, adjust the attenuator manually. The highlight under auto or manual stands for auto coupling and manual coupling. When attenuator is under manual mode, press [Input Atten Auto Manual] will match the attenuator and reference level again.

Note: Maximum input signal amplitude of input attenuator (10dB input attenuation at least) is +27dBm, higher power signal will damage input attenuator or mixer.

5.3.3 [Scale/Div]

Sets the logarithmic units per vertical grid division on the display. Select 1,2,4 or 10dB log amplitude scale. It's 10dB/div by default. Every activated marker is with dB as unit, difference between two markers is treated as marker difference under dB unit.

Key points:

- By changing the scale, the displayed amplitude range is adjusted.
- The amplitude that can be displayed is from reference level minus 10 times the current scale value to the reference level.
- You can modify this parameter using the numeric keys, knob, or direction keys.

5.3.4 [Scale Type Lin Log]

Sets the Scale Type of Y-axis to Lin or Log, the default is Log. It only works under internal mixer mode. In general, select mV as Lin amplitude scale unit. Of course there would be other units for select.

Key points:

- In Log scale type: The Y-axis denotes the logarithmic coordinates, the value shown at top of the grid is the reference level, and the grid size is equal to the scale value. The unit of Y-axis will be automatically switched into the default "dBm" when the scale type is changed from Lin to Log.
- In Lin scale type: The Y-axis denotes the linear coordinates, the value shown at the top of the grid is the reference level and the bottom of the grid shows 0 V. The grid size is 10% of the Reference level and the Scale/Div is invalid. The unit of Y-axis will be automatically switched into the default "mV" when the scale type is changed from Log to Lin.
- Other than as mentioned above, the unit of Y-axis is independent of the Scale Type.

5.3.5 [Ref Offset]

Assigns an offset to the reference level to attempt to compensate

for gains or losses generated between the device under measurement and the analyzer.

Key points:

- The changing of this value changes both the readout of the reference level and the amplitude readout of the marker, but will not impact the position of the curve on the screen.
- You can modify this parameter using the numeric keys.
- This offset use dB as absolute unit, will not change with selected scale and unit.

5.3.6 [Ref Unit▶]

Sets the unit of the Y-axis to [dBm], [dBμW], [dBpW], [dBmV], [dBμV], [W] or [V].

Key points:

- 1) **[dBm]**
Choose decibel equals to 1mW as amplitude unit.
- 2) **[dBμW]**
Choose decibel equals to 1μW as amplitude unit.
- 3) **[dBpW]**
Choose decibel equals to 1pW as amplitude unit.
- 4) **[dBmV]**
Choose decibel equals to 1mV as amplitude unit.
- 5) **[dBμV]**
Choose decibel equals to 1μV as amplitude unit.
- 6) **[W]**
Choose Watts as amplitude unit.
- 7) **[V]**
Choose Voltage as amplitude unit.

5.3.7 [Preamplifier On Off]

Sets the status of preamplifier located at the front of the RF signal path. Turning on the preamplifier reduces the displayed average noise level in order to distinguish small signals from the noise when working with small signals.

5.4 【Auto】 bottom softkey

Key access: [Auto] softkey at the bottom of the screen

Searches for signals automatically throughout the full frequency range, adjusts the frequency and amplitude to their optimum and realizes one-key signal search and auto setting of parameters.

Key points: some parameters such as reference level, scale, and input attenuation may be changed during the auto tune.

5.5 【BW】 bottom softkey

Key access: [BW] softkey at the bottom of the screen

Sets the RBW (Resolution Bandwidth) and VBW (Video Bandwidth) parameters of the analyzer. The setting menu includes [RBW Auto Man], [RBW Mode Def Con], [VBW Auto Man], [Average On Off], [EMI Filter▶].

5.5.1 [RBW Auto Man]

Adjust the resolution bandwidth ranging from 10Hz to 3MHz. Use numeric key, step key or knob to switch resolution bandwidth. The underline under Auto or Manual means Auto mode or Manual mode. Press [RBW Auto Manual] to have Auto underlined. Then the resolution bandwidth is under auto coupling mode.

Key points:

- Reducing the value of RBW will increase the frequency resolution, but may also cause sweeps to take longer (Sweep Time is affected by a combination of RBW and VBW when it is in Auto mode).
- RBW decreases with the span (non-zero span) in Auto RBW mode.

5.5.2 [RBW Mode Def Cont]

Adjust resolution step mode, resolution mode can be set to 1-3-5, Default or Continuous mode.

5.5.3 [VBW Auto Man]

Sets the desired video bandwidth in order to remove the band noise. Set the video resolution displays in function area, ranging from 10Hz to 30MHz by sequence step. You can modify this parameter by numeric key, step key or knob. The underline under Auto or Manual means Auto mode or Manual mode. Press [VBW Auto Manual] to have Auto underlined to return auto mode.

Key points:

- Reducing the VBW to smooth the spectrum line and differentiate small signals from the noise. However, this may cause a longer sweep time. (Sweep Time is affected by a combination of RBW and VBW when it is in Auto mode).
- VBW varies with RBW when it is set to Auto.

5.5.4 [Average On Off]

Trace average function. It doesn't need narrow VBW to implement smooth trace. This function set the wave detector to acquisition mode, continuously get average of the trace to smooth it.

5.5.5 [EMI Filter▶]

Pop out the menu for EMI measurement bandwidth.

1) [EMI Filter On Off]

Turn on or off EMI measurement resolution bandwidth.

2) [1MHz]

Set EMI measurement resolution to 1MHz.

3) [120kHz]

Set EMI measurement resolution to 120kHz.

4) [9kHz]

Set EMI measurement resolution to 9kHz.

5) [200Hz]

Set EMI measurement resolution to 200Hz.

5.6 【Marker】 bottom softkey

Key access: [Marker] softkey at the bottom of the screen

Markers are diamond- shaped characters that identify points of traces. The submenu on the right of the screen includes **【Marker▶】** , **【MarkerFctn▶】** , **【Marker→▶】** , **【Peak▶】** .

5.6.1 **【Marker ▶】** right softkey

Key access:

[Marker] bottom softkey → [Marker ▶] right softkey

We can easily readout the parameters of the marked point on the trace, such as the amplitude, frequency and sweep time.

Key points:

- The analyzer allows for up to five pairs of markers to be displayed simultaneously, but only one pair or one single marker can be active at a time.
- You can use the numeric keys, knob or direction keys to enter the desired frequency or time when any marker type menu is active, so as to view the readouts of different points on the trace.

5.6.1.1 **[Marker 1 2 3 4 5]**

Selects one marker, the default is Marker1, and place the marker at the center of the trace. If a delta marker is activated, this softkey changes to the menu under the [Delta] function.

If there is already a marker, this command will not produce any operation. If there are already two markers (e.g. in [Delta] mode), [Marker] changes the active marker to a new single marker.

Frequency and amplitude information can be obtained from the marker (time and amplitude information when the span is set as Zero Span), and these values are displayed in the active function area and in the upper right corner of the screen. You can use the knob, touch screen, or the numeric keys to move the active marker.

The marker reads data from the current active track (this track may be track A or track B). If both tracks are active or both tracks are in static display mode, the marker will read data from track A.

Touchscreen Control: When a marker is active, single-tap in the display area (at any level) to quickly move the marker to the desired frequency.

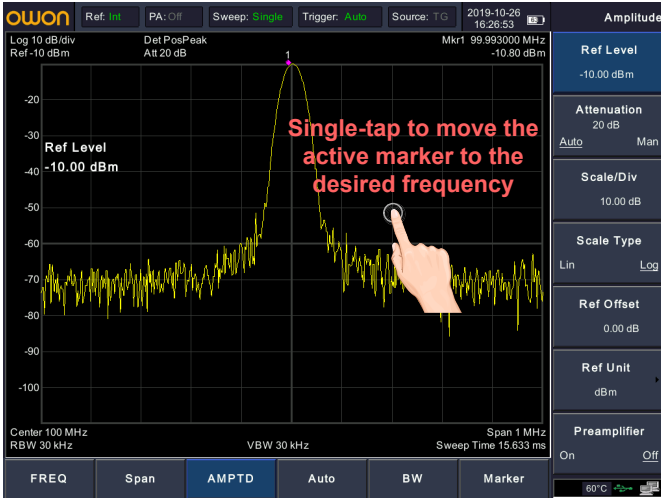

5.6.1.2 [Trace 1 2 3 4 5]

In the trace measurement, the marker used to activate the traces.

5.6.1.3 [Normal]

One of the marker types, which is used to measure the values of X (Frequency or Time) or Y (Amplitude) at certain point of the trace. When selected, a marker will appear with its marker number such as "1" on the trace.

Key points:

- If no active marker exists currently, a single frequency marker will be activated automatically at the center frequency of current trace.
- You can use the knob or numeric keys to move the marker. The readouts of the marker will be displayed on the upper right of the screen.
- The readout resolution of the X-axis corresponds to the span and sweep points. For higher resolution, add sweep points or reduce the span.

5.6.1.4 [Delta]

One of the marker types, which is used to measure the delta values of X (Frequency or Time) and Y (Amplitude) between the Reference point and certain point on the trace. When selected, a pair of markers appears on the trace, which are the Reference Marker and the Delta Marker.

Key points:

- If a single marker already exists, the reference marker will be activated at the position of current marker.
If no marker is active at the present, the reference marker and delta marker will appear at the center frequency location.
- The location of the Reference Marker is fixed (both in the X-axis and the Y-axis), while the Delta Marker is active. You can use the knob, touch screen, or the numeric keys to move the delta marker.
- The frequency (or time) and amplitude differences between the two markers will show in the active area and in the upper right corner of the display. The displayed amplitude difference is expressed in dB, or is the linear unit in terms of the corresponding scale.
- If [Delta] has been activated, press [Delta] again to move the reference marker to the active delta marker position.
- Two ways to enable a certain point as a reference marker:
 - a) Open a Normal marker and locate it onto a point and then switch the marker type into "Delta", creating a new reference, then you can modify the location of the delta marker to achieve the delta measurement.
 - b) Open a Delta Marker and place the delta marker onto a point, then press [Delta] again to locate the reference marker to this point, then you can modify the location of the delta point to achieve the delta measurement.

5.6.1.5 [Off]

Turn off the selected markers.

5.6.1.6 [All Off]

Turns off all the opened markers and the related functions. The marker won't show again.

5.6.1.7 [Marker Table On Off]

Turns on or off the display of the marker table.

5.6.2 【MarkerFctn ►】 right softkey

Key access:

[Marker] bottom softkey → [MarkerFctn ►] right softkey

Accesses the marker function setting menu.

5.6.2.1 [Function Off]

Turn off marker measurement function.

5.6.2.2 [NdB On Off]

Enables the N dB bandwidth measurement or sets the value of N. The N dB bandwidth denotes the frequency difference between points that are located on both sides of the current marker while the amplitude falls off (N<0) or rises (N>0) N dB separately,

Key points:

- When the measurement starts, the analyzer will search the two points which are located at both sides of the current point and are N dB amplitudes smaller or greater than the current point, and display the frequency difference between the two points.
- You can use the numeric keys, knob or direction keys to modify the value of N, 3 dB at default.

5.6.2.3 [Marker Noise On Off]

Turn on or off the marker noise function. The function of marker noise is applied to the selected marker, and reads the noise Power Spectral Density at the marked point. When turned on, the average noise level at the marked point is normalized to 1 Hz bandwidth for noise power.

5.6.2.4 [Freq Count ►]

Activate the frequency counter function and display the count results in the upper right corner of the screen. The counter counts only the signals that are displayed on the screen.

1) **[Freq Count On Off]**

Turn on or off the frequency counter function. This function is invalid when the tracking generator is activated. The count value is displayed in the upper right corner of the screen.

2) **[BW]**

Sets the frequency counter resolution. The allowed values are 1 Hz, 10 Hz, 100 Hz and 1 kHz. Changing the counter resolution can change the counter accuracy. The higher the resolution, the higher the counting accuracy.

5.6.3 【Marker→ ►】

Key access:

[Marker] bottom softkey, and then [Marker→ ►] right softkey

Use the current marker readings to set the parameters (such as Center frequency, Reference level).

5.6.3.1 [Mkr->CF]

Sets the center frequency of the analyzer to the frequency of the current marker. This feature quickly moves the signal to the center of the screen.

- In Normal marker mode, the center frequency will be set to the frequency of the current marker.
- In Delta marker mode, the center frequency will be set to the frequency at which the Delta Marker is located.
- The function is not available in zero span mode.

5.6.3.2 [Mkr->CF Step]

Sets the center frequency step of the analyzer to the frequency of the current marker.

- In Normal marker mode, the center frequency step will be set to

the frequency of current marker.

- In Delta marker mode, the center frequency step will be set to the frequency at which the Delta Marker is located.
- The function is not available in zero span mode.

5.6.3.3 [Mkr->Start]

Sets the start frequency of the analyzer to the frequency of the current marker.

- In Normal marker mode, the start frequency will be set to the frequency of the current marker.
- In Delta marker mode, the start frequency will be set to the frequency at which the Delta Marker is located.
- The function is not available in zero span mode.

5.6.3.4 [Mkr->Stop]

Sets the stop frequency of the analyzer to the frequency of the current marker.

- In Normal marker mode, the stop frequency will be set to the frequency of the current marker.
- In Delta marker mode, the stop frequency will be set to the frequency at which the Delta Marker is located.
- The function is not available in zero span mode.

5.6.3.5 [Mkr->Ref Level]

Sets the reference level of the analyzer to the amplitude of the current marker.

- In Normal marker mode, the reference level will be set to the amplitude of the current marker.
- In Delta marker mode, the reference level will be set to the amplitude at which the Delta Marker is located.

5.6.3.6 [Mkr Δ ->Span]

Sets the span of the analyzer to the frequency difference between the two markers in Delta marker mode.

5.6.3.7 [Mkr Δ ->CF]

Sets the center frequency of the analyzer to the frequency difference between the two markers in Delta marker mode.

5.6.4 【Peak ▶】

Key access:

[Marker] bottom softkey → [Peak ▶] right softkey

Accesses the Peak setting menu.

Key Points:

The spurious signal at the zero frequency caused by LO feed through is ignored.

5.6.4.1 [Max Search]

Place a frequency marker at the highest point of the trace, and display the frequency and amplitude of the marker in the upper right corner of the screen. [Max search] does not change the activated function.

5.6.4.2 [Next Peak]

Searches the peak whose amplitude is the closest to that of the current peak. The peak is then identified with a marker. When this key is pressed repeatedly, you can quickly find a lower peak.

5.6.4.3 [Left Peak]

Searches the nearest peak located to the left of the current marker. The peak is then identified with a marker.

5.6.4.4 [Right Peak]

Searches the nearest peak located to the right of the current marker. The peak is then identified with a marker.

5.6.4.5 [Min Search]

Searches the peak with the minimum amplitude on the trace and identifies it with a marker.

5.6.4.6 [Mkr→CF]

Used to move the peak point to the center frequency point.

5.6.4.7 [Cont Max On Off]

Enables or disables the Cont Max search, the default is Off. When enabled, the system will always execute a peak search automatically after each sweep in order to track the signal under measurement.

5.7 【Trace】 hardkey

Key access:

Press  Shift key, then **Trace** hardkey (7 in numeric keypad).

As the sweep signal is displayed as a trace on the screen, you can set parameters about the trace using this key. The analyzer allows for up to five traces to be displayed at one time. Press this key to access the menu for trace. It includes [Trace 1 2 3 4 5], [Clear Write], [Max Hold], [Min Hold], [Blank], [View], [Operations ►], [1 ↔ 2], [2-DL → 2], [2 ↔ 3], [1 → 3] and [2 → 3].

5.7.1 [Trace 1 2 3 4 5]

Select trace, the analyzer offers 1,2,3,4,5 trace. The selected trace number in the menu will be underlined.

5.7.2 [Clear Write]

Erase the trace data, and updates current display during following sweeps of the analyzer.

5.7.3 [Max Hold]

Maintains the maximum for each point of the trace, and updates

each trace point if a new maximum level is detected in successive sweeps.

5.7.4 [Min Hold]

Maintains the minimum for each point of the trace, and updates each trace point if a new minimum level is detected in successive sweeps.

5.7.5 [Blank]

Clear the trace on screen. The selected trace register stores the trace data, and will not be updated as the analyzer sweeps.

5.7.6 [View]

Holds and displays current trace for observation. The trace register is not updated as the analyzer sweeps.

5.7.7 [Operations▶]

Enter the trace math submenu.

1) [1 ↔ 2]

Exchange the trace register 1 data with the trace register 2, and place them in display mode.

2) [2-DL → 2]

Subtracts the display line value from the trace register 2. This function executes once when activated. Press [2-DL → 2] again to execute it the second time. When this function activated, the display line will also be activated.

3) [2 ↔ 3]

Exchange the trace register 2 data with the trace register 3, and place them in display mode.

4) [1 → 3]

Change the trace register 1 data to the trace register 3, and place the trace register 3 data in display mode.

5) [2 → 3]

Change the trace register 2 data to the trace register 3, and place the trace register 3 data in display mode.

5.8 【Detector】 hardkey

Key access:

Press  Shift key, then **Detector** hardkey (8 in numeric keypad).

While displaying a wider span, each pixel contains spectrum information associated with a larger subrange. That is, several samples may fall on one pixel. Which of the samples will be represented by the pixel depends on the selected detector type. The submenu includes [Pos Peak], [Neg Peak], [Normal], [Sample], [RMS Avg], [Voltage Avg], [Quasi-Peak].

Key points:

- Selects an appropriate type according to the application in order to ensure the accuracy of the measurement for your application.
- When **【BW】** bottom softkey→[EMI Filter▶]→[EMI Filter] is On, [Quasi-Peak] is available.

Table 5-1 Detector type comparison

Detector Type	Measurement
Pos Peak	<i>Positive peak detector</i> ensures that no peak signal is missed, which is useful for measuring signals that are very close to the base noise.
Neg Peak	<i>Negative peak detector</i> is used in most cases with the self-test of the spectrum analyzer and is rarely used in the measurement. It is able to restore the modulation envelope of the AM signal well.
Normal	Display pos peak and neg peak alternately when noise is detected, or it only display pos peak.
Sample	<i>Sampling detector</i> is conducive to measurement noise signal. Compared with the standard detection method, it can measure noise better.

RMS Avg	<i>RMS Average detector</i> averages rms levels to calculate the true average power. It is best for measuring the power of complex signals.
Voltage Avg	<i>Voltage Average detector</i> averages the linear voltage data of the envelope signal measured during the bucket interval. It is useful for observing rise and fall behavior of AM or pulse-modulated signals.
Quasi-Peak	<i>Quasi-peak detector</i> is a weighted form of peak detection. The measured value drops as the repetition rate of the measured signal decreases. It is used in EMI testing.

5.8.1 [Pos Peak]

Searches the maximum from the sampling data segment and displays it at the corresponding pixel.

5.8.2 [Neg Peak]

Searches the minimum from the sampling data segment and displays it at the corresponding pixel.

5.8.3 [Normal]

When noise is detected, the positive and negative peaks are alternately displayed, otherwise only positive peaks are displayed.

5.8.4 [Sample]

Chooses any point data from the sampling data segment and displays at the corresponding pixel. This mode is usually used for video averaging and noise frequency Maker.

5.8.5 [RMS Avg]

Set the detector to the RMS Average detector mode. This mode calculates the RMS average power of all the samples in the sample bucket.

5.8.6 [Voltage Avg]

Set the detector to the Voltage Average detector mode. This mode calculates the average voltage of all the samples in the sample bucket.

5.8.7 [Quasi-Peak]

Set the detector to the Quasi-Peak detector mode. This mode is available when EMI filter is turned on. The quasi-peak detector is a peak detector that is weighted by the duration and repetition rate of the signal, as specified by the CISPR 16-1-1 standard. Quasi-peak detection is characterized by a fast charge time and slow decay time.

5.9 【Display】 hardkey

Key access:

Press  Shift key, then **Display** hardkey (**9** in numeric keypad).

Controls the screen display of the analyzer, such as full screen, setting the on or off for window zoom, display line, amplitude scale, grid and label.

5.9.1 [Full Screen]

Set to full-screen display graphical interface, press any key to exit.

5.9.2 [Zoom On Off]

In multi-window display mode, press this button to zoom in on the selected window. Press the key for the first time to enlarge the selected window to the entire graphic display area. Press this button again to exit the entire graphic display area and restore the multi-window display mode.

5.9.3 [UI Setting ►]

Access the UI setting submenu.

5.9.3.1 [Display Line On Off]

When this menu is on, an adjustable horizontal reference line is

activated on the screen.

5.9.3.2 [Ampt Graticule On Off]

Turn on or Off amplitude scale function.

5.9.3.3 [Grid On Off]

It's the grid lines displaying and hiding menu. When the grid display line is on, pressing [Grid On Off] again will turn it off.

5.9.3.4 [Label On Off]

Defines the content displayed or hidden in the comments that appear in the display grid area.

5.9.3.5 [Menu Hiding On Off]

Set the hiding time of right menu (off, or 5 – 60 seconds). The right menu is hidden after the specified time when no keys or touch screen operation.

5.9.4 [Screen Setting ►]

Access the screen setting submenu.

5.9.4.1 [Brightness]

Toggle the screen brightness between **Auto** and **Man**. When it is set to **Auto**, the brightness adjusts according to the environment automatically with the built-in light sensor. When it is set to **Man**, you can set a fixed brightness value manually (0 - 100).

5.9.4.2 [Sleep]

Turn on/off the sleeping mode which turns off the LCD display after

a user-defined idle time (1 to 60 minutes). Press the power key to re-activate the LCD display after the LCD display sleeping mode has been triggered.

5.10 【Sweep】 hardkey

Key access:

Press  Shift key, then **Sweep** hardkey (4 in numeric keypad).

Sets parameters about the Sweep time and mode including [Sweep Time Auto Manual], [Sweep Single], [Sweep Cont], [Sweep Points].

5.10.1 [Sweep Time Auto Man]

Sets the time interval for the analyzer to complete a sweep.

- In non-zero span, the analyzer uses the shortest sweep time on the basis of the current RBW and VBW settings if Auto is selected.
- You can modify this parameter using the numeric keys, knob, or direction keys.

5.10.2 [Sweep Single]

Press to set the sweep mode to single sweep. In this mode, pressing [Sweep Single] enables a sweep.

5.10.3 [Sweep Cont]

Press [Sweep Cont] to set the sweep mode to continuous sweep. The analyzer performs one sweep after another as soon as it is triggered.

5.10.4 [Sweep Points]

Sets the desired points for every sweep. That is the number of points of the current trace.

Key Points:

- Changing the points may influence the sweep time which is limited by the sample rate of the ADC (Analog to Digital Converter). That is, the more points used, the longer the sweep will be.
- Changing the points would also influence other system parameters, thus the instrument restarts the sweep and measurement cycle.
- You can modify this parameter using the numeric keys, knob or direction keys.

5.11 【Trig】 hardkey

Key access:

Press  Shift key, then **Trig** hardkey (**5** in numeric keypad).

Sets the trigger mode and other associated parameters, submenu includes [Auto Run], [Video], [External ▶].

5.11.1 [Auto Run]

Set the trigger mode to free run mode. In this mode, new sweep starts as soon as possible after the current sweep ends.

5.11.2 [Video]

In Video mode, a trigger signal will be generated when the system detects a video signal in which the voltage exceeds the specified video trigger level.

Use the numeric keys, knob or direction keys to set the trigger level in Video mode. The screen will display corresponding line Trigger Level and the value.

5.11.3 [External ▶]

In this mode, an external signal (TTL signal) is input from the [Trig In] connector at the top panel, of which the edge conditions should meet with the user settings to generate trigger signals.

Press [External ▶] to access the submenu, select [Positive Edge] or [Negative Edge] as the trigger condition.

5.12 【Source】 hardkey

Key access:

Press  Shift key, then **Source** hardkey (6 in numeric keypad).

When the Source is turned on, an independent signal or a signal with the same frequency of the current sweep signal will be output from the GEN Output 50Ω terminal on the top panel. Press the key to access the submenu includes [Output On Off], [Source GEN CW TG], [Output Level], [Output FREQ], [OF Step], [Network Meas ►]. The source is turned off in the power-on and reset states.

5.12.1 [Output On Off]

Turn on/off the output of the GEN Output 50Ω terminal on the top panel.

5.12.2 [Source Gen CW TG]

Select source as CW (Continuous Wave) or TG (Tracking Generator).

CW: Output independent continuous wave signal. (CW output function is only for specific models.)

TG: RF output and spectrum reception are fully synchronized on the frequency sweep, and the tracking source frequency can not be set individually.

5.12.3 [Output Level]

Set the output power of CW or TG source.

5.12.4 [Output FREQ]

When the source is “CW”, set the output frequency of CW source.

5.12.5 [OF Step]

When the source is “CW”, set the output frequency step of CW source.

5.12.6 [Network Meas▶]

When the source is "TG", tracking source network measurement function is available, mainly for amplitude and frequency characteristics measurement; RF output and spectrum measurement is fully synchronized, can be used as a scalar network analyzer. When the network measurement function is "on", the measurement results show relative values after "normalized", expressed in "dB". When the network measurement function is "off", the measurement shows the spectrum measurement result, expressed in "dBm".

1) [Network Meas On Off]

Turn on or off the tracking source network measurement function. Tracking source network measurement function, mainly for amplitude and frequency characteristics measurement; RF output and spectrum measurement is fully synchronized, can be used as a scalar network analyzer. When the network measurement function is "on", the measurement results show relative values after "normalized", expressed in "dB". When the network measurement function is "off", the measurement shows the spectrum measurement result, expressed in "dBm".

2) [Output Level]

Used to set the output power of the trace source.

3) [Ref Level]

This soft menu is used to track the source network measurement of the user to adjust the measurement results display location.

4) [Sweep Points]

Used to set the number of scanning points for network measurements.

5) [Sweep Time]

Used to set the scan time for network measurements.

6) [Normalize]

This soft menu is used to track the user's field calibration of the source network measurements. After connecting the instrument's RF output to the RF input, press the "normalized" soft menu and the display shows a straight line on the 0dB scale.

5.13 【Demod】 hardkey

Key access:

Press  Shift key, then **Demod** hardkey (1 in numeric keypad).

Enter the demodulation settings, the spectrum analyzer supports audio demodulation and AM, FM analog demodulation.

5.13.1 [Audio Demod ►]

Enter Audio Demodulation submenu.

5.13.1.1 [Audio Demod]

Turn audio demodulation on or off.

5.13.1.2 [Demod Mode ►]

Enter the demodulation mode submenu, including FMW, FM, AM, USB, LSB.

5.13.1.3 [Sound]

When the audio demodulation is on, adjust the headphone output volume.

5.13.1.4 [RadioSet ►]

Quick access to the common broadcast band.

5.13.2 [Analog Demod ►]

Enter the analog demodulation submenu.

5.13.2.1 [AM ►]

Enter AM demodulation submenu.

1) **[AM On Off]**

Turn AM demodulation On or Off.

2) **[Carrier Freq]**

Set the carrier frequency of the AM modulation signal.

3) **[IF BW Auto Man]**

Set the demodulation bandwidth to auto or manual mode.

5.13.2.2 **[FM ▶]**

Enter FM demodulation submenu.

1) **[FM On Off]**

Turn FM demodulation On or Off.

2) **[Carrier Freq]**

Set the carrier frequency of the FM modulation signal.

3) **[IF BW Auto Man]**

Set the demodulation bandwidth to auto or manual mode.

5.14 **【System】 hardkey**

Key access:

Press  Shift key, then **System** hardkey (2 in numeric keypad).

The menu for system parameter settings includes [System ▶], [Setting ▶], [PowerOn/Preset ▶], [Calibration ▶], [Printer ▶], [Save/Recall ▶]. For first time you use the spectrum analyzer, set the system settings, the system will store the settings, restart the machine after power off won't change the settings.

5.14.1 **[System ▶]**

Access system information, firmware update, and option submenu.

5.14.1.1 [System Info]

Display the current system information, such as serial number, firmware version, temperature, MAC address, etc.

5.14.1.2 [Firmware Update]

To update your instrument firmware, do the following:

1. Create a folder named “spectrum” (lowercase) on the root directory of the USB memory device, and copy the firmware file onto this folder.
2. Insert the USB memory device into the top panel USB connector on your instrument. Press  Shift key, then **System** hardkey. Press [**System ▶**], and press [**Firmware Update**] to execute firmware update.
3. The analyzer will perform the update process. The upgrade procedure will take approximately 30 seconds. During the update process, do not remove the USB memory device, do not power off the instrument or press any key. If the update process fails, please report the problem to your distributor or our technical support.
4. Once the upgrade is completed, the instrument will automatically restart.

5.14.1.3 [Option]

Access the option submenu. TG, EMI, CW can be selected as option.

5.14.2 [Setting ▶]

Access the submenu for setting the analyzer, including [LAN ▶], [Control ▶], [Shutdown], [Language ▶], [Date/Time ▶].

5.14.2.1 [LAN ▶]

Access the submenu for LAN port configuring. The analyzer supports LAN port connection for data transfer.

- 1) [**IP**]
Sets the IP address of the LAN port.
- 2) [**Mask**]

Sets the subnet mask parameter.

3) [Gate]

Sets the default gateway address.

4) [DHCP On Off]

One of the setting methods of IP address. The DHCP server assigns an IP address, subnet mask and gateway to the analyzer on the basis of the current network status.

5.14.2.2 [Control ►]

Access the submenu for touch control and other control settings.

1) [TouchControl ►]

Access the submenu for touch control.

[Touch Control]

Turn on/off the touch control.

[Align X]

When dragging up or down in the display area, the reference level is changed to align to the grid of X-axis.

[Align Y]

When dragging left or right in the display area, the center or start frequency is changed to align to the grid of Y-axis.

2) [Button Sound]

Turn on/off the button beep sound.

3) [UnDo]

Undo the last operation.

4) [ReDo]

The redo function restores the last operation that have been previously undone.

5.14.2.3 [Shutdown]

Turn on/off the automatic shutdown function. When this function is on, the analyzer will automatically shut down in a user-defined time

(5 to 240 minutes). You can modify the time using the numeric keys, knob, or direction keys.

5.14.2.4 [Language ►]

Selects the screen menu language.

5.14.2.5 [Date/Time ►]

Sets the date, time, and display format of the analyzer.

- **[Date/Time On Off]**

Turn on or off date/time display.

- **[Format ►]**

Selects the display format. Date and time can be displayed as [YMD HMS] or [HMS YMD].

- **[Date Set]**

Set the date for the analyzer. Use the numeric keys to enter the date. The format is YYYYMMDD.

E.g. June 22th, 2012 should be entered as 20120622.

- **[Time Set]**

Set the time for the analyzer. Use the numeric keys to enter the time. The format is HHMMSS.

E.g. 16:55:30 should be entered as 165530.

5.14.3 [PowerOn/Preset►]

Sets the analyzer power on setting or preset setting.

- 1. [Power Set ►]**

Select power-on settings as [Factory], [User], or [Last].

- 2. [Preset ►]**

Select preset setting as [Factory], [User], or [Last].

[Factory]

Restores the analyzer to its factory- defined settings. The factory default settings are in Table 5-2.

[User]

Restores the analyzer to a user-defined setting.

To save the current system setting as a user-defined setting, press **↑** Shift key, then **System** hardkey, press **[Save/Recall ▶]** and select the **[User State ▶]** menu item.

[Last]

Restores the analyzer to the user setting at last shutdown.

Table 5-2 [Factory] Settings

Parameter	Value	
Frequency		
Center Frequency	HSA015-TG	750.009000 MHz
	HSA032-TG	1.600009000 GHz
Start Frequency	9.000 kHz	
Stop Frequency	HSA015-TG	1.500009000 GHz
	HSA032-TG	3.200009000 GHz
Frequency Step	HSA015-TG	Auto 150.000000 MHz
	HSA032-TG	Auto 320.000000 MHz
Frequency Offset	0 Hz	
Frequency Reference	Internal	
SPAN		
Sweep	HSA015-TG	1.500000000 GHz
	HSA032-TG	3.200000000 GHz
AMPTD		
Reference Level	0.00 dBm	
Attenuator	HSA015-TG	Auto 10 dB
	HSA032-TG	Auto 20 dB
Scale/Div	10.00 dB	
Scale Type	Log	
Ref Offset	0.00 dB	
Ref Unit	dBm	
Preamplifier	Off	
BW		
RBW	Auto 3 MHz	

Resolution Step	Default
VBW	Auto 3 MHz
Trace Average	Off
Detector	
Detector Type	Pos Peak
Sweep	
Sweep Time	Auto 20.000 ms
Sweep Mode	Continuous Sweep
Source	
Source TG	Off
Network Meas	Off
Trace	
Trace	1
Trace Type	Clear Write
Trace 1 Operations	1 ↔ 2
Display	
Full Screen	Off
Window Zoom	Off
Display Line	Off
Amplitude Graticule	Off
Grid	On
Label	On
Trig	
Trigger Type	Auto Run
Peak	
Peak Search	Off
Marker Fctn	
NdB	Off
Marker Noise	Off
Frequency Count	Off
Marker	
Marker	1

Trace	1
Marker Table	Off
Meas	
Time Spectrum	Off
ACPR	Off
Channel Power	Off
OBW	Off
Pass-Fail	Off
Meas Setup	
Channel Bandwidth	1.000000 MHz
Channel Internal	2.000000 MHz
Channel Numms	3
Power Percent	99.00%
Printer	
Page Size	A4
Print Language	Pcl
Printer Type	Black/White
Orientation	Horizontal
Copy Number	1

5.14.4 [Calibration ►]

Access user calibration submenu including [Calibration] and [Factory].

1) [Calibration]

Set the signal generator frequency as 440 MHz, power as -20 dBm, access to RF instrument RF input, press the [Calibration] softkey, start the implementation of user calibration.

2) [Factory]

If you do not need the user calibration compensation data, press the [Factory] softkey to clear the data and return to the factory status.

5.14.5 [Printer ►]

Access the relative soft menu for printing.

5.14.5.1 [Page Size]

Select the paper size to be printed, including A4, A3, B5, C5, Letter.

5.14.5.2 [Language Pcl Esc]

Select the print language, optional for Pcl and Esc.

5.14.5.3 [Printer Type Blak Color]

Select the printer type to gray or color.

5.14.5.4 [Orientation Hor Ver]

Select the print orientation to horizontal or vertical.

5.14.5.5 [Number]

Set the print copies.

5.14.5.6 [Print Trace]

Print the current trace.

5.14.5.7 [Print Screen]

Print the full screen.

5.14.6 [Save/Recall ►]

Accesses the menu to save/recall the screenshot, trace data, or user state.

5.14.6.1 [Screen Pixmap ►]

Enter screenshot save submenu, you can choose to save screenshots to local memory or USB disk, the image file format is PNG. The file name is automatically created using the current date and time.

When [**Save to USB**] is selected, the screenshot will be saved in a

folder named spectrum (created automatically) in USB disk.

5.14.6.2 [Trace Data ►]

Enter the trace data save submenu, you can choose to save the trace data to local memory or USB disk, the trace data file format is CSV. The file name is automatically created using the current date and time.

When [**Save to USB**] is selected, the trace file will be saved in a folder named spectrum (created automatically) in USB disk.

5.14.6.3 [User State ►]

Save the current system setting as a user self-defined setting to local memory. The user setting file can be used as the power-on setting or preset setting.

5.14.6.4 [Recall ►]

Accesses the submenu to recall the screenshot, trace data, or user state.

1) [Type ►]

Select the file type you wish to view under the directory, includes screen image, trace data, user states, or display all.

- **Screens (*.png)**

A screen file is the captured graphic of the screen.

- **Trace Datas (*.csv)**

A trace file records trace data.

- **User States (*.user)**

A user state file records the current controls and settings of the analyzer.

2) [Sort ►]

The files can be sorted in order by name, date&time, or size.

Selects the item by which folders and files are sorted in the file list.

3) [First Page]

Go to the first page of current directory.

4) [Prev Page]

Go to the previous page.

5) [Next Page]

Go to the next page.

6) [Load]

Recall the selected file.

5.15 【File】 hardkey

Key access:

Press  Shift key, then **File** hardkey (**3** key in numeric keypad).

Access the file management menu.

5.15.1 [Refresh]

Update the file list in the directory.

5.15.2 [Type ►]

Select the file type you wish to view under the directory, includes screen image, trace data, user states, or display all.

- **Screens (*.png)**

A screen file is the captured graphic of the screen.

- **Trace Datas (*.csv)**

A trace file records trace data.

- **User States (*.user)**

A user state file records the current controls and settings of the analyzer.

5.15.3 [First Page]

Go to the first page of current directory.

5.15.4 [Prev Page]

Go to the previous page.

5.15.5 [Next Page]

Go to the next page.

5.15.6 [Last Page]

Go to the last page of current directory.

5.15.7 [Operations ►]

Access the submenu for file operations, includes [Sort ►], [Delete ►], [Export ►], [Load].

5.15.7.1 [Sort ►]

The files can be sorted in order by name, date&time, or size.
Selects the item by which folders and files are sorted in the file list.

5.15.7.2 [Delete ►]

Press [**Delete Select**] to delete the selected file.
Press [**Delete Page**] to delete the files in current page.
Press [**Delete All**] to delete all the files.

5.15.7.3 [Export ►]

When a USB disk is inserted, you can export the files in the local memory to the USB disk.
Press [**Select**] to export the selected file to USB disk.
Press [**Page**] to export the files in current page to USB disk.
Press [**All**] to export all the files to USB disk.

5.15.7.4 [Load]

Recall the selected file.

5.15.7.5 [Power Set]

When the user state file (the type is user) is selected in the left list, you can press [**Power Set**] to set this user state as power-on setting.

5.15.7.6 [Preset]

When the user state file (the type is user) is selected in the left list, you can press [**Preset**] to set this user state as preset setting.

5.16 【Measure】 hardkey

Key access:

Press  Shift key, then **Measure** hardkey (**point** key in numeric keypad).

Provide a variety of advanced measurement functions, accesses the spectrum analyzer built-in and user-defined measurement function soft menu, turn on or off the time spectrum, adjacent channel power measurement, channel power measurement, occupied bandwidth, Pass-Fail measurement menu.

5.16.1 [Measure off]

You can directly close the currently running measurement function, you can also choose to close the measurement menu.

5.16.2 [Time Spec On Off]

Turn on time spectrum measure mode.

5.16.3 [ACPR On Off]

Turn on or off the adjacent channel power measurement.

Press **【Meas Setup ►】** to enter the parameters of the adjacent channel power measurement submenu. The adjacent channel power is used to measure the ratio of the adjacent channel power of the transmitter. The absolute value of the main channel power and the absolute value of the adjacent channel power are obtained by the linear power integration method, so that the adjacent channel power ratio is gained.

5.16.4 [Chanel Power On Off]

Turn on or off channel power measurements.

Press **【Meas Setup ►】** to enter the channel power measurement parameter settings submenu. The channel power is used to measure the transmitter channel power, according to the user set the channel bandwidth, through the linear power integration method to obtain the absolute value of the main channel power.

5.16.5 [OBW On Off]

Turn on or off the occupied bandwidth measurement.

Press **【Meas Setup ►】** to enter the parameter setting submenu for occupying the bandwidth measurement. Occupied Bandwidth is a measure of the bandwidth occupied by the transmitter signal can be measured from the total power ratio within the in-band power span, with a default value of 99% (the user can set this value).

5.16.6 [Pass-Fail ►]

Enter the pass / fail measurement function submenu. Pass / fail measurement has two modes of window measurement and limit measurement.

5.16.6.1 [Window Meas►]

Enter Window measurement submenu.

1) [Window Meas On Off]

Turn on or off window measurement mode.

2) [Limit Line On Off]

Turns the amplitude line on or off, and the amplitude line turns on when the window measurement is on.

3) [Freq Line On Off]

Turns the frequency line on or off, and the frequency line turns on when the window measurement is on.

4) [Limit Set Up Low]

Used to edit the upper and lower limit on the amplitude line.

5) [Freq Set Start Stop]

Start and stop frequencies for scanning line for editing.

6) [Window Sweep On Off]

Turns window sweep on or off. When the window sweep is on, only the window formed by the intersection of the amplitude line and the frequency line is scanned. The peripheral stops scanning; the full frequency is scanned when it is closed.

5.16.6.2 [Limit Meas ►]

Enter the submenu of the limit measurement mode.

1) [Limit Meas On Off]

Turn On or Off limit measurement mode.

2) [Line Up On Off]

When the upper limit line is turned on or off, the upper limit line is opened by default when the area measurement is on.

3) [Line Low On Off]

When the lower limit line is turned on or off, the lower limit line is opened by default when the area measurement is on.

4) [Shift X/Y Freq Ampt]

Frequency: For the actual measurement, the edited area as a whole superimposed on a frequency, so that it can implement left or right shift, easy to measure. Does not affect the frequency and marker of the spectrum analyzer settings.

Amplitude: The region has been edited on the whole superimposed on a degree, so that it can move up or down, easy to measure. Does not affect the amplitude setting of the spectrum analyzer.

5) [UpLine Edit ►]

Upper line editing is used to edit the control line above the trace, depending on the trace.

6) [LowLine Edit ►]

Lower line editing is used to edit the control line above the trace, depending on the trace.

5.16.7 【Meas Setup ►】

Measurement setting menu for the corresponding measurement parameter settings when adjacent channel power, channel power, occupied bandwidth measurement mode is turned on.

5.16.7.1 [Channel BW]

Set the bandwidth of the channel power measurement, and set the total display power percentage of bandwidth.

5.16.7.2 [Channel Interval]

Set the center frequency difference of the primary channel to the adjacent channel.

5.16.7.3 [Channel Numms]

Set the number of upper and lower adjacent channels measured by adjacent channel power.

5.16.7.4 [Power Percent]

Set the power ratio of occupied bandwidth.

6. Specification

This chapter lists the technical specifications and general technical specifications of the spectrum analyzer. Unless otherwise stated, the technical specifications apply to the following conditions:

- The instrument has been preheated for 30 minutes before use.
- The instrument is in the calibration cycle and has been self-calibrated.

"Typical" and "nominal" for this product are defined as follows

- Typical: Refers to the performance of the product under certain conditions.
- Nominal: Refers to the approximate value under product application process.

Frequency		
Frequency Range	HSA015-TG	9 kHz to 1.500009 GHz
	HSA032-TG	9 kHz to 3.200009 GHz
Frequency	1 Hz	
Frequency Span		
Span Range	0 Hz, 100 Hz to max frequency of instrument	
Span Uncertainty	± span / (sweep points-1)	
Internal Frequency Reference		
Reference Frequency	10.000000 MHz	
Reference Frequency Accuracy	±[(days since last calibrate × freq aging rate) + temperature stability + initial accuracy]	

Temperature stability	<2.5 ppm (15°C to 35°C)	
Aging rate	<1 ppm/year	
SSB Phase Noise (20°C to 30°C,fc=1 GHz, RBW=1 kHz, VBW=1 kHz)		
Carrier Offset	10 kHz	< -80 dBc/Hz (Typical)
	100 kHz	< -100 dBc/Hz (Typical)
	1 MHz	< -107 dBc/Hz (Typical)
Bandwidth		
Resolution Bandwidth	10 Hz to 500 kHz (1-10 steps by sequence), 1 MHz, 3 MHz	
RBW Accuracy	< 5%, typical (RBW ≤ 1 MHz)	
Resolution Filter Shape Factor (60 dB: 3 dB)	<5: 1 typical (digital and close to Gaussian shape)	
Video Bandwidth (VBW)	10 Hz to 3 MHz	
Amplitude and level		
Amplitude measurement range	DANL to +20 dBm, 1 MHz to 3.2 GHz, Preamp Off	
Reference Level	-80 dBm to +30 dBm, 0.1dBm by step	
Preamp	HSA015-TG	20 dB, nominal, 100 kHz to 1.5GHz
	HSA032-TG	20 dB, nominal, 100 kHz to 3.2 GHz
Input Attenuator Range	HSA015-TG	0 to 40 dB, in 1 dB step
	HSA032-TG	0 to 50 dB, in 1 dB step
Max Input DC Voltage	±50 VDC	
Max continuous power	+30dBm, average continuous power	

Display Average Noise Level			
(Input Attenuation= 0 dB, Sample Detector ,Trace Average ≥20, 20°C to 30°C, Input Impedance=50 Ω ,RBW normalizes to 1Hz)			
Preamp Off	1 MHz to 1 GHz		-140 dBm (Typical), <-130 dBm
	HSA015-TG	1 GHz to 1.5 GHz	-138 dBm (Typical),
	HSA032-TG	1 GHz to 3.2 GHz	<-128 dBm
Preamp On	1 MHz to 1 GHz		-160 dBm (Typical), <-150 dBm
	HSA015-TG	1 GHz to 1.5 GHz	-158 dBm (Typical),
	HSA032-TG	1 GHz to 3.2 GHz	<-148 dBm
Frequency response			
(20°C to 30°C, 30% to 70% relative humidity, input attenuation=21 dB, reference frequency=50 MHz)			
Preamp Off ($f_c \geq 100K$)	± 0.8 dB; ± 0.4 dB (Typical)		
Preamp On ($f_c \geq 1$ MHz)	± 0.9 dB; ± 0.5 dB (Typical)		
Difference and Accuracy			
RBW Switch Difference	RBW=10 kHz Log resolution= ± 0.2 dB, Lin resolution= ± 0.01 . Nominal		
Input Attenuation Difference	HSA015-TG	20°C ~ 30°C, $f_c=50$ MHz, Preamplifier Off, 10 dB RF attenuation, input signal 1~40dB ± 0.5 dB	
	HSA032-TG	20°C ~ 30°C, $f_c=50$ MHz, Preamplifier Off, 20 dB RF attenuation, input signal 1~50dB ± 0.5 dB	

Absolute Amplitude Accuracy	20°C to 30°C, fc=50 MHz, Span=200 kHz, RBW=10 kHz, VBW=10 kHz, peak detector, 10 dB RF attenuation,95% confidence level Preamp Off ±0.4 dB, input signal level -20 dBm Preamp On ±0.5 dB, input signal level -40 dBm	
Uncertainty	Input signal range 0 dBm to -50 dBm	
	±1.5 dB	
VSWR	Input 10 dB RF attenuation, 1MHz to 3.6 GHz	
	<1.5, Nominal	
Distortion and spurious response		
Second harmonic distortion	fc ≥ 50 MHz, Preamp off, signal input -10 dBm, 0 dB RF attenuation, 20°C to 30°C	
	-65 dBc	
Third-order intermodulation	fc ≥ 50 MHz, Input double tone level -20 dBm, frequency interval 100 kHz, input attenuation 0 dB, preamplifier off, 20°C to 30°C	
	+10 dBm	
1 dB Gain Compression	fc ≥ 50 MHz, 0 dB RF attenuation, Preamp off , 20°C to 30°C	
	>+2 dBm, nominal	
Residual response	connect 50 Ω load at input port, 0 dB input attenuation, 20°C to 30°C	
	<-85 dBm, typical	
Input related spurious	-30 dBm signal at input mixer, 20°C to 30°C	
	<-60 dBc	
Sweep		
Sweep Time	None-zero Span	10 ms to 3000 s
	Zero Span	10 ms to 3000 s

Sweep Mode		Continuous, Single	
Tracking Source Output, signal generator			
Frequency Range		HSA015-TG	100 kHz to 1.5 GHz (Tracking Source Output)
		HSA032-TG	100 kHz to 3.2 GHz (Tracking Source Output)
Output power level range		HSA015-TG	-30 dBm to 0 dBm
		HSA032-TG	-40 dBm to 0 dBm
Output power level resolution		1 dB	
Output flatness		± 3 dB	
Maximum safe reverse level		Average total power: ±30 dBm, DC: ±50 VDC	
Demodulation			
Audio Demodulation	Frequency Range	HSA015-TG	100 kHz to 1.5 GHz
		HSA032-TG	100 kHz to 3.2 GHz
	Demodulation Type	FM/AM	
AM Measurement	Frequency Range	HSA015-TG	100 kHz to 1.5 GHz
		HSA032-TG	100 kHz to 3.2 GHz
	Modulation rate	20 Hz to 100 kHz	
	Modulation Rate Accuracy	1Hz, nominal (Modulation rate < 1 kHz) <0.1% modulation rate, nominal (Modulation rate ≥ 1 kHz)	
	Depth	5% to 95%	
	Depth Accuracy	±4%, nominal	
FM	Frequency	HSA015-TG	100 kHz to 1.5 GHz

Measur- -ement	Range	HSA032-TG	100 kHz to 3.2GHz
	Modulation rate	20 Hz to 100 kHz	
	Modulation Rate Accuracy	1 Hz, nominal (Modulation rate < 1 kHz) <0.1% modulation rate, nominal (Modulation rate ≥ 1 kHz)	
	Deviation	20 Hz to 200 kHz	
	Deviation Accuracy	±4%, nominal	
Frequency Counter			
Resolution		1Hz, 10Hz, 100Hz, 1kHz	
Accuracy		±(frequency indication × frequency reference accuracy + counter resolution)	
RF Input			
Impedance		50 Ω, typical	
Connector		N Type Female	
Tracking Generator Output			
Impedance		50 Ω, typical	
Connector		N Type Female	
10MHz Reference Input / Output			
Connector		BNC female	
10MHz Reference Amplitude		0 dBm to +10 dBm	
External Trigger in			
Connector		BNC female	
Level		TTL	
USB			
USB Host			
Connector		A Plug	

Protocol	USB 2.0 (Host End)
USB Device	
Connector	Mini
Protocol	2.0 Version
Display	
Type	TFT LCD
Resolution	1024*768
Size	8 inches
Color	65536
Remote Control	
USB	USB TMC
LAN	10/100 Base, RJ-45
Mass Memory	
Mass Memory	Internal Storage 256M Bytes
Temperature	
Operating Temperature Range	0 °C to 40 °C
Storage Temperature Range	-20 °C to 60 °C
Appearance	
Dimensions	265 mm (W) × 190 mm (H) × 58 mm (D)
Weight	Approx. 2.5 kg (without package)

7. Troubleshooting

Typical issues that may occur when using your spectrum analyzer:

- Power on malfunction
- No signal display
- Wrong measurement results or poor frequency or amplitude precision.

1. Power on malfunction

Power on malfunction can include a situation where the screen is still dark (no display) after switch on.

If the screen is still dark after power on, please check:

- 1) If the power supply has been connected correctly and if the power supply voltage range is within the specification.
- 2) If the power switch has been turned on.

2. No signal display

If there is no signal display at any wave band. Please try the following: set a signal generator at 30 MHz frequency and -10 dBm power and connect it to the spectrum analyzer RF input connector. If there is still no signal display, there may be a problem with the spectrum analyzer hardware circuit. Please contact OWON for service.

3. Wrong measurement results or poor signal frequency precision

If the display contents shake a lot or the frequency readout exceeds the error range during measurements, check if the signal source is stable. If so, check if spectrum analyzer reference is precise. Select internal or external frequency reference according to measurement conditions: press **FREQ** bottom softkey → [**Freq Ref Int Ext**]. If the frequency is still not precise, then the spectrum analyzer LO has lost its phase lock, please contact OWON for service.

4. Wrong measurement results or poor readout amplitude precision

If signal amplitude readout is not precise, perform a calibration. If amplitude readout is still not precise, then it may be a problem with internal circuit, please contact OWON for service.

8. Appendix

Appendix A: Enclosure

(The accessories subject to final delivery.)

Standard Accessories



Power Cord



CD Rom



Quick Guide



USB Cable



AC-DC Adapter



Metal Case

Options



N-N Cable



N-SMA Cable



SMA-SMA Cable



SMA Adaptor



N-SMA Adaptor



Near Field Probe includes: Four near-field probes, N-SMA adaptor, SMA-SMA cable (Frequency range: 30 MHz – 3 GHz)



Soft Carrying Case

Appendix B: General Care and Cleaning

General Care

Do not store or leave the instrument where the liquid crystal display could be exposed to direct sunlight for long periods of time.

Caution: To avoid any damage to the instrument or probes, do not expose it to any sprays, liquids, or solvents.

Cleaning

Inspect the instrument and probes as often as operating conditions require.

To clean the instrument exterior, perform the following steps:

Wipe the dust from the instrument surface with a soft cloth. Take care not to scratch the transparent LCD protection screen when cleaning.



WARNING

Before reapplying power, ensure that the instrument is completely dry, avoiding any electric shock or electrical short circuit resulting from moisture.

Appendix C: USB Disk Requirements

USB disk requirements:

Max capacity 4G, NTFS file system is not supported.

If the USB disk doesn't work properly, format your USB disk and then try again.

Appendix D: PC Software Requirements

The PC software support Windows 10 \ Windows 8 \ Windows 7 \ Windows Vista \ Windows 2000.

The PC software does not support Windows XP.