

VSM101

Accelerometer

VIBRATION SENSOR

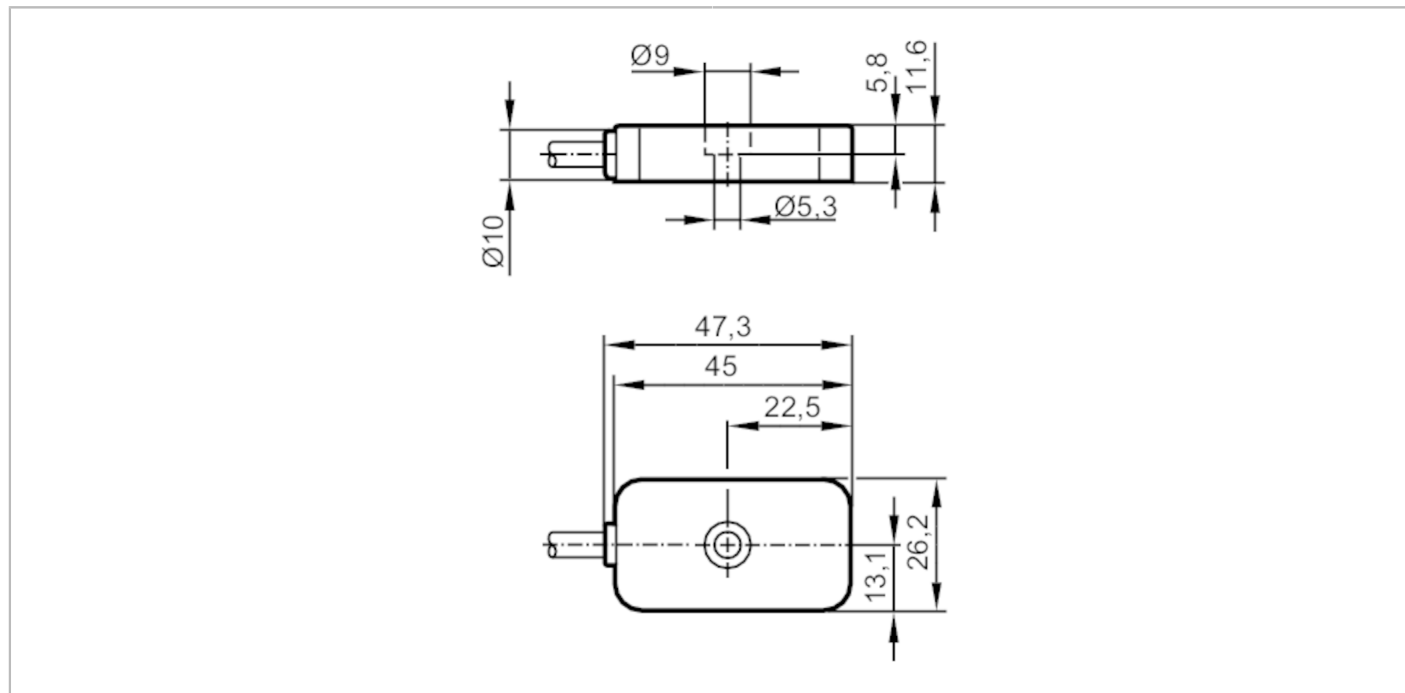

Product characteristics		
Measuring range of vibration	[g]	-40...40
Frequency range	[Hz]	0...4500
Measuring principle		capacitive
Application		
System		screened cable; Drag chain suitability
Electrical data		
Bias voltage DC	[V]	11...16
Operating current	[mA]	4...6
Min. insulation resistance	[MΩ]	100; (500 V DC)
Protection class		III
Reverse polarity protection		yes
Type of sensor		Microelectromechanical system (MEMS)
Measuring/setting range		
Measuring range of vibration	[g]	-40...40
Frequency range	[Hz]	0...4500
Measuring principle		capacitive
Max. transverse sensitivity	[%]	5
Number of measurement axes		3
Accuracy / deviations		
Accuracy		0...3 kHz: +/- 10 % 3...4.5 kHz: 3 dB
Measuring sensitivity		100 mV/g
Linearity deviation		2

VSM101



Accelerometer

VIBRATION SENSOR

[% of the span]

Operating conditions

Ambient temperature	[°C]	-30...85
Storage temperature	[°C]	-30...100
Protection		IP 67; IP 68; IP 69K

Tests / approvals

EMC	DIN EN 61000-6-2	
	DIN EN 61000-6-3	
Shock resistance	DIN EN 60068-2-27	50 g 11 ms
Vibration resistance	DIN EN 60068-2-6	20 g / 10...3000 Hz
MTTF	[years]	529

Mechanical data

Weight	[g]	187.2
Type of mounting		mounting screw
Dimensions	[mm]	26.2 x 47.3 x 11.6
Material		housing: stainless steel (1.4404 / 444)
Tightening torque	[Nm]	3.5
Drag chain suitability		yes
Drag chain suitability	Bending radius for flexible applications	min. 10 x cable diameter
	Bending radius for fixed installation	min. 4 x cable diameter

Accessories

Items supplied	socket head screw: 1 x M5 x 12
----------------	--------------------------------

Remarks

Pack quantity	1 pcs.
---------------	--------

Electrical connection

Cable: 3 m, PUR, Ø 4.9 mm, screened; Maximum cable length: 250 m; screen (connected to the housing); 5 x 0.14 mm²

brown IEPE X
white IEPE Z
blue GND
black self-test
grey IEPE Y
yellow screen