

VSA204

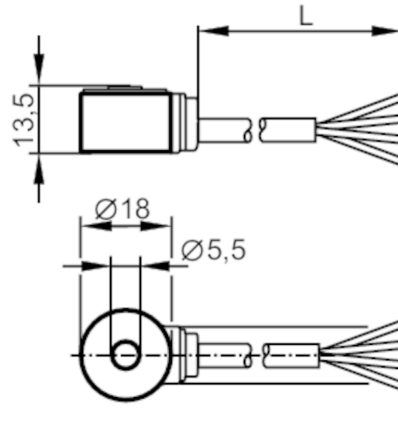

Accelerometer

VIBRATION SENSOR



Product characteristics

Measuring range of vibration	[g]	-150...150
Frequency range	[Hz]	1...10000
Measuring principle		capacitive

Application

System	screened cable; Drag chain suitability
Design	for connection to external diagnostic electronics VSE
Application	vibration detection

Electrical data

Operating voltage	[V]	7.2...10.8 DC
Current consumption	[mA]	< 15
Min. insulation resistance	[MΩ]	100; (500 V DC)
Protection class		III
Reverse polarity protection		yes
Type of sensor		Microelectromechanical system (MEMS)

Outputs

Analog current output	[mA]	0...10
Max. load	[Ω]	300

Measuring/setting range

Measuring range of vibration	[g]	-150...150
Frequency range	[Hz]	1...10000
Measuring principle		capacitive
Sensitivity	[μA/g]	35.5
Number of measurement axes		1

Accuracy / deviations

Linearity deviation		0,2 %
---------------------	--	-------

VSA204



Accelerometer

VIBRATION SENSOR

Operating conditions		
Ambient temperature [°C]	-20...80	
Storage temperature [°C]	-20...80	
Max. relative air humidity [%]	80; (40 °C: 50 % non condensing)	
Protection	IP 67	
Tests / approvals		
EMC	EN 61000-6-2	
	EN 61000-6-3	
Shock resistance	DIN EN 60068-2-27 50 g 11 ms	
Vibration resistance	DIN EN 60068-2-6 20 g / 10 ... 2000 Hz	
MTTF [years]	2104	
UL approval	Ta	80 °C
	Enclosure type	Type 1
	voltage supply	Limited Voltage/Current
	File number UL	E251902
Mechanical data		
Weight [g]	114.3	
Type of mounting	mounting screw	
Material	housing: stainless steel (1.4404 / 316L)	
Tightening torque [Nm]	5	
Mechanische Überlastfestigkeit [g]	500	
Drag chain suitability	yes	
Drag chain suitability	Bending radius for fixed installation	: min. 4 x cable diameter
	Bending radius for flexible applications	: min. 15 x cable diameter
Accessories		
Items supplied	head cap screw: 1 x M5 x 20, Torx 15	
Remarks		
Pack quantity	1 pcs.	
Electrical connection		
Cable: 3 m, PUR, Ø 4 mm, screened; Maximum cable length: 250 m; drain wire applied to the housing; 4 x 0.14 mm ²		
blue	GND	
black	test	
brown	L+	
white	Out	
screen	drain wire	