

TN2445

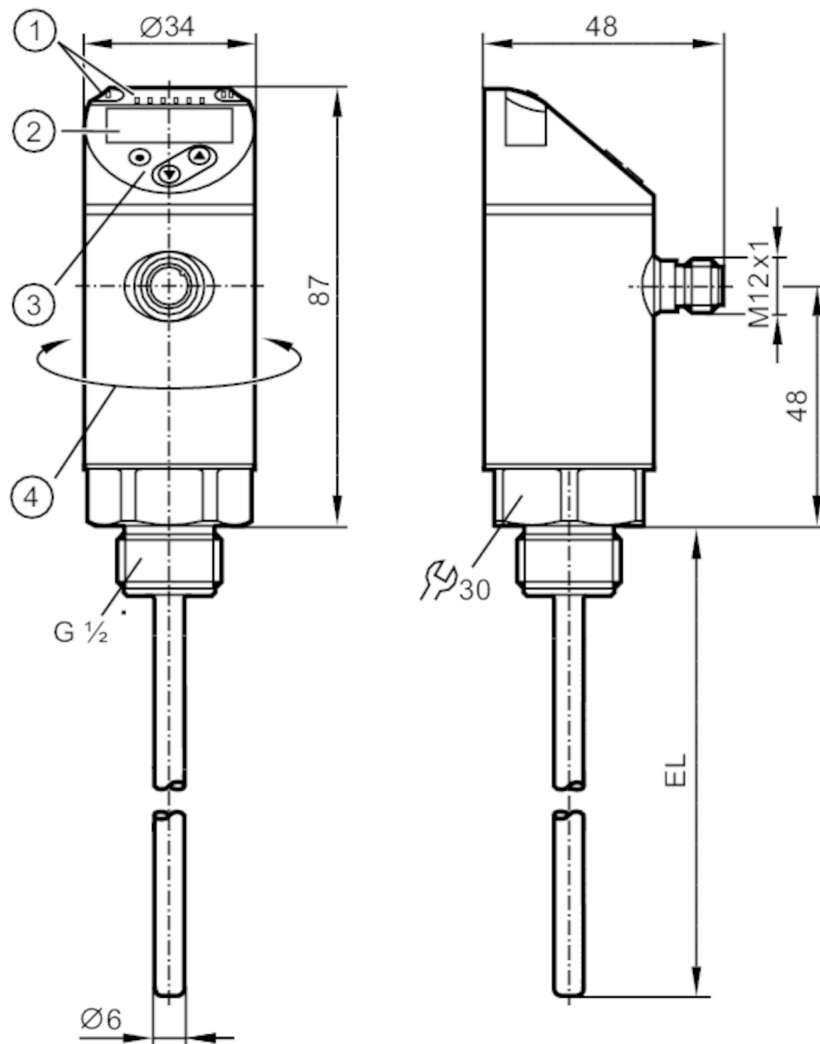

Temperature sensor with display

TN-150KLBM12-MFRKG/US/ IV



- 1 LEDs Display unit / Switching status
- 2 alphanumeric display 4-digit red/green
- 3 Programming buttons
- 4 upper part of the housing can be rotated 345°



Product characteristics

Number of inputs and outputs	Number of digital outputs: 2; Number of analog outputs: 1	
Measuring range	-50...150 °C	-58...302 °F
Communication interface	IO-Link	
Process connection	threaded connection G 1/2	
Installation length EL [mm]	150	

Application

System	gold-plated contacts
Measuring element	1 x Pt 1000; (to DIN EN 60751, class A)
Media	liquids and gases
Pressure rating [bar]	250

TN2445



Temperature sensor with display

TN-150KLBM12-MFRKG/US/ IV

Electrical data		
Operating voltage	[V]	18...32 DC; (cULus - Class 2 source required)
Current consumption	[mA]	< 50
Protection class		III
Reverse polarity protection		yes
Power-on delay time	[s]	1
Integrated watchdog		yes
Inputs / outputs		
Number of inputs and outputs		Number of digital outputs: 2; Number of analog outputs: 1
Outputs		
Total number of outputs		2
Output signal		switching signal; analog signal; IO-Link; (configurable)
Electrical design		PNP/NPN
Number of digital outputs		2
Output function		normally open / closed; (configurable)
Max. voltage drop switching output DC	[V]	2.5
Permanent current rating of switching output DC	[mA]	250
Number of analog outputs		1
Analog current output	[mA]	4...20
Max. load	[Ω]	500
Analog voltage output	[V]	0...10
Min. load resistance	[Ω]	2000
Short-circuit protection		yes
Type of short-circuit protection		yes (non-latching)
Overload protection		yes
Measuring/setting range		
Measuring range		-50...150 °C -58...302 °F
Factory setting		-50...150 °C
Set point SP		-49.8...150 °C -57.6...302 °F
Reset point rP		-50...149.8 °C -58...301.6 °F
Analog start point		-50...145 °C -58...293 °F
Analog end point		-45...150 °C -49...302 °F
In steps of		0.1 °C 0.1 °F
Resolution		
Resolution of switching output	[K]	0.1
Resolution of analog output	[K]	current output: MS / 4096; voltage output: MS / 3561
Resolution of display	[K]	0.1
Accuracy / deviations		
Switch point accuracy	[K]	± 0,3 + (± 0,1 % MS)
Precision analog output	[K]	± 0,3 + (± 0,1 % MS)
Display accuracy	[K]	± 0,3 + (± 0,1 % MS)

TN2445



Temperature sensor with display

TN-150KLBM12-MFRKG/US/ IV

Temperature coefficient [% of the span / 10 K]	0,1; (In case of deviation from the reference condition $25 \pm 5 \text{ }^\circ\text{C}$)	
Reaction times		
Dynamic response T05 / T09 [s]	1 / 3; (according to DIN EN 60751)	
Software / programming		
Parameter setting options	hysteresis / window; normally open / closed; switching logic; switch-on/switch-off delay; Damping; Display unit; current/voltage output	
Interfaces		
Communication interface	IO-Link	
Transmission type	COM2 (38,4 kBaud)	
IO-Link revision	1.1	
Operating conditions		
Ambient temperature [°C]	-25...80	
Storage temperature [°C]	-40...100	
Protection	IP 67	
Tests / approvals		
EMC	DIN EN 61000-6-2	
	DIN EN 61000-6-3	
Shock resistance	DIN IEC 68-2-27	50 g (11 ms)
Vibration resistance	DIN EN 60068-2-6	20 g (10...2000 Hz)
MTTF [years]	207	
UL approval	UL approval number	K015
Mechanical data		
Weight [g]	311	
Material	stainless steel (1.4404 / 316L); PBT+PC-GF30; PBT-GF20; PC	
Materials (wetted parts)	stainless steel (1.4404 / 316L); O-ring: FKM	
Tightening torque [Nm]	45	
Process connection	threaded connection G 1/2	
Installation length EL [mm]	150	
Displays / operating elements		
Display	Display unit	2 x LED, green
	Switching status	2 x LED, yellow
	Measured values	alphanumeric display, red/green 4-digit
Remarks		
Remarks	MS = set measuring span The values for accuracy apply to flowing water.	
Pack quantity	1 pcs.	

TN2445



Temperature sensor with display

TN-150KLBM12-MFRKG/US/ IV

Electrical connection

Connector: 1 x M12; coding: A; Contacts: gold-plated



Connection

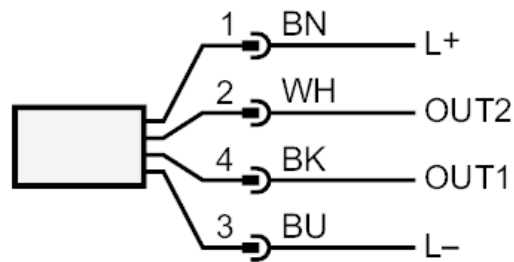

OUT1: Switching output / IO-Link
OUT2: Switching output / analog output
Colors to DIN EN 60947-5-2

Core colors :

BK = black
BN = brown
BU = blue
WH = white