

TD2907

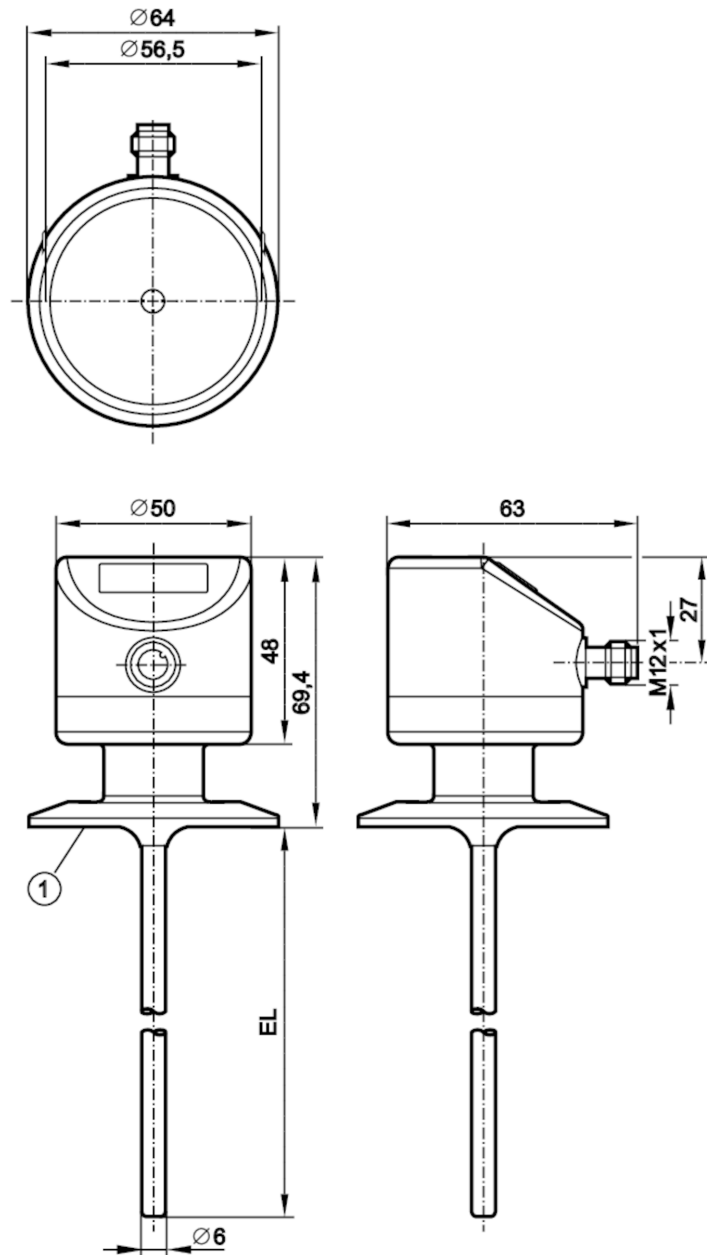

Temperature Transmitter with Display

TD-030CFEC02-A-ZVG/US



1 2" Clamp ISO 2852
EL = Installation length



EC 1935/2004 EHEDG Certified



Product characteristics

Number of inputs and outputs	Number of analog outputs: 1	
Measuring range	-50...150 °C	-58...302 °F
Communication interface	IO-Link	
Process connection	Clamp DN50 (2") DIN 32676 (ISO 2852)	
Installation length EL [mm]	30	

Application

Measuring element	1 x Pt 1000; (to DIN EN 60751, class A)
Media	liquids and gases

TD2907



Temperature Transmitter with Display

TD-030CFEC02-A-ZVG/US

Pressure rating	[bar]	100
Vacuum resistance	[mbar]	-1000
Electrical data		
Operating voltage	[V]	18...32 DC; (cULus - Class 2 source required)
Current consumption	[mA]	< 50
Protection class		III
Reverse polarity protection		yes
Power-on delay time	[s]	2
Inputs / outputs		
Number of inputs and outputs		Number of analog outputs: 1
Outputs		
Total number of outputs		1
Output signal		analog signal; IO-Link; (configurable)
Number of analog outputs		1
Analog current output	[mA]	4...20
Max. load	[Ω]	300
Short-circuit protection		yes
Overload protection		yes
Measuring/setting range		
Measuring range		-50...150 °C -58...302 °F
Factory setting		0...100 °C
Resolution		
Resolution of analog output	[K]	0.04
Resolution of display	[K]	0.1
Accuracy / deviations		
Precision analog output	[K]	± 0,3 + (± 0,1 % MS)
Temperature coefficient [% of the span / 10 K]		0,1; (In case of deviation from the reference condition 25 °C)
Reaction times		
Dynamic response T05 / T09	[s]	1 / 3
Interfaces		
Communication interface		IO-Link
Transmission type		COM2 (38,4 kBaud)
IO-Link revision		1.1
Operating conditions		
Ambient temperature	[°C]	-25...80
Storage temperature	[°C]	-40...100
Protection		IP 67; IP 68; IP 69K
Tests / approvals		
EMC	DIN EN 61000-6-2	
	DIN EN 61000-6-3	
Shock resistance	DIN IEC 68-2-27	50 g (11 ms)
Vibration resistance	DIN IEC 68-2-6	10 g (10...2000 Hz)

TD2907



Temperature Transmitter with Display

TD-030CFEC02-A-ZVG/US

MTTF	[years]	405
Note on approval	Factory certificate available as download at www.factory-certificate.ifm	
UL approval	UL approval number	K001

Mechanical data		
Weight	[g]	378.75
Material	stainless steel (1.4404 / 316L); PEI; FKM	
Materials (wetted parts)	stainless steel (1.4404 / 316L) electropolished	
Process connection	Clamp DN50 (2") DIN 32676 (ISO 2852)	
Surface characteristics Ra/Rz of the wetted parts	Ra: < 0.8	
Probe diameter	[mm]	6
Installation length EL	[mm]	30

Displays / operating elements		
Display	7-segment LED display, 4-digit	
	Display unit / status, °C / °F	

Remarks		
Remarks	MS = set measuring span The values for accuracy apply to flowing water.	
Pack quantity	1 pcs.	

Electrical connection

Connector: 1 x M12; coding: A



Connection

