

TD2241

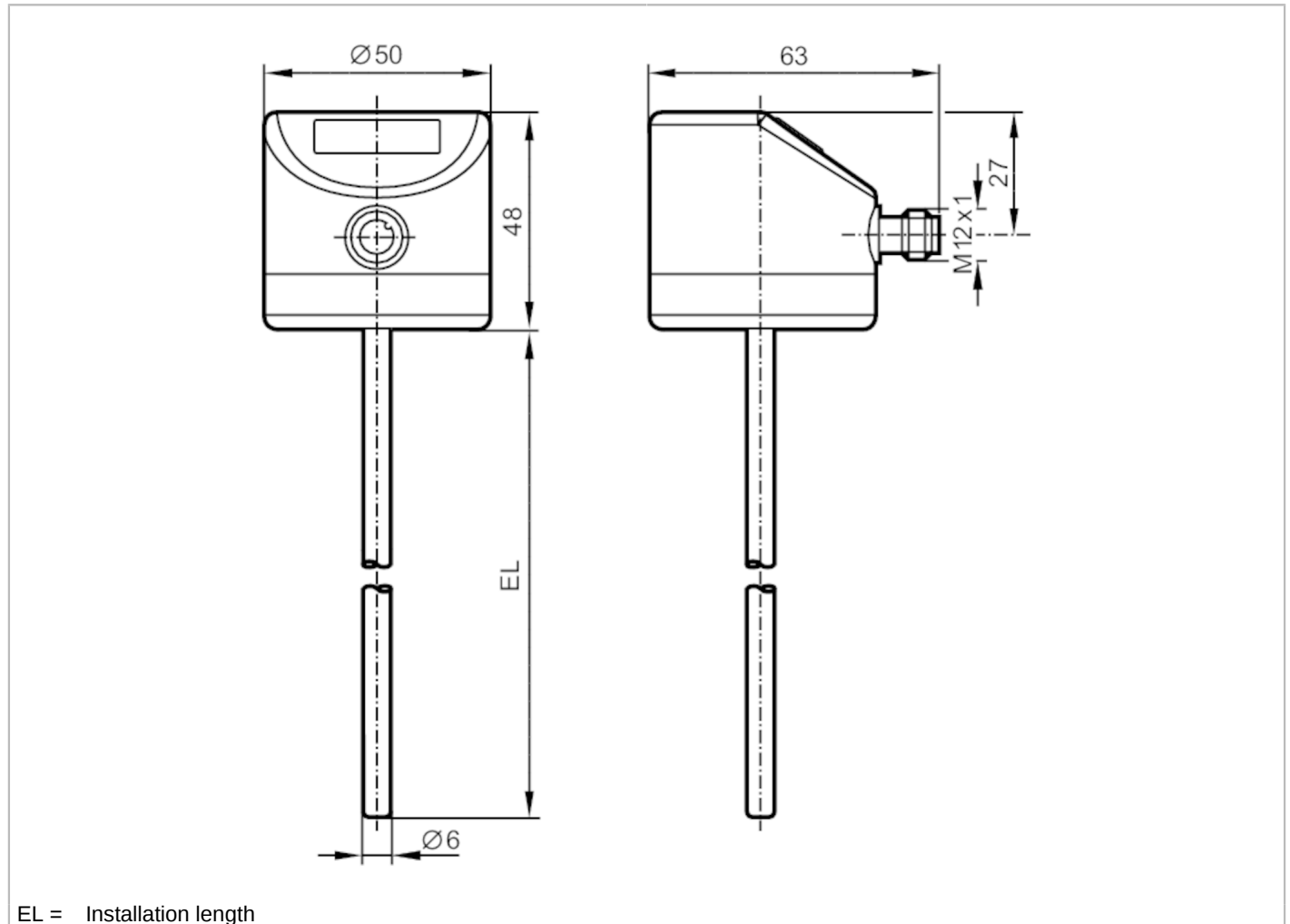

Temperature Transmitter with Display

TD-150CFED06-A-ZVG/US



EL = Installation length



Product characteristics	
Number of inputs and outputs	Number of analog outputs: 1
Measuring range	-50...150 °C -58...302 °F
Communication interface	IO-Link
Process connection	Ø 6 mm
Installation length EL [mm]	150
Application	
Measuring element	1 x Pt 1000; (to DIN EN 60751, class A)
Media	liquids and gases
Pressure rating [bar]	160
Vacuum resistance [mbar]	-1000
Electrical data	
Operating voltage [V]	18...32 DC; (cULus - Class 2 source required)
Current consumption [mA]	< 50
Protection class	III
Reverse polarity protection	yes
Power-on delay time [s]	2

TD2241



Temperature Transmitter with Display

TD-150CFED06-A-ZVG/US

Inputs / outputs	
Number of inputs and outputs	Number of analog outputs: 1
Outputs	
Total number of outputs	1
Output signal	analog signal; IO-Link; (configurable)
Number of analog outputs	1
Analog current output [mA]	4...20
Max. load [Ω]	300
Short-circuit protection	yes
Overload protection	yes
Measuring/setting range	
Measuring range	-50...150 °C -58...302 °F
Factory setting	-10...150 °C
Resolution	
Resolution of analog output [K]	0.04
Resolution of display [K]	0.1
Accuracy / deviations	
Precision analog output [K]	$\pm 0,3 + (\pm 0,1 \% MS)$
Temperature coefficient [% of the span / 10 K]	0,1; (In case of deviation from the reference condition 25 °C)
Reaction times	
Dynamic response T05 / T09 [s]	1 / 3
Interfaces	
Communication interface	IO-Link
Transmission type	COM2 (38,4 kBaud)
IO-Link revision	1.1
Operating conditions	
Ambient temperature [°C]	-25...80
Storage temperature [°C]	-40...100
Protection	IP 67; IP 68; IP 69K
Tests / approvals	
EMC	DIN EN 61000-6-2 DIN EN 61000-6-3
Shock resistance	DIN IEC 68-2-27 50 g (11 ms)
Vibration resistance	DIN IEC 68-2-6 10 g (10...2000 Hz)
MTTF [years]	407
Note on approval	Factory certificate available as download at www.factory-certificate.ifm
UL approval	UL approval number K001
Mechanical data	
Weight [g]	340.5
Dimensions [mm]	$\varnothing 6$
Material	stainless steel (1.4404 / 316L); PEI; FKM
Materials (wetted parts)	stainless steel (1.4404 / 316L) electropolished

TD2241



Temperature Transmitter with Display

TD-150CFED06-A-ZVG/US

Process connection		Ø 6 mm
Surface characteristics Ra/Rz of the wetted parts		Ra: < 0.8
Probe diameter	[mm]	6
Installation length EL	[mm]	150

Displays / operating elements

Display		7-segment LED display, 4-digit
		Display unit / status, °C / °F

Remarks

Remarks		MS = set measuring span The values for accuracy apply to flowing water.
Pack quantity		1 pcs.

Electrical connection

Connector: 1 x M12; coding: A



Connection

