

# TD2237

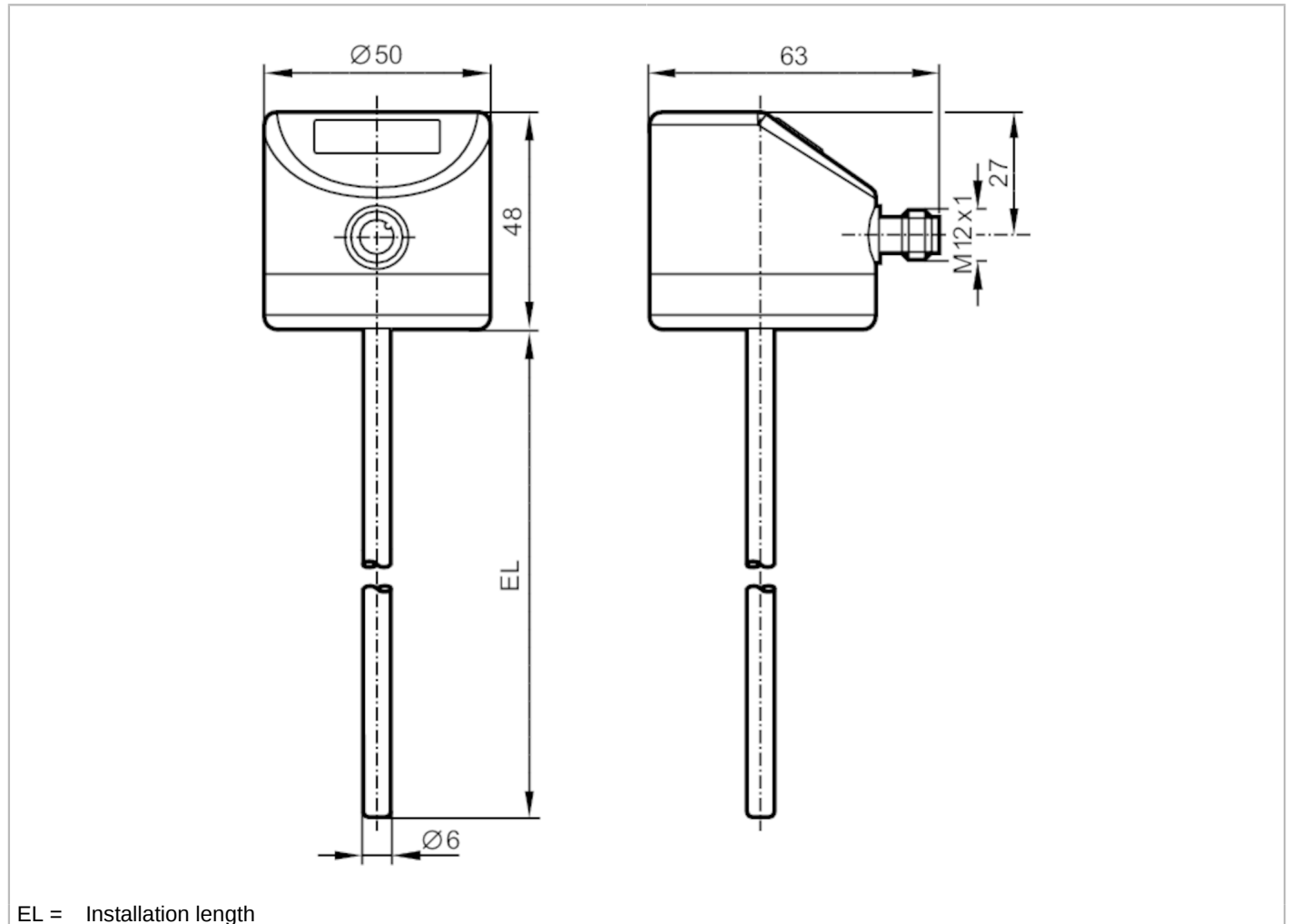

## Temperature Transmitter with Display

TD-100CFED06-A-ZVG/US



EL = Installation length



Product characteristics	
Number of inputs and outputs	Number of analog outputs: 1
Measuring range	-50...150 °C      -58...302 °F
Communication interface	IO-Link
Process connection	Ø 6 mm
Installation length EL [mm]	100
Application	
Measuring element	1 x Pt 1000; (to DIN EN 60751, class A)
Media	liquids and gases
Pressure rating [bar]	160
Vacuum resistance [mbar]	-1000
Electrical data	
Operating voltage [V]	18...32 DC; (cULus - Class 2 source required)
Current consumption [mA]	< 50
Protection class	III
Reverse polarity protection	yes
Power-on delay time [s]	2



## Temperature Transmitter with Display

TD-100CFED06-A-ZVG/US

Inputs / outputs		
Number of inputs and outputs	Number of analog outputs: 1	
Outputs		
Total number of outputs	1	
Output signal	analog signal; IO-Link; (configurable)	
Number of analog outputs	1	
Analog current output [mA]	4...20	
Max. load [ $\Omega$ ]	300	
Short-circuit protection	yes	
Overload protection	yes	
Measuring/setting range		
Measuring range	-50...150 °C	-58...302 °F
Factory setting	0...100 °C	
Resolution		
Resolution of analog output [K]	0.04	
Resolution of display [K]	0.1	
Accuracy / deviations		
Precision analog output [K]	$\pm 0,3 + (\pm 0,1 \% MS)$	
Temperature coefficient [% of the span / 10 K]	0,1; (In case of deviation from the reference condition 25 °C)	
Reaction times		
Dynamic response T05 / T09 [s]	1 / 3	
Interfaces		
Communication interface	IO-Link	
Transmission type	COM2 (38,4 kBaud)	
IO-Link revision	1.1	
Operating conditions		
Ambient temperature [°C]	-25...80	
Storage temperature [°C]	-40...100	
Protection	IP 67; IP 68; IP 69K	
Tests / approvals		
EMC	DIN EN 61000-6-2	
	DIN EN 61000-6-3	
Shock resistance	DIN IEC 68-2-27	50 g (11 ms)
Vibration resistance	DIN IEC 68-2-6	10 g (10...2000 Hz)
MTTF [years]	407	
Note on approval	Factory certificate available as download at <a href="http://www.factory-certificate.ifm">www.factory-certificate.ifm</a>	
UL approval	UL approval number	K001
Mechanical data		
Weight [g]	256	
Dimensions [mm]	Ø 6	
Material	stainless steel (1.4404 / 316L); PEI; FKM	
Materials (wetted parts)	stainless steel (1.4404 / 316L) electropolished	

# TD2237



## Temperature Transmitter with Display

TD-100CFED06-A-ZVG/US

Process connection	Ø 6 mm
Surface characteristics Ra/Rz of the wetted parts	Ra: < 0.8
Probe diameter [mm]	6
Installation length EL [mm]	100

### Displays / operating elements

Display	7-segment LED display, 4-digit
	Display unit / status, °C / °F

### Remarks

Remarks	MS = set measuring span The values for accuracy apply to flowing water.
Pack quantity	1 pcs.

### Electrical connection

Connector: 1 x M12; coding: A



### Connection

