

SF5702

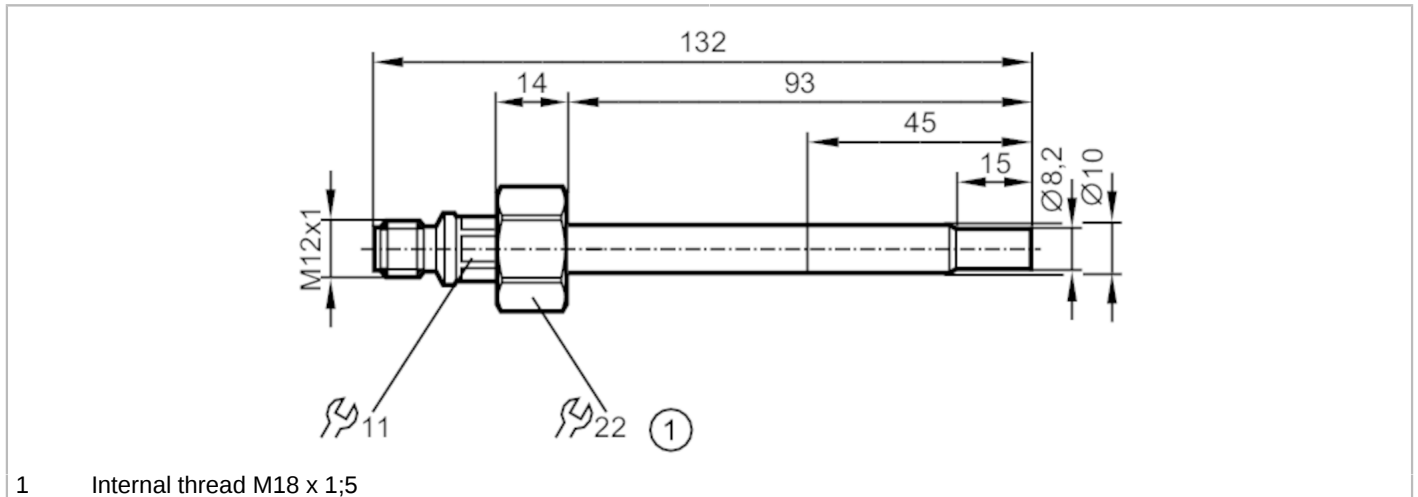

Flow sensor for connection to an evaluation unit

SFD10ADT /US-100



Product characteristics	
Probe length L	[mm] 93
Process connection	M18 x 1,5 Internal thread
Application	
Media	Liquids; Gases; aggressive media
Medium temperature	[°C] -25...80
Pressure rating	[bar] 100
Electrical data	
Connection to control monitor	VS3000
Measuring/setting range	
Probe length L	[mm] 93
Liquids	
Setting range	[cm/s] 3...300
Greatest sensitivity	[cm/s] 3...60
Gases	
Setting range	[cm/s] 200...3000
Greatest sensitivity	[cm/s] 200...800
Accuracy / deviations	
Max. temperature gradient of medium	[K/min] 300
Reaction times	
Response time	[s] 1...10
Operating conditions	
Storage temperature	[°C] -25...80
Protection	IP 67
Tests / approvals	
Shock resistance	DIN IEC 68-2-27 50 g (11 ms)
Vibration resistance	DIN IEC 68-2-6 10 g (55...2000 Hz)
MTTF	[years] 8393.77

SF5702



Flow sensor for connection to an evaluation unit

SFD10ADT /US-100

Mechanical data	
Weight [g]	68
Housing	for adapter
Dimensions [mm]	M18 x 1.5
Thread designation	M18 x 1.5
Material	titanium (3.7035); EPDM; ULTEM
Materials (wetted parts)	titanium (3.7035); O-ring: FKM 80 Shore A
Process connection	M18 x 1,5 Internal thread

Remarks	
Pack quantity	1 pcs.

Electrical connection

Connector: 1 x M12; coding: A; Maximum cable length: 100 m

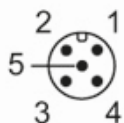

Connection

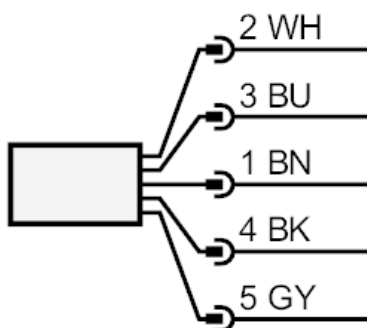

Core colors :
BN = brown
BU = blue
BK = black
WH = white
GY = grey