

SBU625

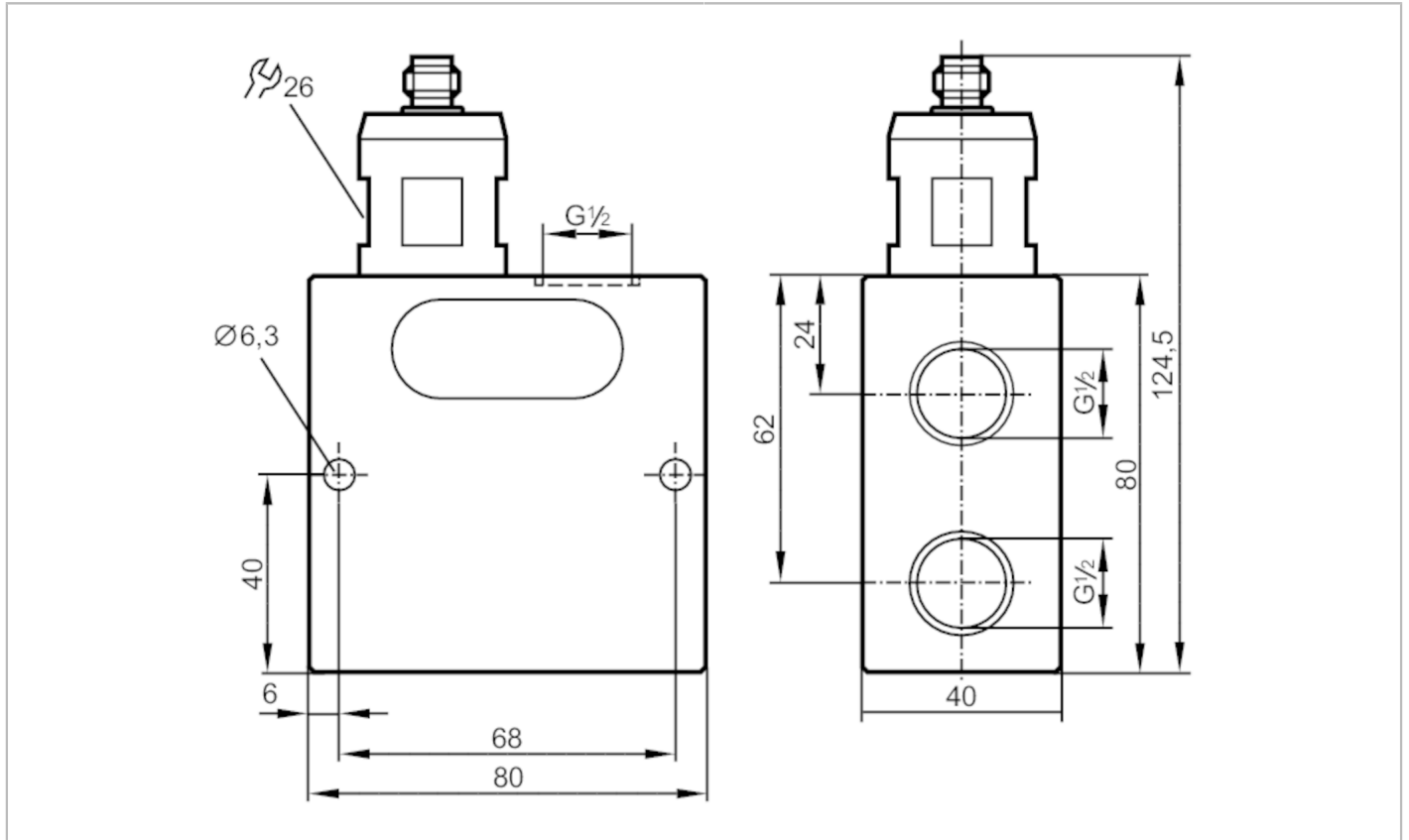

Flow transmitters with fast response time

SBU12DI040KG/US



Product characteristics	
Measuring range	[l/min] 0.3...75
Process connection	G 1/2
Application	
Application	Machine tools; Internal cooling of drill
Media	Liquids; water; glycol solutions; Coolants
Medium temperature	[°C] 0...60
Pressure rating	[bar] 200
Pressure rating	[MPa] 20
Electrical data	
Operating voltage tolerance	[%] -15...10
Operating voltage	[V] 24 DC; (to SELV/PELV)
Current consumption	[mA] 10
Protection class	III
Reverse polarity protection	yes
Outputs	
Output signal	analog signal
Analog voltage output	[V] 0.5...10
Min. load resistance	[Ω] 10000
Short-circuit protection	yes
Overload protection	yes

SBU625



Flow transmitters with fast response time

SBU12DI040KG/US

Measuring/setting range	
Measuring range [l/min]	0.3...75
Flow range [l/min]	75
Accuracy / deviations	
Repeatability [% of the final value]	1
Measuring error [% of the final value]	± 5
Reaction times	
Response time [s]	< 0.01
Operating conditions	
Ambient temperature [°C]	0...60
Storage temperature [°C]	-15...80
Protection	IP 65; IP 67
Tests / approvals	
EMC	DIN EN 61000-6-2 DIN EN 61000-6-3
Shock resistance	DIN EN 60068-2-27 20 g (11 ms)
Vibration resistance	DIN EN 60068-2-6 5 g (10...2000 Hz)
MTTF [years]	15.78
Mechanical data	
Weight [g]	738
Material	aluminum anodized; PA
Materials (wetted parts)	stainless steel (1.4401 / 316); brass; aluminum anodized; PU; O-ring: FKM
Process connection	G 1/2
Switching cycles mechanical	10 million
Accessories	
Items supplied	sealing plug
Remarks	
Remarks	Temperature changes affect the specified standard settings for coolants. For oils, the settings are influenced by temperature and viscosity. Recommendation Use 200 micron filtration All data refer to coolants (20 °C).
Pack quantity	1 pcs.
Electrical connection	
Connector: 1 x M12; coding: A	
	

SBU625



Flow transmitters with fast response time

SBU12DI040KG/US

Connection

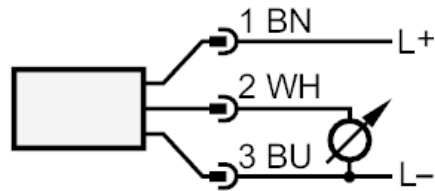

Colors to DIN EN 60947-5-2

Core colors :

BN = brown
BU = blue
WH = white

Diagrams and graphs

