

# OY826S



## Safety light curtain

OYA0760-40-4-18-P-1-B

For 8-wire cordsets the core colors are not standardized.  
Please note the wiring of the sensor and the cordsets (see data sheet).

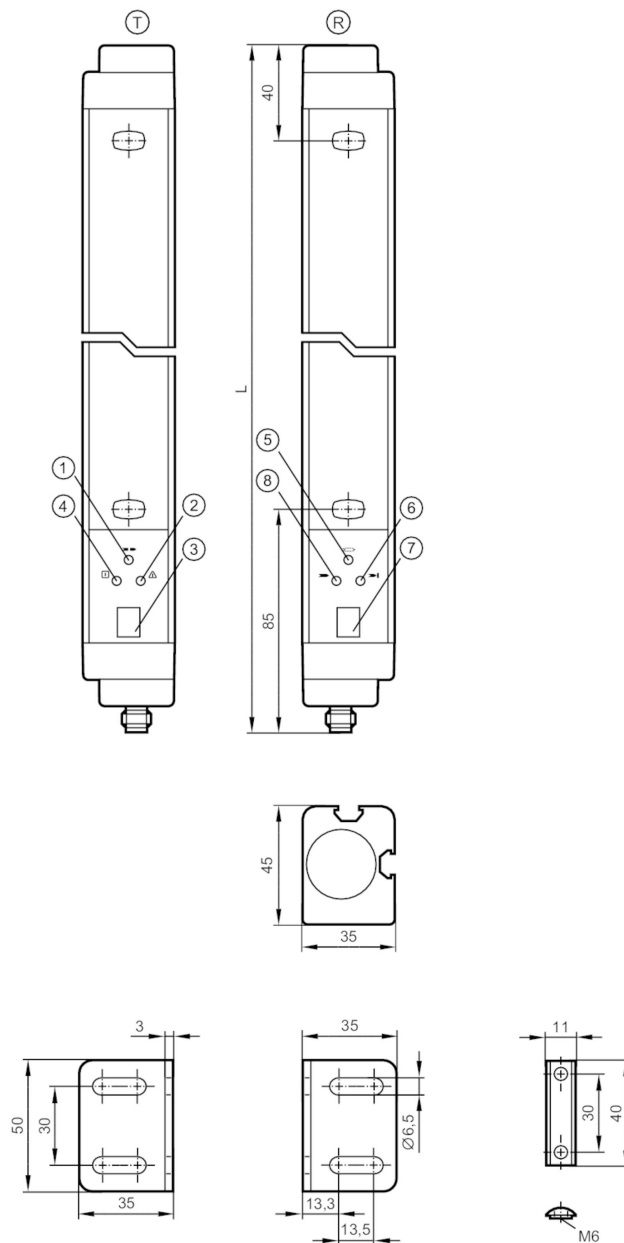

- T transmitter
- R receiver
- 1 LED yellow
- 2 LED red
- 3 7-segment LED display
- 4 LED green
- 5 LED yellow
- 6 LED red
- 7 7-segment LCD display
- 8 LED green



### Product characteristics

Type of light

Infrared light

# OY826S



## Safety light curtain

OYA0760-40-4-18-P-1-B

Electrical design		PNP
Protection		IP 65
<b>Application</b>		
Protective function		Access prevention hand protection
<b>Electrical data</b>		
Operating voltage tolerance [%]		20
Operating voltage [V]		24 DC
Protection class		III
Reverse polarity protection		yes
Power-on delay time [s]		< 18
Type of light		Infrared light
Wave length [nm]		950
<b>Receiver</b>		
Current consumption [mA]		125
<b>Transmitter</b>		
Current consumption [mA]		83
<b>Outputs</b>		
Electrical design		PNP
Number of OSSD outputs		2
Max. current load per OSSD output [mA]		500; (24 V)
Short-circuit protection		yes
<b>Monitoring range</b>		
Protected area height [mm]		760
Resolution (detection capacity d) [mm]		40
Protection area width (low light intensity) [m]		0...6
Protection area width (high light intensity) [m]		3...18
Floating blanking		yes
<b>Reaction times</b>		
Response time [ms]		9.5
<b>Operating conditions</b>		
Applications		Class C to EN 60654-1 weatherproof application
Ambient temperature [°C]		0...55
Max. relative air humidity [%]		95
Protection		IP 65
<b>Tests / approvals</b>		
EMC	IEC 61496-1	
Shock resistance	IEC 61496-1	
Vibration resistance	IEC 61496-1	
<b>Safety classification</b>		
ESPE type (IEC 61496-1)		4

# OY826S

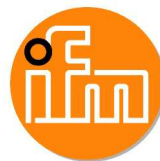

## Safety light curtain

OYA0760-40-4-18-P-1-B

Complies with the requirements		ISO 13849-1: 2015 Category 4, PL e
		IEC 61508 SIL 3
		IEC 62061 SIL 3
Mission time TM	[h]	175200
PFH	[1/h]	1,2E-08

### Mechanical data

Weight	[g]	4800
Dimensions	[mm]	861 x 35 x 45
Material		housing: aluminum; front lens: PC
Length L	[mm]	861

### Displays / operating elements

Display	transmitter	3 x LED
	transmitter	7-segment LCD display
	receiver	3 x LED
	receiver	7-segment LCD display

### Accessories

Items supplied	Assembly angle: 4
	Slot nuts: 4
	screws

### Remarks

Pack quantity	1 pcs.
---------------	--------

### Electrical connection - receiver

Connector: 1 x M12; coding: A; Maximum cable length: 100 m; for wire cross-section 0.34 mm<sup>2</sup>

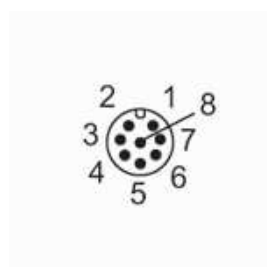

# OY826S



## Safety light curtain

OYA0760-40-4-18-P-1-B

### Connection

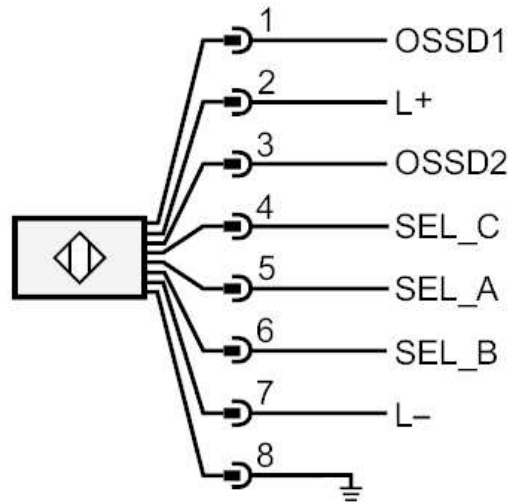

### Electrical connection - transmitter

Connector: 1 x M12; coding: A

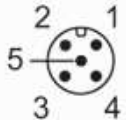

### Connection

