

OY825S



Safety light curtain

OYA0610-40-4-18-P-1-B

For 8-wire cordsets the core colors are not standardized.
Please note the wiring of the sensor and the cordsets (see data sheet).

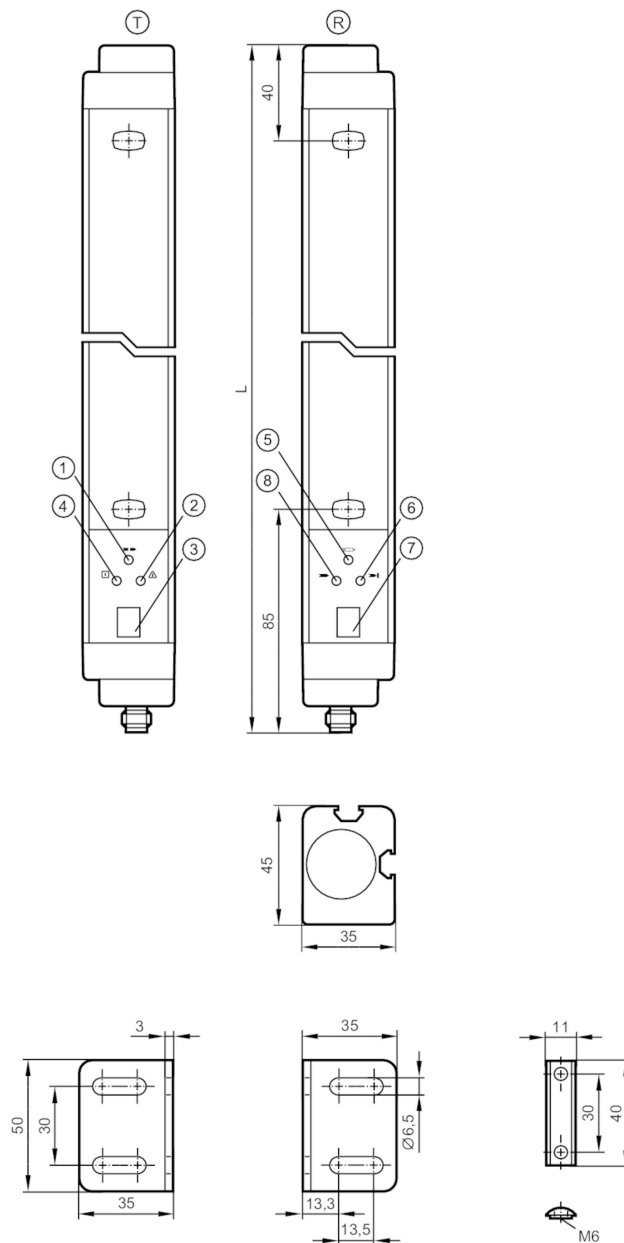

- T transmitter
- R receiver
- 1 LED yellow
- 2 LED red
- 3 7-segment LED display
- 4 LED green
- 5 LED yellow
- 6 LED red
- 7 7-segment LCD display
- 8 LED green



Product characteristics

Type of light

Infrared light

OY825S



Safety light curtain

OYA0610-40-4-18-P-1-B

Electrical design		PNP
Protection		IP 65
Application		
Protective function		Access prevention hand protection
Electrical data		
Operating voltage tolerance [%]		20
Operating voltage [V]		24 DC
Protection class		III
Reverse polarity protection		yes
Power-on delay time [s]		< 18
Type of light		Infrared light
Wave length [nm]		950
Receiver		
Current consumption [mA]		125
Transmitter		
Current consumption [mA]		83
Outputs		
Electrical design		PNP
Number of OSSD outputs		2
Max. current load per OSSD output [mA]		500; (24 V)
Short-circuit protection		yes
Monitoring range		
Protected area height [mm]		610
Resolution (detection capacity d) [mm]		40
Protection area width (low light intensity) [m]		0...6
Protection area width (high light intensity) [m]		3...18
Floating blanking		yes
Reaction times		
Response time [ms]		8.5
Operating conditions		
Applications		Class C to EN 60654-1 weatherproof application
Ambient temperature [°C]		0...55
Max. relative air humidity [%]		95
Protection		IP 65
Tests / approvals		
EMC	IEC 61496-1	
Shock resistance	IEC 61496-1	
Vibration resistance	IEC 61496-1	
Safety classification		
ESPE type (IEC 61496-1)		4

OY825S



Safety light curtain

OYA0610-40-4-18-P-1-B

Complies with the requirements		ISO 13849-1: 2015 Category 4, PL e
		IEC 61508 SIL 3
		IEC 62061 SIL 3
Mission time TM	[h]	175200
PFH	[1/h]	1,2E-08

Mechanical data		
Weight	[g]	3610
Dimensions	[mm]	711 x 35 x 45
Material		housing: aluminum; front lens: PC
Length L	[mm]	711

Displays / operating elements		
Display	transmitter	3 x LED
	transmitter	7-segment LCD display
	receiver	3 x LED
	receiver	7-segment LCD display

Accessories		
Items supplied		Assembly angle: 4
		Slot nuts: 4
		screws

Remarks		
Pack quantity		1 pcs.

Electrical connection - receiver

Connector: 1 x M12; coding: A; Maximum cable length: 100 m; for wire cross-section 0.34 mm²

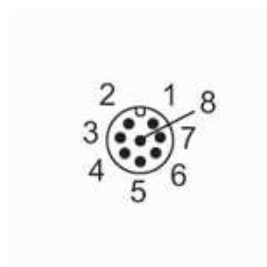

OY825S



Safety light curtain

OYA0610-40-4-18-P-1-B

Connection

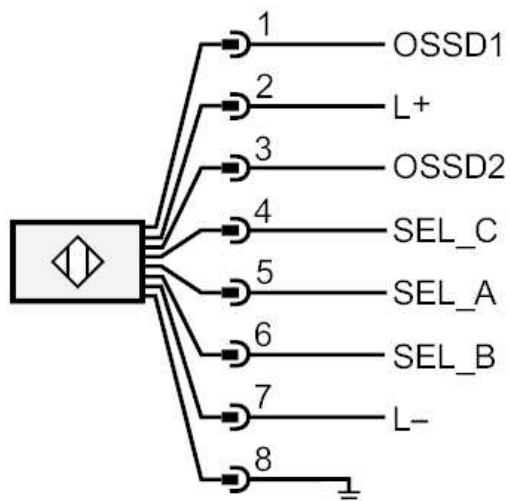

Electrical connection - transmitter

Connector: 1 x M12; coding: A

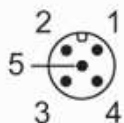

Connection

