

OY511S

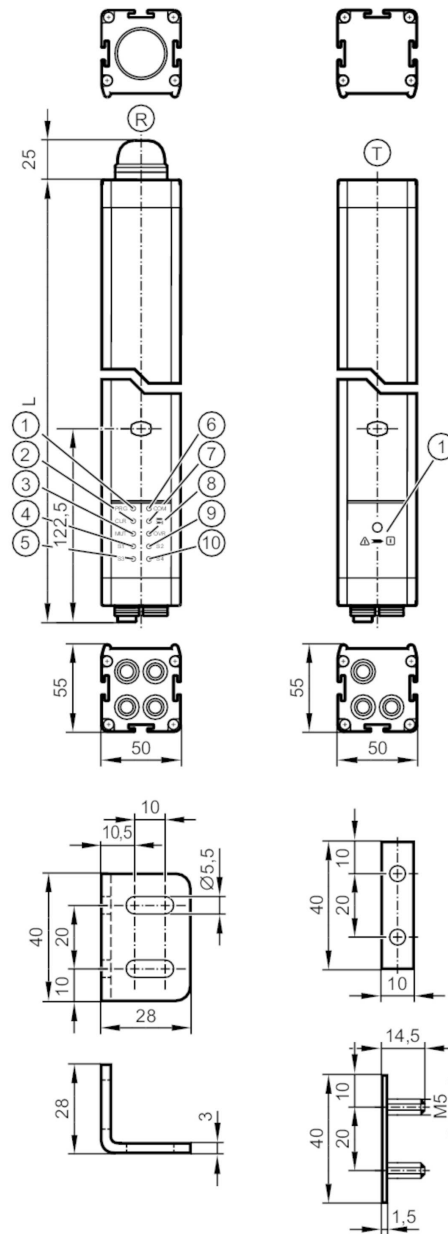

Safety light grids

OYA510-02-4-12-P-4-M



- T transmitter
- 1 LED three-color red / yellow / green
-
- R receiver
- 1 LED yellow
- 2 LED yellow
- 3 LED yellow
- 4 LED yellow
- 5 LED yellow
- 6 LED orange
- 7 LED 2-color red/green
- 8 LED yellow
- 9 LED yellow
- 10 LED yellow



Product characteristics

Type of light

Infrared light



Safety light grids

OYA510-02-4-12-P-4-M

Electrical design		PNP
Protection		IP 65; IP 67
Electrical data		
Operating voltage	[V]	24 DC
Protection class		III
Reverse polarity protection		yes
Power-on delay time	[s]	< 10
Type of light		Infrared light
Wave length	[nm]	950
Receiver		
Current consumption	[mA]	84
Transmitter		
Current consumption	[mA]	42
Outputs		
Electrical design		PNP
Number of OSSD outputs		2
Max. current load per OSSD output	[mA]	300; (24 V)
Short-circuit protection		yes
Monitoring range		
Protected area height	[mm]	510
Number of beams		2
Protection area width (low light intensity)	[m]	0...4
Protection area width (high light intensity)	[m]	3...12
Reaction times		
Response time	[ms]	5.5
Operating conditions		
Applications		Class C to EN 60654-1 weatherproof application
Ambient temperature	[°C]	-30...55
Storage temperature	[°C]	-30...70
Max. relative air humidity	[%]	95; (non condensing)
Protection		IP 65; IP 67
Tests / approvals		
EMC	IEC 61496-1	
Shock resistance	IEC 61496-1	
Vibration resistance	IEC 61496-1	
Safety classification		
ESPE type (IEC 61496-1)		4
Complies with the requirements	ISO 13849-1: 2015 Category 4, PL e	
	IEC 61508 SIL 3	
	IEC 62061 SIL 3	
Mission time TM	[h]	175200

OY511S



Safety light grids

OYA510-02-4-12-P-4-M

PFH	[1/h]	9E-09
-----	-------	-------

Mechanical data

Weight	[g]	4720
Dimensions	[mm]	685 x 50 x 50
Material		housing: aluminum; front lens: PC
Length L	[mm]	685

Displays / operating elements

Display	transmitter	1 x LED
	receiver	10 x LED

Accessories

Items supplied	Assembly angle: 4
	Slot nuts: 4

Remarks

Pack quantity	1 pcs.
---------------	--------

Electrical connection - receiver

Connection

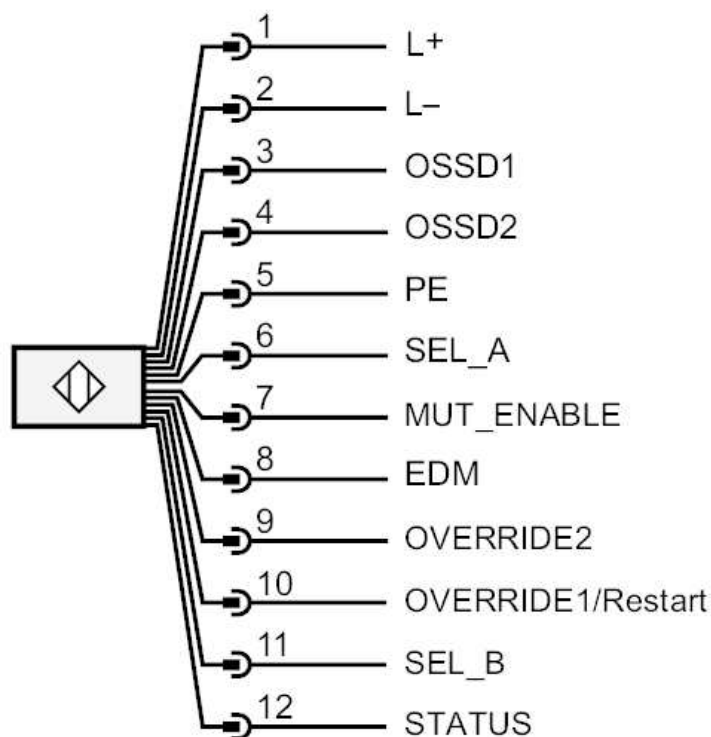

Connector: 1 x M12; Maximum cable length: 100 m; for wire cross-section 1 mm²

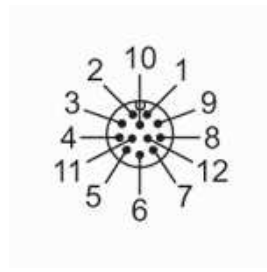

OY511S



Safety light grids

OYA510-02-4-12-P-4-M

Electrical connection - transmitter

Connection

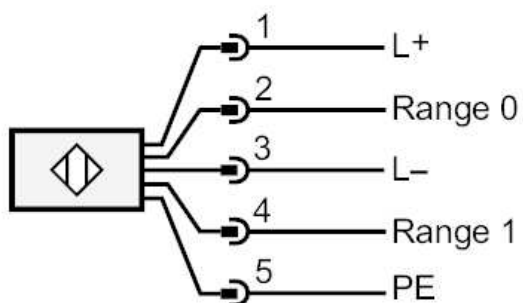

Connector: 1 x M12; coding: A

