

OY044S



Safety light curtain

OYA0610-30-4-12-P-1

For 8-wire cordsets the core colors are not standardized.
Please note the wiring of the sensor and the cordsets (see data sheet).

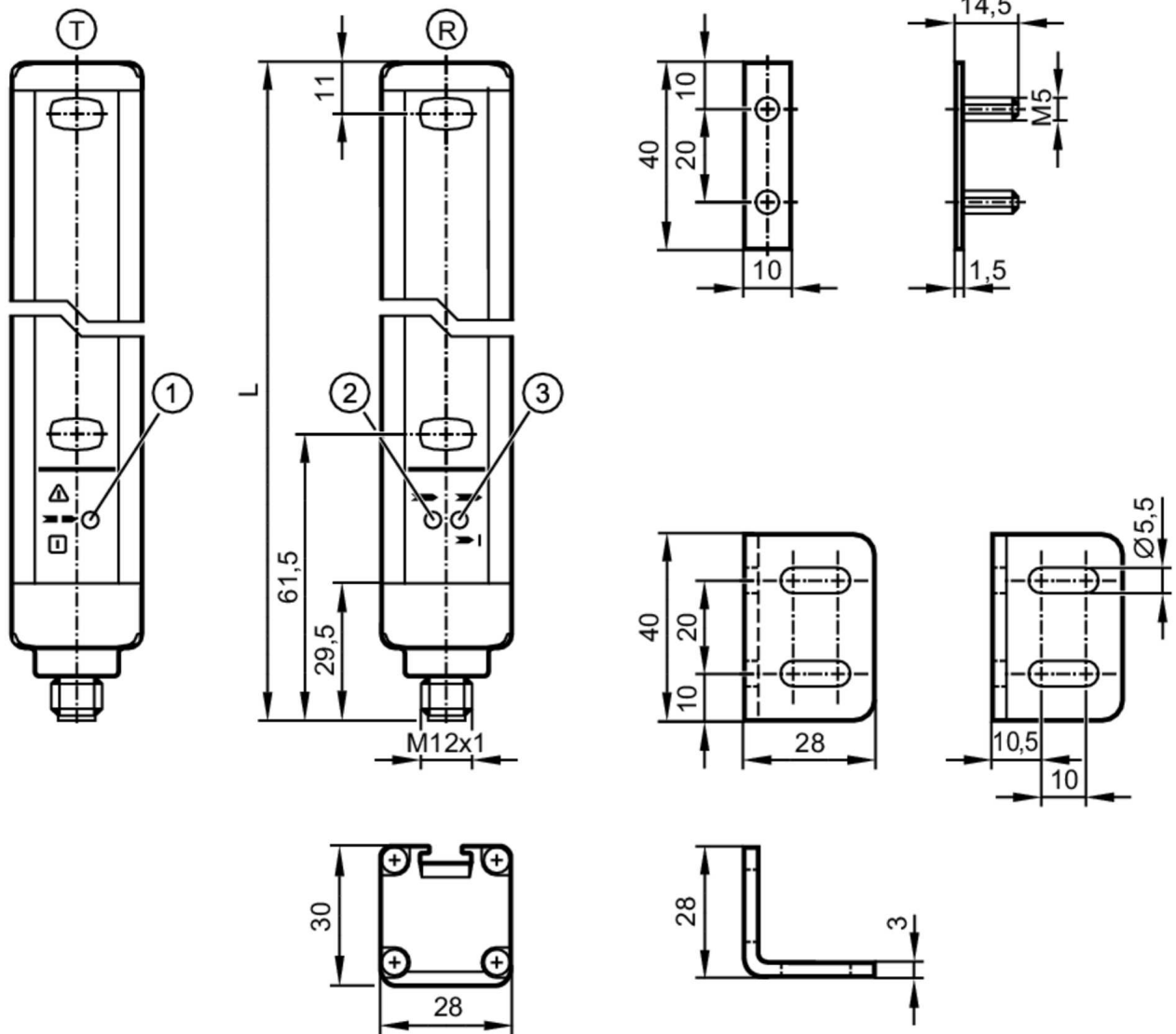

- T transmitter
- R receiver
- 1 LED three-color red / green / orange
- 2 LED yellow
- 3 LED 2-color red/green



Product characteristics

Type of light	Infrared light
Electrical design	PNP
Protection	IP 65; IP 67

Application

Protective function	Access prevention hand protection
---------------------	-----------------------------------



Safety light curtain

OYA0610-30-4-12-P-1

Electrical data		
Operating voltage tolerance	[%]	20
Operating voltage	[V]	24 DC
Protection class		III
Reverse polarity protection		yes
Power-on delay time	[s]	< 2
Type of light		Infrared light
Wave length	[nm]	950
Receiver		
Current consumption	[mA]	83
Transmitter		
Current consumption	[mA]	42
Outputs		
Electrical design		PNP
Number of OSSD outputs		2
Max. current load per OSSD output	[mA]	400; (24 V)
Short-circuit protection		yes
Monitoring range		
Protected area height	[mm]	610
Resolution (detection capacity d)	[mm]	30
Protection area width (low light intensity)	[m]	0...4
Protection area width (high light intensity)	[m]	3...12
Reaction times		
Response time	[ms]	8.5
Operating conditions		
Applications		Class C to EN 60654-1 weatherproof application
Ambient temperature	[°C]	-10...55
Storage temperature	[°C]	-20...70
Max. relative air humidity	[%]	95
Protection		IP 65; IP 67
Tests / approvals		
EMC	IEC 61496-1	
Shock resistance	IEC 61496-1	
Vibration resistance	IEC 61496-1	
Safety classification		
ESPE type (IEC 61496-1)		4
Complies with the requirements		ISO 13849-1: 2015 Category 4, PL e
		IEC 61508 SIL 3
		IEC 62061 SIL 3
Mission time TM	[h]	175200
PFH	[1/h]	1,1E-08

OY044S



Safety light curtain

OYA0610-30-4-12-P-1

Mechanical data

Weight	[g]	2370
Dimensions	[mm]	663 x 28 x 30
Material		housing: aluminum; front lens: PC
Length L	[mm]	663

Displays / operating elements

Display	transmitter	1 x LED
	receiver	2 x LED

Accessories

Items supplied	Assembly angle: 4
	Slot nuts: 4
	Nuts

Remarks

Pack quantity	1 pcs.
---------------	--------

Electrical connection - receiver

Connector: 1 x M12; coding: A; Maximum cable length: 100 m; for wire cross-section 0.34 mm²

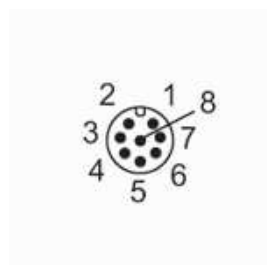

Connection

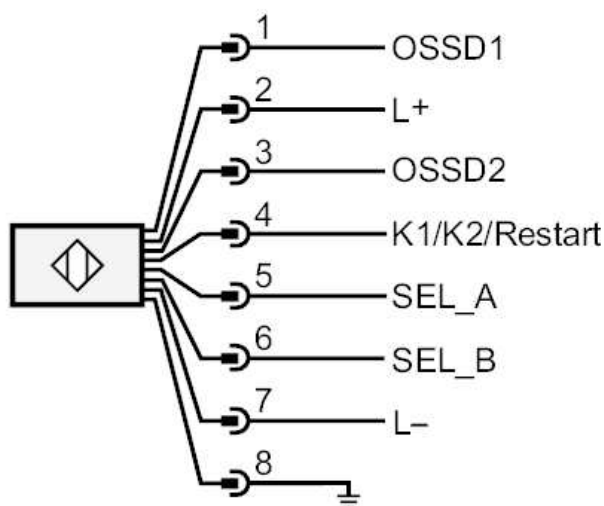

OY044S



Safety light curtain

OYA0610-30-4-12-P-1

Electrical connection - transmitter

Connector: 1 x M12; coding: A

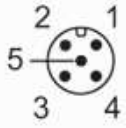

Connection

