

LT8022



Electronic level and temperature sensor

LT0264B-B-00KSPKG/US

For 8-wire cordsets the core colors are not standardized.
Please note the wiring of the sensor and the cordsets (see data sheet).

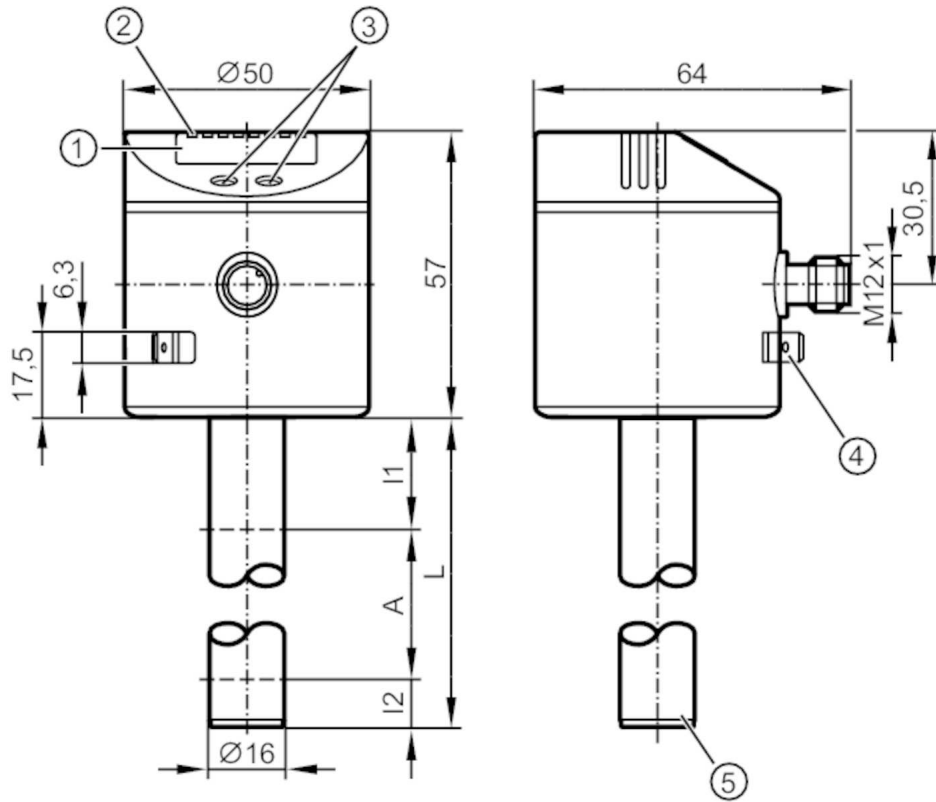

- 1 alphanumeric display 4-digit
- 2 status LEDs
- 3 Programming buttons
- 4 housing connection flat-pin connector 6.3 mm DIN 46244
- 5 Position of the temperature measuring element



Product characteristics

Number of inputs and outputs	Number of digital outputs: 4
Factory setting	2 switching outputs level (OUT1, OUT2); 2 switching outputs temperature (OUT3, OUT4); mineral oils
Probe length L [mm]	264

Application

Media	hydrous coolants; oils; oil-based media; water; media similar to water
Dielectric constant of the medium	> 2
Cannot be used for	extremely conductive media; adhering media; granulates; bulk material; acids; alkali
Tank pressure [bar]	0.5; (when mounting with mounting accessories: E43001 - E43007, E43019)
Coolants	
Medium temperature [°C]	0...35; (with climate tube E43100 35...65 °C)
Oil	
Medium temperature [°C]	0...70

LT8022



Electronic level and temperature sensor

LT0264B-B-00KSPKG/US

Medium temperature short time	[°C]	0...90; (< 1 h)
Water		
Medium temperature	[°C]	0...35; (with climate tube E43100 35...65 °C)
Electrical data		
Operating voltage	[V]	18...30 DC
Current consumption	[mA]	< 50
Protection class		III
Reverse polarity protection		yes
Power-on delay time	[s]	< 3
Measuring principle		capacitive
Inputs / outputs		
Number of inputs and outputs		Number of digital outputs: 4
Outputs		
Total number of outputs		4
Output signal		switching signal; IO-Link
Electrical design		PNP/NPN
Number of digital outputs		4
Output function		normally open / closed; (configurable)
Max. voltage drop switching output DC	[V]	2.5
Permanent current rating of switching output DC	[mA]	200
Short-circuit protection		yes
Type of short-circuit protection		thermal, pulsed
Overload protection		yes
Measuring/setting range		
Factory setting		2 switching outputs level (OUT1, OUT2); 2 switching outputs temperature (OUT3, OUT4); mineral oils
Probe length L	[mm]	264
Active range A	[mm]	195
Inactive range I1 / I2	[mm]	53 / 16
Setting range		
Set point SP	[mm]	25...190
Reset point rP	[mm]	20...195
In steps of	[mm]	5
Reference point OP	[mm]	69 - 82 - 94 - 106 - 118 - 130 - 143 - 155 - 167 - 179 - 191 - 204 - OFF
Hysteresis, OP	[mm]	2
Temperature monitoring		
Measuring range	[°C]	-20...90
Set point SP	[°C]	-19.5...90
Reset point rP	[°C]	-20...89.5
In steps of	[°C]	0.5

LT8022



Electronic level and temperature sensor

LT0264B-B-00KSPKG/US

Resolution of switching output	[K]	0.5
Accuracy / deviations		
Measuring error		± 5
	[% of the final value]	
Repeatability		± 2
Resolution	[mm]	5
Temperature monitoring		
Switch point accuracy	[K]	± 1,5
Resolution	[K]	0.5
Dynamic response T09	[s]	90
Software / programming		
Parameter setting options	hysteresis / window; normally open / closed; SP/rP position; OP position; adjustment OP; medium selection; offset setting; Display unit; process value assignment	
Interfaces		
Communication interface	IO-Link	
Transmission type	COM2 (38,4 kBaud)	
IO-Link revision	1.1	
SDCI standard	IEC 61131-9	
Profiles	Smart Sensor: Process Data Variable; Device Identification, Device Diagnosis	
SIO mode	yes	
Required master port class	A	
Process data analog	4	
Process data binary	4	
Min. process cycle time	[ms]	4.5
Supported DeviceIDs	Type of operation	DeviceID
	default	18
Operating conditions		
Ambient temperature	[°C]	0...60
Storage temperature	[°C]	-25...80
Protection		IP 67
Tests / approvals		
EMC	DIN EN 61000-6-2	
	DIN EN 61000-6-4	
Shock resistance	DIN EN 60068-2-27	15 g (11 ms)
Vibration resistance	DIN EN 60068-2-6	5 g (10...2000 Hz)
MTTF	[years]	224
Mechanical data		
Weight	[g]	290.35
Dimensions	[mm]	Ø 16
Material	stainless steel (1.4301 / 304); stainless steel (1.4404 / 316L); FKM; NBR; PBT; PC; PP; PA; TPV	
Materials (wetted parts)	PP	

LT8022



Electronic level and temperature sensor

LT0264B-B-00KSPKG/US

Displays / operating elements		
Display	Display unit	4 x LED, green (cm, inch, °C, °F)
	Switching status	4 x LED, yellow (OUT4...OUT1)
	Measured values	alphanumeric display, 4-digit
	Parameter setting	alphanumeric display, 4-digit

Remarks	
Pack quantity	1 pcs.

Electrical connection

Connector: 1 x M12; coding: A

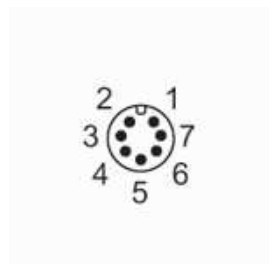

Connection

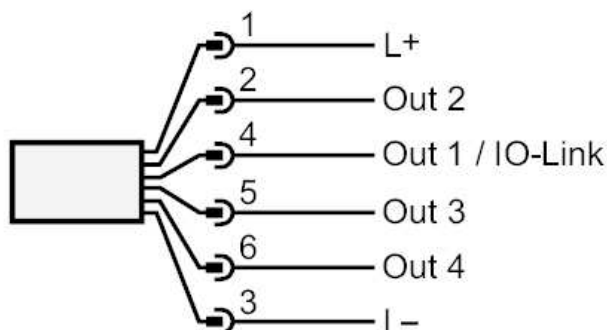

OUT1: Switching output IO-Link
OUT2...4: Switching output