

# FL-600P Floor Box

# FSR Metal Products Group

FL-600P Floor Box



## “TOOL-LESS” HINGED U-ACCESS COVER

The cable access door can be easily removed by lifting the integrated U-Access handle to quickly access the interior compartment, connectors, and cables.

- 11-gauge steel temporary construction cover included
- 11-gauge finished steel cover with choice of carpet edging
- Mitered brass or aluminum carpet edging .5” or .25” high
- Stainless steel compression latches
- Hinged full access door
- Galvanized steel



**Scrub water approved for  
carpet, tile, and wood floors!**

## DESCRIPTION

Our FL-600P floor boxes combine rugged construction and an elegant design for use in carpet, tile, or wood covered floors over poured concrete applications. This makes it the perfect floor box for ballrooms, meeting rooms, public spaces, and high traffic areas. There is ample compartment room to accommodate power, audio, video, telecommunications, and data in one elegant and practical box.

There are a variety of covers to choose from. Options include integrated carpet edging, flat covers for non-carpeted, bare floor applications, and different finishes. The hinged section of the cover allows full access to internal connector plates and stored cables. The hinged cable exit door flips back to allow the cover to remain in place after connections are made and cables are routed through it. The 0.25” and 0.50” raised edge style covers are UL scrub water approved.

The innovation continues to the “transformable” box bottom. The FL-600P’s internal brackets can be arranged to provide numerous options for both high and low voltage standard gang openings making it the most flexible and easiest to install floor box available. Removable center dividers make passing cables through the various compartments a snap. Integral “Easy Pour” leveling feet are standard on all of the box bottoms. Several box depths are available and are UL listed.

The unit includes all of the necessary internal plates and brackets to make “pre” and “post” pour compartment changes quick and easy. Using this system, both high and low voltage gang configurations, along with compartment isolation, can be implemented “on the fly”. This makes just about any cabling/connector scenario possible.

## SPECIFICATIONS

Size:	Box:	13.5” x 12” x depth
	Cover:	14” x 12.5” x .125”
Flanging:	Height:	.25” or .5”
	Material:	Brass or Aluminum Flat and Solid Covers also available
Max Load		
Capacities:	FL-600P Hinged U-Access Cover with 1/4” Trim:	1,200 lbs.
	FL-600P Hinged U-Access Cover with 1/2” Trim:	1,500 lbs.
	FL-600P solid Hinged U-Access Cover:	2,600 lbs

## FIRE-RESISTANT FLOOR BOXES

FSR also offers a line of larger Fire-Resistant floor boxes. Our FL-500P-6-FRK and FL-605P-6-FRK floor solutions expand the versatility of our floor box line by providing enhanced, fire-resistant versions of our existing products. Our FRK kits are UL listed and comply with UL 263 Fire Resistance Ratings. See Fire Rated Brochure for details.

## Protect Your Connectors From Dust & Dirt

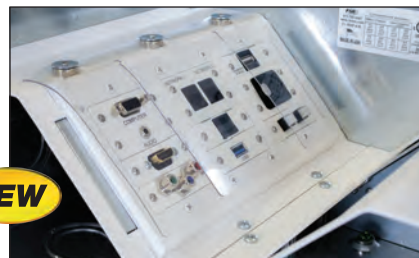

New Floor Box  
Gang Plate  
Dust Covers  
See Ordering  
Chart For  
Details

# BOX BOTTOM DETAIL DRAWINGS

## FL-600P-3-B

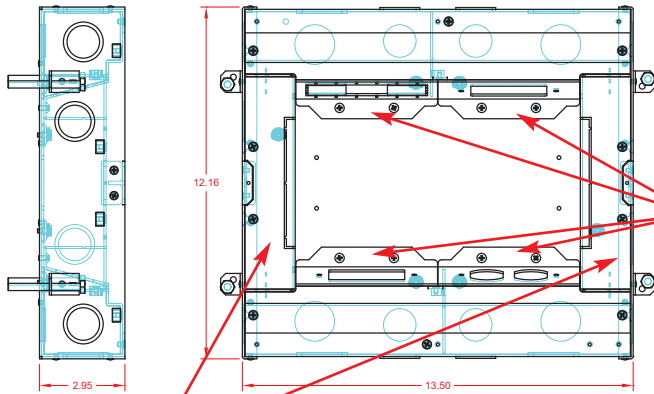

### FL-600P-3 Box Knockout Specifications

KO trade size	Qty/Box
3/4"	4
3/4" / 1.00"	10
1.00	4
1.00 / 1-1/4"	4

**MAIN** compartment areas include two duplex, two Decora and one 6-IPS brackets.  
Additional brackets are available as an option. (See ordering table)

"Pass-through" **END** compartment areas include brackets with integral blank plates.  
Additional brackets are available as an option. (See ordering table)

## FL-600P-4-B

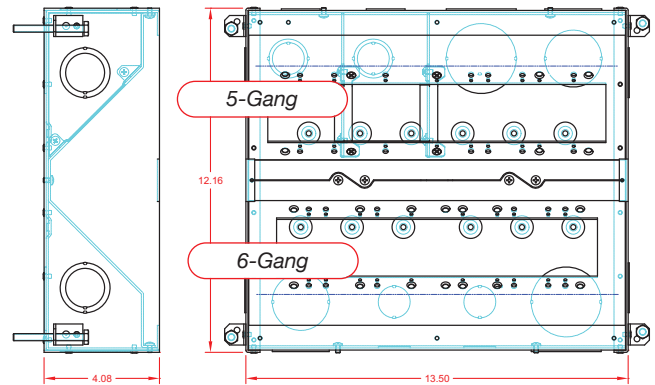

### FL-600P-4 Box Knockout Specifications

3/4"	4
3/4" / 1.00"	4
1.00" / 1-1/4"	4
1-1/2"	4
2.00"	4

## FL-600P-5-B & 6-B 5" & 6" Deep

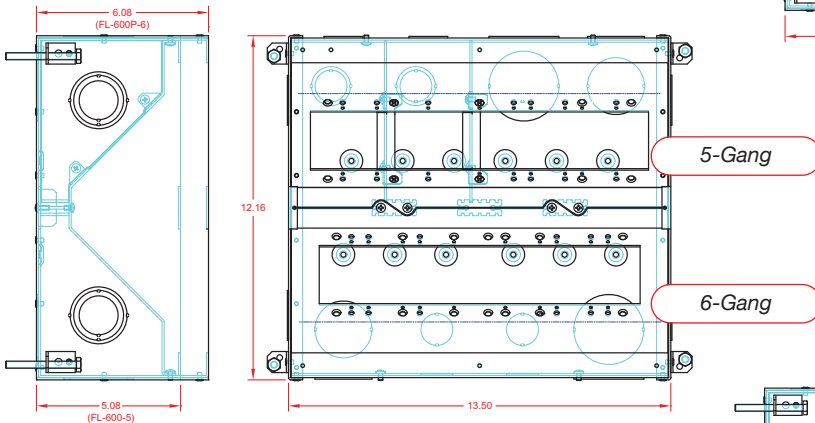

### FL-600P-5 & -6 Knockout Specifications

3/4"	4
3/4" / 1.00"	4
1.00" / 1-1/4" / 1-1/2"	4
1-1/2"	4
2.00"	4

## FL-600P-8-B

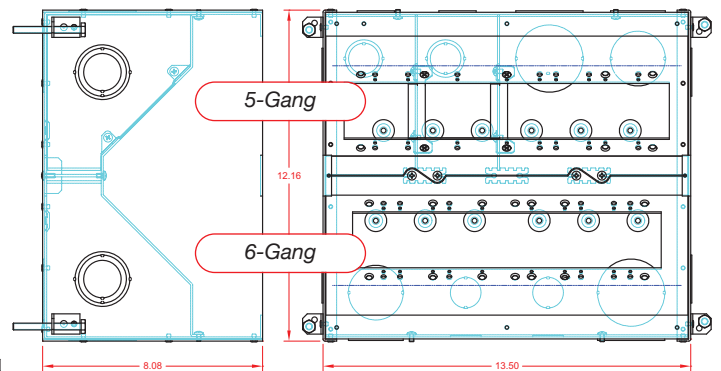

### FL-600P-8 & -10 Knockout Specifications

3/4"	4
3/4" / 1.00"	4
1.00" / 1-1/4" / 1-1/2"	4
1-1/2"	4
2.00"	4

## FL-600P-10-B

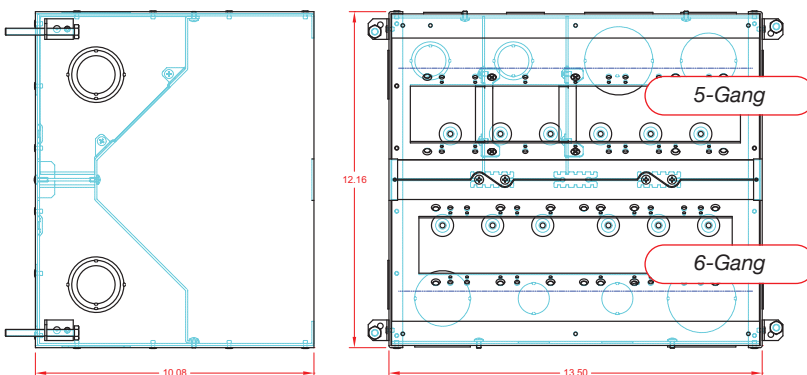

# **PLATE CONFIGURATIONS**

All boxes can be configured as shown, using the included parts.

## **5-gang side shown (4" through 10" boxes)**

**Plate Configuration 1-1-2**

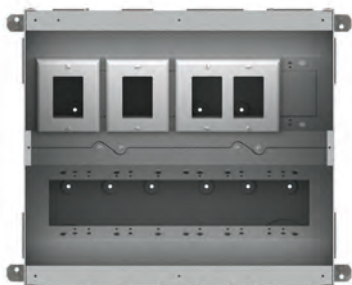

**Plate Configuration 1-1-3**



**Plate Configuration 1-3-1**

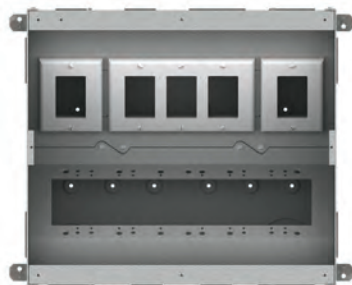

**Plate Configuration 1-4**

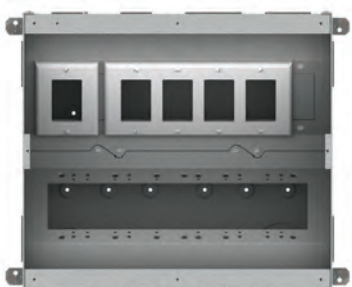

**Plate Configuration 2-2**

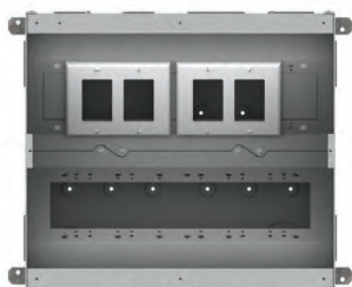

**Plate Configuration 2-3**

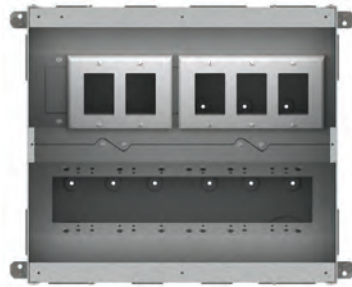

**Plate Configuration 4-1**



**Plate Configuration 5-0**

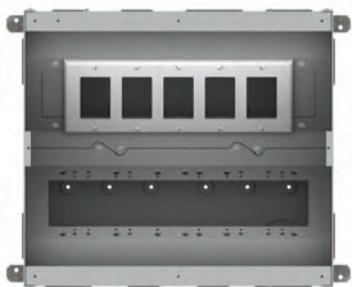

*\*Decora plate shown for reference only.*

---

## **6-gang side shown (4" through 10" boxes)**

**Plate Configuration 1-3 (a)**

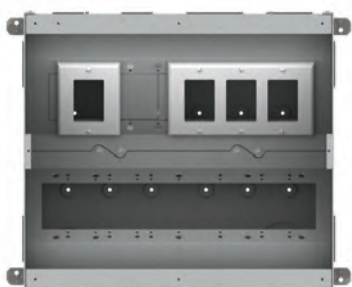

**Plate Configuration 1-3 (b)**

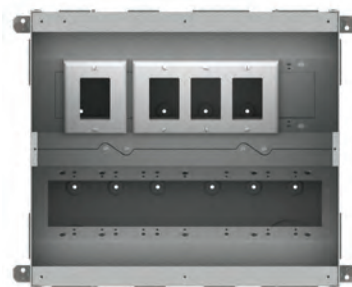

**Plate Configuration 1-4**

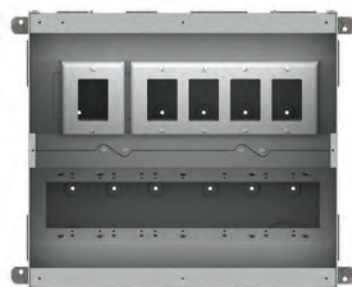

# PLATE CONFIGURATIONS

6-gang side shown (4" through 10" boxes) continued

Plate Configuration 2-2 (a)

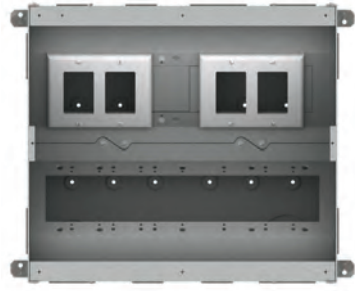

Plate Configuration 2-2 (b)

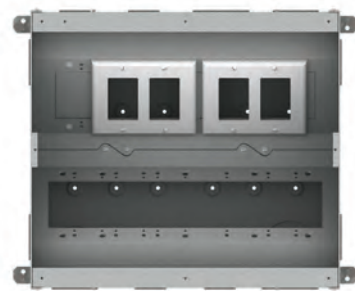

Plate Configuration 2-3

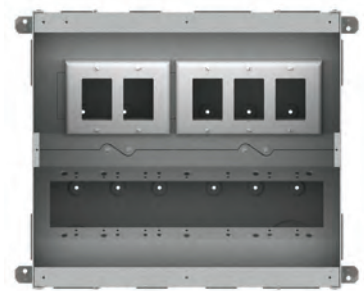

Plate Configuration 3-1

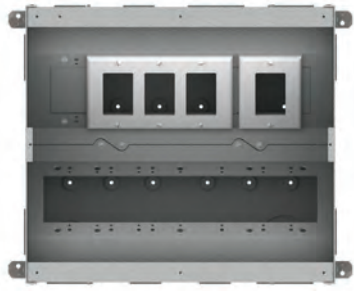

Plate Configuration 3-2

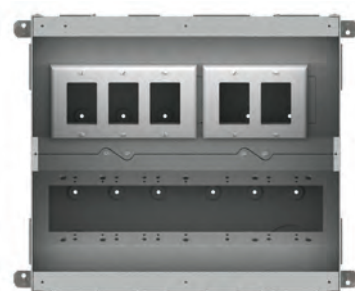
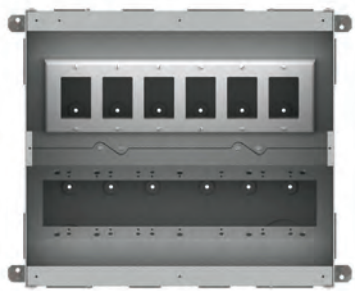

Plate Configuration 4-1



Plate Configuration 6-0



\*Decora plate shown for reference only.

# FL-600P "TRANSFORMABLE" BOX BOTTOM

**GANG PLATE DIVIDERS**  
Add and remove as needed to form a multitude of gang arrangement possibilities

**CENTER DIVIDERS**  
Remove to run cables across compartments (on 6" to 10" deep box bottoms)

**COMPARTMENT DIVIDERS**  
Remove or arrange as needed to isolate compartments  
**WARNING:** Must be used on a compartment where line voltage wiring is present

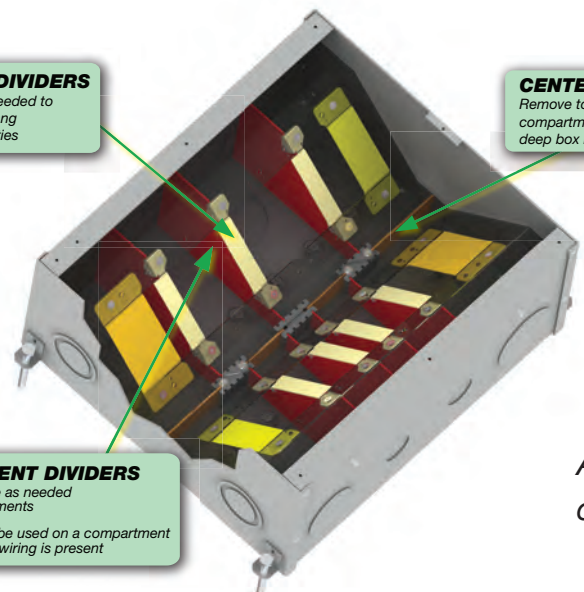

Available on 4" through 10" deep box bottom.

# HINGED COVER DETAIL DRAWINGS

**STYLE 1**

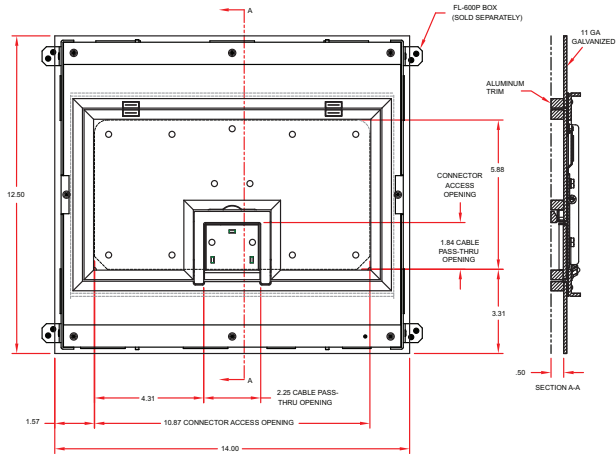

**STYLE 2**

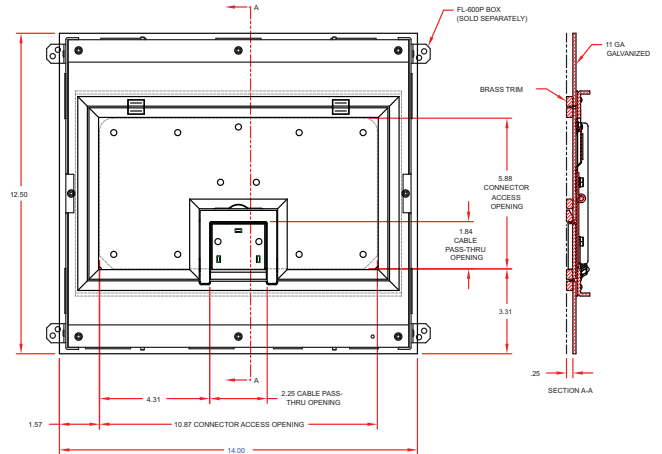

**STYLE 3**

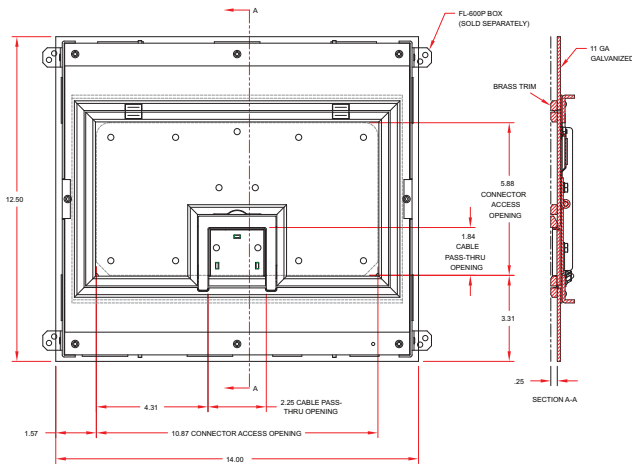

**STYLE 4**

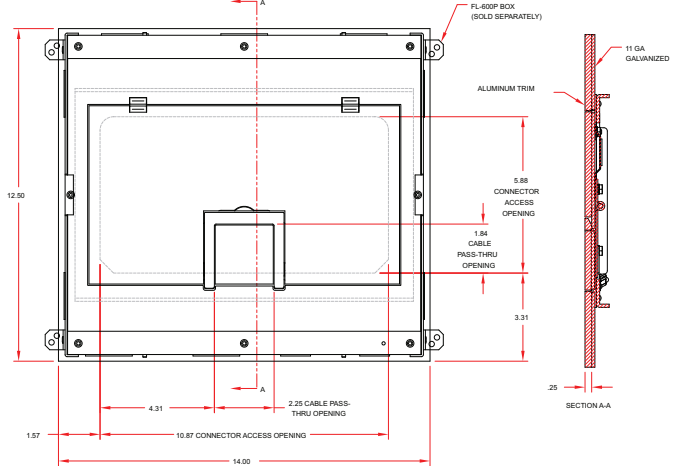

**STYLE 5**

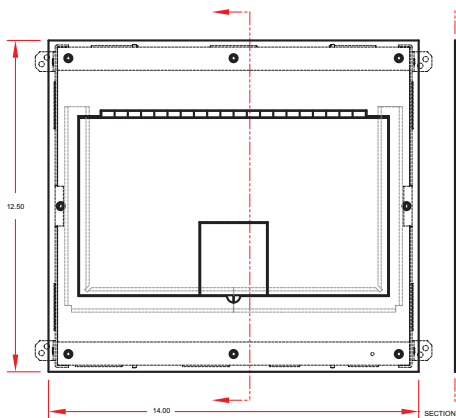

STYLE	DESCRIPTION
1	1/2" SQUARED FLANGE FOR CARPET OR TILE
2	1/4" SQUARED FLANGE FOR CARPET OR TILE
3	1/4" BEVELED FLANGE FOR CARPET
4	SOLID COVER, NO FLANGE**
5	SOLID COVER, NO FLANGE, PIANO HINGED**

Additional Flange heights and colors are available.  
Consult factory.

\*\*Note: Cover Shim Kit (FL-600-CSK) may be required to set the height of box "Pre-Pour" so the top of Finish Cover matches top of finished floor.

# COVER OPTIONS

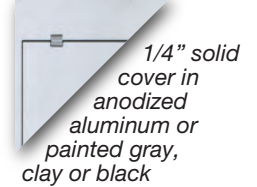
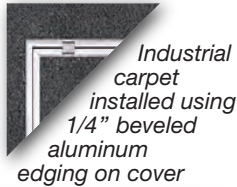
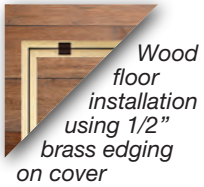

Available in brass, aluminum or painted edging to compliment floor covering.

Not all cover color options are pictured. See the ordering table below for additional options.



The new U-Access cover design features a handle to easily lift the cover. All corner fasteners have been removed.

## Floor Box Cover and box bottom ordering information FL-600P - Requires ordering Cover and box bottom separately

Item#	Part #	Description
<b>UL Listed Scrub Water Rated for Tile and Carpet Installations – U-Access Covers</b>		
15472	FL-600P-BK-C	Piano Hinge Flat Black Wrinkle Powder Coat Cover (No Flange)
18155	FL-600P-PTSLV	Piano Hinge Flat Painted Silver Cover (No Flange)
16945	FL-600P-SS-C	Piano Hinge Flat Stainless Steel Cover (No Flange)
18354	FL-600P-SLP-C	Hinged U-Access Floor Box Cover with 1/4" Aluminum Carpet Flange *Max static load 1,200 lbs
18454	FL-600P-BLP-C	Hinged U-Access Floor Box Cover with 1/4" Brass Carpet Flange *Max static load 1,200 lbs
18455	FL-600P-BSQ-C	Hinged U-Access Floor Box Cover with 1/4" Square Brass Flange *Max static load 1,200 lbs
18456	FL-600P-B-C	Hinged U-Access Floor Box Cover with 1/2" Brass Squared Flange *Max static load 1,500 lbs
18457	FL-600P-SSQ-C	Hinged U-Access Floor Box Cover with 1/4" Square Aluminum Flange *Max static load 1,200 lbs
18458	FL-600P-S-C	Hinged U-Access Floor Box Cover with 1/2" Aluminum Carpet Flange *Max static load 1,500 lbs
18459	FL-600P-PLP-BLK-C	Hinged U-Access Floor Box Cover with 1/4" Black Painted Carpet Flange *Max static load 1,200 lbs
18461	FL-600P-PLP-GRY-C	Hinged U-Access Floor Box Cover with 1/4" Black Painted Carpet Flange *Max static load 1,200 lbs
18462	FL-600P-SLD-ALU-C	Hinged U-Access Floor Box Solid Aluminum Cover with Cable Exit (No Trim) *Max static load 2,600 lbs
18463	FL-600P-SLD-BLK-C	Hinged U-Access Floor Box Solid Black Cover with Cable Exit (No Trim) *Max static load 2,600 lbs
18465	FL-600P-SLD-GRY-C	Hinged U-Access Floor Box Solid Gray Cover with Cable Exit (No Trim) *Max static load 2,600 lbs
<b>Box Bottom - UL Listed - Includes Steel Construction Cover</b>		
17283	FL-600P-3-B	FL-600P Box Bottom - 3" Deep 6 x 1-Gang Areas
15476	FL-600P-4-B	FL-600P Box Bottom - 4" Deep
18080	FL-600P-5-B	FL-600P Box bottom - 5" Deep
15475	FL-600P-6-B	FL-600P Box Bottom - 6" Deep
17118	FL-600P-8-B	FL-600P Box Bottom - 8" Deep
17182	FL-600P-10-B	FL-600P Box Bottom - 10" Deep
<b>Optional Brackets for FL-600P-3-B Box Bottom (END compartment areas)</b>		
17302	FL-600P3"-EP-DEC	Decora Optional Bracket
17303	FL-600P3"-EP-DUP	Duplex Optional Bracket
17304	FL-600P3"-EP-4IPS	4-IPS Optional Bracket
<b>Optional brackets for FL-600P-3-B Box Bottom (MAIN compartment areas)</b>		
17298	FL-P3"-Decora	Decora optional Bracket
17299	FL-P3"-Duplex	Duplex optional Bracket
17300	FL-P3"-6IPS	6-IPS optional Bracket
17301	FL-P3"-Blank	Blank optional Bracket
<b>Optional Manufacturers Specific Mounting Brackets</b>		
99495	MMS-FL-600/640P-4	Crestron DM-TX-200-C-2G Wallplate Mounting Bracket w/Blank Plate (4" deep box only)
<b>Pour Pan Accessories</b>		
16212	FL-GRD2	2" Grade Mounting Kit
16213	FL-GRD4	4" Grade Mounting Kit
<b>Optional Shim Kit** and Accessories</b>		
17805	FL-600P-CSK	Temporary and Final Cover Shim Kit
18668	FL-600P-DCIH	(2) Gang Plate Dust Covers For FL-400 and FL-600P

See a larger view at [bit.ly/1aKZzT6](http://bit.ly/1aKZzT6) or scan this QR Code

