

manual

## ez-LINE VM16 FullHD 16x16 Matrix Router (SD/HD/3G-SDI)

- 3G/HD/SD-SDI, IN/OUT 16 Port
- Automatic Equalization
- Reference Input Port
- Remote Control Panel through RS-422 Port
- Ethernet Support

### 16x16 Matrix Router *ez-Line*



SDI Output x16



SDI Input x16

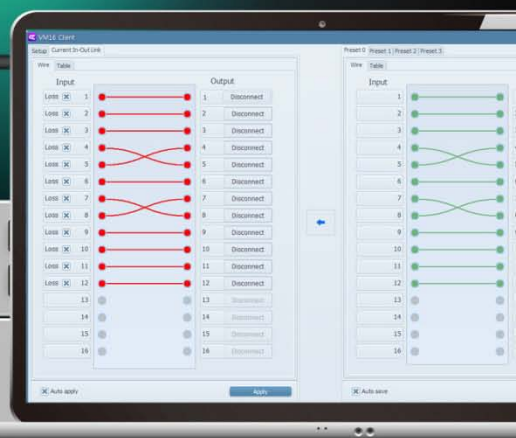
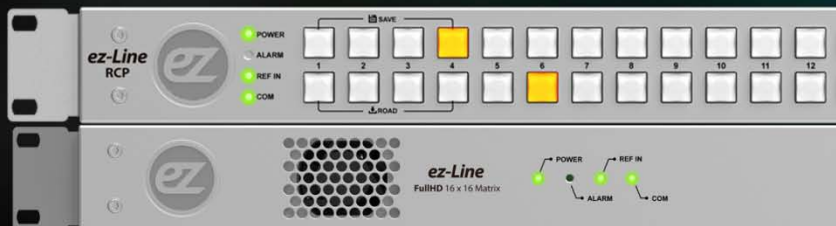



## ez-Line Manual

Revision Number: 1.2.3

Distribution Date: July, 2016

### Copy Rights

Copyright © 2006~2015 LUMANTEK Co., Ltd.

All Rights Reserved

This document contains information that is proprietary to LUMANTEK.CO., LTD. The information in this document is believed to be accurate and reliable; however, LUMANTEK assumes no responsibility or liability for any errors or inaccuracies that may appear in this document, nor for any infringements of patents or other rights to third parties resulting from its use.

This publication may contain technical issues, inaccurate information or typos. These will be revised in revised edition, if there is any. No part of this publication is subject to be reproduced, stored in retrieval system, or transmitted in any forms, or any means without the prior consent by Lumantek.

### Trademarks

HD ENCODULATOR™, SD ENCODULATOR™ LUMANTEK Logo, Mega Cruiser™, ORIX™, X-Cruiser™, DTA-Plus™, Media Blaster™, are Trademarks of Lumantek. Co., Ltd.

Any other trademarks than stated above in this document belongs to its pertinent corporation.

### Warranty Period

Lumantek's products comes with One(1) year limited warranty. Please contact below if you need more information.

LUMANTEK CUSTOMER SERVICES

[sales@lumantek.co.kr](mailto:sales@lumantek.co.kr) / TEL(Dir) : +82-2-6947-7429 / FAX: +82-2-6947-7440



## Installation Precautions

This page states the safety measures the users must take to avoid circumstances where the system may occur physical damages or injuries. Please THOROUGHLY go over this page before the system installation/operation.

## General Precautions

- Maintain dust FREE condition during and after System Installation/Operation.
- Please place the system cover in a safe location when opened.
- Securely stow tools and cables away from the passages.
- Avoid wearing loosened clothes or accessories during installation/Operation.
- Avoid any unnecessary actions that may damage/harm system or personnel.
- Do NOT open the system unless advised by Lumantek representative. Lumantek takes no responsibility on units with broken RMA seals.

## Power Precautions

- Please check cable overload before connecting the system to the power supply.
- Avoid wearing metal accessories (Rings, Earrings) connecting system to the power source.
- Avoid operating on wet floors. Make sure power extension cables, floors, and instruments are grounded and in a safe operating condition.



- Please discharge static electricity by touching grounding metals before starting hardware installation.
- The grounding parts must be disassembled last.
- Manufacture takes no responsibilities on Direct/Indirect losses or damages due to use of inappropriate parts or services by unauthorized service provider
- Supplying power during the system installation may cause damages to the system and personnel.

## AC Power Precautions

- This unit utilizes AC power, the cord comes with a grounding function.
- Please connect the system to the power socket with groundings.
- Use Green/Yellow 0.75mm<sup>2</sup> (18AWG) or higher grade grounding cables.
- Do NOT block power sockets with tools or boxes. Please keep it clear at all times.



## Contents

1. Introduction .....	5
2. VM16 System Information .....	6
2.1 VM16 Main Frame Interface .....	6
2.2 VM16 RCP Interface .....	7
2.3 Product Components .....	8
2.4 System Operation .....	9
3. Specifications .....	15
4. Communication Protocol .....	16
4.1 Transport Packet Structure.....	16
4.2 Transport Procedure.....	16
4.3 Parameter List .....	17
4.4 Command List .....	18
4.5 Response/ Notification List .....	19
5. Appendix .....	20



## 1. VM16 (FullHD 16x16 Matrix Router) Introduction

ez-line (VM16) is a SDI Matrix Router which support SD/HD/3G-SDI. it consists of 16 Input and 16 Output Ports. This equipment can be controlled with USBS 2.0, RS422, Ethernet port via the communication protocol. Additional S/W is provided to control VM16 via USB2.0, RS422 and Ethernet. Moreover, RS422 communication protocol to support RCP(Remote Control Panel).

### • Features

- ① Supports SD/HD/3G-SDI
- ② Video IN/OUT Port (IN 16, OUT 16 / BNC Connector)
- ③ Supports Reference Input Port (B.B , Tri-Level)
- ④ Supports USB2.0, RS422, Ethernet Port
- ⑤ Provides simple S/W UI for PC





## 2. VM16 Interface

### 2.1 VM16 Main Frame Interface < Front >

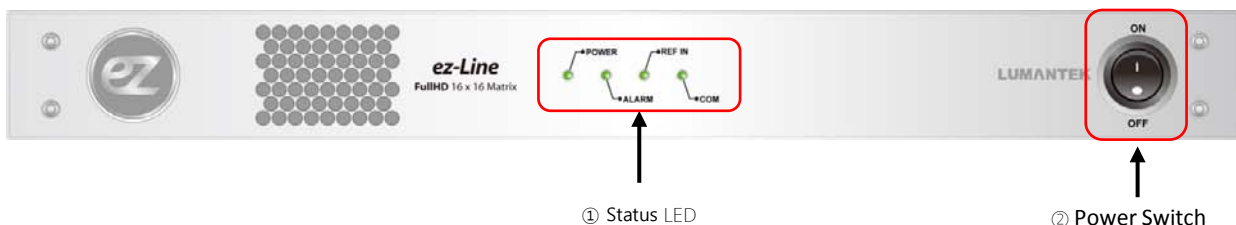

① LED Status

- POWER : Indication of power input, Green light indicates power on.
- ALARM : Red light will turned on if there is error on internal communication.
- REF IN : Green light will turn on when Reference input is detected.
- COM : Green light will flash when it is controlled by RS422 and Ethernet Port.

② Power Switch : AC Power ON/OFF Switch

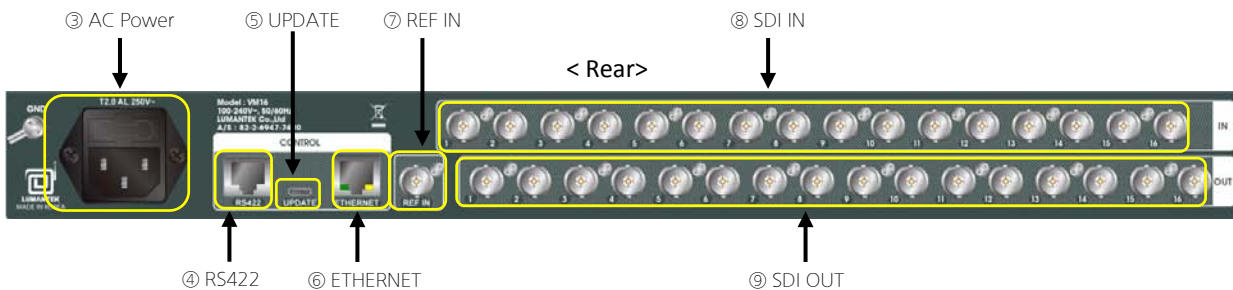

③ AC Power : AC Power input (100 -240V, 50/60Hz)

④ RS422 : RS422 communication Port for RCP and UI. communication protocol control (RJ45)

⑤ UPDATE : USB Port for UI. communication protocol control and firmware UPDATE (Micro USB)

⑥ ETHERNET : ETHERNET port. UI and communication protocol control (RJ45)

⑦ REF IN : Reference port. Support Black Burst, Tri-level (BNC Connector)

⑧ SDI IN : consist of 16 video input port (BNC Connector)

⑨ SDI OUT : consist of 16 video output port (BNC Connector)



## 2.2 VM16 RCP Interface

< Front >

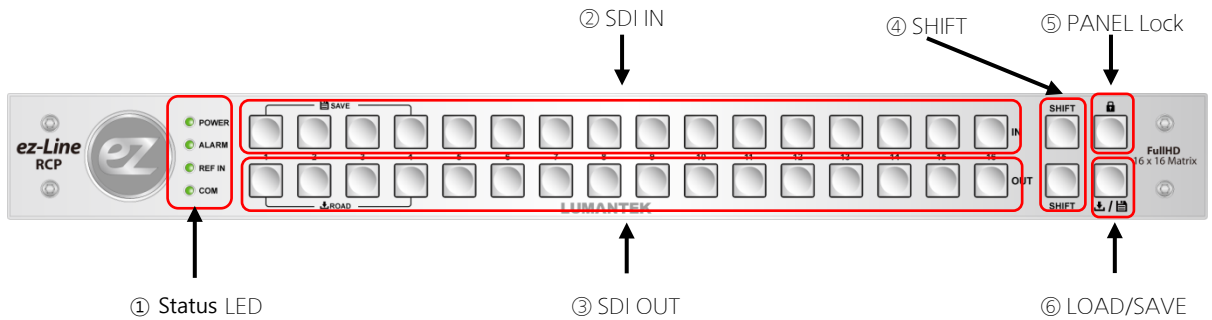

### ① Status LED

- POWER : Green light will turned on when the power is on.
- ALARM : Red light will turned on if there is error on internal communication.
- REF IN : Green light will turn on when Reference input is detected.
- COM : Green light will flash when it is control by RS422 and Ethernet Port.

### ② SDI IN : 16 SDI Input control buttons.

### ③ SDI OUT : 16 SDI Out control buttons.

### ④ SHIFT : Use SHIFT button, if SDI input ports are more than 16 ( Max in/output 32 port)

### ⑤ PANEL Lock : PANEL Lock button (LED ON : Panel Locked, LED OFF Status : Panel Unlocked )

### ⑥ LOAD/SAVE : When this button is pressed, 4 input and output buttons will turned on. 4 input button to saving the configuration and output button for load the configuration.

< Rear >

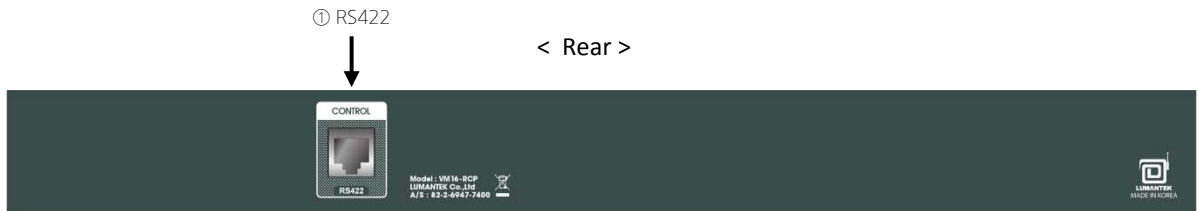

### ① RS422 : RS422 Communication Port



## 2.3 Product Components

### - Basic Components

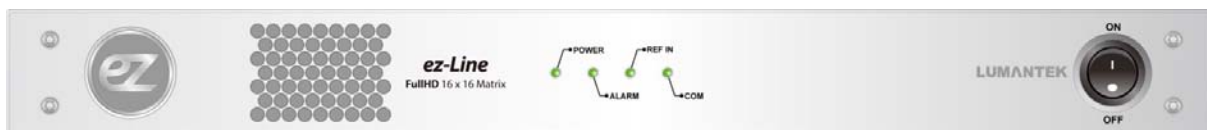

① VM16 Main Frame



② POWER CABLE

### - RCP



① Remote Control Panel





## 2.4 Product Operation

### 1) UI connection using RS422 or USB2.0 Communication

① Run EXE file -double click on “ez ezLineMatrix16x16.exe”

② Select RS422 Tab

③ PC COM recognition. Disabled if recognition failed.

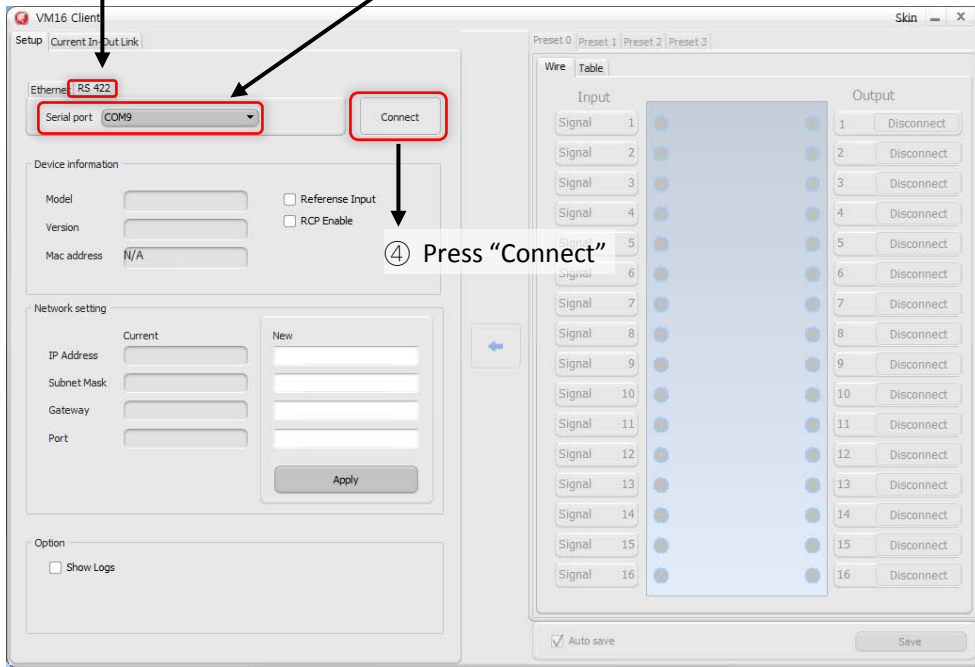

⑤ Device Information and Network Setting will be updated when communication is connected.

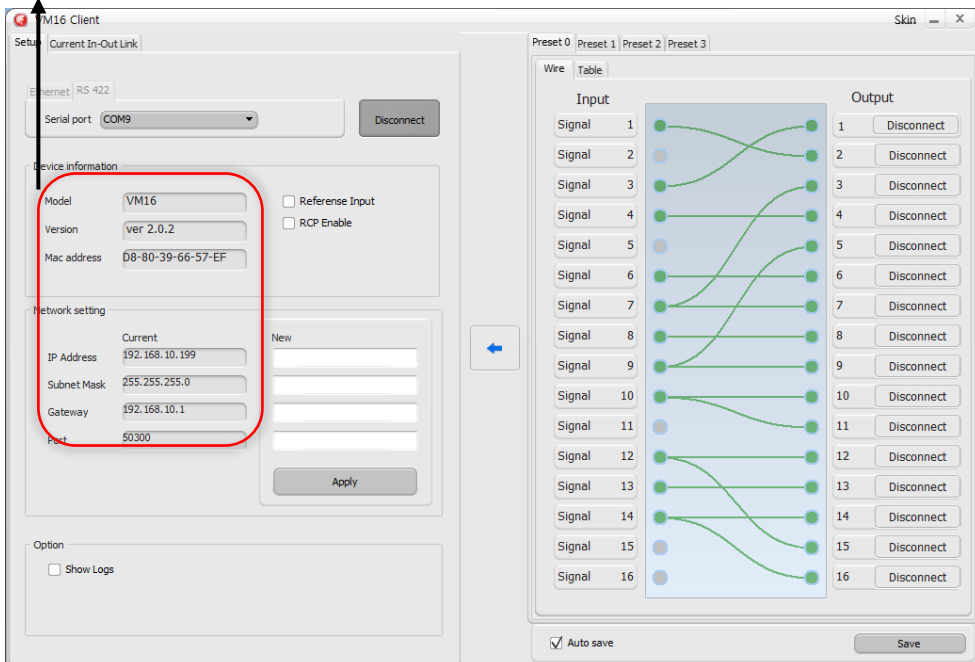



## 2) UI connection using Ethernet Communication

① Run EXE file -double click on “ ezLineMatrix16x16.exe ’

② Select Ethernet Tab.      ③ Setting for default IP address.

④ Press “Connect”

⑤ Device Information and Network Setting will be updated when communication is connected.



⑥ Communication failure lead to “No response from device” message on screen.

Connect through RS422 communication check IP address and change to desired IP address.

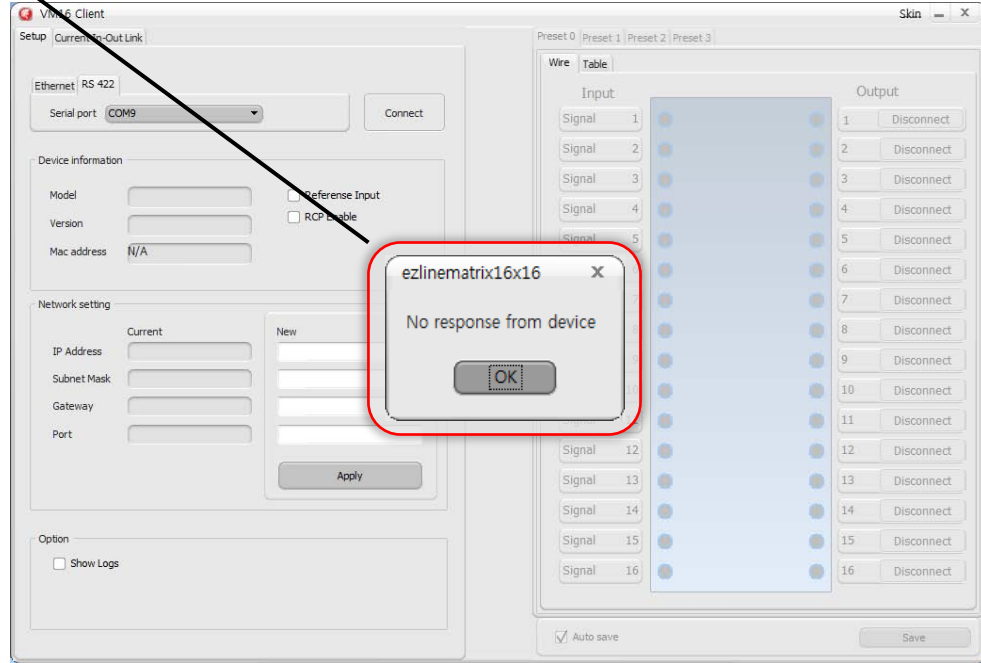

### 3) Changing IP address using RS422 Communication..

① Run EXE file -double click on “ ezLineMatrix16x16.exe

② Select RS422 Tab

③ PC COM recognition. Disabled if recognition failed.

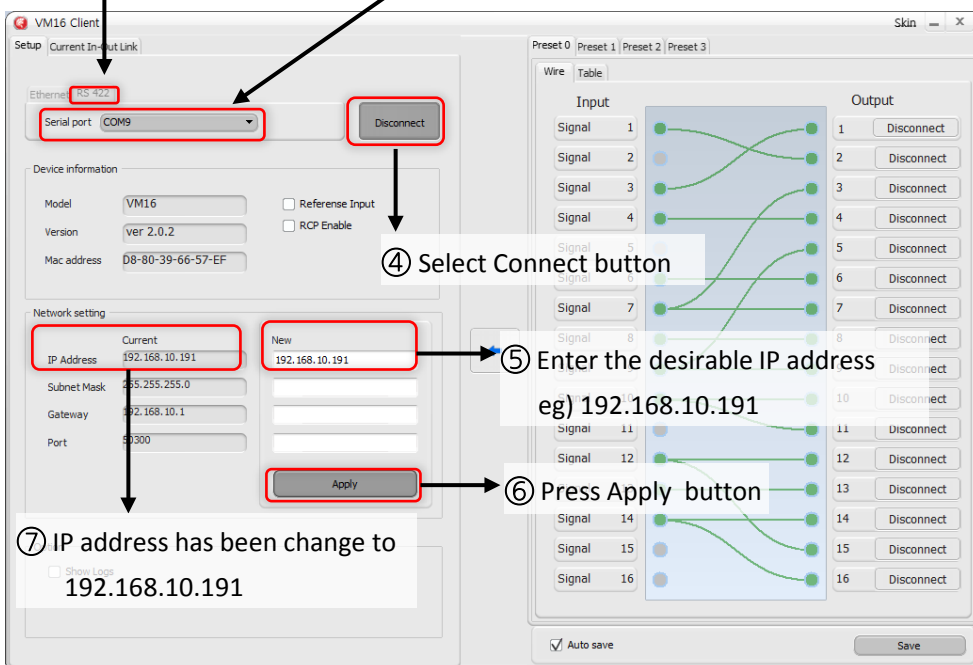



#### 4) Setting for Input/Output S/W UI

- ① Using RS422 or Ethernet communication, connect to device UI.
- ② Select Current In-out Link Tab.
- ③ Input/Output setting is set by dragging mouse from input to output or output to input.
- ④ Input window displays the signal information. X will display on the box If there is no signal input.
- ⑤ If user click 'Auto apply' box , any changes on input/output setting will be applied immediately.
- ⑥ if user left 'Auto apply' box unchecked , then user must press 'Apply' button manually after changing input/output setting to apply it.

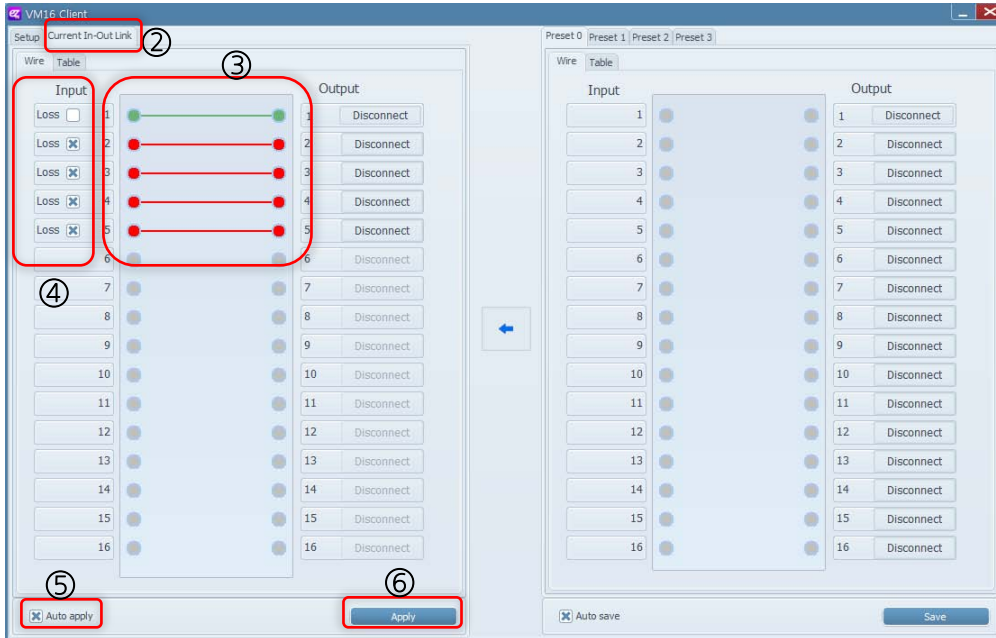

- ⑦ Can use this device as a SDI distributor, set a single input to multiple outputs.

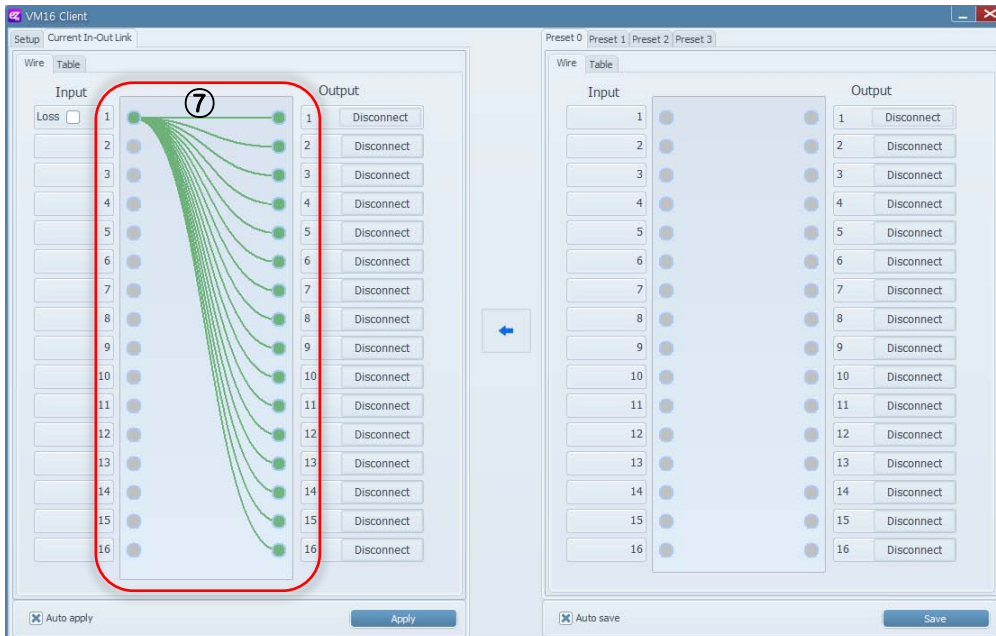



### 5) Load and Save feature for input/output settings

- ① Use RS422 or Ethernet communication to connect the equipment and S/W UI
- ② Support up to 4 Preset settings. (below showing Preset 0 setting)
- ③ Input/output setting is set by dragging mouse from input to output or output to input.
- ④ When you press 'Save' button ,the setting will be saved on Preset 0 , but current input and output is not applied. (if 'Auto save' box is clicked then the setting is saved automatically)
- ⑤ Current input/output settings.

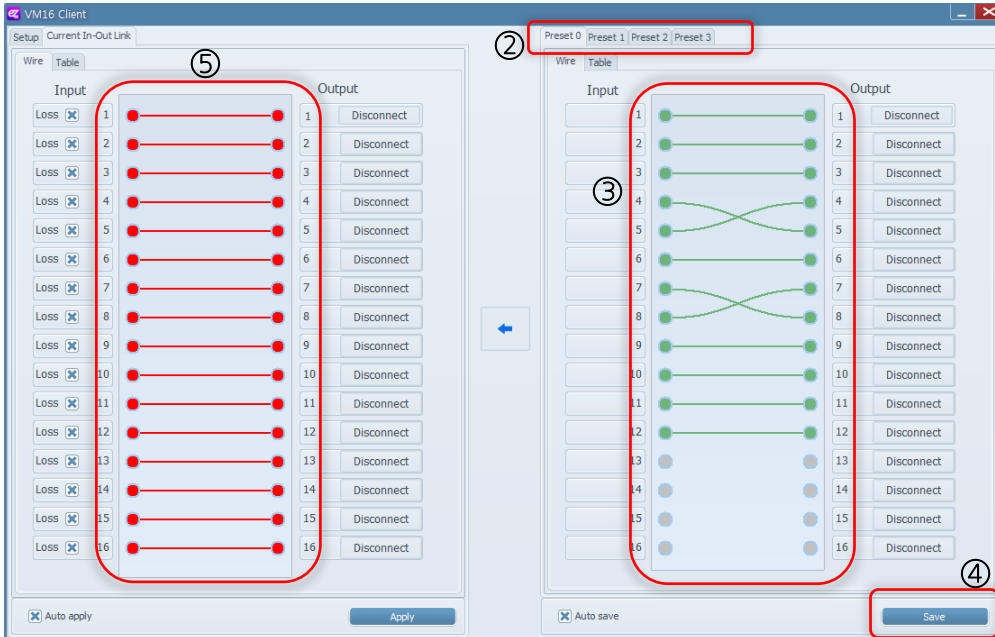

- ⑥ Click arrow button to apply Preset 0 Setting to current setting.

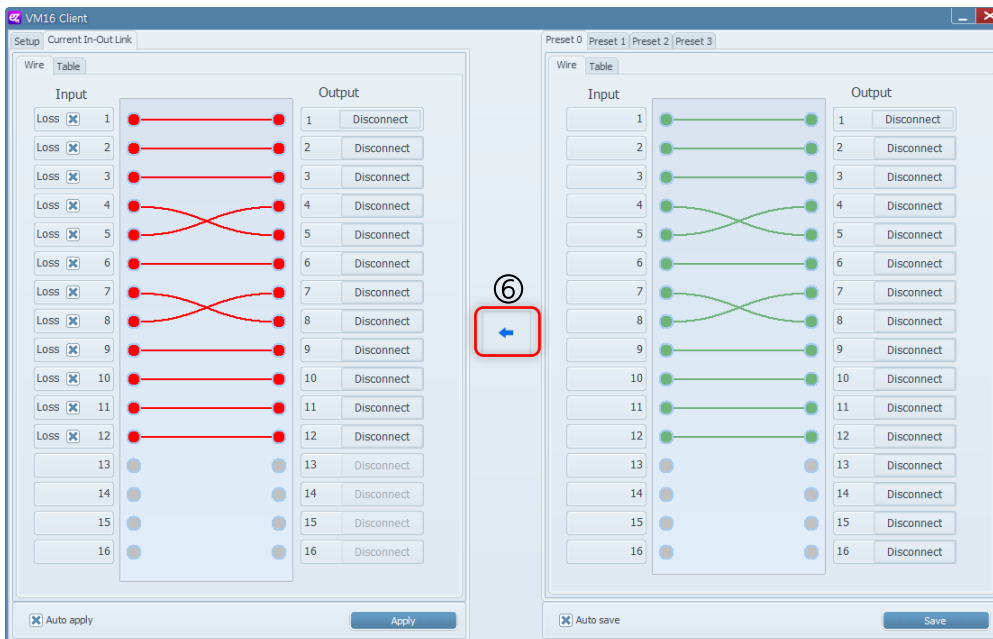



## 6) RCP Connection Using RS422 or Update Port

### ① VM16 Main Frame RS422 setting

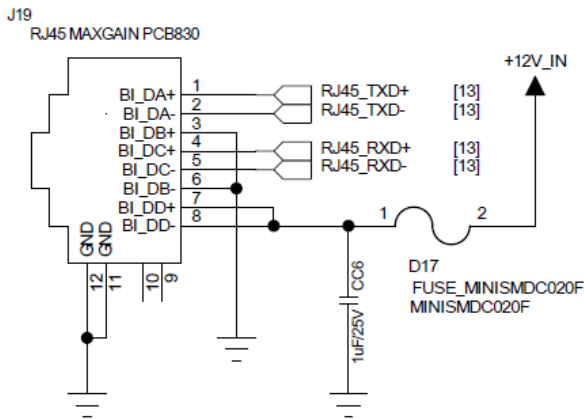

### ② VM16 RCP (Remote Control Panel RS422 setting

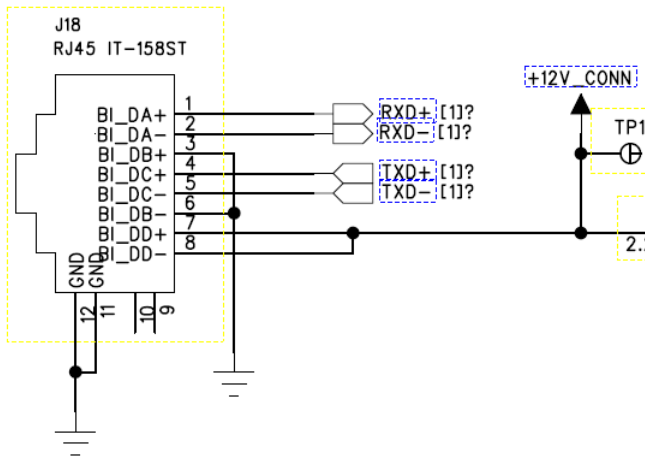

### ③ VM16 Main Frame and RCP are connected by Direct Cable.





### 3. Specification

#### Data Input

SDI Video Input: SD/HD/3G-SDI (BNC 75Ω) x16

Reference Input: B.B , TRI (BNC 75Ω) x1

#### Data Output

SDI Video Input: SD/HD/3G-SDI (BNC 75Ω) x16

#### Connections

Remote Control: RS-422 (RJ45)x1

Ethernet: Ethernet Support (RJ45)x1

Update: Debug (Micro-USB)x1

#### Electrical

Power Input: 100~240VAC @ 50/60Hz

Power Consumption: 18W(max.)

Operation Temperature: 0~40 °C

#### Physical

Dimension: 44(H) X 483(W) X 240(D)

Weight: 2.0 kg



## 4. Communication Protocol

### 4.1 Transmission Packet Structure

- ▶ It can communicate with common serial terminal software and Command based communication, also using checksum to allow error detection.

Index Header	Index	Space	Command/Response/Notification	Space	Parameters	Space	Checksum	Carriage Return
#(0x23) \$(0x24)	0~ 65535	' ' (0x20)	~ ` a~z (0x5F~0x7A)	' ' (0x20)	0~9 (0x30~0x39) ' '(0x20)	' ' (0x20)	A~P (0x41~ 0x50)	'/r' (0x0D)

- ▶ Index Header: Command and Response '#', Notification '\$'. If command line does not start with #, it will consider to not having Index.
- ▶ Index: Command Response Notification indexing number (10) decimal 1~5 digits (0~65535)
- ▶ Command/Response/Notification: ASCII code consist of 2 special characters and small letters, between 0x5F~0x7A, See Command and Response/Notification list
- ▶ Parameter: determined by number of Command/Response/Notification, each parameter is separated by space
- ▶ Checksum: displayed in hexadecimal with capital A~P. Add byte from Index header to Checksum in 2 byte size. expressed in 4 digits hexadecimal. Simplified hexadecimal so that doesn't use (0~9)(A~F). Use continues A~P, take 4 bits from each checksum byte and add A to convert it. (see Appendix 1 -example)
- ▶ Carriage Return: '/r' text sent as a packet terminal indication, see Terminal settings.

### 4.2 Transfer Procedure

- ▶ Transferring side: Command
- ▶ Reception Side: Reception Command/ execution and then transfer /execution results Response
- ▶ After sending Command if there is no response for 10ms, then Time-Out.
- ▶ Time-Out or error responses, 3 times further repeated transfer and then give up. Communication error .
- ▶ Notification is sent to indicate a state changes from device to the host.

**Serial Options**

Port:	COM	▼	Flow Control <input type="checkbox"/> DTR/DSR <input type="checkbox"/> RTS/CTS <input type="checkbox"/> XON/XOFF
Baud rate:	115200	▼	
Data bits:	8	▼	
Parity:	None	▼	
Stop bits:	1	▼	





### 4.3 Parameter List

Category	Parameter List
# Input Channel Category	0: SDI Input 1 1: SDI Input 2 2: SDI Input 3 3: SDI Input 4 4: SDI Input 5 5: SDI Input 6 6: SDI Input 7 7: SDI Input 8 8: SDI Input 9 9: SDI Input 10 10: SDI Input 11 11: SDI Input 12 12: SDI Input 13 13: SDI Input 14 14: SDI Input 15 15: SDI Input 16 31: No Connect
# Output Channel Category	0: SDI Output 1 1: SDI Output 2 2: SDI Output 3 3: SDI Output 4 4: SDI Output 5 5: SDI Output 6 6: SDI Output 7 7: SDI Output 8 8: SDI Output 9 9: SDI Output 10 10: SDI Output 11 11: SDI Output 12 12: SDI Output 13 13: SDI Output 14 14: SDI Output 15 15: SDI Output 16
# Preset Category	0: Preset 1 1: Preset 2 2: Preset 3 3: Preset 4
# Loss Category	0: Signal is not loss 1: Signal is loss



## 4.4 Command List

Command	NOP	Description
set_cfg_all	16	Set command for 16 output associated 16 inport Param1~Param16, refer to <b>Input Channel List</b>
get_cfg_all	0	Get command for 16 output associated 16 inport
set_cfg_one	2	Set command for specified 1 output associated 1 inport Param1: see <b>Output Channel List</b> Param2: see <b>Input Channel List</b>
get_cfg_one	1	Get command for specified 1 output associated 1 inport Param1: see <b>Output Channel List</b>
get_inloss_all	0	Get command for 16 inport associated Loss [off/on] information
get_inloss_one	1	Get command for specified 1 inport signal Loss [off/on] information Param1: See <b>Input Channel List</b>
set_ipaddr	4	command to set for IP address
get_ipaddr	0	command to get the IP address
set_subnetmask	4	command to set subnet mask
get_subnetmask	0	command to get the subnet mask
set_gateway	4	Command to set the default gateway
get_gateway	0	Command to get the default gateway
set_port	1	Command to set the port number
get_port	0	Command to get the port number
get_macaddr	0	Command to get the Mac address
set_default	0	Load to default value and save to EEPROM
get_refined	0	Command to get REF IN LED on/off status
set_save_preset0	16	Command to save 16 output associated with 16 inport information on to EEPROM(Preset) Param1: See <b>Input Channel List</b>
get_preset0	0	Command to get 16 output associated with 16 inport information (Preset)
set_save_preset1	16	Command to save 16 output associated with 16 inport information on EEPROM (Preset) Param1: See <b>Input Channel List</b>
get_preset1	0	Command to get 16 output associated with 16 inport (Preset)
set_save_preset2	16	Command to save 16 output associated with 16 inport on EEPROM (Preset) Param1: See <b>Input Channel List</b>
get_preset2	0	Command to get 16 output associated with 16 inport information (Preset)
set_save_preset3	16	Command to save 16 output associated with 16 inport information on EEPROM (Preset) Param1: See <b>Input Channel List</b>
get_preset3	0	Command to get 16 output associated with 16 inport information (Preset)
set_apply_preset	1	Command to read and apply from Preset 0/1/2/3 EEPROM Param1: See <b>Preset List</b>
get_rcpll	0	Command to get the information of RCP Lock LED Off/On
checksum_en	0	Enable checksum
checksum_dis	0	Disable checksum
get_model	0	Model Name output
get_ver	0	Version information output



## 4.5 Response/ Notification List

Response/ Notification	NOD	Description
ok	0	Communication success
error_too_short	0	Communication failure: checksum digit is short
error_bad_checksum	0	Communication failure: checksum parameter is not right, checksum digit is too long.
error_checksum	0	Communication failure: checksum value is not right
error_invalid_param	0	Communication failure: invalid parameter
error_invalid_command	0	Communication failure: invalid command
state_model	1	Model name output Data1: Model name (VM16, VS6, VM6, VM4,...)
state_ver	3	Version information Data1: Major Version Data2: Minor Version Data3: Revision
state_cfg_all	16	Information status of 16 outport associated 16 inport Data1 ~ Data16 : See <b>Input Channel List</b>
state_cfg_one	2	Information status of specified 1 outport Data1: See <b>Output Channel List</b> Data2: See <b>Input Channel List</b>
state_inloss_all	16	Information status of Signal Loss [off/on] for 16 inport Data1 ~ Data16: See <b>Loss List</b>
state_inloss_one	2	Information status of signal Loss [off/on] for specified inport Data1: <b>Input Channel loss List</b> Data2: See <b>Loss List</b>
state_ipaddr	4	IP address status Data1~ Data4 : IP address
state_subnetmask	4	Subnet mask status Data1~ Data4 : Subnet mask address
state_gateway	4	Gateway status Data1~ Data4 : Gateway address
state_port	1	Port number status Data1: Port number
state_macaddr	6	Mac address status Data1~ Data6 : Mac address
state_refinled	1	REF IN LED status Data1: 0/1 = led off/led on
state_preset0	16	Information status for 16 outport associated with 16 inport (preset) Data1 ~ Data16 : See <b>Input Channel List</b>
state_preset1	16	Information status for 16 outport associated with 16 inport (preset) Data1 ~ Data16 : See <b>Input Channel List</b>
state_preset2	16	Information status for 16 outport associated with 16 inport (preset) Data1 ~ Data16 : See <b>Input Channel List</b>
state_preset3	16	Information status for 16 outport associated with 16 inport (preset) Data1 ~ Data16 : See <b>Input Channel List</b>
state_rcpll	1	RCP Lock Led status [0/1=off/on], 0 represent RCP controlling Data1: 0/1 = led off/led on



## 5. Appendix

Appendix A

checksum\_dis AFBC

c	h	e	c	k	s	u	m	_	d	i	s		total	hex					checksum			
99	104	101	99	107	115	117	109	95	100	105	115	32	12908	0512	0	5	1	2	A	F	B	C

Decimal : 1298 = hexadecimal 0x0512

- 0 + A = A
- 5 + A = F
- 1 + A = B
- 2 + A = C