



Operating Instructions

RING MASTER

O-Ring Installer

Model 70162/70163/70162K/70164

Rev. 02.22

ATTN: MUST USE PROPER TIRE BEAD BREAKING TOOL TO LOOSEN WHEEL ASSEMBLY PRIOR TO USING. FAILURE TO DO SO WILL RESULT IN LOSS OF WARRANTY, DAMAGING OF TOOL, OR INJURY/DEATH. THE RING MASTER TOOL IS NOT A BEAD BREAKER.



WARNING: Cancer and Reproductive Harm- www.P65Warnings.ca.gov

ESCO: EQUIPMENT SUPPLY COMPANY
15270 Flight Path Drive • Brooksville FL • 34604
Phone: 1-800-352-9852 • 352-754-1117 • Fax: 352-754-4508
Website: www.esco.net • Email: Sales@esco.net



WARNING:

This product as well as all tire tools should never be used by persons unless they have been properly trained according to O.S.H.A Regulation #29CFR1910.177 entitled "Servicing Single-Piece and Multi-Piece Rim Wheels."

CAUTION:

BEFORE USING THIS TOOL READ INSTRUCTIONS THOROUGHLY. THE USE OF THIS TOOL IN ANY OTHER APPLICATION IS BOTH A VOID OF WARRANTY AND CAN LEAD TO INJURY OR EVEN DEATH.

RING MASTER (MODEL #70162) OPERATING INSTRUCTIONS:

After placing bead flange as far inside the bead of tire as possible, do as follows to accomplish full installation of tire onto wheel assembly.

1. Place bottom cross bar, the bar with the two black ends as seen in **Figure 1**, inside of wheel at twelve and six o'clock position. Make sure the gripping plates are tight against the inner bevel of the wheel, adjust by loosening set bolts and sliding out until tight then tighten set bolts, adjust bottom gripping plate and then top, making sure as center as possible.

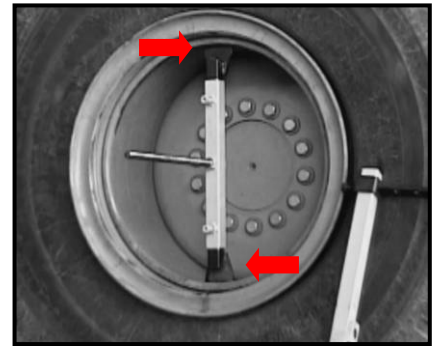

FIGURE 1

2. Hang the "O" Ring on the top set bolt of the bottom cross bar so as out of the way until installation of "O" Ring (**See Figure 2**).



FIGURE 2

3. Slide top cross bar assembly over the threaded center rod at the nine and three o'clock positions, so that the push bars line up against the rim flange. Adjust for the tire diameter of the wheel by loosening and tightening set bolts as needed (**See Figure 3**).

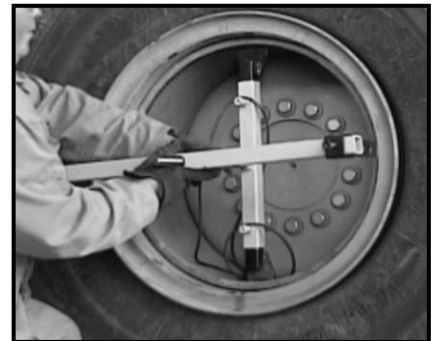

FIGURE 3

4. Depending on amount of travel left on the threaded center rod choose a round spacer or spacers and slide onto the threaded center rod as seen in **Figure 4**.

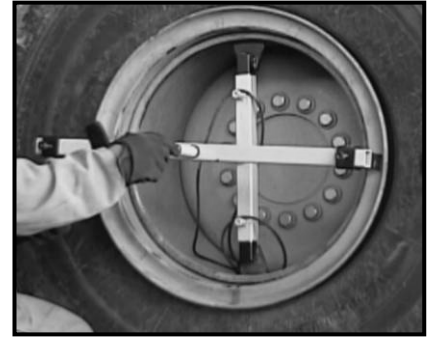

FIGURE 4

5. Turn the handle clockwise (**See Figure 5a**) onto the threaded center rod, simply turn while standing to one side until the push feet press against the rim flange, pushing the rim flange and bead of tire pass the "O" Ring groove allowing easy installation of the "O" Ring (**See Figure 5b**).

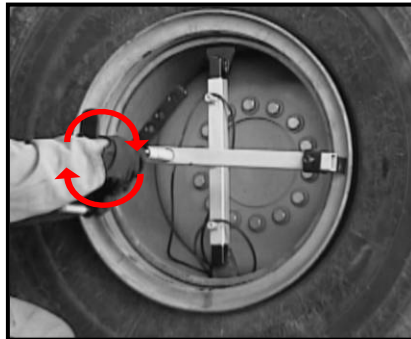

FIGURE 5a

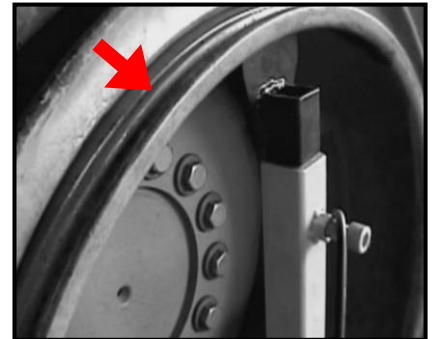

FIGURE 5b

Note: If the hand crack becomes hard to turn this usually means that the bead flange is slightly uneven with the wheel, simply tap the bead flange with a hammer and continue turning the hand crack.

6. After you have installed the "O" Ring (**Figure 6a**) you can also install the locking-ring (**Figure 6b**).

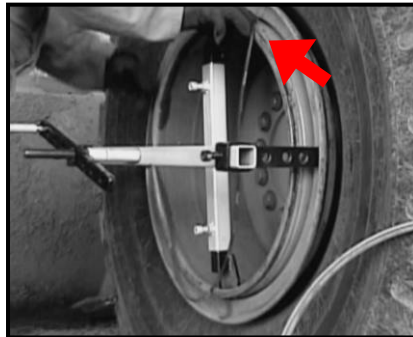

FIGURE 6a

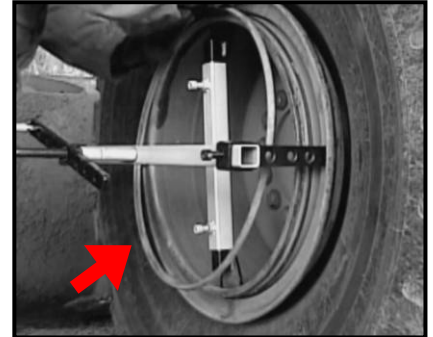

FIGURE 6b

7. After the locking-ring is locked into place turn the hand crack counter clockwise until off of the threaded center rod (**Figure 7**).

Note: Hold pressure onto the top cross bar unit with one hand at the beginning until you have the hand crack threaded securely against spacer or spacers, and at the end while removing hand crack from the threaded center rod. Simply remove device from wheel and inflate the tire.

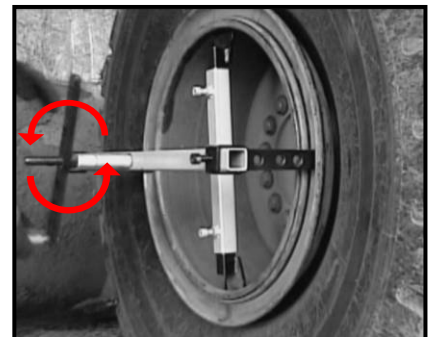

FIGURE 7

MODEL #70163
RINGMASTER KIT FOR:
EXTENDED PLANETARIES



ESCO: EQUIPMENT SUPPLY COMPANY
15270 Flight Path Drive • Brooksville FL • 34604
Phone: 1-800-352-9852 • 352-754-1117 • Fax: 352-754-4508
Website: www.esco.net • Email: Sales@esco.net



INSTRUCTIONS FOR EXTENTION KIT:

Remove bolts from wheel assembly at 12 and 6 o'clock position. Install bottom feet of RINGMASTER into bolt holes and tighten bolts. Center screw rod in center of wheel and tighten set screws.

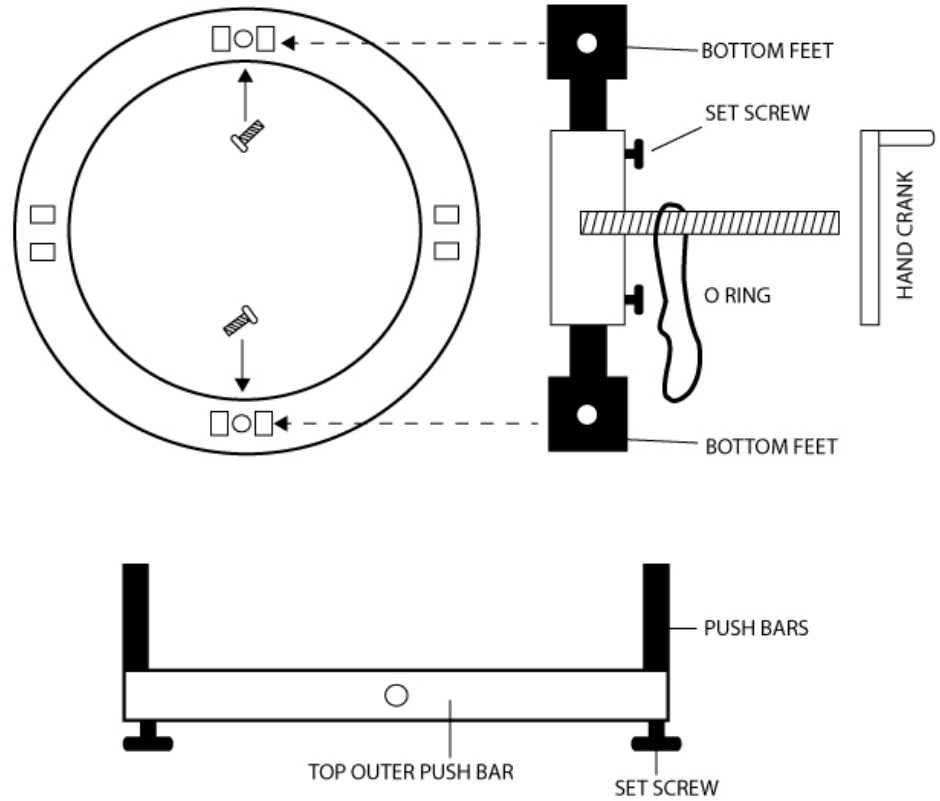

Place O-ring over screw rod. Slide outer push bar over or onto screw rod. Line up push bars with retainer ring and tighten set screws. Screw hand crank onto screw rod and turn.

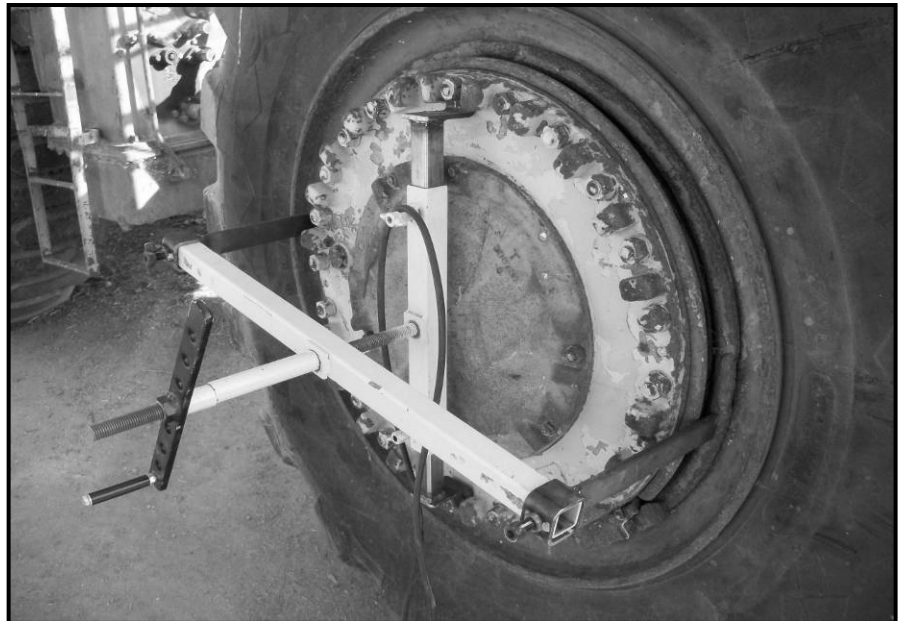

PARTS & ACCESSORIES:

Model #70162/70164

RINGMASTER

Includes:

- [2] **Standard Style Bottom Feet** (70162-1)
- [2] **Standard Style Push Bars** (70162-2)
- [1] **Handlebar** (70162-3)
- [4] **Spacers** (70162-4)
- [1] **Main Push Bar** (70162-5)
- [1] **Pull Bar w/ Threaded Rod** (70162-6)
- [4] **Thumb Screws** (70162-7)

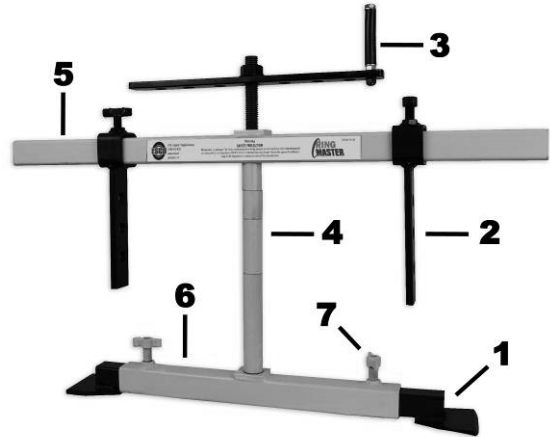

Model #70163

Extended Planetary Kit

Includes:

- [2] **Planetary Style Bottom Feet** (70163-1)
- [2] **Planetary Style Push Bars** (70163-2)



Model #70162K

RINGMASTER W/ Model #70163 Adaptors

Includes:

- [2] **Standard Style Bottom Feet** (70162-1)
- [2] **Standard Style Push Bars** (70162-2)
- [1] **Handlebar** (70162-3)
- [4] **Spacers** (70162-4)
- [1] **Main Push Bar** (70162-5)
- [1] **Pull Bar w/ Threaded Rod** (70162-6)
- [4] **Thumb Screws** (70162-7)
- [2] **Planetary Style Bottom Feet** (70163-1)
- [2] **Planetary Style Push Bars** (70163-2)

