



DTW BLINDER 700 IP™

user manual

©2021 ELATION PROFESSIONAL all rights reserved. Information, specifications, diagrams, images, and instructions herein are subject to change without notice. ELATION PROFESSIONAL logo and identifying product names and numbers herein are trademarks of ELATION PROFESSIONAL. Copyright protection claimed includes all forms and matters of copyrightable materials and information now allowed by statutory or judicial law or hereinafter granted. Product names used in this document may be trademarks or registered trademarks of their respective companies and are hereby acknowledged. All non-ELATION brands and product names are trademarks or registered trademarks of their respective companies.

ELATION PROFESSIONAL and all affiliated companies hereby disclaim any and all liabilities for property, equipment, building, and electrical damages, injuries to any persons, and direct or indirect economic loss associated with the use or reliance of any information contained within this document, and/or as a result of the improper, unsafe, insufficient and negligent assembly, installation, rigging, and operation of this product.

Elation Professional USA | 6122 S. Eastern Ave. | Los Angeles, CA. 90040

323-582-3322 | 323-832-9142 fax | www.elationlighting.com | info@elationlighting.com

Elation Professional B.V. | Junostraat 2 | 6468 EW Kerkrade, The Netherlands

+31 45 546 85 66 | +31 45 546 85 96 fax | www.elationlighting.eu | info@elationlighting.eu

DOCUMENT VERSION



Please check www.elationlighting.com for the latest revision/update of this manual.

Date	Document Version	Software Version	DMX Channel Modes	Notes
02/02/21	2	≥V1.2.0	01CH, Standard, Extended, 2CH, 4Cell, 4WA, Basic	New DMX Control Design and revised DTW curves.
06/02/21	3	N/C	No Change	Updated Installation

CONTENTS

General Information	4
Limited Warranty	7
Safety Instructions and Guidelines	8
Overview	10
Installation	11
System Menu	16
DMX Channel Functions And Values	20
Dim to Warm Features	23
Cleaning and Maintenance	26
Technical Specifications	27
Dimensional Drawings	28
Optional Accessories	29

GENERAL INFORMATION

INTRODUCTION

Congratulations, you have just purchased one of the most innovative and reliable IP65 rated lighting fixtures on the market today! This fixture has been designed to perform reliably for years when the guidelines in this booklet are followed. Please read and understand the instructions in this manual carefully and thoroughly before attempting to operate this unit. These instructions contain important information regarding safety during use and maintenance.



IP65 RATED

An IP rated lighting fixture is one, which is commonly installed in outdoor environments and has been designed with an enclosure that effectively protects the ingress (entry) of external foreign objects such as dust and water. The **International Protection (IP)** rating system is commonly expressed as "**IP**" (Ingress Protection) followed by two numbers (i.e. IP65) where the numbers define the degree of protection. The first digit (Foreign Bodies Protection) indicates the extent of protection against particles entering the fixture and the second digit (Water Protection) indicates the extent of protection against water entering the fixture. An IP65 rated lighting fixture is one, which has been designed and tested to protect against the ingress of dust (6) and low-pressure water jets from any direction (5).



MARINE/COASTAL ENVIRONMENT INSTALLATIONS!

Please note although this fixture is IP rated, the fixture is **NOT** suitable for marine and/or coastal environment installations. Installing this fixture in a marine and/or coastal environment may cause corrosion and/or excessive wear to the interior and/or exterior components of the fixture. Damages and/or performance issues resulting from installation in a marine and/or coastal environment will void the manufactures warranty and will **NOT** be subject to any warranty claims and/or repairs.



ENSURE ALL CONNECTIONS AND END CAPS ARE PROPERLY SEALED WITH A NON-CONDUCTIVE DIELECTRIC GREASE (AVAILABLE AT MOST ELECTRICAL SUPPLIERS) TO PREVENT WATER INGRESS/CONDENSATION AND/OR CORROSION.



OPTIONAL CORROSION-RESISTANT COATING

Optional Corrosion-Resistant Coatings may be available for this fixture. Please consult your **Elation Professional** sales representative for details.

UNPACKING

Every fixture has been thoroughly tested and has been shipped in perfect operating condition. Carefully check the shipping carton for damage that may have occurred during shipping. If the carton appears to be damaged, carefully inspect your unit for damage and be sure all accessories necessary to operate the unit have arrived intact. In the event damage has been found or parts are missing, please contact our customer support team for further instructions. Please do not return this unit to your dealer without first contacting customer support at the number listed below. Please do not discard the shipping carton in the trash. Please recycle whenever possible.

BOX CONTENTS

- (1) Power Cable
- (4) Removable 25° Narrow Beam Fresnel Lens (Installed)

CUSTOMER SUPPORT

Elation Professional® provides a customer support line, to provide set up help and to answer any question should you encounter problems during your set up or initial operation. You may also visit us on the web at www.elationlighting.com for any comments or suggestions. For service related issue please contact Elation Professional®.

ELATION SERVICE USA - Monday - Friday 8:00am to 5:00pm PST

Voice: 323-582-3322

Fax: 323-832-9142

E-mail: support@elationlighting.com

ELATION SERVICE EUROPE - Monday - Friday 08:30 to 17:00 CET

Voice: +31 45 546 85 30

Fax: +31 45 546 85 96

E-mail: support@elationlighting.eu

WARRANTY REGISTRATION

Please complete and mail in the enclosed warranty card or register online: <http://www.elationlighting.com/Login.aspx> to validate your purchase. All returned service items whether under warranty or not, must be freight pre-paid and accompany a return authorization (R.A.) number. The R.A. number must be clearly written on the outside of the return package. A brief description of the problem as well as the R.A. number must also be written down on a piece of paper and included in the shipping container. If the unit is under warranty, you must provide a copy of your proof of purchase invoice. Items returned without a R.A. number clearly marked on the outside of the package will be refused and returned at customer's expense. You may obtain a R.A. number by contacting customer support.



IMPORTANT NOTICE!

There are no user serviceable parts inside this unit. Do not attempt any repairs yourself; doing so will void your manufactures warranty. Damages resulting from modifications to this fixture and/or the disregard of safety and general user instructions found in this user manual void the manufactures warranty and are not subject to any warranty claims and/or repairs.

LIMITED WARRANTY

- A. Elation Professional® hereby warrants, to the original purchaser, Elation Professional® products to be free of manufacturing defects in material and workmanship for a period of two years (730 days), and Elation Professional® product rechargeable batteries to be free of manufacturing defects in material and workmanship for a period of six months (180 days), from the original date of purchase. This warranty excludes discharge lamps and all product accessories. This warranty shall be valid only if the product is purchased within the United States of America, including possessions and territories. It is the owner's responsibility to establish the date and place of purchase by acceptable evidence, at the time service is sought.
- B. For warranty service, send the product only to the Elation Professional® factory. All shipping charges must be pre-paid. If the requested repairs or service (including parts replacement) are within the terms of this warranty, Elation Professional® will pay return shipping charges only to a designated point within the United States. If any product is sent, it must be shipped in its original package and packaging material. No accessories should be shipped with the product. If any accessories are shipped with the product, Elation Professional® shall have no liability what so ever for loss and/or or damage to any such accessories, nor for the safe return thereof.
- C. This warranty is void if the product serial number and/or labels are altered or removed; if the product is modified in any manner which Elation Professional® concludes, after inspection, affects the reliability of the product; if the product has been repaired or serviced by anyone other than the Elation Professional® factory unless prior written authorization was issued to purchaser by Elation Professional®; if the product is damaged because not properly maintained as set forth in the product instructions, guidelines and/or user manual.
- D. This is not a service contract, and this warranty does not include any maintenance, cleaning or periodic check-up. During the periods as specified above, Elation Professional® will replace defective parts at its expense, and will absorb all expenses for warranty service and repair labor by reason of defects in material or workmanship. The sole responsibility of Elation Professional® under this warranty shall be limited to the repair of the product, or replacement thereof, including parts, at the sole discretion of Elation Professional®. All products covered by this warranty were manufactured after January 1, 1990, and bare identifying marks to that effect.
- E. Elation Professional® reserves the right to make changes in design and/or performance improvements upon its products without any obligation to include these changes in any products theretofore manufactured.
- F. No warranty, whether expressed or implied, is given or made with respect to any accessory supplied with the products described above. Except to the extent prohibited by applicable law, all implied warranties made by Elation Professional® in connection with this product, including warranties of merchantability or fitness, are limited in duration to the warranty periods set forth above. And no warranties, whether expressed or implied, including warranties of merchantability or fitness, shall apply to this product after said periods have expired. The consumer's and/or dealer's sole remedy shall be such repair or replacement as is expressly provided above; and under no circumstances shall Elation Professional® be liable for any loss and/or damage, direct and/or consequential, arising out of the use of, and/or the inability to use, this product.
- G. This warranty is the only written warranty applicable to Elation Professional® products and supersedes all prior warranties and written descriptions of warranty terms and conditions heretofore published.

SAFETY INSTRUCTIONS AND GUIDELINES

This fixture is an extremely sophisticated piece of electronic equipment. To guarantee a smooth operation, it is important to follow all instructions and guidelines in this manual. The manufacturer of this device is not responsible for injury and/or damages resulting from the misuse of this fixture due to the disregard of the information printed in this manual. Only qualified and/or certified personnel should perform installation of this fixture and only the original rigging parts (omega brackets) included with this fixture should be used for installation. Any modifications to the fixture and/or the mounting hardware included will void the original manufacturer's warranty and increase the risk of damage and/or personal injury.



PROTECTION CLASS 1 - FIXTURE MUST BE PROPERLY GROUNDED



DO NOT PLUG FIXTURE INTO A DIMMER PACK!

NEVER OPEN THIS FIXTURE WHILE IN USE!

UNPLUG POWER BEFORE SERVICING FIXTURE!

NEVER TOUCH FIXTURE DURING OPERATION, AS IT MAY BE HOT!

KEEP FLAMMABLE MATERIALS AWAY FROM FIXTURE!



NEVER LOOK DIRECTLY INTO THE LIGHT SOURCE!

RETINA INJURY RISK - MAY INDUCE BLINDNESS!

SENSITIVE PERSONS MAY SUFFER AN EPILEPTIC SHOCK!



ENSURE ALL CONNECTIONS AND END CAPS ARE PROPERLY SEALED WITH A DIELECTRIC GREASE (AVAILABLE AT MOST ELECTRICAL SUPPLIERS) TO PREVENT WATER CORROSION AND/OR ELECTRICAL SHORT CIRCUIT.

SAFETY INSTRUCTIONS AND GUIDELINES

- **DO NOT TOUCH** the fixture housing during operation. Turn OFF the power and allow approximately 15 minutes for the fixture to cool down before serving.
- **DO NOT** shake fixture, avoid brute force when installing and/or operating fixture.
- **DO NOT** operate fixture if the power cord has become frayed, crimped and/or damaged. If the power cord is damaged, replace it immediately with a new one of similar power rating.
- **DO NOT** block any air ventilation slots. All fan and air inlets must remain clean and never blocked. Allow approx. 6" (15cm) between fixture and other devices or a wall for proper cooling.
- When installing fixture in a suspended environment, always use mounting hardware that is no less than M10 x 25 mm, and always install fixture with an appropriately rated safety cable.
- Always disconnect fixture from main power source before performing any type of service and/or cleaning procedure. Only handle the power cord by the plug end, never pull out the plug by tugging the wire portion of the cord.
- During the initial operation of this fixture, a light smoke or smell may emit from the interior of the fixture. This is a normal process and is caused by excess paint in the interior of the casing burning off from the heat associated with the lamp and will decrease gradually over time.
- Consistent operational breaks will ensure the fixture will function properly for many years to come.
- Use the original packaging and materials to transport the fixture in for service.

OVERVIEW

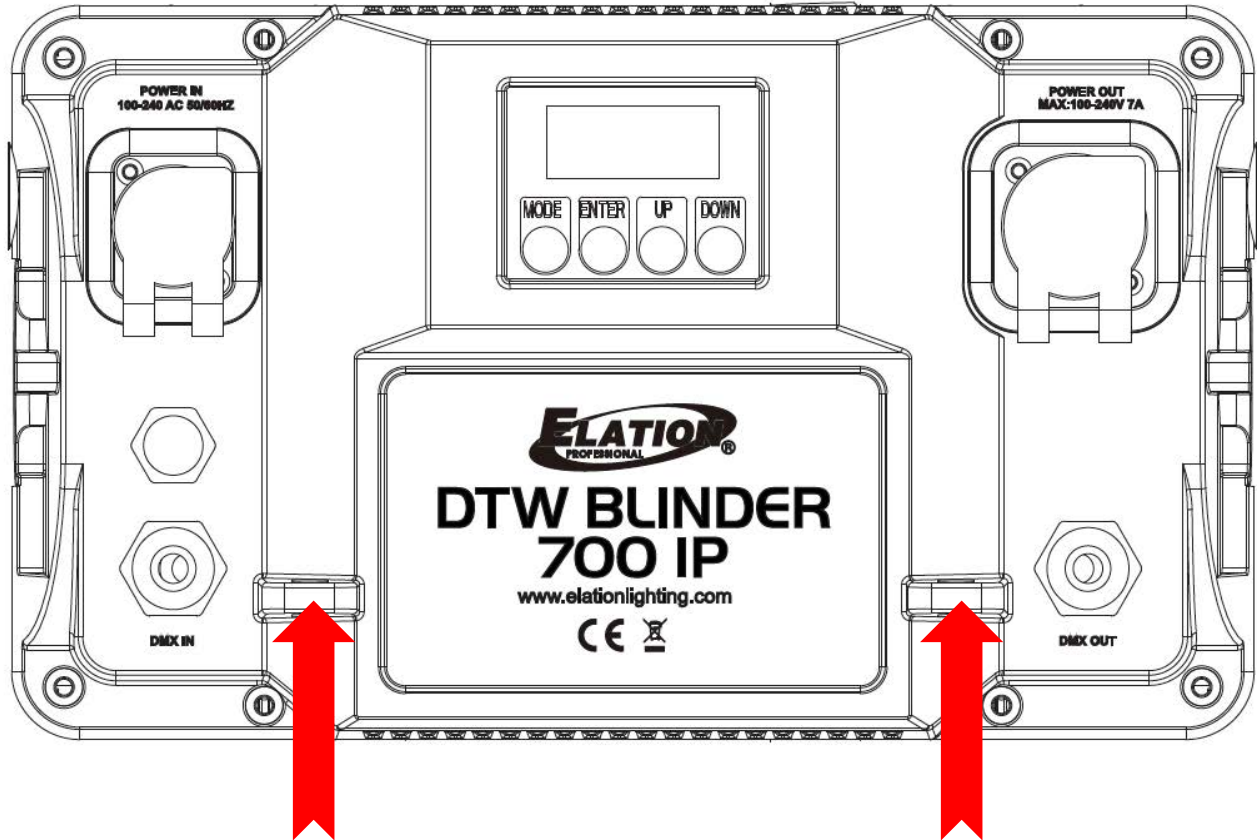

SAFETY CABLE RIGGING POINTS

INSTALLATION



FLAMMABLE MATERIAL WARNING

Keep fixture at least 5.0 ft (1.5m) away from any flammable materials, decorations, pyrotechnics, etc.



ELECTRICAL CONNECTIONS

A qualified electrician should be used for all electrical connections and/or installations.

CAUTIONS



ENSURE ALL CONNECTIONS AND END CAPS ARE PROPERLY SEALED WITH A DIELECTRIC GREASE (AVAILABLE AT MOST ELECTRICAL SUPPLIERS) TO PREVENT WATER CORROSION AND/OR ELECTRICAL SHORT CIRCUIT.

- For added protection, mount the fixture in areas outside walking paths, seating areas, or in areas where unauthorized personnel might reach the fixture.
- Ambient operating temperature range for this fixture is **5° to 113°F. (-15° to 45°C)**
Do not use the fixture under or above this temperature.
- Before mounting the fixture to any surface, make sure the installation area can hold a minimum point load of 10 times the weight of the fixture.
- Fixture installation must always be secured with a secondary safety attachment, such as an appropriate safety cable.
- Never stand directly below the device when mounting, removing or servicing.

CLAMP INSTALLATION

The fixture provides an integrated mounting bracket / yoke. When mounting this fixture to truss be sure to secure an appropriately rated clamp to the mounting bracket / yoke using a M10 screw fitted through the center hole. Be sure to attach an appropriate **Safety Cable** (not included) to the fixture using the safety cable rigging point integrated into the back of the fixture.

RIGGING

Overhead rigging requires extensive experience, including amongst others calculating working load limits, installation material being used, and periodic safety inspection of all installation material and the fixture. If you lack these qualifications, do not attempt the installation yourself. Improper installation can result in bodily injury. Fixture is fully operational in the specific mounting positions illustrated below.

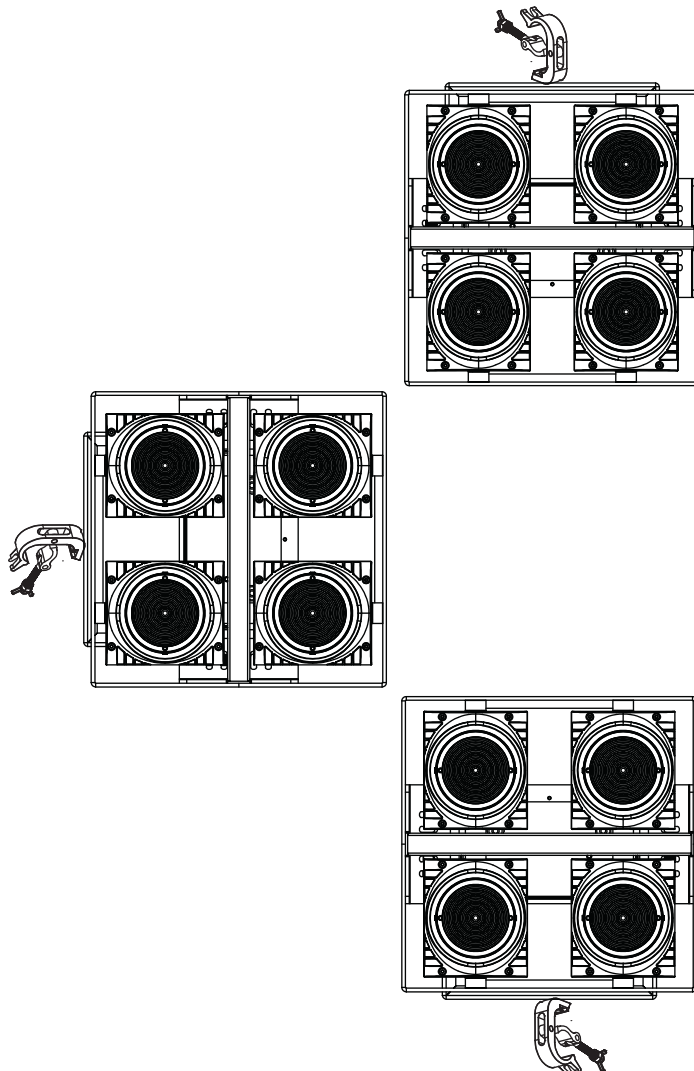

S A F E T Y C A B L E

**ALWAYS USE A SAFETY CABLE
WHENEVER INSTALLING THIS FIXTURE
IN A SUSPENDED ENVIRONMENT TO
ENSURE THE FIXTURE WILL NOT DROP IF
THE CLAMP FAILS.**

CONNECTOR PANEL

The Connector Panel Set is a set of plates that can be used to connect two DTW Blinder units together.

Connector Panels are compatible with both DTW Blinder 350 IP and DTW Blinder 700 IP models. Connector Panels may be used to connect two units of the same model type (for example, a 350 IP to a 350 IP, or a 700 IP to a 700 IP), or they may be used to connect one unit of each model type (for example, a 350 IP and a 700 IP).

The maximum number of units that may be connected using the Connector Panels are as follows:

- DTW Blinder 350 IP: 3 units max
- DTW Blinder 700 IP: 2 units max

DO NOT EXCEED THIS MAXIMUM NUMBER OF UNITS!

Always make sure to use a secondary safety cable when installing this fixture in a suspended environment. The safety cable should be used to link the designated attachment point on the device to a secure mounting point or section of trussing. This will ensure that the fixture will not fall in the event that the mounting clamp fails.

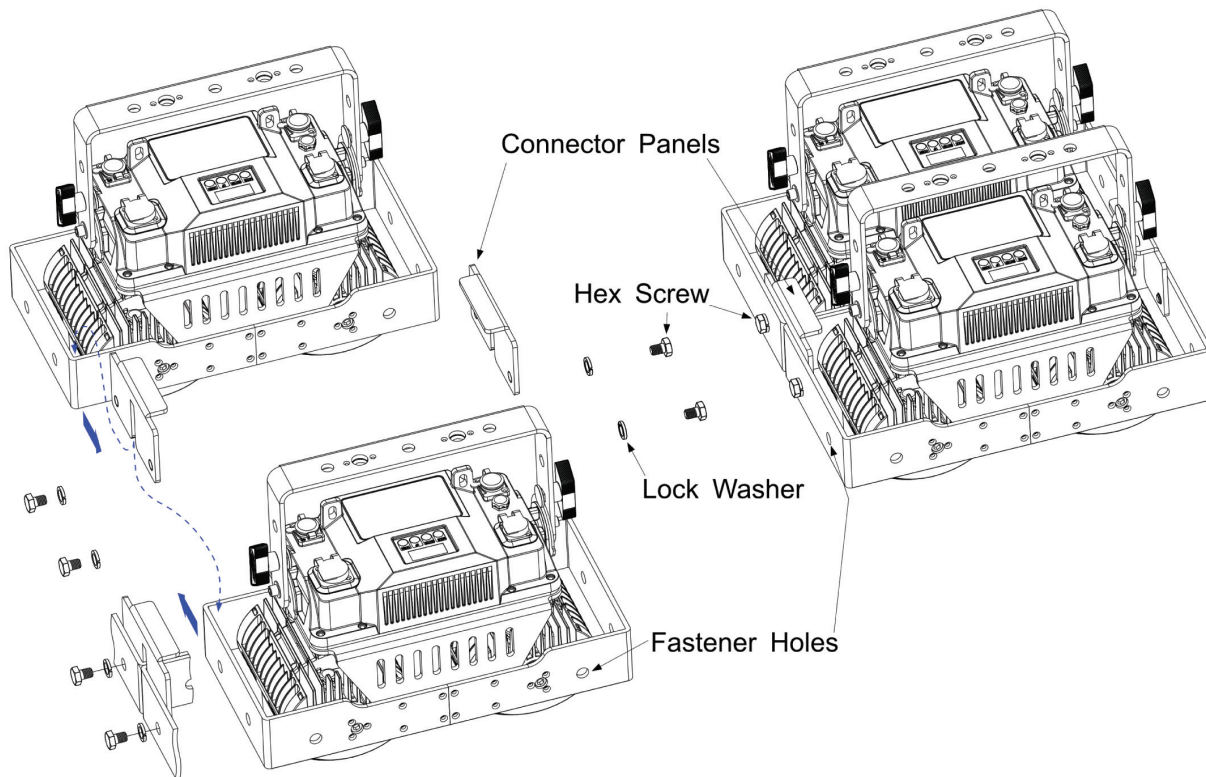

25° NARROW BEAM FRESNEL FILTER INSTALLATION

1. Hold lens filter in front of the COB module so that both small black raised plastic tabs are positioned horizontal at 9 and 3 o'clock. (See image below left)

2. Insert lens into COB module. (See image below right)

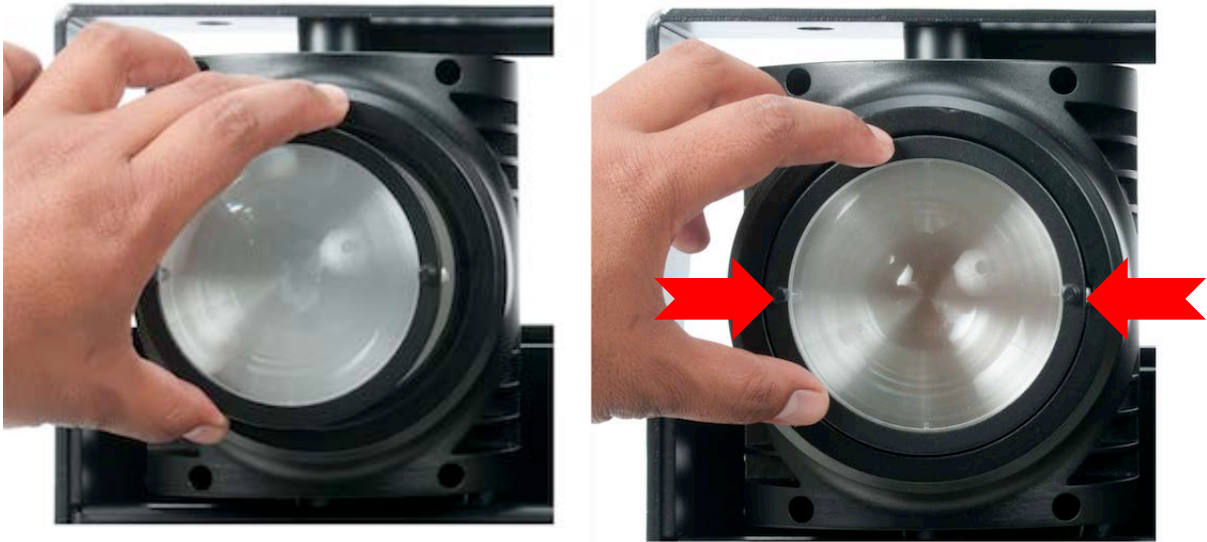

3. While applying gentle pressure against the lens, slowly turn the lens counter-clockwise a $\frac{1}{4}$ turn, until both small black raised plastic tabs are positioned vertical at 12 and 6 o'clock. (See image below)



ENSURE ALL LENS FILTERS ARE SECURELY INSTALLED AS ILLUSTRATED ABOVE BEFORE THE FIXTURE IS INSTALLED ON TRUSS AND/OR RIGGING.

POWER LINKING

Max number of **DTW BLINDER 700 IP™** units power linked together:

1 units @120V | 2 units @240V



NOTE: USE CAUTION WHEN POWER LINKING OTHER FIXTURES TO DTW BLINDER 700 IP™!

POWER CONSUMPTION OF OTHER LIGHTING FIXTURES WILL VARY!

ALWAYS CHECK MAX AMP OUT RATING PRINTED ON THE REAR CONNECTION PANEL!

SOFTWARE UPDATES

For optimal operation, this fixture may require improved software. Compare the software shown during boot-up or in the display menu against the version number indicated at the start of this document.

The DTW Blinder 700 IP can be updated through the DMX cable using the C-Loader device, which can be purchased from Elation Professional.

The latest software is available for download from the DTW Blinder 700 IP product page. Please review and follow the update instruction outlined in the C-Loader user manual.

SYSTEM MENU

The fixture comes with an easy to navigate system menu. The control panel (see image below) located on the front the fixture provides access to the main system menu and is where all necessary system adjustments are made to the fixture. During normal operation, pressing **MODE** button once will access the fixture's main menu. Once in the main menu you can navigate through the different functions and access the sub-menus with the **UP** and **DOWN** buttons. Once you reach a field that requires adjusting, press the **ENTER** button to activate that field and use the **UP** and **DOWN** buttons to adjust the field. Pressing the **ENTER** button once more will confirm your setting. You may exit the main menu at any time without making any adjustments by pressing the **MODE/ESC** button.

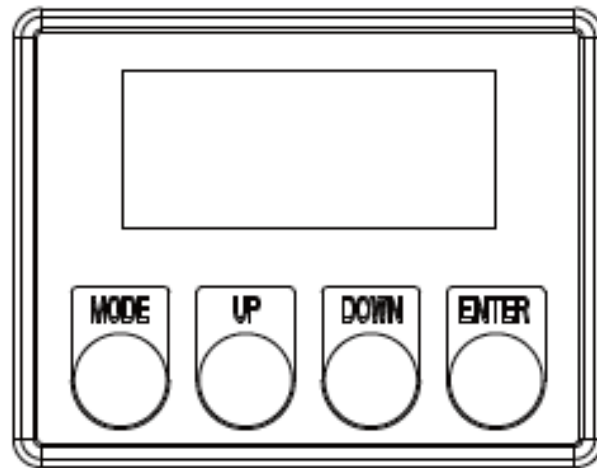

LCD CONTROL PANEL LOCKOUT FEATURE

When the **AUTO LOCK** menu is set to **ON** (default setting); the LCD control panel display will turn OFF and become LOCKED after non-use. To UNLOCK, press the **ENTER** button followed by pressing and holding the **MODE** button until the LCD control panel display is UNLOCKED.

When the **AUTO LOCK** menu is set to **ON1** and is LOCKED, follow these steps to UNLOCK:

1. When locked, the display will show: **LOCKED*******
2. Press **UP**, then the display will change to: **LOCKED****** (one * disappears)
3. Press **DOWN**, then the display will change to: **LOCKED***** (two * disappear)
4. Press **UP**, then the display will change to: **LOCKED**** (three * disappear)
5. Press **DOWN**, then the display will change to: **LOCKED*** (4 * disappear)
6. Press **ENTER**, then the display will change to **LOCKED** and then become unlocked.

INFORMATION DISPLAYED DURING INITIAL POWER ON

When the fixture is initially powered ON, the display shows the following information:

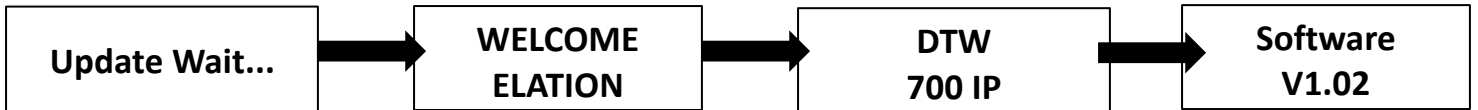

ELATION® DTW BLINDER 700 IP™ SYSTEM MENU			
Features are subject to change without any prior written notice.			
MAIN MENU	SUB MENU OPTIONS / VALUES (Default Settings in BOLD)	DESCRIPTION	
DMX ADDR	001 ~ 512	Set the DMX Address	
DMX Mode	01CH , Standard, Extended, 2CH, 4Cell, 4WA, Basic	Set DMX Channel / User Mode	
SECONDRY MODE		Secondary Mode	
STATIC	Dim	000 - 255	Set Manual Dimmer Value
	Flash	000 - 255	Set Manual Strobe Value
	WW	000 - 255	Set Manual Warm White Value
	Amber	000 - 255	Set Manual Amber Value
FADING	SPEED:	00 - 99	Set Fading Program Speed
	FLASH:	000 - 255	Set Fading Program Flash Rate
DIMMER	Standard , Tungsten, Stage, TV, Architec, Theatre, Stage2, 0-10s	Set Dimmer Curve Mode	
WHITEBAL	WW1:	050 - 255	Set WW Balance Value for Pixel #1
	A1:	050 - 255	Set Amber Balance Value for Pixel #1
	WW2:	050 - 255	Set WW Balance Value for Pixel #2
	A2:	050 - 255	Set Amber Balance Value for Pixel #2
	WW3:	050 - 255	Set WW Balance Value for Pixel #3
	A3:	050 - 255	Set Amber Balance Value for Pixel #3
	WW4:	050 - 255	Set WW Balance Value for Pixel #4
	A4:	050 - 255	Set Amber Balance Value for Pixel #4
NO DMX	Hold / Blackout	Function If NO DMX Detected	
AUTOLOCK	ON / ON1 / OFF	Control Front Panel Buttons Key Lock - ON: Unlock by pressing MODE for 3s - ON1: Press UP, DOWN, UP, DOWN, ENTER to unlock	
DIMCURVE	Linear, Square, Inv. Squa, S-Curve	Set Dimming Curve	
DTW	On , Off	Set DTW Setting	
TEMPUNIT	F , °C	Temperature Display F/ C°	
SYSTEM TEMP	LED1	XXX °F / °C	Displays temp of LED1
	LED2	XXX °F / °C	Displays temp of LED2
	LED3	XXX °F / °C	Displays temp of LED3
	LED4	XXX °F / °C	Displays temp of LED4
FAN SET	Auto , High, Silent	Select fan setting	
LED_FREQ	0.9KHz~25KHz (Default: 1.2 KHz)	Set LED Refresh Rate	
CELLORDR	Standard , Inverted, Rotated, Snake, Snake Inverted, Snake Rotated	Configure cell order (see following page for cell order diagrams)	
Default	OFF / ON	Restore Factory Settings	

CELL ORDER DIAGRAMS

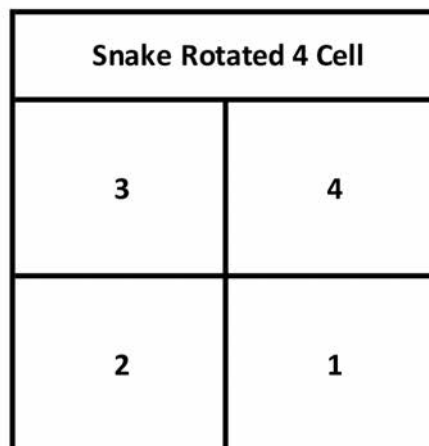
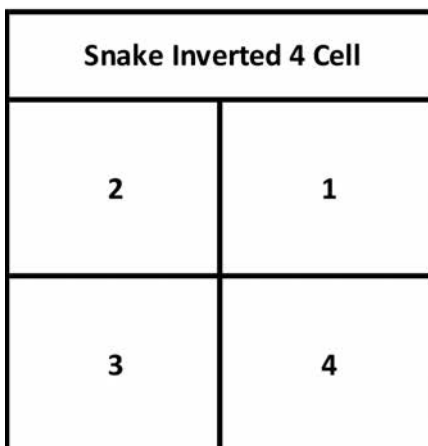
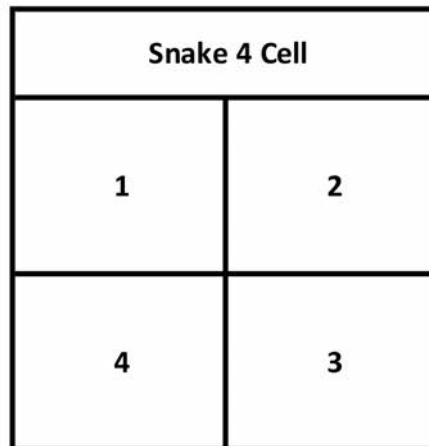
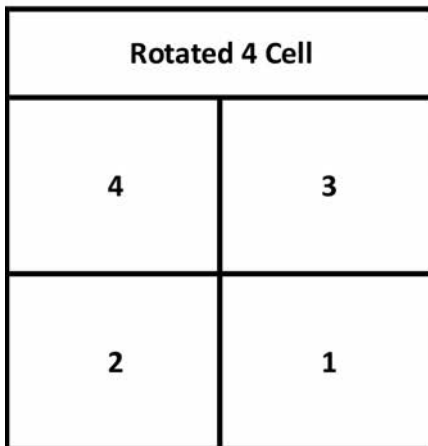
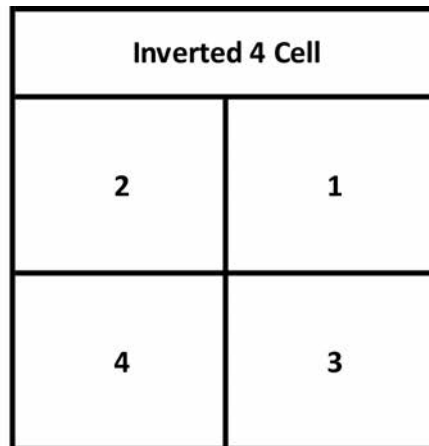
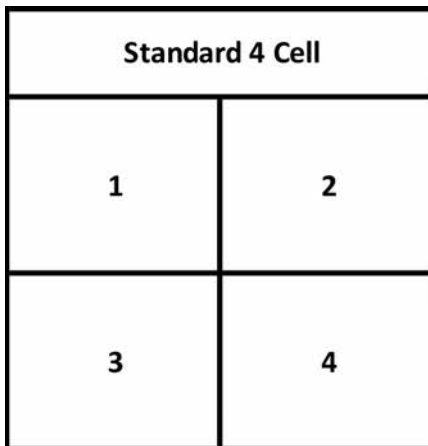

DMX CHANNEL FUNCTIONS AND VALUES

ELATION DTW BLINDER 700 IP							DMX Channel Values / Functions	
Features are subject to change without any prior written notice. *Control of Pixels depends on the fixture installation orientation.								
DMX CHANNEL MODE							DMX VALUE	FUNCTION
1CH	Standard	Extended	2CH	4Cell	4WA	Basic		
	1	1						Strobe 0 - 31 Closed 32 - 63 Open 64 - 95 Strobe, slow to fast 96 - 127 Open 128 - 159 Pulse, slow to fast 160 - 191 Open 192 - 223 Random, slow to fast 224 - 255 Open
1	2	2				1	0 - 255	Master Intensity , Closed to Open
	3	3				2	0 - 255	Master Intensity Fine , Closed to Open
								Dim Modes 0 - 10 Standard 11 - 20 Tungsten (default) 21 - 40 Stage 41 - 60 TV 61 - 80 Architectural 81 - 100 Theatre 101 - 120 Stage 2 Dimmer Delay Time 121 0s 122 0.1s 123 0.2s 124 0.3s 125 0.4s 126 0.5s 127 0.6s 128 0.7s 129 0.8s 130 0.9s 131 1.0s 132 1.5s 133 2.0s 134 3.0s 135 4.0s 136 5.0s 137 6.0s
	4	4						

CONTINUED ON NEXT PAGE

DMX CHANNEL FUNCTIONS AND VALUES

ELATION DTW BLINDER 700 IP							DMX Channel Values / Functions	
Features are subject to change without any prior written notice. *Control of Pixels depends on the fixture installation orientation.								
DMX CHANNEL MODE							DMX VALUE	FUNCTION
1CH	Standard	Extended	2CH	4Cell	4WA	Basic		
	4 <i>(cont'd from prev page)</i>	4 <i>(cont'd from prev page)</i>						Dimmer Delay Time <i>(cont'd from prev page)</i>
							138	7.0s
							139	8.0s
							140	9.0s
							141	10s
							142 - 255	Default
								Control
							0 - 4	Idle
							5 - 6	Fan Silent
							7 - 8	Fan Auto (default)
							9 - 10	Fan High
								Change Cell Order, hold 3s
							11 - 15	Standard (default)
							16 - 20	Inverted
							21 - 25	Idle
							26 - 30	Snake
							31 - 35	Snake Inverted
							36 - 40	Snake Rotated
							41 - 100	Idle
								Change Refresh Rate (Hz), Instant
							101 - 105	900
							106 - 110	1000
							111 - 115	1100
							116 - 120	1200 (default)
							121 - 125	1300
							126 - 130	1400
							131 - 135	1500
							136 - 140	2500
							141 - 145	4000
							146 - 150	5000
							151 - 160	10000
							161 - 165	15000
							166 - 170	20000
							171 - 175	25000
							176 - 200	Idle
CONTINUED ON NEXT PAGE								

DMX CHANNEL FUNCTIONS AND VALUES

ELATION DTW BLINDER 700 IP DMX Channel Values / Functions								
Features are subject to change without any prior written notice. <i>*Control of Pixels depends on the fixture installation orientation.</i>								
DMX CHANNEL MODE							DMX VALUE	FUNCTION
1CH	Standard	Extended	2CH	4Cell	4WA	Basic		
	5 (cont'd from prev page)	5 (cont'd from prev page)						<i>Dimmer Curves, hold 3s</i>
							201 - 210	Linear
							211 - 220	Square
							221 - 230	Inverse Square
							231 - 240	S-Curve (default)
								<i>DTW Mode</i>
							241 - 245	Dim to Warm Enabled (default)
							246 - 250	Dim to Warm Disabled
							251 - 255	Idle
	6		1			3	0 - 255	<i>White, All Cells, 0-100%</i>
	7		2			4	0 - 255	<i>Amber, All Cells, 0-100%</i>
		6		1	1		0 - 255	<i>White/DTW, Cell 1, 0-100%</i>
		7			2		0 - 255	<i>Amber, Cell 1, 0-100%</i>
		8		2	3		0 - 255	<i>White/DTW, Cell 2, 0-100%</i>
		9			4		0 - 255	<i>Amber, Cell 2, 0-100%</i>
		10		3	5		0 - 255	<i>White/DTW, Cell 3, 0-100%</i>
		11			6		0 - 255	<i>Amber, Cell 3, 0-100%</i>
		12		4	7		0 - 255	<i>White/DTW, Cell 4, 0-100%</i>
		13			8		0 - 255	<i>Amber, Cell 4, 0-100%</i>

DIM TO WARM FEATURES

DTW MODE (CONTROL CHANNEL)

This feature can be enabled or disabled via DMX control, or via the display screen on the back of the device.

- **Disabled:** Amber and White function independently, allowing each color to be adjusted separately without affecting the other color.
- **Enabled:** The adjustment of Amber and White are linked together in such a way as to emulate the warming up of a tungsten fixture. As the White levels are adjusted, Amber will automatically be mixed in as needed. Any previously set or manually entered Amber levels will be overridden.

DIMMER CURVES

Dimmer Curves correlate a DMX value to a specific light output level of the fixture. Four curves are available and allow the user to tailor the performance of the fixture to his or her needs:

- Linear
- Square
- Inverse Square
- S-Curve (Default)

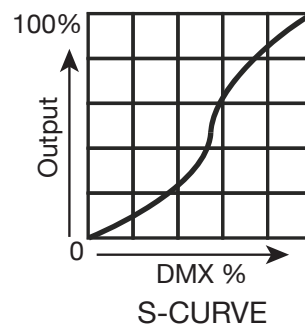
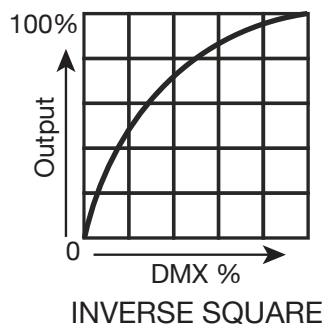
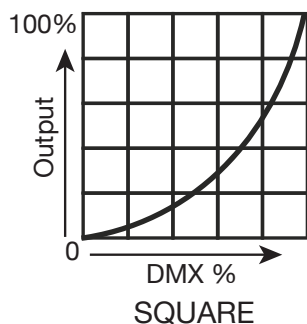
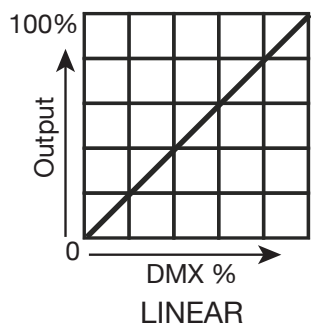

The S-Curve Dimmer Curve is ideal for controlling a blinder-type fixture, as it features a smooth bottom and has no harsh reduction in lighting intensity when fading down from 100% output. When operating in a DTW-enabled setting with manual fader control, the S-Curve will provide the most natural feel.

DIM TO WARM FEATURES

DIM MODES

The Dim Modes control the timing of fixture lighting according to predefined curves or timing delays. This aids in smoothing out the dimming behavior of the fixture, allowing it to emulate the naturally occurring dimming patterns of conventional lighting fixtures.

7 distinct modes are available:

- Standard (no timing delay)
- Tungsten (default setting for DTW fixture)
- Stage
- Stage2
- Architectural
- Theatre
- 0-10s Delay

Tungsten Mode is the default setting for DMX channel modes that do not include a Dim Mode control channel. By contrast, for DMX channel modes that include a Dim Mode control channel, the default Dim Mode is Standard. In this case, the user can still opt for dimming behavior that emulates a tungsten fixture by setting the Dim Mode channel to a DMX value of 15. The Dim Mode channel must remain at this value for as long as this effect is desired.

Experimentation with the different Dim Modes is highly encouraged, in order to determine which mode best suits the requirements of the application. Dim Modes impact only the timing of lighting intensity changes and have no effect on the dimmer output curve or color shift. Dim Modes change instantly when selected and remain active only as long as the relevant DMX channel is held at the specified value.

Please refer to the chart on the following page for details.

DIM TO WARM FEATURES

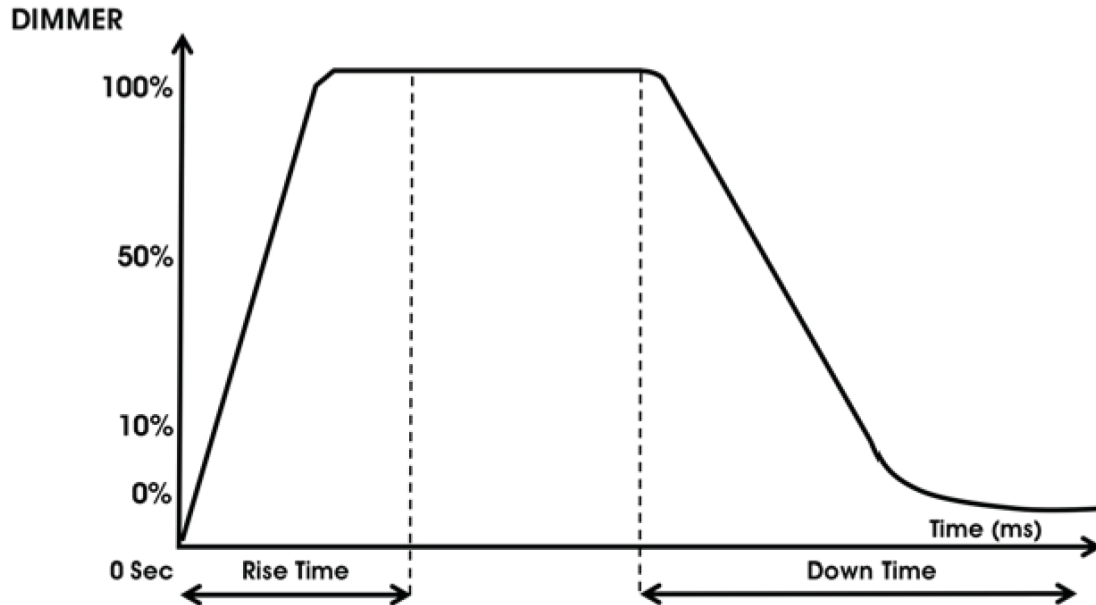

	0 sec Fade Time		1 sec Fade Time	
Dimming Curve Ramp Effect				
	Rise Time (ms)	Down Time (ms)	Rise Time (ms)	Down Time (ms)
Standard (default)	0	0	0	0
Stage	780	1100	1540	1660
TV	1180	1520	1860	1940
Architectural	1380	1730	2040	2120
Theatre	1580	1940	2230	2280
Stage 2	0	1100	0	1660
Tungsten	200	700	1200	1700

CLEANING AND MAINTENANCE



C A U T I O N

Disconnect power before cleaning or maintenance.

CLEANING

Frequent cleaning is recommended to insure proper function, optimized light output, and an extended life. The frequency of cleaning depends on the environment in which the fixture operates: damp, smoky or particularly dirty environments can cause greater accumulation of dirt on the fixture's optics.

- Clean the external lens surface at least every 20 days with a soft cloth to avoid dirt/debris accumulation.
- Never use alcohol, solvents, or ammonia based cleaners.

MAINTENANCE

Regular inspections are recommended to insure proper function and extended life.

There are no user serviceable parts inside this fixture, please refer all other service issues to an authorized Elation service technician. Should you need any spare parts, please order genuine parts from your local Elation dealer.

Please refer to the following points during routine inspections:

- A detailed electric check by an approved electrical engineer every three months, to make sure the circuit contacts are in good condition and prevent overheating.
- Be sure all screws and fasteners are securely tightened at all times. Loose screws may fall out during normal operation resulting in damage or injury as larger parts could fall.
- Check for any deformations on the housing, color lenses, rigging hardware and rigging points (ceiling, suspension, trussing). Deformations in the housing could allow for dust to enter into the fixture. Damaged rigging points or unsecured rigging could cause the fixture to fall and seriously injure a person(s).
- Electric power supply cables must not show any damage, material fatigue or sediments. Never remove the ground prong from the power cable.

TECHNICAL SPECIFICATIONS

SOURCE

(4) 175W 2-in-1 Warm White / Amber COB LEDs

50,000 Hour Average LED Life*

*May vary depending on several factors including but not limited to:
Environmental Conditions, Power/Voltage, Usage Patterns (On-Off Cycling), Control, and Dimming.

COLOR

Warm White / Amber

EFFECTS

Pixel Control

Independent Dim-To-Warm Channel Control (1,800K - 3,200K)

Electric Strobe and Variable Dimming Curves Modes

CONTROL / CONNECTIONS

9 DMX Channel Modes (13 Total Channels)

4 Touch Button Control Panel and LCD Menu Display

RDM (Remote Device Management)

IP rated 5pin DMX and Power In/Out

SIZE / WEIGHT

Length: 15.7" (400mm)

Width: 9.5" (241mm)

Horizontal Height: 16.14" (410mm)

Weight: 28.0 lbs. (12.7 kg)

ELECTRICAL / THERMAL

AC 100-240V - 50/60Hz

680W Max Power Consumption

5F to 113°F (-15°C to 45°C)

APPROVALS / RATINGS

CE | IP65



Please Note: Specifications and improvements in the design of this unit and this manual are subject to change without any prior written notice.

DIMENSIONAL DRAWINGS

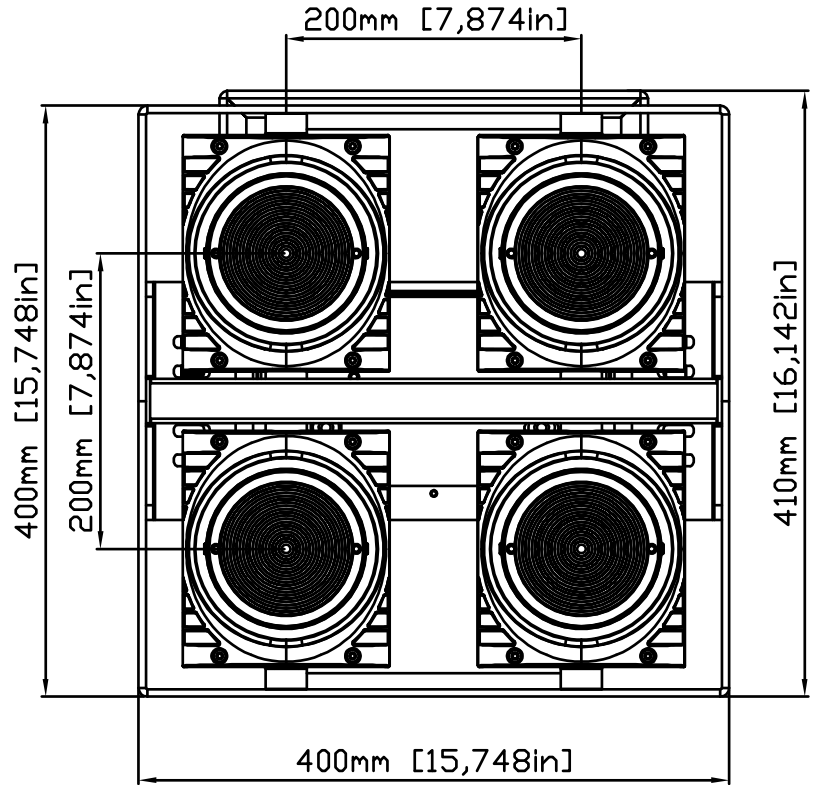
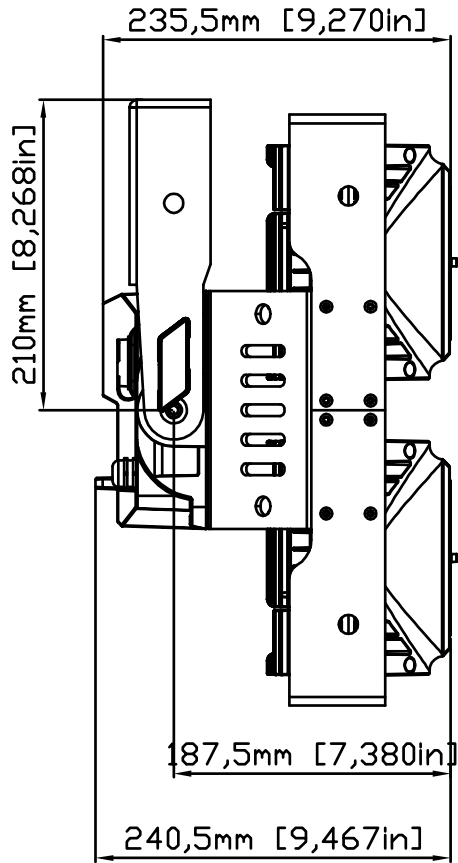

Please Note: Specifications and improvements in the design of this unit and this manual are subject to change without any prior written notice.

OPTIONAL ACCESSORIES

ORDER CODE	ITEM
TRIGGER CLAMP	Heavy Duty Wrap Around Clamp
8050000053	Omega Bracket (107mm)
NEU088	3 ft. (1m) Power Cable (additional cable lengths available)
C-Loader	C-LOADER Software Uploader

