

RoHS COMPLIANT



Bittree PATCHING SYSTEMS

AUDIO, VIDEO, DATA
600 WEST ELK AVENUE
GLENDALE, CA. 91204
TEL 818 500-8142
FAX 818 500-7062
WWW.BITTREE.COM

DATA CONTAINED IN THIS DOCUMENT IS PROPRIETARY AND SHALL NOT BE DISCLOSED, COPIED OR USED FOR PROCUREMENT OR MANUFACTURE WITHOUT EXPRESS WRITTEN PERMISSION OF BITTREE INCORPORATED

DWG. NO.: B96DCHNRSHE3M20U7B
PART NO.: B96DC-HNRSH/E3 M20U7B
DESIGNATION: DS800-10-ASSY

LAYER (DS_INSERT) IS PROVIDED FOR THE CREATION OF LEGEND STRIPS FOR THIS PATCHBAY. THE RED OUTLINE MATCHES THE SIZE OF INSERT. PLEASE NOTE THE VIEWABLE AREA IS LISTED IN NOTES BELOW THE FRONT PANEL VIEW.

DWG. SCALE: FULL

PDF. SCALE: NONE

ALL POSSIBLE CARE HAS BEEN TAKEN IN PREPARING THIS SET OF DRAWINGS. STATEMENTS AND SPECIFICATIONS ARE BELIEVED TRUE BUT CANNOT BE GUARANTEED AND THEREFORE WE ARE NOT RESPONSIBLE FOR ANY INACCURACIES. THIS DOCUMENT SHOULD BE USED AS THE BASIS FOR DESIGN OR TO ESTABLISH SPECIFICATION LIMITS.

BITTREE RESERVES THE RIGHT TO CHANGE OR ALTER SPECIFICATIONS OR MATERIALS WITHOUT NOTICE. PROVIDED THE FUNCTION AND PERFORMANCE OF THE PRODUCT REMAINS REASONABLY SIMILAR OR IS IMPROVED.

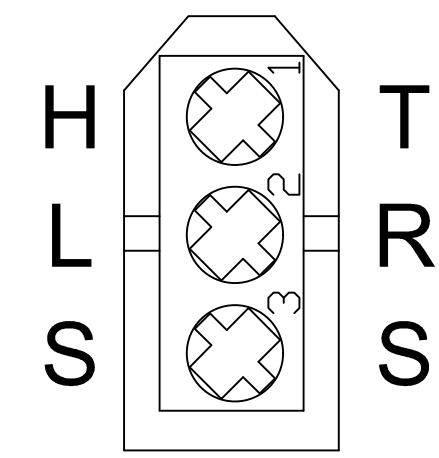

BITTREE 3 PIN CONNECTOR
REAR VIEW PIN-OUT

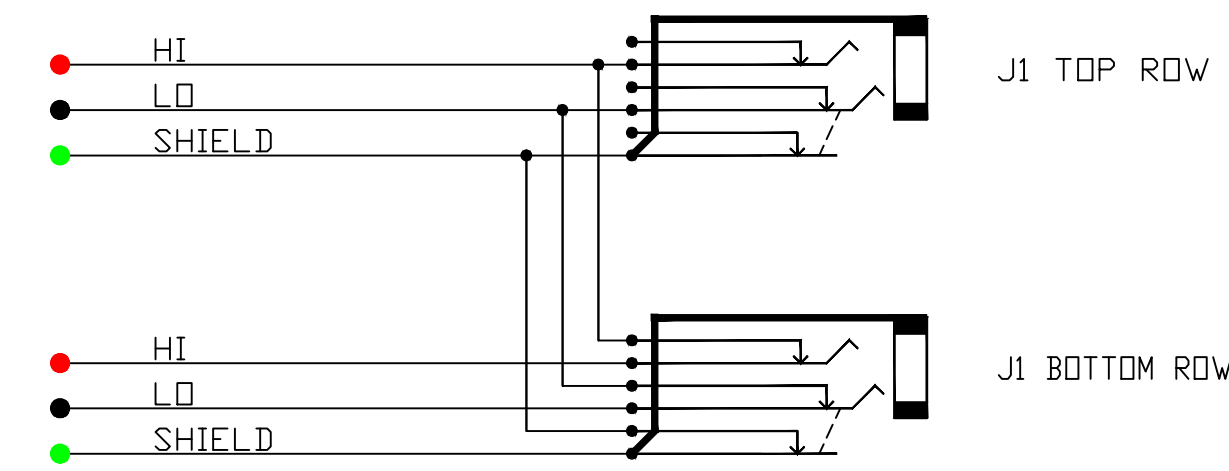

SCHEMATIC
HALF-NORMALIZED SWITCHED GND VIEW

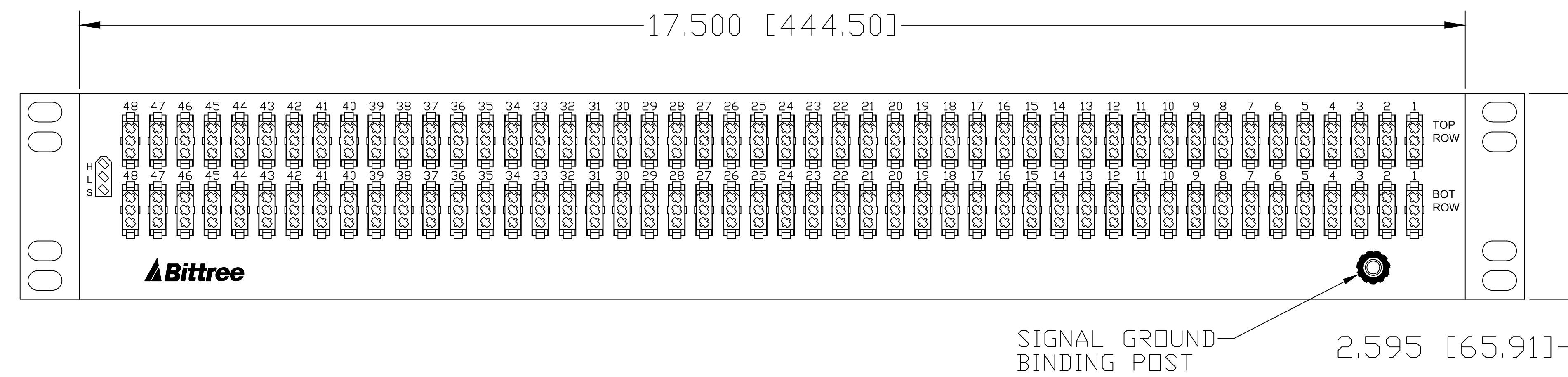

REAR VIEW

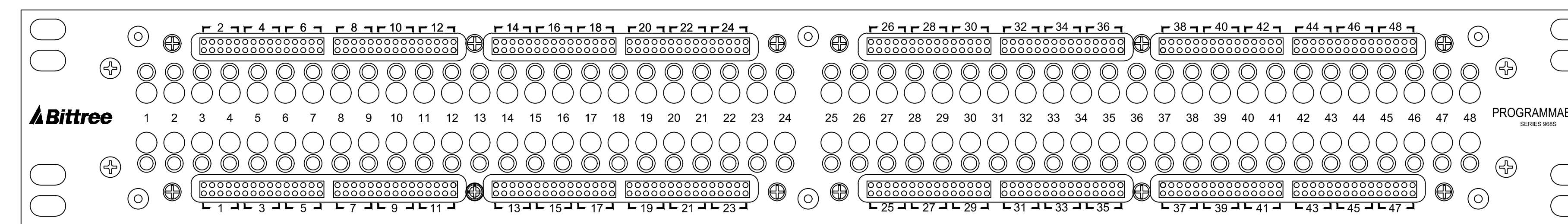

FRONT VIEWS

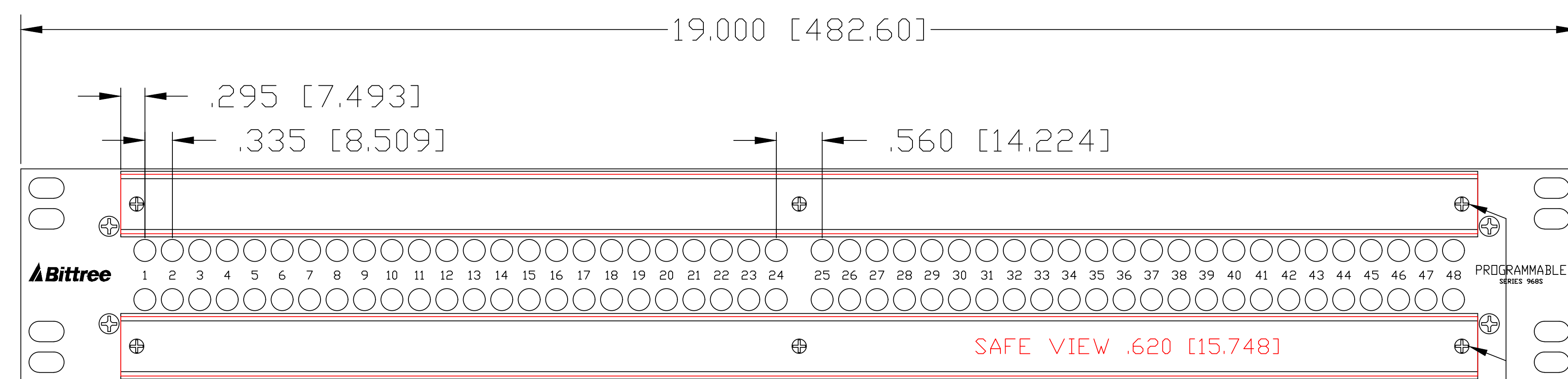

DESIGNATION:	PART NBR.	DIMENSIONS
STAINLESS STEEL HOLDERS:	DS800-10/S,	.800 [20.320] x 16.560 [420.624]
TRANSLUCENT LEXAN INSERTS:	DS800-10/P,	.725 [18.415] x 16.560 [420.624]
WHITE STYRENE INSERTS:	DS800-10/D,	.725 [18.415] x 16.560 [420.624]

NOTE: DS_INSERT LAYER IS A SCALED 1:1 LABEL INSERT OUTLINE

TOOLS AND ACCESSORIES PART NUMBERS

DESCRIPTION	PART NUMBER
CONTACT CRIMP TOOL	K2MA-01
CONTACT REMOVAL TOOL	516-280-300
CONTACT INSERTION TOOL	516-280-400
BITTREE MALE CONNECTOR	E3M
BITTREE FEMALE CONNECTOR	E3F
CONNECTOR CONTACTS (PINS)	EPIN
REPLACEMENT HARDWARE KIT	9603R
PROGRAMMING SHUNTS (RED)	382811-9
PROGRAMMING SHUNTS (WHITE)	382811-0
LACING BAR 6IN (152.4MM)	LB-17500
LACING BAR 3IN (76.2MM)	LB175-3

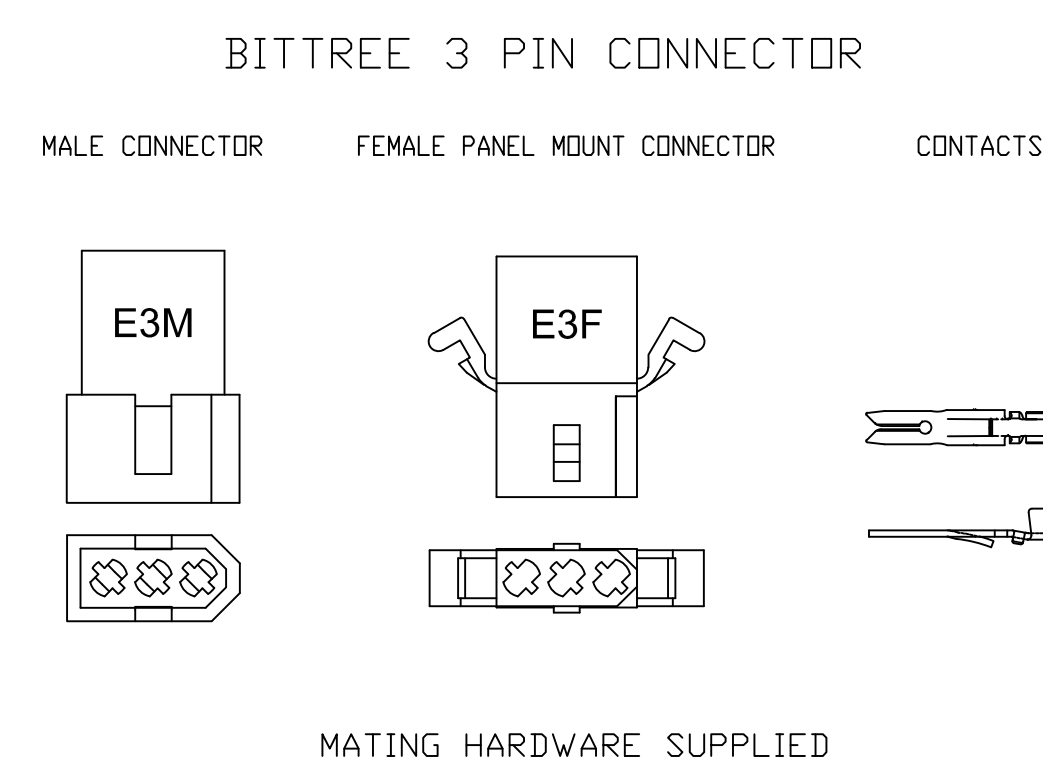

MATING HARDWARE SUPPLIED
FOR PURCHASE OF ADDITIONAL MATING HARDWARE
SEE ACCESSORIES DRAWING FOR PART NUMBERS.

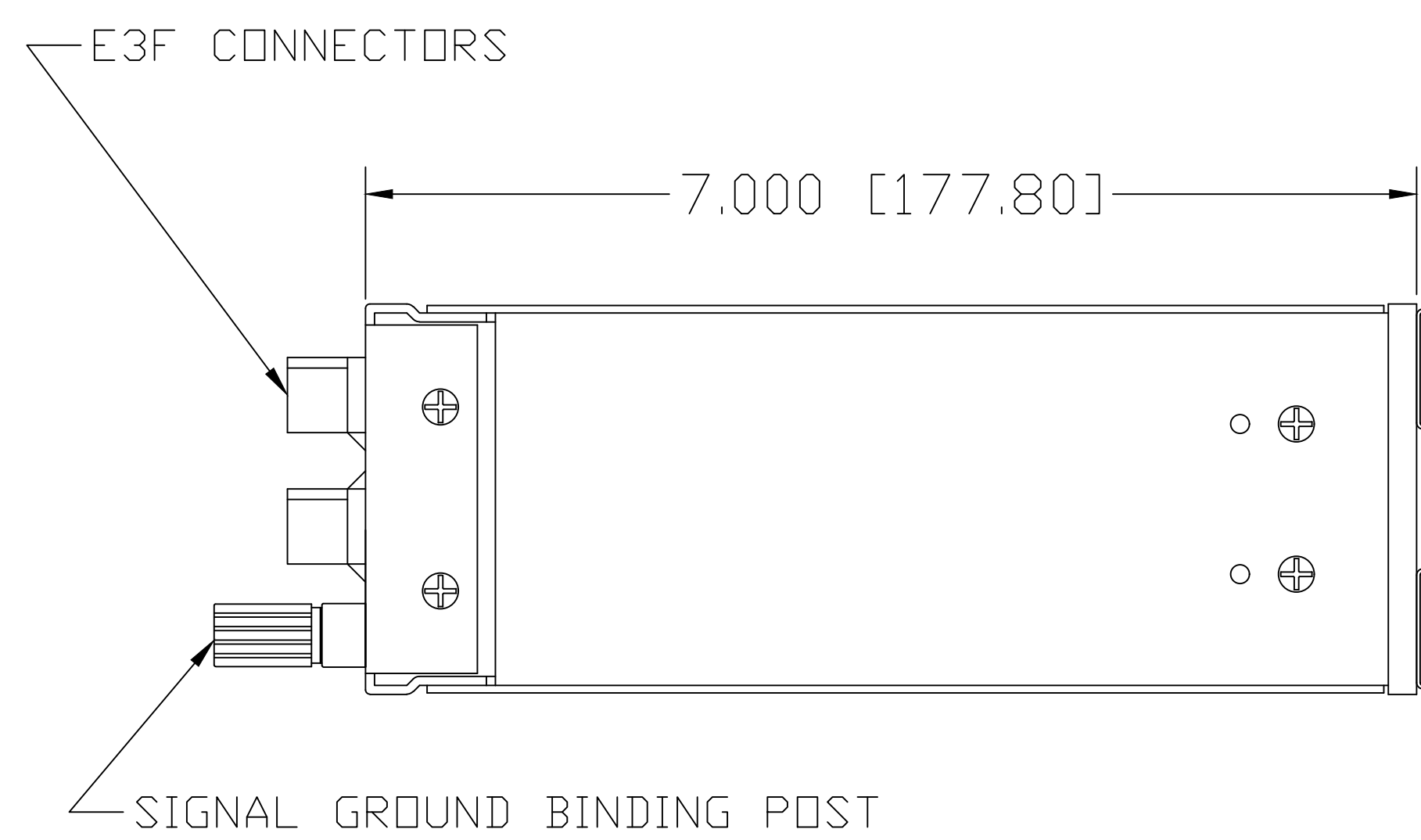

LEFT SIDE VIEW

REV.:	DATE: 10/26/2017	BY: G.S.	CHANGES:
-------	------------------	----------	----------