

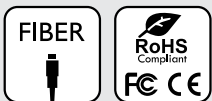

AV Connectivity, Distribution And Beyond...

**VIDEO WALLS VIDEO PROCESSORS**  
**VIDEO MATRIX SWITCHES**  
**EXTENDERS SPLITTERS WIRELESS**  
**CABLES & ACCESSORIES**

## **50/125 $\mu$ m Fiber Optic Patch Multimode Simplex SC to SC 10Gb OM3 Aqua**

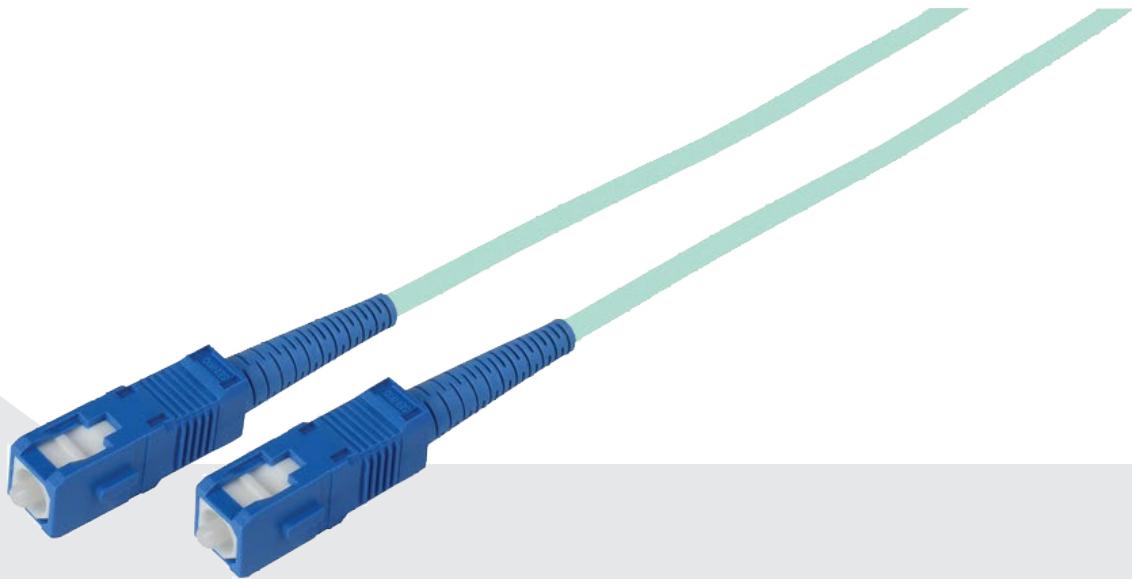

**Model #: FO-MMS-SC-SC-XX**

© 2013 Avenview Inc. All rights reserved.

The contents of this document are provided in connection with Avenview Inc. ("Avenview") products. Avenview makes no representations or warranties with respect to the accuracy or completeness of the contents of this publication and reserves the right to make changes to specifications and product descriptions at any time without notice. No license, whether express, implied, or otherwise, to any intellectual property rights is granted by this publication. Except as set forth in Avenview Standard Terms and Conditions of Sale, Avenview assumes no liability whatsoever, and claims any express or implied warranty, relating to its products are strictly prohibited.

## Product Application & Market Sectors



Corporate



House Of Worship



Military



Residential



Education



Industrial



Medical



Aviation



## TABLE OF CONTENTS

1.	GETTING STARTED .....	1
1.1	IMPORTANT SAFEGUARDS.....	1
1.2	SAFETY INSTRUCTIONS .....	1
1.3	REGULATORY NOTICES FEDERAL COMMUNICATIONS COMMISSION (FCC) .....	2
2.	INTRODUCTION .....	3
	FEATURES .....	3
2.1	PACKAGE CONTENTS .....	3
3.	FIBER DESCRIPTION.....	4
4.	INSTALLATION.....	5
	REMOVING A PATCH CORD .....	5
	ADDING A PATCH CORD .....	5
5.	SPECIFICATIONS.....	6
	OPTICAL FIBER HAZARD.....	6
	NOTES .....	8



## SECTION I: GETTING STARTED

### I.1 IMPORTANT SAFEGUARDS

Please read all of these instructions carefully before you use the Fiber Optic cable. Save this manual for future reference.

#### What the warranty does not cover

- Any product, on which the serial number has been defaced, modified or removed.
- Damage, deterioration or malfunction resulting from:
- Accident, misuse, neglect, fire, water, lightning, or other acts of nature, unauthorized product modification, or failure to follow instructions supplied with the product.
- Repair or attempted repair by anyone not authorized by us.
- Any damage of the product due to shipment.
- Removal or installation of the product.
- Causes external to the product, such as electric power fluctuation or failure.
- Use of supplies or parts not meeting our specifications.
- Normal wear and tear.
- Any other causes which does not relate to a product defect.
- Removal, installation, and set-up service charges.

### I.2 SAFETY INSTRUCTIONS





The Multimode Duplex SC to SC Fiber Optic Patch Cable OM3 50/125u 10-Gig Aqua has been tested for conformance to safety regulations and requirements, and has been certified for international use. However, like all Fiber Optic products, the FO-MMS-SC-SC-XX should be used with care. Read the following safety instructions to protect yourself from possible injury and to minimize the risk of damage to the unit. On no account should you:

- ⚠ Look into a fiber while the system lasers are on;
- ⚠ Use unfiltered handheld magnifiers or focusing optics to inspect fiber connectors;
- ⚠ Connect a fiber to a fiberscope while the system lasers are on;
- ⚠ Touch the end of the fiber connectors;
- ⚠ Pull forcefully on the fiber cable;
- ⚠ Reuse any specified fiber cleaning material more than once;
- ⚠ Touch the clean area of a any specified fiber cleaning material;
- ⚠ Use alcohol around an open flame or spark - Alcohol is Very Flammable;
- ⚠ Use alcohol or wet cleaning without a way to ensure that it does not leave residue on the polished connector;
- ⚠ Dismantle the housing or modify the connector.



## 1.3 REGULATORY NOTICES FEDERAL COMMUNICATIONS COMMISSION (FCC)

This equipment has been tested and found to comply with Part 15 of the FCC rules. These limits are designed to provide reasonable protection against harmful interference in a residential installation. Any changes or modifications made to this equipment may void the user's authority to operate this equipment.

Warning symbols	Description
	<p style="text-align: center;"><b>LASER RADIATION DO NOT STARE INTO BEAM &lt; 1 MILLIWATT LASER DIODE CLASS 2 LASER PRODUCT</b></p> <p>Risk levels increase. These lasers emit a visible beam, from 400 to 780 Nanometres (nm), with an upper power limit of 1 milliwatt. An example is a (mw) bar code scanner. Momentary viewing is not hazardous, but extended viewing is. Laser protective eyewear is recommended for even momentary viewing and necessary for extended viewing</p>
	<p style="text-align: center;"><b>DO NOT TAMPER WITH THE FIBER CABLE; DOING SO WILL VOID THE WARRANTY AND CONTINUED USE OF THE PRODUCT.</b></p>
	<p style="text-align: center;"><b>LASER BEAM USED IN OPTICAL COMMUNICATIONS ARE INVISIBLE AND CAN SERIOUSLY DAMAGE THE EYES. VIEWING IT DIRECTLY DOES NOT CAUSE ANY PAIN TO THE EYE BUT SERIOUS DAMAGE CAN BE DONE TO THE RETINA OF THE EYE</b></p>
	<div style="border: 1px solid black; padding: 5px;"> <p style="background-color: orange; color: black; padding: 2px;"><b>⚠ WARNING</b></p> <p><b>Read &amp; understand user guide before using this device.</b></p> <p><b>Failure to follow the proper installation instructions could result in damage to the product and preventing expected results.</b></p> </div>

## 2. INTRODUCTION

The Professional series SC to SC OM3 10-Gb 50/125 Simplex Multimode fiber optic cables from Avenview are fully tested to ensure reliable performance in critical applications. Our SC connector fiber patch cord has its features and benefits because of its SC connector with its keyed duplexibility to support send/receive channels and easier to use than the twist-style ST connector when in tight spaces. The SC connector has a 2.5mm Ferrule and molded housing for protection. Typical matched SC connectors are rated for 1000 mating cycles and have an Insertion Loss of 0.25 dB. SC connector has a square snap-in connector latches with a simple push-pull motion and is keyed.

SC fiber patch cords can be applied in High-density connections, fiber extenders, Gigabit Ethernet, 10 Gigabit Ethernet, Active device termination, Military industry, Telecommunication networks, MAN, WAN and for Testing solutions.

Simplex: has a single fiber, and is used in applications that only require one-way data transfer.



Multi-Mode: has a large diameter (50 or 62.5 micron) core, allowing multiple lightwaves to be transmitted.

### FEATURES

- 10-Gigabit application support
- Features a Laser-Optimized 50- $\mu\text{m}$  core and 125- $\mu\text{m}$  cladding
- Use with both LED and VCSEL laser light sources
- Ceramic ferrules for long-lasting reliability and precision alignment
- Used to connect patch panels and/or network devices that require 50/125 multimode cabling
- OFNR jacket complies with stringent building codes
- Pre-terminated solution helps labor for a better financial installed solution cost

## 2.1 PACKAGE CONTENTS

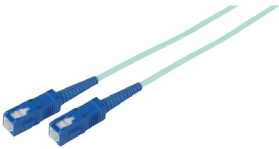
Before you start the installation of the fiber patch cable, please check the package contents.

1	FO-MMS-SC-SC-XX	X 1	
2	SPEC SHEET	X 1	



### 3. FIBER DESCRIPTION

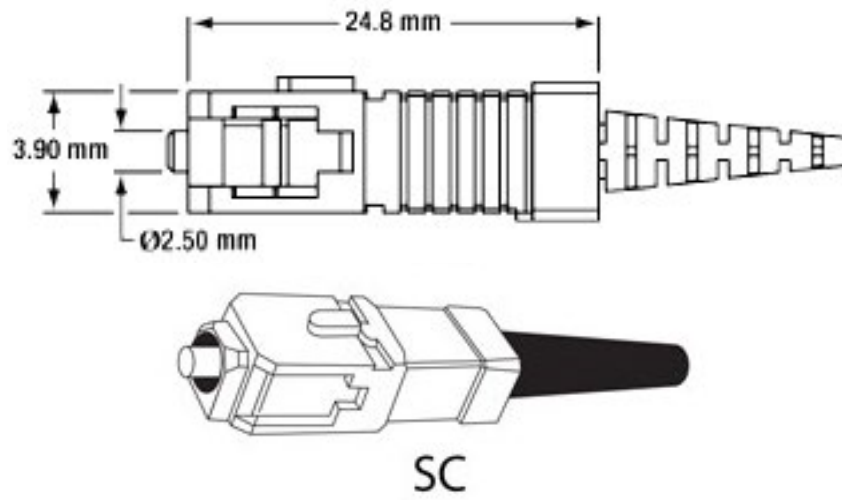

Example : Using Avenview FO-DVI-I000M-EMIX

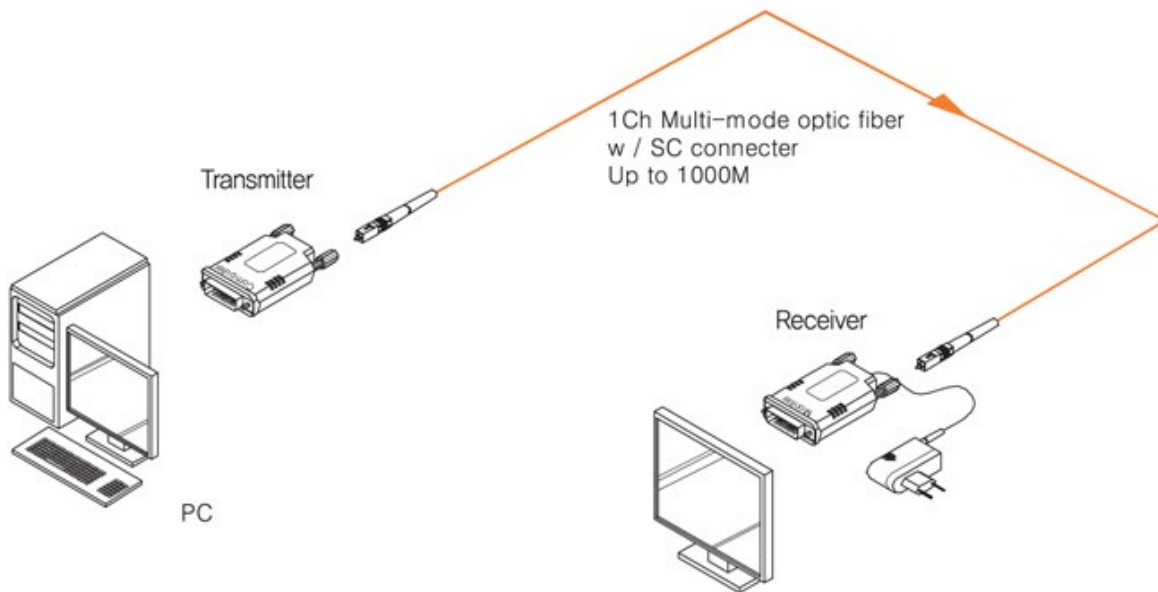

#### Multimode Fiber

Multimode fibers with fiber a core diameter of 50 microns.

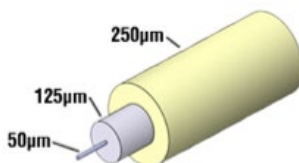
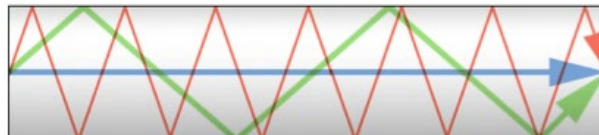

## 4. INSTALLATION

Before you proceed, please ensure the specifications and design of your fiber cabling solution. The patch cords to be installed must match with the installed wall cabling.

- **NOTE:** *Optical fiber cords of different types and specifications should not be mixed. Please note the color-coding of connectors for different fiber specs to make it easy to avoid confusion.*

1. Try not to mix cords of different core diameters. Patch cords must be of the same or higher bandwidth as the pre installed wall cabling. System performance regarding distances cannot be guaranteed if lower rated patch cords are used.
2. Kinks, snags, pinches and poor contacts can significantly reduce the performance of a fiber patch cord.
3. The minimum bend radius for optical fiber patch cords varies with cord diameter. For 3.0 mm cords the minimum un-loaded bend radius is 1.4 in (3.5 cm). Exceeding the bend radius can result in significant additional loss and adverse impact on channel performance.
4. Try not to use excessive force during the patching process. This can stress the cords and connectors, resulting in reducing their performance.
5. Bundling and tying patch cords gives the panel a neat appearance but tight bundling increases the risk of pinching.
6. Do not tighten ties beyond the point where individual cords can rotate freely. Use only specially designed products manufactured for this purpose. This is the only way to ensure there are no tangles, kinks or strains.
7. Please remember to label the cords. These will identify pair modularity and tell technicians where the other end of the cable is terminated. TIA-606-B requires that labels are visible and durable. They must be easily read by anyone carrying out work on the panel.

### REMOVING A PATCH CORD

- Locate the existing circuit on both fields of the equipment room (ER)
- Unplug the patch cord and cover the male connector with a dust cap
- Cover the open female port with a dust cover - some adapter ports have spring-loaded covers that automatically cover the port
- Gently lift the cord vertically, taking up slack until the remaining fiber cord is detected
- Gently removing it from the cable pathways or however it was secured in that position.

### ADDING A PATCH CORD

- Identify the location where the cord has to be installed
- Insert one end of the patch cord into the fiber coupling
- Labeling Fiber Optic Connecting Hardware and Cords should conform to TIA-606-B Cabling system administration, labeling and records are also covered in ISO/IEC 14763-1
- Properly route the patch cord and secure the cable with the specified products for fiber.
- Plug the other end of the patch cord into the fiber coupling to begin the transmission of data.





## 5. SPECIFICATIONS

Item	Description
<b>UNIT</b>	FO-MMS-SC-SC-XX
<b>UNIT DESCRIPTION</b>	50/125µm Fiber Optic Patch Multimode Simplex SC to SC 10Gb OM3 Aqua -XX (XXft)
<b>CLAD DIAMETER</b>	125um
<b>CORE DIAMETER</b>	50um
<b>FIBER TYPE</b>	50/125-OM3
<b>NO. OF FIBERS</b>	2
<b>APPLICATION</b>	Transportation of data over 10 Gigabit Fiber network/Duplex Fiber Extenders
<b>CABLE TYPE</b>	10Gigabit AQUA Multimode 50/125 fiber optic
<b>CABLE LENGHT</b>	3M,5,10,15,20,25,30,40,50,75-100M
<b>COLOR</b>	Aqua
<b>STYLE</b>	FIBER OPTIC
<b>LASER LIGHT</b>	LED and VCSEL
<b>CONNECTORS</b>	SC Connector Male 2.5 mm ferrule
<b>NO OF CONNECTORS</b>	4



### OPTICAL FIBER HAZARD

- Persons installing fiber optic products must take all necessary safety precautions, such as wearing protective clothing and goggles and observing warning signs.
- To ensure that the required personnel and equipment is properly installed, secure from unnecessary failure of the components or failure of the whole system, injury to one's self and in addition to legal responsibility; everyone is responsible for his own health
- Keep exposed optical fiber ends away from skin and eyes.
- The waste fragments should be treated with care and not picked up with bare hands, but rather with special gloves.
- Dispose of waste in a suitable container via an approved agency. Make sure that the quantity of optical fiber waste is minimized.
- Closures containing termination points for optical fiber cabling must be labeled with appropriate warning signs or clearly visible text.
- Make sure that the quantity of optical fiber waste is minimized. Closures containing termination points for optical fiber cabling must be labeled with appropriate warning signs or a clearly viewable text.
- There are four Laser Classifications based on risk levels. Laser manufacturers are required to label their lasers accordingly.



## Avenview Warranty Certificate

AVENVIEW CORP. ("Avenview") warrants Avenview-branded product(s) contained in the original packaging against defects in materials and workmanship when used normally in accordance with Avenview's enclosed manual guidelines for a period of THREE (3) YEARS from the date of original retail purchase - Warranty Period. Avenview's published guidelines include but are not limited to information contained in technical specifications, user manuals and service communications.

**LABOR:** During the Warranty Period of THREE (3) YEARS, Avenview will repair or replace the product(s) at no cost using new or used parts equivalent to novel performance and reliability if the product(s) is determined to have abide by Avenview's published guidelines. Cost of Labor applicable to product(s) after Warranty Period. For labor costs, please contact [support@avenview.com](mailto:support@avenview.com).

**PARTS:** During the Warranty Period of THREE (3) YEARS, Avenview will supply new or rebuilt replacements in exchange for defective parts of the product(s) at no cost if the product(s) is determined to have abide by Avenview's published guidelines. Cost of Parts applicable to product(s) after Warranty Period. For part(s) costs, please contact [support@avenview.com](mailto:support@avenview.com).

To obtain Warranty: (a) proof of purchase in the form of a bill of sale or receipted invoice reflecting that the registered product(s) is within warranty period must be presented to obtain warranty service; (b) product(s) must be registered at time of purchase. Failure to do so will result in applicable parts and labor charges. Returning product(s) must be shipped in Avenview's original packaging or in packaging pertaining equal degree of protection to Avenview's. Both Avenview and purchaser are responsible for freight charges and brokerages when shipping the product(s) to the receiver.

### NOT COVERED BY THIS WARRANTY

This warranty does not apply to any non-Avenview branded product(s); non-registered Avenview product(s). This warranty does not apply: (a) to cosmetic damage, including but not limited to scratches, dents and broken cords; (b) to damage caused by use with another product; (c) to damage caused by accident, abuse, misuse, liquid contact, fire, earthquake or other external cause; (d) to damage caused by operating the Avenview product(s) outside Avenview's manuals or guidelines; (e) to damage caused by service performed by anyone who is not a representative of Avenview or an Avenview authorized personnel; (f) to defects caused by normal wear and tear or otherwise due to the normal aging of the Avenview product(s), or (g) if any serial number has been removed or defaced from the Avenview product(s).

AVENVIEW IS NOT LIABLE FOR DIRECT, SPECIAL, INCIDENTAL OR CONSEQUENTIAL DAMAGES RESULTING FROM ANY BREACH OF WARRANTY OR CONDITION, OR UNDER ANY OTHER LEGAL THEORY, INCLUDING BUT NOT LIMITED TO LOSS OF USE; LOSS OF REVENUE; LOSS OF ACTUAL OR ANTICIPATED PROFITS (INCLUDING LOSS OF PROFITS ON CONTRACTS); LOSS OF THE USE OF MONEY; LOSS OF ANTICIPATED SAVINGS; LOSS OF BUSINESS; LOSS OF OPPORTUNITY; LOSS OF GOODWILL; LOSS OF REPUTATION; LOSS OF, DAMAGE TO, COMPROMISE OR CORRUPTION OF DATA; OR ANY INDIRECT OR CONSEQUENTIAL LOSS OR DAMAGE REPAIR OR REPLACEMENT AS PROVIDED UNDER THIS WARRANTY IS THE EXCLUSIVE REMEDY OF THE CONSUMER.

Some states do not allow the inclusion or limitation of incidental or consequential damages, or allow limitations on duration implements of the Warranty Period; therefore the above limitations or exclusions may not be applicable to you. This warranty gives you specific legal rights, and you may have other rights which vary from state to state.



275 Woodward Avenue, Kenmore, NY 14217  
1.866.508.0269



## NOTES





AV Connectivity, Distribution And Beyond...

## TECHNICAL SUPPORT

### CONTACT US



Phone: 1 (866) 508 0269



Email: [support@avenview.com](mailto:support@avenview.com)



**USA Head Office** Avenview Corp. 275 Woodward Avenue Kenmore, NY 14217

#### **USA Head Office**

Office Avenview  
Corp. 275 Woodward Avenue  
Kenmore, NY 14217  
Phone: +1.716.218.4100 ext223  
Fax: +1.866.387-8764  
Email: [info@avenview.com](mailto:info@avenview.com)

#### **Canada Sales**

Avenview  
151 Esna Park Drive, Unit 11 & 12  
Markham, Ontario, L3R 3B1  
Phone: 1.905.907.0525  
Fax: 1.866.387.8764  
Email: [info@avenview.com](mailto:info@avenview.com)

#### **Avenview Europe**

Avenview Europe  
Demkaweg 11  
3555 HW Utrecht  
Netherlands  
Phone: +31 (0)85 2100- 613  
Email: [info@avenview.eu](mailto:info@avenview.eu)

#### **Avenview Hong Kong**

Unit 8, 6/F, Kwai Cheong Centre,  
50 Kwai Cheong Road,  
Kwai Chung, N.T.  
Hong Kong  
Phone: 852-3575 9585  
Email: [wenxi@avenview.com](mailto:wenxi@avenview.com)

#### **Disclaimer**

While every precaution has been taken in the preparation of this document, Avenview Inc. assumes no liability with respect to the operation or use of Avenview hardware, software or other products and documentation described herein, for any act or omission of Avenview concerning such products or this documentation, for any interruption of service, loss or interruption of business, loss of anticipatory profits, or for punitive, incidental or consequential damages in connection with the furnishing, performance, or use of the Avenview hardware, software, or other products and documentation provided herein.

Avenview Inc. reserves the right to make changes without further notice to a product or system described herein to improve reliability, function or design. With respect to Avenview products which this document relates, Avenview disclaims all express or implied warranties regarding such products, including but not limited to, the implied warranties of merchantability, fitness for a particular purpose, and non-infringement.