

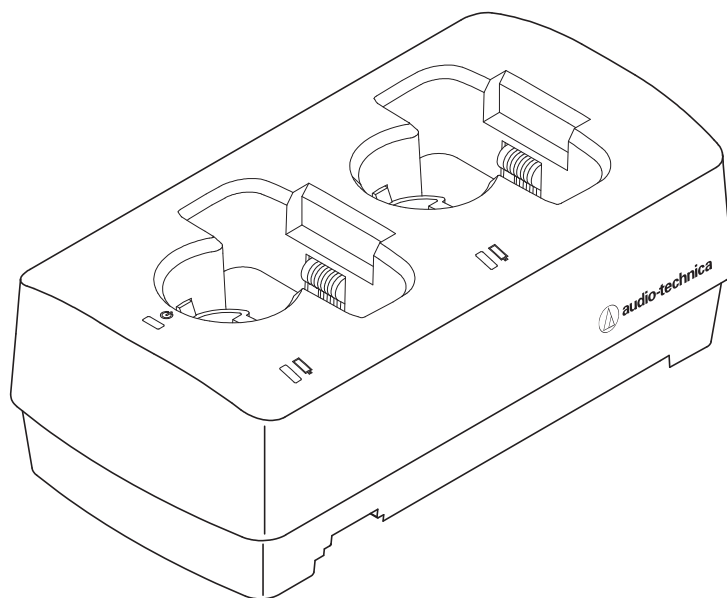

# ATW-CHG3 / ATW-CHG3N

## User Manual TWO-BAY CHARGING STATION



## Introduction

Thank you for purchasing this Audio-Technica product.

Before using the product, read through this user manual to ensure that you will use the product correctly. Please keep this manual for future reference.

## Supported models

This product supports the following models. \*

- 3000 Digital Series (ATW-DT3101, ATW-DT3102)
- 3000 Series (ATW-T3201, ATW-T3202)

\*There are differences in the handled products depending on the country where they are sold.

## Recommended batteries

The following batteries can be charged with this product.

Name	Manufacturer	Capacity
eneloop	Panasonic	1900 mAh
eneloop pro	Panasonic	2500 mAh
Duracell Rechargeable	Duracell	1950 mAh
Energizer	Energizer	2300 mAh
Ansmann	Ansmann	2850 mAh
VARTA	VARTA	2100 mAh
GP ReCyko+ 2700 Series	GP Batteries	2600 mAh

- All other company and product names that appear in this document are trademarks or registered trademarks of their respective owners.

## Important information

### Warning:

- To prevent fire or shock hazard, do not expose this apparatus to rain or moisture.

### Caution:

- Do not expose this apparatus to drips or splashes.
- To avoid electric shock, do not open the cabinet.
- Refer servicing to qualified personnel only.
- Do not expose this apparatus to excessive heat such as that generated by sunshine, fire or other heat sources.
- Do not subject this apparatus to strong impact.
- This apparatus should be located close enough to the AC outlet so that you can easily grasp the AC adapter at any time.
- In case of emergency, disconnect the AC adapter quickly.
- Do not place any objects filled with liquids, such as vases, on this apparatus.
- To prevent fire, do not place any naked flame sources (such as lighted candles) on this apparatus.
- Do not install this apparatus in a confined space such as a bookcase or similar unit.
- Install this apparatus only in the places with good ventilation.
- The rating label is put on the bottom of this apparatus.

### Battery caution:

- Do not expose the battery to excessive heat such as sunshine, fire or the like.
- Always consider the environment issues and follow local regulations when disposing of batteries.

### For customers in the USA

#### FCC Notice

#### Warning:

This device complies with Part 15 of the FCC Rules. Operation is subject to the following two conditions: (1) This device may not cause harmful interference, and (2) this device must accept any interference received, including interference that may cause undesired operation.

#### Caution:

You are cautioned that any changes or modifications not expressly approved in this manual could void your authority to operate this equipment.

**Note:** This equipment has been tested and found to comply with the limits for a Class B digital device, pursuant to part 15 of the FCC Rules. These limits are designed to provide reasonable protection against harmful interference in a residential installation. This equipment generates, uses and can radiate radio frequency energy and, if not installed and used in accordance with the instructions, may cause harmful interference to radio communications. However, there is no guarantee that interference will not occur in a particular installation. If this equipment does cause harmful interference to radio or television reception, which can be determined by turning the equipment off and on, the user is encouraged to try to correct the interference by one or more of the following measures:

- Reorient or relocate the receiving antenna.
- Increase the separation between the equipment and receiver.
- Connect the equipment into an outlet on a circuit different from that to which the receiver is connected.
- Consult the dealer or an experienced radio/TV technician for help.

### For customers in Canada

#### IC statement

CAN ICES-3(B)/NMB-3(B)

---

## Notes on use

---

- Be sure to read the user manual for any device that you attach to the product.
- Disconnect the AC adapter from the outlet when this product is not in use.
- Be sure to use this product in combination with components specified by our company.
- When connecting cables, make sure they are inserted all the way up to the plug.
- Over time, discoloration may occur due to ultraviolet rays (especially direct sunlight) and friction.
- Charge on flat areas. Devices will not be charged when the product is tilted.
- If you repeatedly charge rechargeable batteries without completely exhausting them, a phenomenon called the memory effect occurs, where the power capacity of the batteries is reduced. To prevent this, completely exhaust rechargeable batteries before charging them. If you continue to have problems recharging the batteries, you may need to replace them with new rechargeable batteries.
- When using the product as a stand without charging, unplug the AC adapter.
- Heat is generated from the AC adapter while charging. Do not place the product near the AC adapter or in places of high temperature. Rechargeable batteries may not fully charge.
- The capacity of the rechargeable batteries decreases as you repeatedly charge them. If the operation time becomes shorter, we recommend replacing the batteries with new ones as soon as possible.
- If the product or the charging terminals of charging devices are dirty, the devices may not be able to charge sufficiently. Remove the dirt from the charging terminals before inserting devices into the product.
- When charging for the first time or when not using the product for long periods, the power capacity of rechargeable batteries may decrease. In such cases, the batteries will recharge normally (to full capacity) after they have been charged and discharged several times.
- Charge rechargeable batteries every six months even if you have not used them much during that time. Excessive discharging may decrease the capacity of rechargeable batteries or cause them to no longer be rechargeable.

---

## Maintenance

---

- If the product becomes stained or covered with dust, be sure to disconnect the power plug before wiping it off with a dry and soft cloth.
- Do not use benzine, thinner or electrical contact cleaner, etc. They may deform or otherwise damage the product, or cause operational failure.

## Part names and functions

### ATW-CHG3

Top

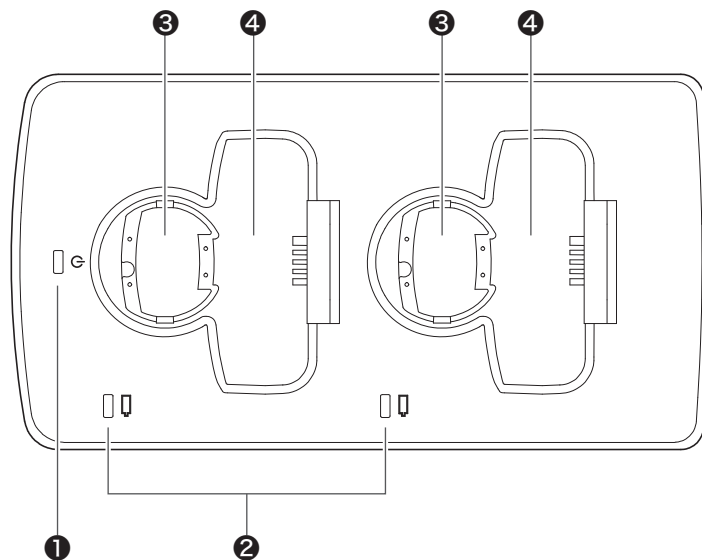

- ❶ Power indicator  
Lights up when the AC adapter is connected and the power is on.
- ❷ Status indicator  
Shows the charging status.
- ❸ Charging port (for handheld transmitters)
- ❹ Charging port (for body-pack transmitters)

## Part names and functions

### ATW-CHG3

#### Bottom

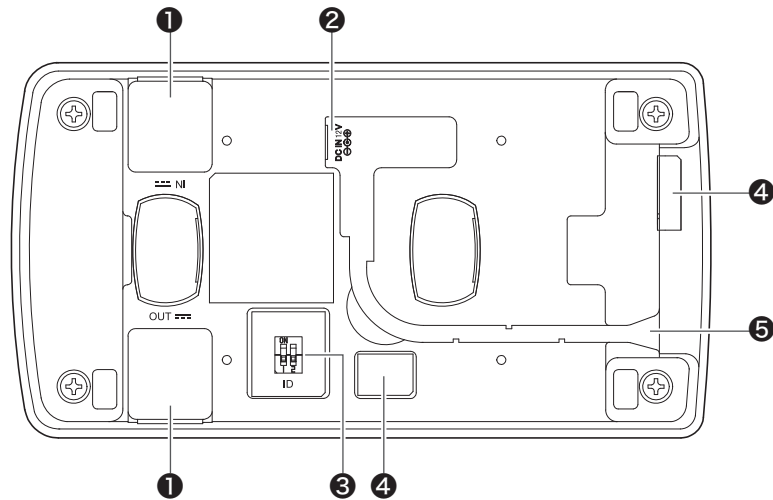

- 1** Cap for DC jack  
Removed when linking multiple units of this product (see below).
- 2** DC input jack  
Connects the AC adapter.
- 3** ID selector switch  
Used for switching when linking multiple units and configuring network settings.
- 4** Blind seal
- 5** Cord outlet  
Passes the AC adapter cord.

#### Bottom (caps for DC jacks removed)

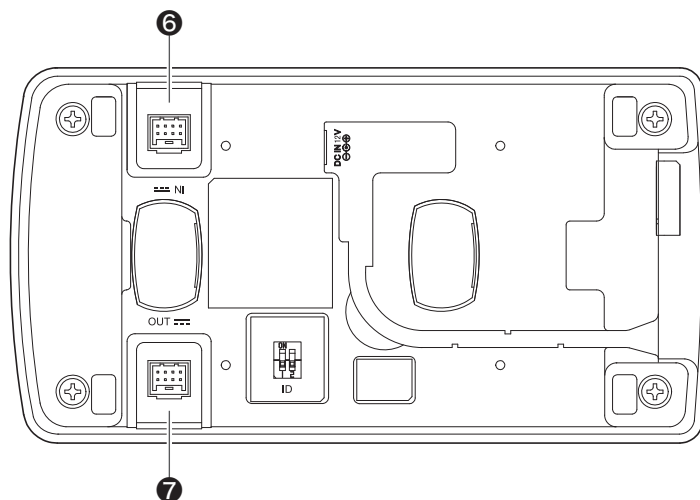

- 6** DC input jack for linking  
Used when linking multiple units of this product. Power is supplied from linked products.
- 7** DC output jack for linking  
Used when linking multiple units of this product. Supplies power to linked products.

## Part names and functions

### ATW-CHG3N

Top

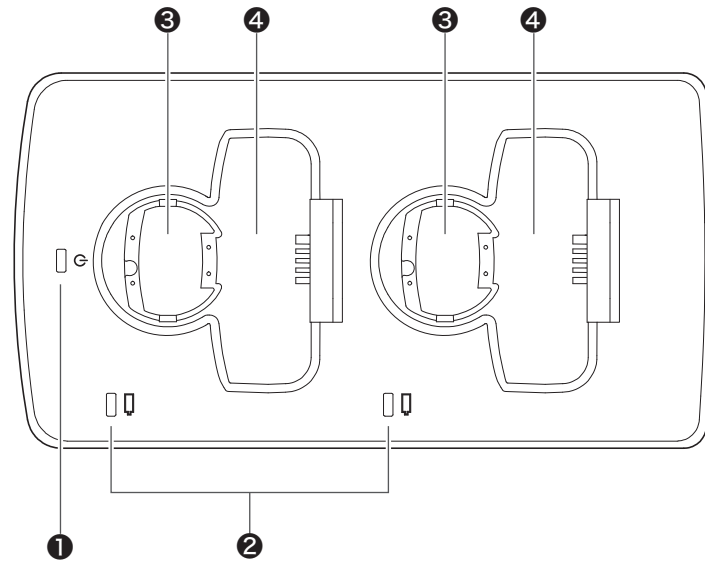

- ❶ Power indicator  
Lights up when the AC adapter is connected and the power is on.
- ❷ Status indicator  
Shows the charging status.
- ❸ Charging port (for handheld transmitters)
- ❹ Charging port (for body-pack transmitters)

## Part names and functions

### ATW-CHG3N

#### Bottom

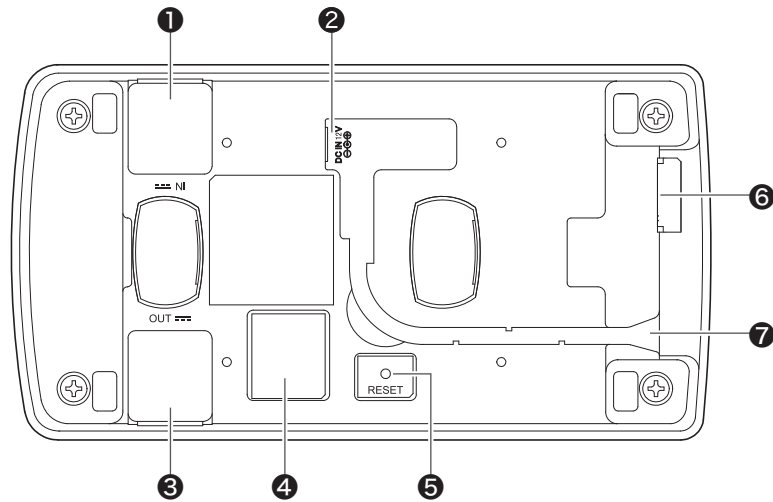

- 1** Blind cap
- 2** DC input jack  
Connects the AC adapter.
- 3** Cap for DC jack  
Removed when linking multiple ATW-CHG3 units (see below).
- 4** Blind seal
- 5** Reset button  
Resets network settings.
- 6** Network port  
Used when connecting a network cable (Type: RJ45) to use the dedicated app on a Windows computer/Mac.
- 7** Cord outlet  
Passes the AC adapter cord.

#### Bottom (caps for DC jacks removed)

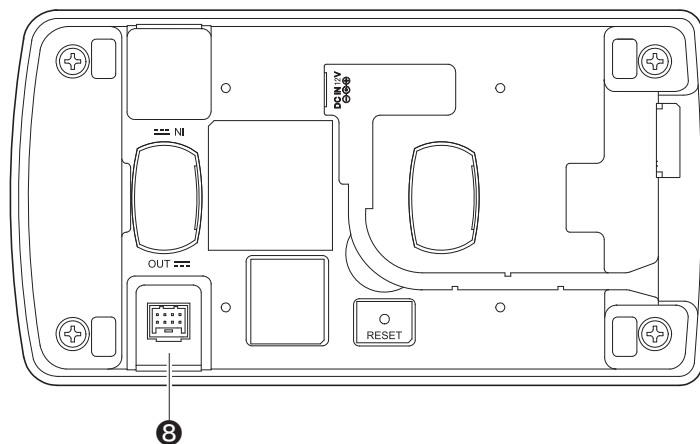

- 8** DC output jack for linking  
Used when linking multiple ATW-CHG3 units. Supplies power to linked products.

## Using the product

### 1. Connect the AC adapter.

- Pass the cord along the groove on the product and bring it out from the cord outlet.

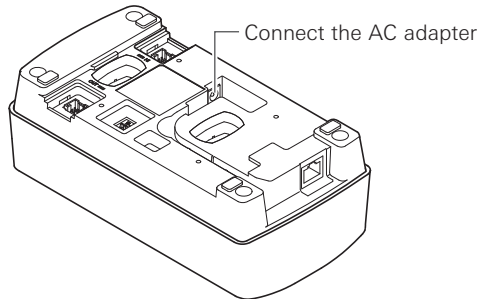

### 2. The power indicator lights up and the power turns on.

### 3. Turn off the device that will be charged and insert it into a charging port on the product.

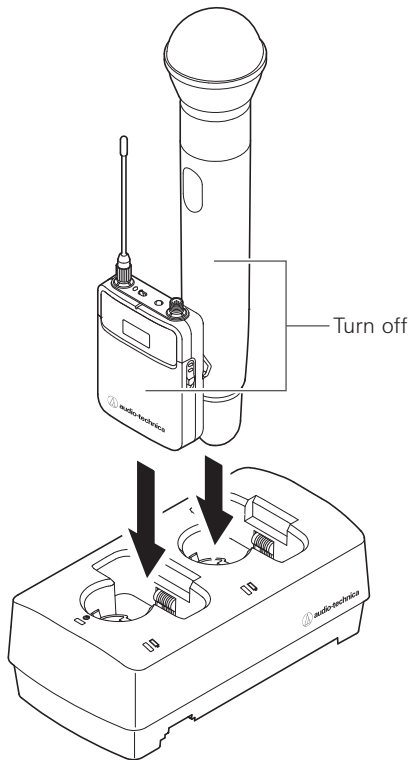

### 4. The status indicator lights up and the charging status is displayed.

- For more about indicators' lighting sequences, refer to "Indicators" (p.9).
- Charging completes in about 6.5 hours (when using 1900 mAh rechargeable batteries).

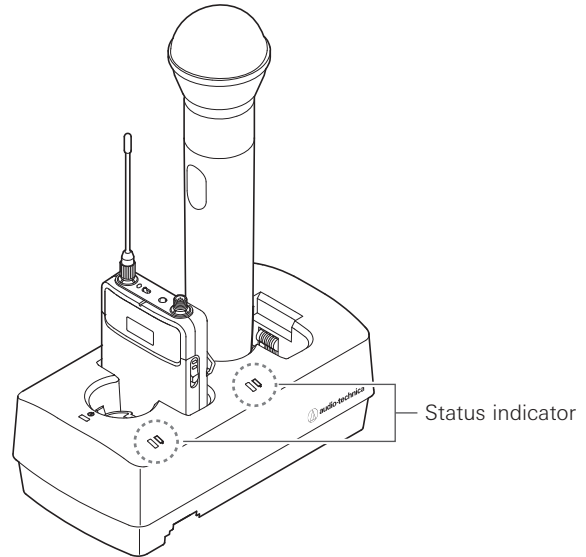

- Use devices after they are fully charged.
- If a transmitter with fully charged batteries is placed in the charger, the red light will remain on for a minimum of 3 hours, even though the batteries are fully charged.
- If you insert a device and the status indicator flashes, there may be a charging defect.
- Non-rechargeable batteries cannot be charged. If non-rechargeable batteries are inserted, a charging defect may be displayed.
- If a charging defect occurs, unplug the AC adapter to turn off the product, and then restart it. If the indicator still flashes even after restarting the product, the rechargeable batteries may no longer have any life. Replace them with new rechargeable batteries.

- You can charge up to two devices at the same time.
- Check the orientation of the device that will be charged before inserting it. It cannot charge if the orientation is incorrect.
- When charging a handheld transmitter, attach the microphone capsule.
- Although we recommend that you charge a device while it is off, you can also charge while it is on. In such cases, the device will turn off automatically.



# Connections

## Example system configuration

Connect while referring to the figure below.

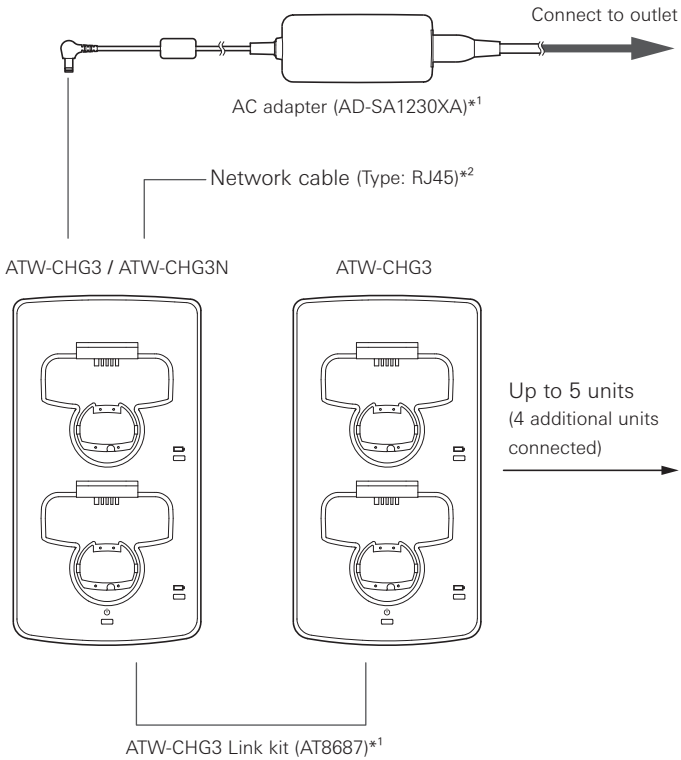

### Contents

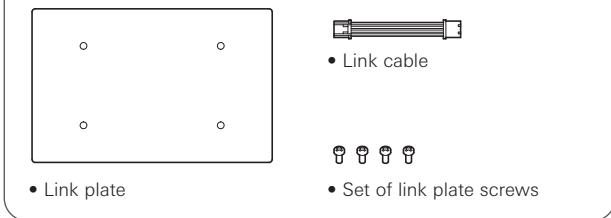

\*1 Sold separately.

\*2 Used when connecting to a network. Only ATW-CHG3N can be connected.

## Linking (when using multiple units)

1. Remove the caps for DC jacks.
2. Connect the AC adapter to the first unit, and connect the link cable to the DC output jack for linking. Next, connect the link cable to the DC input jack for linking on the second unit.
  - Connecting an AC adapter to the second unit or any unit thereafter is not necessary.
  - You can add up to four ATW-CHG3 units, for a total of 5 connected units.

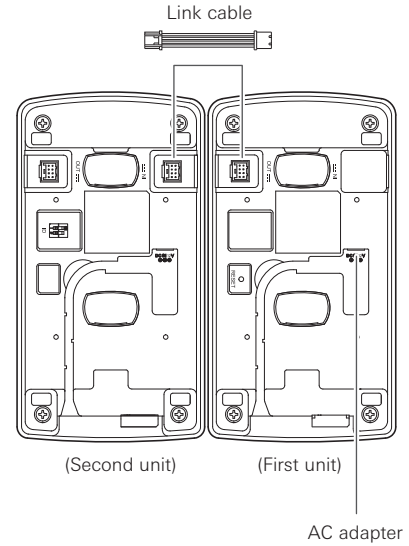

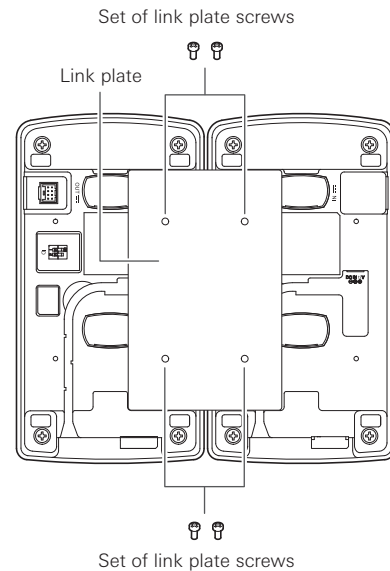

3. Fasten the link plate with link plate screws.





# Indicators

The indicators of the product flash and shine continuously to indicate the following operation statuses.

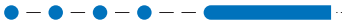
## Power indicator

Operation status		Indicator display pattern ● Blue	
Network cable connected		Blue changes to green.	
Power on			Lights solid blue
Mode confirmation	Auto (automatic IP address acquisition)		Flashes twice, then changes to the indicator display for power on.
	Static (fixed IP address)		Flashes three times, then changes to the indicator display for power on.
Resetting			Flashes for about two seconds, then changes to the indicator display for power on.

## Status indicator

Operation status		Indicator display pattern ● Red ● Green	
Charging			Lights solid red
Charging complete			Lights solid green
Charging defect			Flashing red





# Network settings

You can use the Charger IP Tool dedicated application or the Wireless Manager software to monitor and control the status of ATW-CHG3N and linked chargers via Windows PC or Mac.

## Setting the ID (ATW-CHG3N)

When linking chargers, you can use the dedicated application Charger IP Tool or the Wireless Manager software to monitor and control all of them by setting different IDs for each charger.

- The default setting is "2".
  - The ID of ATW-CHG3N is fixed at "1".
  - If ATW-CHG3N is not linked, setting the ID is not necessary.
1. Refer to the table below and set the ID selector switch while the product is off.

Switch position	ID number	Switch position	ID number
	2		4
	3		5

2. Connect the AC adapter and turn on the product.
  - The setting is complete.
  - If you set the ID while the product is on, turn it off and then turn it on again.

## Confirming the mode (ATW-CHG3N)

You can confirm whether the mode is set to "Auto" or "Static".

- "Auto" is a mode in which the IP address is acquired automatically, while in "Static", the IP address is fixed.
  - The dedicated application (Charger IP Tool or Wireless Manager) is used to change the mode.
  - The default setting is "Auto".
1. Quickly press the reset button.
  2. The power indicator flashes twice for Auto or three times for Static, and then shines continuously.
    - For more about indicators' lighting sequences, refer to "Indicators" (p.9).

## Resetting (ATW-CHG3N)

You can return the network settings to their factory defaults.

1. Press and hold (about 2 seconds) the reset button.
2. The power indicator flashes for about two seconds, and then shines continuously.
  - Resetting is complete.
  - For more about indicators' lighting sequences, refer to "Indicators" (p.9).

# Charger IP Tool

## Charger IP Tool

Charger IP Tool is a dedicated application for configuring the network settings of ATW-CHG3N. You can configure the following settings from a Windows computer.

- Device ID of ATW-CHG3N
- Mode of ATW-CHG3N (Auto/Static)
- IP address, subnet mask, and gateway address of ATW-CHG3N only when in (Static mode)

## Recommended environment

Microsoft Windows 7 or later

## Preparations

### Connecting ATW-CHG3N and a Windows computer

1. Before connecting ATW-CHG3N and a Windows computer, configure the settings related to the network of the Windows computer based on the network mode settings of ATW-CHG3N.
  - If ATW-CHG3N is set to "Auto" or "Static", set the IP address to be acquired automatically or fixed respectively.
  - The default setting is "Auto".
2. Make a wired connection between ATW-CHG3N and the Windows computer.
3. Turn on ATW-CHG3N and the Windows computer.

## Setting up Charger IP Tool

1. Download the Charger IP Tool installer/app onto the Windows computer.
  - Download from our company homepage ([www.audio-technica.com](http://www.audio-technica.com)) for your country or region.
2. Double-click the downloaded "setup.exe".
  - The setup wizard is displayed.
3. Follow the instructions displayed on the screen to install Charger IP Tool.
4. Double-click the Charger IP Tool icon.
  - Charger IP Tool starts. ATW-CHG3N connected to the network is detected automatically.

- If the device to be updated is not recognized, confirm the IP settings of the Windows computer connected to the device.
- This application may not start depending on the firewall settings of your computer and security software. In such cases, confirm the firewall settings and allow communication with this application. For details about how to use your Windows computer and security software, refer to the user manuals of your products.
- A confirmation screen asking to allow communication during setup may be displayed depending on the operating system and security software. In such cases, allow communication.

# Using Charger IP Tool

## Charger IP Tool screen

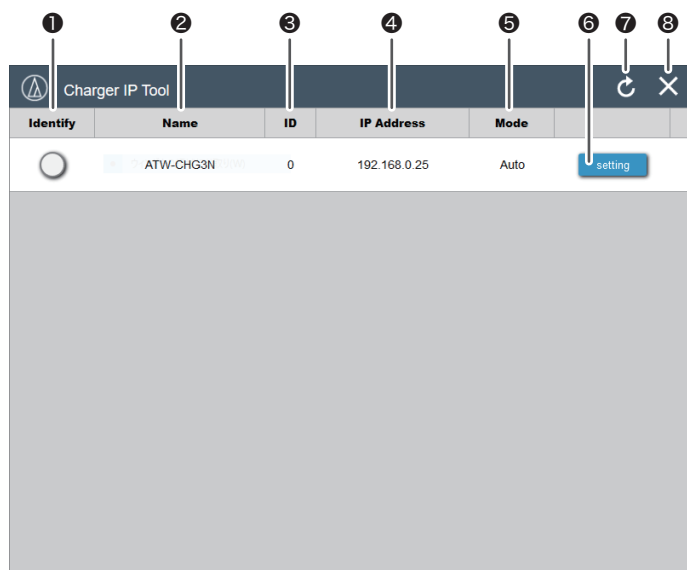

- 1 Identify**  
The icon flashes red and the power indicator of the corresponding ATW-CHG3N flashes when the icon is clicked.
- 2 Name**  
Displays the name of each device. Click [Name] to sort the list in alphabetical order.
- 3 ID**  
Displays the ID of each device. Click [ID] to sort the list in numerical order.
- 4 IP Address**  
Displays the IP address of each device. Click [IP Address] to sort the list in numerical order.
- 5 Mode**  
Displays the mode (Auto/Static) of the connected device.
- 6 Setting**  
Opens the setting screen of the selected ATW-CHG3N when clicked.
- 7 Refresh**  
Refreshes the device list when clicked.
- 8 Close**  
Closes the application when clicked.

## Setting screen

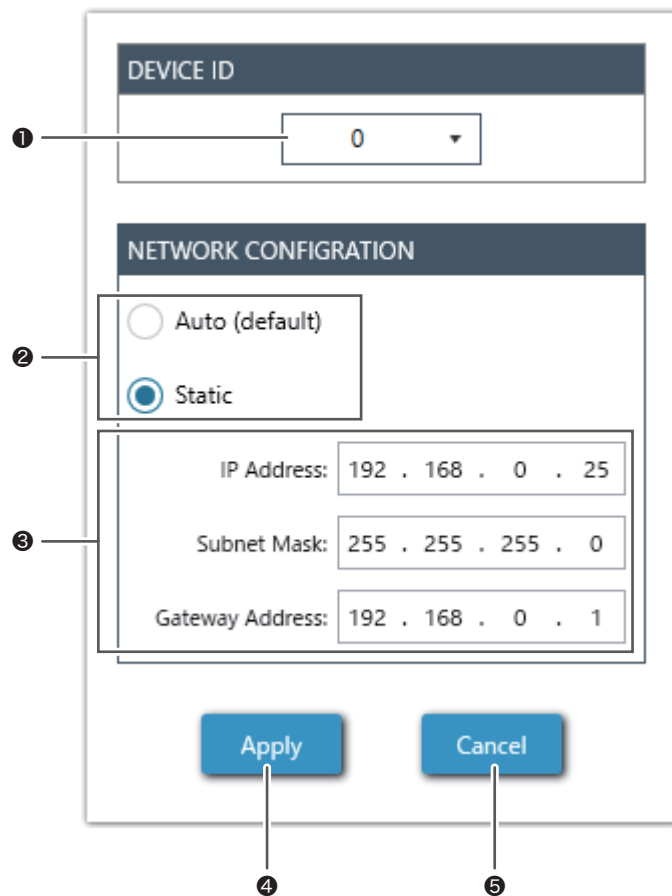

- 1 Device ID**  
You can set a number from 0 to 255 for the ID.
- 2 Mode Select**  
You can select Auto or Static for the mode.
- 3 Network Properties**  
If Static is selected, you can set the IP address, subnet mask, and gateway address.
- 4 Apply**  
Applies the settings. When you apply settings, the power indicator of the corresponding ATW-CHG3N changes from flashing green and blue to solid green.
- 5 Cancel**  
Cancels setting changes and closes the screen.

## Troubleshooting

Issue	Cause/Solution	Reference
The product does not turn on.	Check if the AC adapter is connected properly.	-
The device does not charge.	Check if the charging terminals are dirty.	-
	Check if batteries are inserted in the device or if the batteries are alkaline batteries.	-
	Check if there is a charging defect.	p.7

## Dimensions

(Units: mm)

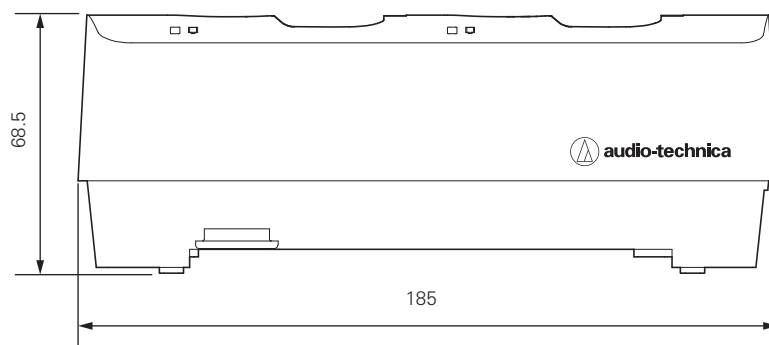
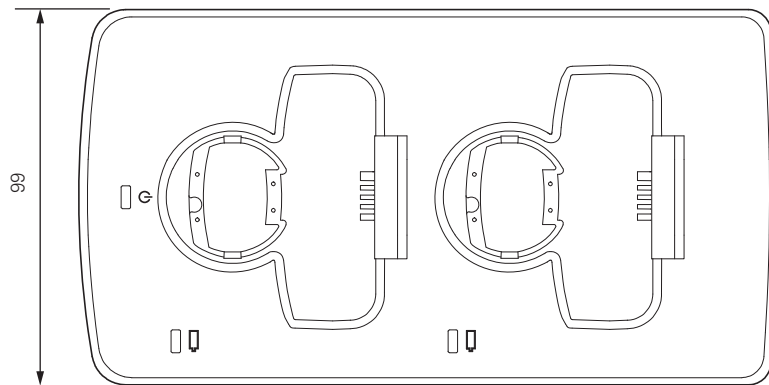

## Specifications

Power supply	DC12V 3.0A
Charging output	DC3.6V 500mA×2
Power consumption	4.9W (CHG3) (when 2 transmitters are charging) 5.3W (CHG3N) (when 2 transmitters are charging) 27.4W (CHG3×5) (5 units are connected and 10 transmitters are charging) 27.8W (CHG3N×1) (CHG3×4) (5 units are connected and 10 transmitters are charging)
Charging time	Approx. 6.5 hours (1,900 mAh rechargeable battery)*
Operating temperature	0 °C to 40 °C (32 °F to 104 °F)
Dimensions	185 mm (7.28") × 99 mm (3.90") × 68.5 mm (2.70") (W × D × H)
Weight	400 g (14.1 oz) (ATW-CHG3) 410 g (14.5 oz) (ATW-CHG3N)
Sold separately	AC adapter (AD-SA1230XA), ATW-CHG3 Link kit (AT8687)

\*The time may vary depending on usage conditions.

**Audio-Technica Corporation**

2-46-1 Nishi-naruse, Machida, Tokyo 194-8666, Japan

©2019 Audio-Technica Corporation

Global Support Contact: [www.at-globalsupport.com](http://www.at-globalsupport.com)

232900910-02-02 ver.1 2018.09.01  
ver.2 2019.04.01