



KX Series & CCKM

KVM over IP Extender and
KVM over IP Matrix Manager
User Manual

Compliance Statements

FEDERAL COMMUNICATIONS COMMISSION INTERFERENCE STATEMENT

This equipment has been tested and found to comply with the limits for a Class A digital device, pursuant to Part 15 of the FCC Rules. These limits are designed to provide reasonable protection against harmful interference when the equipment is operated in a commercial environment. This equipment generates, uses, and can radiate radio frequency energy and, if not installed and used in accordance with the instruction manual, may cause harmful interference to radio communications. Operation of this equipment in a residential area is likely to cause harmful interference in which case the user will be required to correct the interference at his own expense.

The device complies with Part 15 of the FCC Rules. Operation is subject to the following two conditions: (1) this device may not cause harmful interference, and (2) this device must accept any interference received, including interference that may cause undesired operation.

FCC Caution

Any changes or modifications not expressly approved by the party responsible for compliance could void the user's authority to operate this equipment.

Warning

Operation of this equipment in a residential environment could cause radio interference.

Achtung

Der Gebrauch dieses Geräts in Wohnumgebung kann Funkstörungen verursachen.



KCC Statement

유선 제품용 / A 급 기기 (업무용 방송 통신 기기)
이 기기는 업무용 (A 급) 전자파적합기기로서 판매자 또는 사용자는 이
점을 주의하시기 바라며, 가정 외의 지역에서 사용하는 것을 목적으로
합니다.

Industry Canada Statement

This Class A digital apparatus complies with Canadian ICES-003.

CAN ICES-003 (A) / NMB-003 (A)

RoHS

This product is RoHS compliant.

User Information

Online Registration

Be sure to register your product at our online support center:

| | |
|---------------|---|
| International | http://eservice.aten.com |
|---------------|---|

Telephone Support

For telephone support, call this number:

| | |
|---------------|---|
| International | 886-2-8692-6959 |
| China | 86-400-810-0-810 |
| Japan | 81-3-5615-5811 |
| Korea | 82-2-467-6789 |
| North America | 1-888-999-ATEN ext 4988 1-949-428-1111 |

User Notice

All information, documentation, and specifications contained in this manual are subject to change without prior notification by the manufacturer. The manufacturer makes no representations or warranties, either expressed or implied, with respect to the contents hereof and specifically disclaims any warranties as to merchantability or fitness for any particular purpose. Any of the manufacturer's software described in this manual is sold or licensed *as is*. Should the programs prove defective following their purchase, the buyer (and not the manufacturer, its distributor, or its dealer), assumes the entire cost of all necessary servicing, repair and any incidental or consequential damages resulting from any defect in the software.

The manufacturer of this system is not responsible for any radio and/or TV interference caused by unauthorized modifications to this device. It is the responsibility of the user to correct such interference.

The manufacturer is not responsible for any damage incurred in the operation of this system if the correct operational voltage setting was not selected prior to operation. **PLEASE VERIFY THAT THE VOLTAGE SETTING IS CORRECT BEFORE USE.**

Product Information

For information about all ATEN products and how they can help you connect without limits, visit ATEN on the Web or contact an ATEN Authorized Reseller. Visit ATEN on the Web for a list of locations and telephone numbers:

| | |
|---------------|---|
| International | http://www.aten.com |
| North America | http://www.aten-usa.com |

Package Contents

Check to make sure that all the components are in working order. If you encounter any problem, please contact your dealer.

KX9970

- 1 KX9970T 5K DisplayPort KVM over IP Transmitter
- 1 KX9970R 5K DisplayPort KVM over IP Receiver
- 1 DisplayPort cable (KX9970T only)
- 1 USB Type-A to Type-B cable (KX9970T only)
- 1 power adapter
- 1 foot pad set (4 pcs)
- 1 user instructions

KX9970F

- 1 KX9970FT 5K DisplayPort KVM over IP Transmitter
- 1 KX9970FR 5K DisplayPort KVM over IP Receiver
- 1 DisplayPort cable (KX9970FT only)
- 1 USB Type-A to Type-B cable (KX9970FT only)
- 1 power adapter
- 1 foot pad set (4 pcs)
- 1 user instructions

Contents

| | |
|---------------------------------|------|
| Compliance Statements | ii |
| User Information | iv |
| Online Registration | iv |
| Telephone Support | iv |
| User Notice | iv |
| Product Information | v |
| Package Contents | vi |
| KX9970 | vi |
| KX9970F | vi |
| Contents | vii |
| About This Manual | xiii |
| Conventions | xv |

Chapter 1. Introduction

| | |
|--|----|
| Overview | 1 |
| Features | 3 |
| Supported Video Resolutions Requirements | 6 |
| Operating System | 7 |
| Console | 7 |
| Computers | 7 |
| Cables | 8 |
| CCKM Requirements | 8 |
| Virtual Machine | 9 |
| Components | 10 |
| KX9970T (Transmitter) Front View | 10 |
| KX9970T (Transmitter) Rear View | 10 |
| KX9970R (Receiver) Front View | 12 |
| KX9970R (Receiver) Rear View | 12 |
| KX9970FT (Transmitter) Front View | 14 |
| KX9970FT (Transmitter) Rear View | 14 |
| KX9970FR (Receiver) Front View | 16 |
| KX9970FR (Receiver) Rear View | 16 |

Chapter 2. Hardware Setup

| | |
|---|----|
| Mounting | 19 |
| Attaching the Mounting Bracket | 20 |
| Rack Mount | 21 |
| Wall Mount | 22 |
| KX9970 Point-to-Point Installation | 23 |
| KX9970 Point-to-Point Installation Diagram | 24 |
| KX9970F Point-to-Point Installation | 26 |
| KX9970F Point-to-Point Installation Diagram | 27 |
| KX9970 LAN Installation | 29 |
| KX9970 Network Installation Diagram | 30 |

| | |
|--|----|
| KX9970F LAN Installation | 31 |
| KX9970F Network Installation Diagram | 32 |
| Network Configuration | 33 |
| Exit OSD | 34 |
| Default IP Addresses | 34 |
| KX I/O Ports | 35 |
| LED Display | 36 |
| Front Panel | 36 |
| Rear Panel | 36 |

Chapter 3.OSD Operation

| | |
|-------------------------------------|----|
| Overview | 37 |
| Invoking the OSD | 37 |
| Touch Screen Calibration | 37 |
| OSD Hotkeys | 38 |
| Non-OSD Hotkeys | 38 |
| Reverting to Previous | 38 |
| Hotkey Mode | 38 |
| Microphone Hotkey | 39 |
| OSD Interface | 39 |
| Logging in for the First Time | 40 |
| Receiver Configuration | 41 |
| Network | 41 |
| Properties | 42 |
| System | 44 |
| Transmitter Configuration | 45 |
| Network | 46 |
| Properties | 47 |
| System | 50 |
| User Preferences | 51 |
| OSD Matrix Mode | 52 |
| Connections Page | 53 |
| List Mode | 53 |
| Array Mode | 56 |
| Profile Page | 58 |
| Push Content | 59 |
| Pull Content | 61 |

Chapter 4.Software Installation

| | |
|--|----|
| Overview | 63 |
| Download | 63 |
| KVM over IP Matrix Manager Install | 66 |
| Upgrading License | 70 |
| Linux Installation | 71 |

Chapter 5.Browser / Telnet Operation

| | |
|----------------|----|
| Overview | 75 |
|----------------|----|

| | |
|--|----|
| Logging In | 75 |
| The KVM over IP Matrix Manager Main Page | 77 |
| Web Components | 77 |
| Interactive Display Panel | 78 |
| Installation Wizard | 79 |
| Adding Transmitters and Receivers | 80 |
| Adding Network Switches | 83 |
| Instant Link | 85 |
| RS-232 / Telnet | 87 |
| Telnet | 87 |
| RS-232 | 88 |
| Configuration Menu | 89 |
| Main Menu | 89 |
| 1. Network | 90 |
| 2. Properties | 90 |
| 3. System | 91 |

Chapter 6. System Status

| | |
|---|-----|
| Overview | 93 |
| System Status | 94 |
| Transmitter | 96 |
| SFP+ Module and Power Detection | 97 |
| Transmitter Configuration | 98 |
| Copy & Paste | 101 |
| Virtual Transmitter | 102 |
| Transmitter Group | 104 |
| Transmitter Permissions | 105 |
| Receiver | 107 |
| SFP+ Module and Power Detection | 108 |
| Receiver Configuration | 109 |
| Copy & Paste | 112 |
| Receiver Group | 113 |
| Video Wall | 114 |
| Receiver Permissions | 117 |
| Switch | 118 |
| Network Switch Configuration | 119 |
| Port Configuration | 120 |
| Account | 121 |
| Users | 122 |
| Adding Users | 122 |
| Modifying Users | 124 |
| Deleting Users | 124 |
| Groups | 125 |
| Adding Groups | 125 |
| Modifying Groups | 126 |
| Deleting Groups | 126 |

| | |
|------------------------------------|-----|
| Permissions | 127 |
| Assigning Device Permissions | 127 |
| Profile | 129 |
| Adding a Profile | 130 |
| Adding a Schedule | 133 |
| Log | 134 |

Chapter 7. System Settings

| | |
|-----------------------------------|-----|
| Overview | 135 |
| General | 135 |
| Connection Redundancy | 141 |
| ANMS | 144 |
| Event Destination | 144 |
| Authentication | 146 |
| SNMP | 150 |
| SMTP | 151 |
| Syslog | 153 |
| FW Upgrade | 154 |
| Firmware Upgrade Recovery | 155 |
| Redundancy | 156 |
| Backup / Restore | 158 |
| Backup | 159 |
| Restore | 159 |
| Certificates | 160 |
| Private Certificate | 160 |
| Certificate Signing Request | 161 |
| Sessions | 163 |

Chapter 8. Connections

| | |
|-------------------|-----|
| Overview | 165 |
| Connections | 166 |

Chapter 9. Scheduled Profile

| | |
|----------------|-----|
| Overview | 169 |
|----------------|-----|

Chapter 10. Sessions

| | |
|----------------|-----|
| Overview | 171 |
|----------------|-----|

Chapter 11. ATEN Matrix Link

| | |
|---|-----|
| Overview | 173 |
| Requirements | 173 |
| Accessing CCKM | 173 |
| Monitoring | 175 |
| Adjusting Preview Size | 175 |
| Searching for a Device | 175 |
| Checking a Receiver's Tx-Connection | 176 |
| Connecting Tx-Rx | 177 |

| | |
|---|-----|
| Access Types | 178 |
| Logout | 178 |
| Chapter 12. Firmware Upgrade Utility | |
| Preparation | 179 |
| Starting the Upgrade | 180 |
| Upgrade Succeeded | 183 |
| Firmware Upgrade Recovery | 184 |
| Chapter 13. CLI Commands | |
| Serial Control Protocol Commands | 185 |
| Configuring the Serial Port | 185 |
| Device/Profile Commands | 186 |
| Telnet | 186 |
| Verification | 186 |
| Switch Port Command | 187 |
| Mute Command | 191 |
| Profile Command | 193 |
| EDID Command | 195 |
| Reset Command | 197 |
| RS-232 Command | 198 |
| OSD Command | 201 |
| List Command | 202 |
| Read Command | 204 |
| Set Command | 208 |
| Appendix | |
| Safety Instructions | 217 |
| General | 217 |
| Rack Mount | 219 |
| Technical Support | 220 |
| International | 220 |
| North America | 220 |
| Specifications | 221 |
| KX9970T / KX9970FT | 221 |
| KX9970R / KX9970FR | 223 |
| Optional Rack Mount | 224 |
| Dual Rack Mount | 224 |
| Transmitter Dual Rack Mount | 224 |
| Receiver Dual Rack Mount | 226 |
| Single Rack Mount | 228 |
| IP Installer | 230 |
| Trusted Certificates | 231 |
| Overview | 231 |
| Self-Signed Private Certificates | 232 |
| Examples | 232 |
| Importing the Files | 232 |

| | |
|---|-----|
| Reset All Information | 233 |
| Default Password Pins | 234 |
| RS-232 Pin Assignments | 235 |
| Transmitter Front RS-232 Port | 235 |
| Multicast IP Address | 236 |
| KX Multicast Rule | 236 |
| Multicast IP Formula | 236 |
| If X is between 0 ~ 127 | 236 |
| If X is between 128 ~ 192 | 237 |
| If X is 192 or higher | 237 |
| Keys to Network Performance | 238 |
| Build a Network Diagram | 238 |
| Other Factors | 238 |
| Choose a High Performance Switch | 240 |
| Layer 2 or Layer 3 Switches | 240 |
| Considerations | 240 |
| Number of ports | 240 |
| Stackable verse Standalone | 240 |
| What Stackable Switches Can do: | 241 |
| Switch Specifications. | 241 |
| Configuring Switches and KX Devices | 242 |
| KX transmitter Settings: | 242 |
| Recommended Network Switches | 242 |
| Additional Mouse Synchronization Procedures | 243 |
| Windows: | 243 |
| Sun / Linux | 244 |
| Virtual Media Support | 245 |
| WinClient ActiveX Viewer / WinClient AP | 245 |
| Java Applet Viewer / Java Client AP. | 245 |
| Setup CCKM Server IP address on Windows | 246 |
| Limited Warranty. | 247 |

About This Manual

This manual is provided to help you get the most out of your KVM over IP Matrix System. It covers all aspects of the device and system, including installation, configuration, and operation.

The KVM over IP Extender models covered in this user manuals are:

| Models | Product Names |
|---------|--|
| KX9970 | 5K DisplayPort KVM over IP Extender (Transmitter & Receiver) |
| KX9970F | 5K DisplayPort KVM over IP Extender (Transmitter & Receiver) |

An overview of the information found in the manual is provided below.

Chapter 1, Introduction, introduces you to the KVM over IP Matrix System, its purpose, features, and benefits, with its front and back panel components described.

Chapter 2, Hardware Setup, provides step-by-step instructions for setting up your installation, and explains some basic operation procedures.

Chapter 3, OSD Operation, explains the fundamental concepts involved in operating the KX9970 / KX9970F, and provides a complete description of the On Screen Displays (OSDs) and the functions contained.

Chapter 4, Software Installation, explains the administrative procedures that are required to download and install the KVM over IP Matrix Manager on Windows and Linux systems.

Chapter 5, Browser / Telnet Operation, explains how to log in to the KVM over IP Matrix Manager with a web browser, and describes the various functions provided.

Chapter 6, System Status, explains how to use the KVM over IP Matrix Manager's system status panel to manage transmitters, receivers, switches, users, profiles, and logs.

Chapter 7, System Settings, explains the KVM over IP Matrix Manager's system settings, which are categorized into General, ANMS, LDAP/AD, RADIUS, TACACS+ authentication, F/W Upgrade, Redundancy, Backup/Restore, Certificates, and Sessions tabs.

Chapter 8, Connections, describes how to use the KVM over IP Matrix Manager's connections panel to quickly view, connect, and disconnect Transmitter-Receiver connections.

Chapter 9, Scheduled Profile, describes how to use the KVM over IP Matrix Manager's scheduled profile panel to view and manage profile schedules.

Chapter 10, Sessions, describes how to use the KVM over IP Matrix Manager's sessions panel to view and disconnect user sessions.

Chapter 11, ATEN Matrix Link, introduces the ATEN Matrix (Instant) Link app, which allows users to monitor and manage the CCKM server remotely from an iPad.

Chapter 12, Firmware Upgrade Utility, explains how to download and use the Firmware Upgrade Utility for upgrading the firmware of the devices connected.

Chapter 13, CLI Commands, provides a complete list of the serial protocol and TCP/IP commands used when utilizing the RS-232 serial port or a network connection to configure the KX devices.

Appendix, provides the technical and troubleshooting information of KX devices at the end of the manual.

Note:

- ◆ Read this manual thoroughly and follow the installation and operation procedures carefully to prevent any damage to the unit or connected devices.
 - ◆ The product may be updated, with features and functions added, improved or removed since the release of this manual. For an up-to-date user manual, visit <http://www.aten.com/global/en/>
-

Conventions

This manual uses the following conventions:

- | | |
|---|--|
| Monospaced | Indicates text that you should key in. |
| [] | Indicates keys you should press. For example, [Enter] means to press the Enter key. If keys need to be chorded, they appear together in the same bracket with a plus sign between them: [Ctrl+Alt]. |
| 1. | Numbered lists represent procedures with sequential steps. |
| ◆ | Bullet lists provide information, but do not involve sequential steps. |
| > | Indicates selecting consecutive options (such as on a menu or dialog box). For example, Start > Run means to open the <i>Start</i> menu, and then select <i>Run</i> . |
|  | Indicates critical information. |

This Page Intentionally Left Blank

Chapter 1

Introduction

Overview

The KX9970 / KX9970F 5K DisplayPort Single Display KVM over IP Extender consists of a high performance IPbased transmitter (KX9970T / KX9970FT) and a receiver (KX9970R / KX9970FR), where the transmitter can transmit a computer's keyboard, video, mouse, and USB signals to the receiver for providing separate console accesses from both the transmitter's and receiver's locations. The setup allows extended access to computer systems via a USB console (USB keyboard, USB mouse, DisplayPort monitor) over Intranet, enabling users to place the computers in secure and temperature-controlled environments, which may be isolated from the user workstation.

The KX9970 / KX9970F each support one DisplayPort video display for delivering video resolutions of up to 5K (5120 x 2880 @ 30 Hz), and offer flawless and lossless video quality with extremely low latency. Each KX9970 extender model is equipped with one RJ-45 port and two SFP+ slots while KX9970F is only equipped with two SFP+ slots. 10-Gbps SFP+ fiber module expansions are supported for fiber optic network connections and a transmission distance of up to 10 km. For connection flexibility, both the KX9970 transmitter and receiver models can be connected either directly to each other or via a high-speed network over a copper-based or fiber-based LAN. The KX9970 / KX9970F also features dual power supply capability for power redundancy to ensure reliable services. The KX9970 / KX9970F can be set up at the workstation, mounted onto a wall or at the rear of a rack with its space-saving 0U rack-mount design.

As an IP-based matrix extender, the KX9970 / KX9970F can be installed in flexible configurations, including point to point, point to multipoint, multipoint to point, and multipoint to multipoint. When combined with the KVM over IP Matrix Manager (CCKM), it can be integrated into a KVM over IP matrix system (multipoint-to-multipoint) for providing more flexible applications in different working environments.

By integrating CCKM with KX9970 / KX9970F, IT administrators can benefit from advanced features such as auto detection of all KX9970 / KX9970F devices on the same subnet for the sake of fast installation or configuration, username / password authentication and authorization, and the ability to define different types of connections that can be switched and shared. Security

features of the KX9970 / KX9970F include 256-bit AES encryption for secured data transmissions, as well as RADIUS, LDAP, Active Directory, TACACS+ for 3rd-party authentication services. In conclusion, the KX9970 / KX9970F is the most cost-effective and convenient way to provide full digital extension for control room applications through a network.

Note: The SFP+ module (2A-141G / 2A-142G) is sold separately. Contact your ATEN dealer for product information.

Features

Advanced Features¹

- ◆ Lossless video compression up to 5120 x 2880 including UHD or DCI with zero latency
- ◆ Native DP signal processing with color depth 24, 30, 36 bits
- ◆ Supports Adobe RGB
- ◆ Supports USB isochronous transfer to enable USB camera and USB speaker usage between transmitter and receiver
- ◆ ATEN Matrix Link – allows users to instantly link transmitters and receivers to perform real-time port and profile switching on an iPad
- ◆ Boundless Switching - simply moves the mouse cursor across screen borders to switch between different receivers (Rx)
- ◆ Push and Pull – shares content instantly to/from a single Rx or video wall by just one click
- ◆ Video walls – creates multiple video walls with up to 12 x 12 (144 displays max.) in each layout
- ◆ Advanced Scheduling – improves efficiency and saves costs by allowing connections to be set based on time and date
- ◆ Virtual Transmitter – independently streams video, audio, USB, and serial sources from different Tx
- ◆ Internal and external authentication support – supports LDAP, Active Directory, RADIUS and TACACS+
- ◆ Advanced User Authorization Settings – administrators can set up to four access modes on Tx devices for collaboration or prevention of interference among users
- ◆ Configurable user and group permissions for access and control of KX devices
- ◆ Tx grouping of up to 4 sets of KX transmitters to support multi-display applications
- ◆ Rx access control – users at the Tx local console can enable / disable Rx control privilege by simply pressing a control button²

Note: 1. These advanced functions are supported when the KX transmitters are paired with KX receivers and managed by CCKM.

2. The KVM over IP Access Control Box (2XRT-0015G) is sold separately. Contact your ATEN dealer for product information.

Hardware

- ◆ Supports DisplayPort video resolutions – up to 5120 x 1440 @ 60 Hz (4:4:4), 5120 x 2880 @ 30 Hz (4:4:4), 1920 x 1080 @ 240 Hz (4:4:4), 2560 x 1440 @ 144 Hz (4:4:4); 36-bit color depth
- ◆ DisplayPort 1.2
- ◆ Stereo speakers and microphone support
- ◆ High speed USB Storage Transmission support
- ◆ Auto-MDIX – automatically detects cable type
- ◆ Built-in 8 kV / 15 kV ESD protection and 2 kV surge protection
- ◆ Supports power redundancy – KX9970 / KX9970F has 2 DC jacks for power redundancy
- ◆ Supports network failover – 1 RJ-45 & 2 SFP+ slots for network failover to ensure constant availability for mission-critical applications (KX9970 only)
- ◆ Supports 10-Gbps SFP+ fiber module expansions for up to 10 km*
- ◆ Rack Mountable – Mounting options:
 - ◆ 2X-021G Dual Rack Mount Kit
 - ◆ 2X-031G Single Rack Mount Kit
- ◆ Includes an industrial-grade power adapter – supports operating temperature of 0-50 °C to ensure durability and adaptability under harsh environmental conditions

Note: *The SFP+ module (2A-141G / 2A-142G) is sold separately.
Contact your ATEN dealer for product information.

Management

- ◆ Integration with KVM over IP Matrix Manager (CCKM) – a software enabling easy configurations of all KX devices with an intuitive web-based GUI
- ◆ Dual console operation – controls user's system from both the transmitter's and receiver's keyboard, monitor, and mouse
- ◆ OSD (On Screen Display) – enables configuration of both Tx / Rx devices on the receiver's display screen

- ◆ EDID Expert™ – selects optimum EDID settings to prevent video compatibility issue caused by different monitors
- ◆ On-screen Preview (Panel Array™ Mode) – allows users to view the video of up to 36 displays on one screen
- ◆ Video Compression Level – allows users to increase / decrease the video quality to adjust for appropriate network bandwidth
- ◆ Command Line Interface – administrators can control all KX devices via RS-232 or Telnet by issuing commands or 3rd-party application
- ◆ Supports Hotkey Commands
- ◆ RS-232 serial ports – allows users to connect to a serial terminal for TextMenu, CLI, or to serial devices such as touch screens and barcode scanners
- ◆ All KX Tx models are compatible to be used with all Rx models

Security

- ◆ Dedicated LAN port for KX direct connections – can be isolated from the corporate network
- ◆ Secured data transmission – 256-bit AES encryption for all data being transmitted from the transmitter to the receiver
- ◆ Supports industry standard Transport Layer Security (TLS) protocol

Virtual Media

- ◆ Virtual Media mode enhances data transmission performance, and is ideal for file transfers, OS patching, software installations and diagnostic testing
- ◆ Supports USB 2.0 DVD / CD drives, USB mass storage devices, PC hard drives and ISO images
- ◆ Supports smart card / CAC reader

Supported Video Resolutions Requirements

| Resolutions | KX9970 / KX9970F |
|--|------------------|
| 24 bit | |
| 5120 x 2160 @ 50 Hz | • |
| 5120 x 2880 @ 30 Hz | • |
| 5120 x 1440 @ 60 Hz | • |
| 4096 x 2160 @ 60 Hz | • |
| 3840 x 2160 @ 60 Hz | • |
| 2560 x 1600 @ 60 Hz | • |
| 2560 x 1440 @ 60/144 (CVT-RB) Hz | • |
| 1920 x 1200 @ 60 Hz | • |
| 1920 x 1080 @ 60/120/144/240 (CVT-RB) Hz | • |
| 1600 x 1200 @ 60 Hz | • |
| 1280 x 1024 @ 60/75 Hz | • |
| 1152 x 864 @ 60/75 Hz | • |
| 1024 x 768 @ 60/75 Hz | • |
| 800 x 600 @ 60/75/85 Hz | • |
| 640 x 480 @ 60/75/85 Hz | • |
| 30 bit | |
| 3840 x 2160 @ 60 Hz (CVT-RB) | • |
| 2560 x 1600 @ 60 Hz | • |
| 2560 x 1440 @ 60Hz | • |
| 1920 x 1200 @ 60 Hz | • |
| 1920 x 1080 @ 60/120 Hz (CVT-RB) | • |
| 1600 x 1200 @ 60 Hz | • |
| 1280 x 1024 @ 60/75 Hz | • |
| 1152 x 864 @ 60/75 Hz | • |
| 1024 x 768 @ 60/75 Hz | • |
| 800 x 600 @ 60/75/85 Hz | • |
| 640 x 480 @ 60/75/85 Hz | • |
| 36 bit | |
| 1920 x 1080 @ 60 Hz | • |
| 1600 x 1200 @ 60 Hz | • |
| 1280 x 1024 @ 60/75 Hz | • |
| 1152 x 864 @ 60/75 Hz | • |
| 1024 x 768 @ 60/75 Hz | • |
| 800 x 600 @ 60/75/85 Hz | • |

| Resolutions | KX9970 / KX9970F |
|-------------------------|------------------|
| 640 x 480 @ 60/75/85 Hz | • |

Operating System

KX series devices are compatible with the following operating systems:

| OS | | Versions |
|---------|--------|--|
| Windows | 32-bit | 7 |
| | 64-bit | 7 / 8.1 / 10 / 11 / Server 2012 / Server 2016 / Server 2019 |
| Linux | | <ul style="list-style-type: none"> ◆ CentOS ◆ Ubuntu ◆ openSUSE ◆ Debian |

- ◆ Mac OS
- ◆ Oracle Solaris

Console

- ◆ (KX9970 / KX9970F) One DisplayPort compatible monitor capable of the highest possible resolution
- ◆ A USB mouse
- ◆ A USB keyboard
- ◆ Microphone and speakers

Computers

The following ports must be available on each computer that is to be connected to the system:

- ◆ (KX9970 / KX9970F) One DisplayPort port
- ◆ USB Type A port
- ◆ Audio ports

Cables

- ◆ For optimal signal integrity and to simplify the setup, we strongly recommend that you only use the high quality custom USB KVM Cable that is provided with this package.

CCKM Requirements

The minimum hardware and software requirements for the computer running the KVM over IP Matrix Manager are:

- ◆ Processor: Pentium 4, 2.60 GHz or above
- ◆ Memory: 1 GB or above
- ◆ HDD: 500 MB or above
- ◆ Web browser: Internet Explorer 10 (or later), Chrome 70 (or later), Firefox 62 (or later)
- ◆ Operating System Requirements:
 - ◆ Windows 7, 8.1, 10, server 2008, server 2012, or server 2016
 - ◆ Linux Ubuntu 16.04, CentOS 7

Note: Only Java Runtime Environment (JRE) 8 and OpenJDK 8 are supported.

Virtual Machine

CCKM supports the following virtual machine and versions:

| OS | | Versions |
|-----------|---------|---|
| VMware | ESXi | <ul style="list-style-type: none"> ◆ 4.x (4.0) ◆ 5.x (5.0, 5.1, 5.5) ◆ 6.x (6.0) |
| | vCenter | <ul style="list-style-type: none"> ◆ 2.5 ◆ 4.0 ◆ 5.x (5.0, 5.5) ◆ 6.x (6.0) |
| XenServer | | <ul style="list-style-type: none"> ◆ 5.x (5.6) ◆ 6.x (6.0, 6.5) ◆ 7.x (7.0) ◆ 8.x (8.0) |
| Hyper-v | | <ul style="list-style-type: none"> ◆ on Win 7 / 8.1 / 10 ◆ on Windows Server 2008 / 2012 / 2016 / 2019 |

Components

KX9970T (Transmitter) Front View

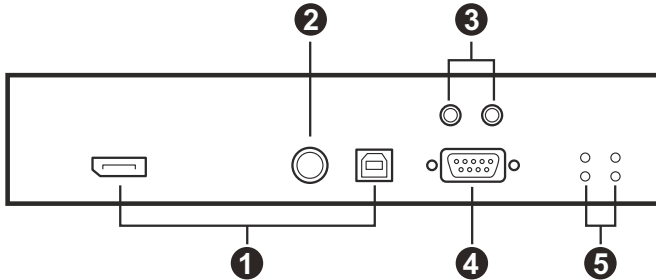

KX9970T (Transmitter) Rear View

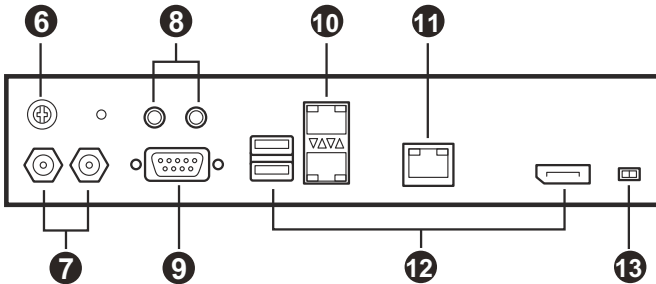

| No. | Component | Description |
|-------------------|------------------------------|---|
| Front View | | |
| 1 | KVM ports | The USB KVM cable supplied with the package that links the Transmitter to the computer plugs into these ports. |
| 2 | access control port | This access control port is for connecting the KVM over IP Access Control Box (2XRT-0015G). Note: The KVM over IP Access Control Box (2XRT-0015G) is sold separately. Contact your ATEN dealer for product information. |
| 3 | audio ports (PC / Server) | These mini stereo ports are for the speakers (green) and microphone (pink). |
| 4 | RS-232 port (PC / Server) | This RS-232 serial port is for connecting to the computer for serial control. |

| No. | Component | Description |
|------------------|---------------------------|--|
| 5 | power & status LEDs | <ul style="list-style-type: none"> ◆ Power: Lights green to indicate the unit is receiving power and turned on. ◆ Remote / Local: Lights green to indicate which side of the installation (Local or Remote) currently has KVM control of the computer. |
| Rear View | | |
| 6 | grounding terminal | The wire used to ground the unit connects here. |
| 7 | DC power jacks | The cable from the DC power adapter connects here. |
| 8 | audio ports (console) | These mini stereo ports are for the local speakers (green) and microphone (pink). |
| 9 | RS-232 serial device port | This RS-232 serial port is for connecting to a serial terminal. |
| 10 | SFP+ slots | <p>The 10 Gigabit Ethernet (10 GbE) optical fiber cable that connects the unit to the LAN plugs in here.</p> <p>Note: The SFP+ slot supports 10GBASE-R technology only.</p> |
| 11 | 10 Gb LAN port | <p>The cable that connects the unit to the LAN plugs in here.</p> <p>Note: The 10 Gb LAN port supports 1G / 2.5G / 5G / 10G NBASE-T technology.</p> |
| 12 | console ports | <ul style="list-style-type: none"> ◆ USB: The unit's USB keyboard and USB mouse plug into these ports. ◆ Video: The cable from the local DisplayPort monitor plugs in here. |
| 13 | function switch | <p>Use this slide switch to set the unit's mode to:</p> <ul style="list-style-type: none"> ◆ Auto: Shared (simultaneous) KVM control of the computer at the Transmitter and Receiver console.* If the auto mode is selected, the EDID mode will be automatically applied to a pre-configured setting in the basic transmitter configuration, see page Basic, page 99. ◆ RS-232 Config/Access Control: The device is ready to be configured via serial commands through the RS-232 port. When connected to a KVM over IP Access Control Box (2XRT-0015G), users can enable / disable control privileges of the connected receivers. ◆ Local: Only the local Transmitter has KVM control of the computer. The Receiver's KVM access to the computer is locked. If local mode is selected, the EDID of the Tx local console will be used. <p>In Auto mode, RS-232 and audio functions will work on the Receiver but not on the Transmitter.</p> |

KX9970R (Receiver) Front View

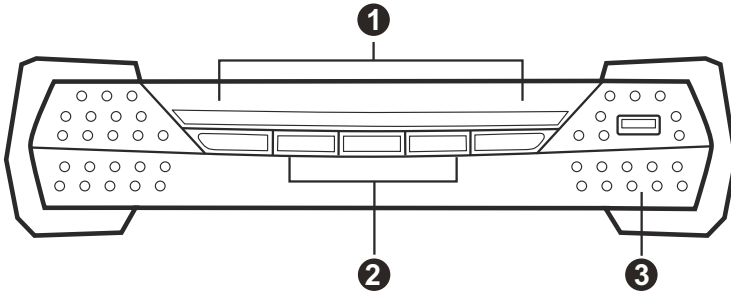

KX9970R (Receiver) Rear View

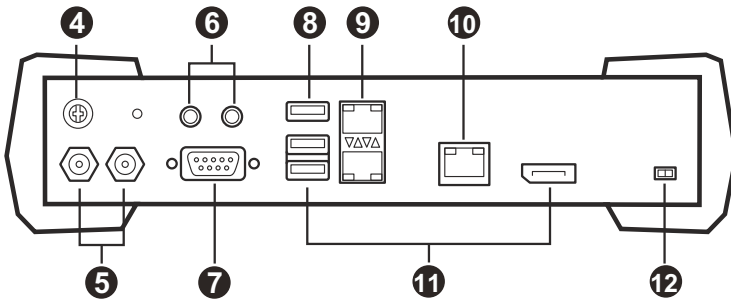

| No. | Component | Description |
|-------------------|-----------------------|--|
| Front View | | |
| 1 | power & status LEDs | <ul style="list-style-type: none"> ◆ Power: Lights green to indicate the unit is receiving power and turned on. ◆ Remote / Local: Lights green to indicate which side of the installation (Local or Remote) currently has KVM control of the computer. |
| 2 | operation pushbuttons | Use these pushbuttons to operate the OSD. |
| 3 | USB peripheral port | Use this port for virtual media or a USB peripheral device. Note: 1. When using a USB disk plugged into this port, see <i>USB Mode</i> , page 111. 2. This USB port supports isochronous endpoints. |
| Rear View | | |
| 4 | grounding terminal | The wire used to ground the unit connects here. |

| No. | Component | Description |
|-----|---------------------------|--|
| 5 | DC power jacks | The cable from the DC power adapter connects here. |
| 6 | audio ports (console) | These mini stereo ports are for the local speakers (green) and microphone (pink). |
| 7 | RS-232 serial device port | This RS-232 serial port is for connecting to a serial terminal. |
| 8 | USB peripheral port | <p>Use this port for virtual media or a USB peripheral device.</p> <p>Note: 1. When using a USB disk plugged into this port, see <i>USB Mode</i>, page 111.</p> <p>2. This USB port supports isochronous endpoints.</p> |
| 9 | SFP+ slots | <p>The 10 Gigabit Ethernet (10 GbE) optical fiber cable that connects the unit to the LAN plugs in here.</p> <p>Note: The SFP+ slot supports 10GBASE-R technology only.</p> |
| 10 | 10 Gb LAN port | <p>The cable that connects the unit to the LAN plugs in here.</p> <p>Note: The 10 Gb LAN port supports 1G / 2.5G / 5G / 10G NBASE-T technology.</p> |
| 11 | console ports | <ul style="list-style-type: none"> ◆ USB: The unit's USB keyboard and USB mouse plug into these ports. ◆ Video: The cable from the local DisplayPort monitor plugs in here. |
| 12 | function switch | <p>Use this slide switch to set the unit's mode:</p> <ul style="list-style-type: none"> ◆ Extension: Sets the device to use the normal TX to RX extension mode. <p>RS-232 Config: The device is ready to be configured via serial commands through the RS-232 port.</p> |

KX9970FT (Transmitter) Front View

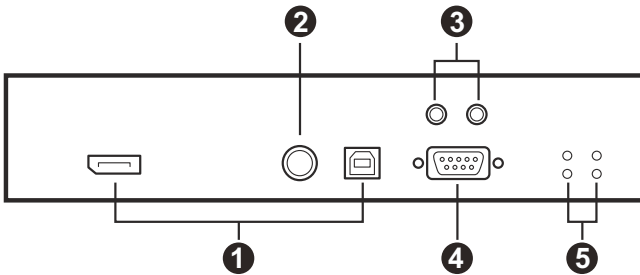

KX9970FT (Transmitter) Rear View

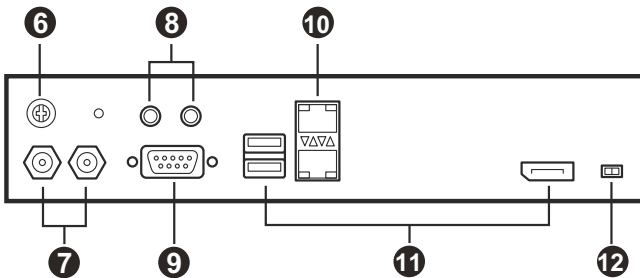

| No. | Component | Description |
|-------------------|------------------------------|---|
| Front View | | |
| 1 | KVM ports | The USB KVM cable supplied with the package that links the Transmitter to the computer plugs into these ports. |
| 2 | access control port | This access control port is for connecting the KVM over IP Access Control Box (2XRT-0015G). Note: The KVM over IP Access Control Box (2XRT-0015G) is sold separately. Contact your ATEN dealer for product information. |
| 3 | audio ports (PC / Server) | These mini stereo ports are for the speakers (green) and microphone (pink). |
| 4 | RS-232 port (PC / Server) | This RS-232 serial port is for connecting to the computer for serial control. |

| No. | Component | Description |
|------------------|---------------------------|--|
| 5 | power & status LEDs | <ul style="list-style-type: none"> ◆ Power: Lights green to indicate the unit is receiving power and turned on. ◆ Remote / Local: Lights green to indicate which side of the installation (Local or Remote) currently has KVM control of the computer. |
| Rear View | | |
| 6 | grounding terminal | The wire used to ground the unit connects here. |
| 7 | DC power jacks | The cable from the DC power adapter connects here. |
| 8 | audio ports (console) | These mini stereo ports are for the local speakers (green) and microphone (pink). |
| 9 | RS-232 serial device port | This RS-232 serial port is for connecting to a serial terminal. |
| 10 | SFP+ slots | <p>The 10 Gigabit Ethernet (10 GbE) optical fiber cable that connects the unit to the LAN plugs in here.</p> <p>Note: The SFP+ slot supports 10GBASE-R technology only.</p> |
| 11 | console ports | <ul style="list-style-type: none"> ◆ USB: The unit's USB keyboard and USB mouse plug into these ports. ◆ Video: The cable from the local DisplayPort monitor plugs in here. |
| 12 | function switch | <p>Use this slide switch to set the unit's mode to:</p> <ul style="list-style-type: none"> ◆ Auto: Shared (simultaneous) KVM control of the computer at the Transmitter and Receiver console.* If the auto mode is selected, the EDID mode will be automatically applied to a pre-configured setting in the basic transmitter configuration, see page Basic, page 99. ◆ RS-232 Config/Access Control: The device is ready to be configured via serial commands through the RS-232 port. When connected to a KVM over IP Access Control Box (2XRT-0015G), users can enable / disable control privileges of the connected receivers. ◆ Local: Only the local Transmitter has KVM control of the computer. The Receiver's KVM access to the computer is locked. If local mode is selected, the EDID of the Tx local console will be used. <p>In Auto mode, RS-232 and audio functions will work on the Receiver but not on the Transmitter.</p> |

KX9970FR (Receiver) Front View

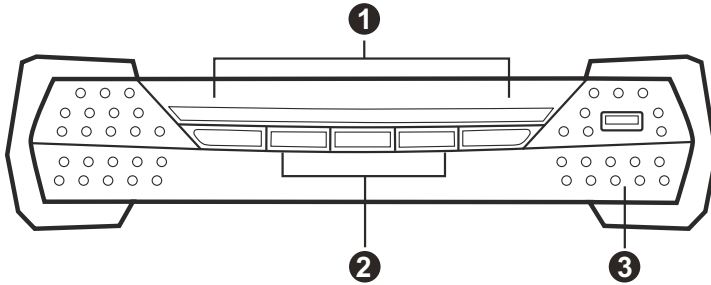

KX9970FR (Receiver) Rear View

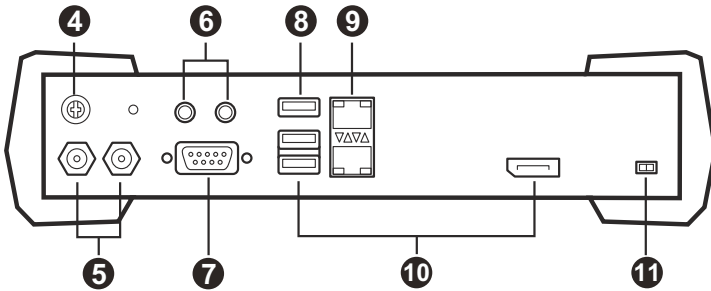

| No. | Component | Description |
|-------------------|-----------------------|--|
| Front View | | |
| 1 | power & status LEDs | <ul style="list-style-type: none"> ◆ Power: Lights green to indicate the unit is receiving power and turned on. ◆ Remote / Local: Lights green to indicate which side of the installation (Local or Remote) currently has KVM control of the computer. |
| 2 | operation pushbuttons | Use these pushbuttons to operate the OSD. |
| 3 | USB peripheral port | <p>Use this port for virtual media or a USB peripheral device.</p> <p>Note: 1. When using a USB disk plugged into this port, see <i>USB Mode</i>, page 111.</p> <p>2. This USB port supports isochronous endpoints.</p> |
| Rear View | | |
| 4 | grounding terminal | The wire used to ground the unit connects here. |
| 5 | DC power jacks | The cable from the DC power adapter connects here. |

| No. | Component | Description |
|-----|---------------------------|--|
| 6 | audio ports (console) | These mini stereo ports are for the local speakers (green) and microphone (pink). |
| 7 | RS-232 serial device port | This RS-232 serial port is for connecting to a serial terminal. |
| 8 | USB peripheral port | Use this port for virtual media or a USB peripheral device. Note: 1. When using a USB disk plugged into this port, see <i>USB Mode</i> , page 111. 2. This USB port supports isochronous endpoints. |
| 9 | SFP+ slots | The 10 Gigabit Ethernet (10 GbE) optical fiber cable that connects the unit to the LAN plugs in here. Note: The SFP+ slot supports 10GBASE-R technology only. |
| 10 | console ports | ◆ USB: The unit's USB keyboard and USB mouse plug into these ports. ◆ Video: The cable from the local DisplayPort monitor plugs in here. |
| 11 | function switch | Use this slide switch to set the unit's mode: ◆ Extension: Sets the device to use the normal TX to RX extension mode. RS-232 Config: The device is ready to be configured via serial commands through the RS-232 port. |

This Page Intentionally Left Blank

Chapter 2

Hardware Setup



1. Important safety information regard the placement of this device is found on. Please review it before proceeding.
2. Make sure that the power of all devices to be connected is turned off. You must unplug the power of any computers with Keyboard Power-on function.
3. Please operate the device with caution when under high environmental temperatures, as the surface of the device may become overheated under such conditions. For instance, the surface temperature of the device may reach 70 °C (158 °F) or higher when the environmental temperature reaches close to 50 °C (122 °F).
4. The KX9970 / KX9970F is not HDCP supported.

Mounting

For convenience and flexibility, the transmitters can be mounted onto a system racks or wall.

Note: Optional mounting options are available, refer to *Optional Rack Mount* on page 224 for more information.

It is highly recommended to mount KX Series unit(s) onto a system rack or wall and avoid a stacked setup to ensure proper ventilation.

The following sections demonstrate how to mount transmitters using the mounting kit provided.

Attaching the Mounting Bracket

Follow the steps below to attach the mounting bracket to the unit:

1. Unscrew the screws from the side, as shown in the diagram below.

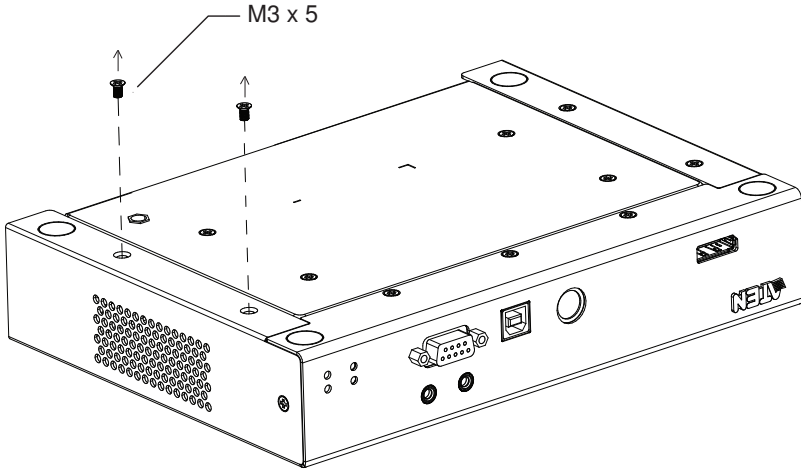

2. Use the screws from step 1 to attach the mounting bracket to the bottom of the transmitter, as shown below.

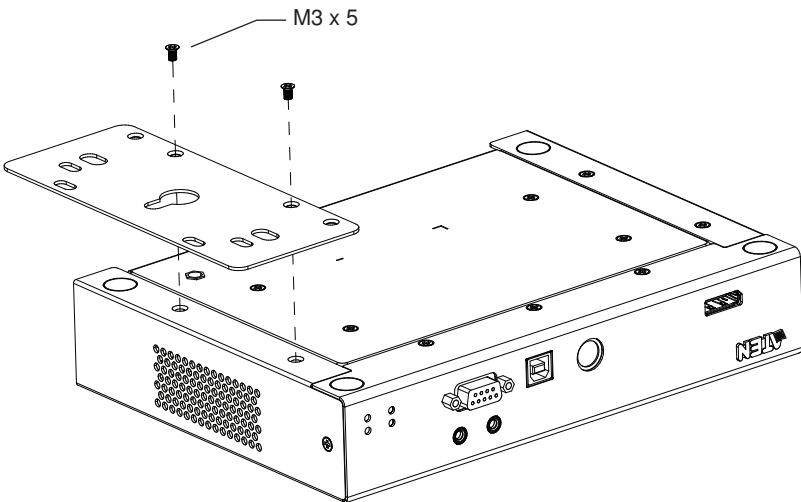

Rack Mount

Screw the mounting bracket on a convenient location of the rack.

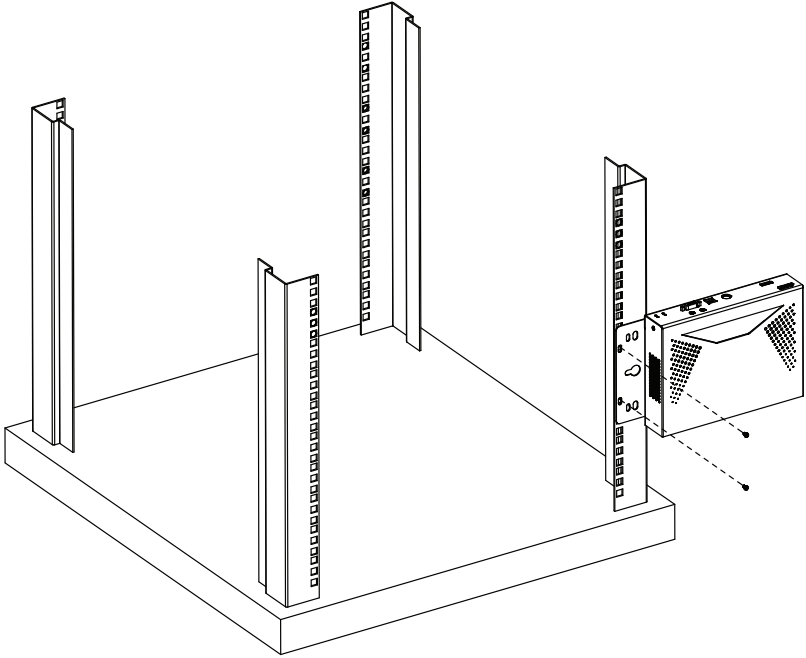

Note: Rack screws are not provided. We recommend the use of M5 x 12 Phillips Type I cross recessed screws.

Wall Mount

Use the center hole to screw the mounting bracket onto a secure wall surface.

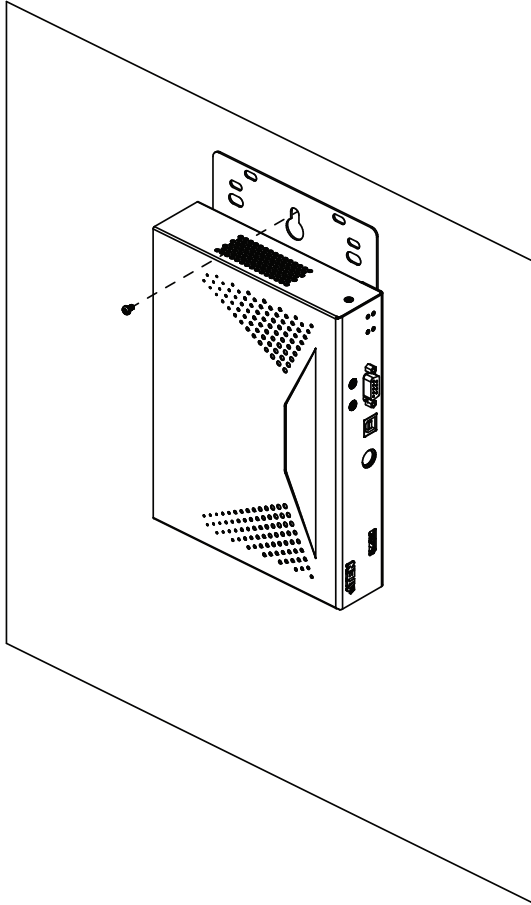

KX9970 Point-to-Point Installation

Setting up the KX9970 system in a point-to-point configuration is simply a matter of plugging in the cables.

Note: In a point-to-point configuration, no administrator setup is required.

Make sure that all equipment is powered off. Refer to the installation diagrams on the next two pages and do the following:

1. Use a grounding wire to ground the unit by connecting one end to the grounding terminal and the other end to a suitable grounded object.

Note: Do not omit this step. Proper grounding helps prevent damage to the unit from power surges or static electricity.

2. For KX9970T only, do the following:
 - a) Using the DisplayPort cable and USB Type-A to Type-B cable provided, connect the unit's KVM ports to the video and USB ports of the PC / server you are controlling.
 - b) (Optional) For audio transmission, connect the unit's front audio ports to those of the PC / server.
 - c) (Optional) For control of serial devices, connect the unit's front RS-232 serial port to that of the PC / server.
 - d) (Optional) To use a 2XRT-0015G, connect it to the unit's PS/2 access control port.
3. For console operation, connect the unit's console ports to a USB keyboard & mouse, DisplayPort monitor, microphone, speakers, and/or serial console device as needed.
4. (Optional) For KX9970R only, to use peripheral USB devices, connect up to 2 to the unit's 2 USB peripheral ports.

Note: The USB peripheral ports are isochronous endpoints compatible and thus support video and audio streaming.

5. Connect the unit to power, thereby turning it on, by plugging the power adapter provided into an AC power source and plugging its cable into 1 of the unit's 2 DC power jacks.

Note: For power redundancy, optionally connect a second power adapter into another AC power source and connect its other end to the unit's second DC power jack.

6. For KX9970T, power on the PC / server.

Extending KX9970T — KX9970R

7. Every KX9970 (Tx / Rx) is equipped with two SFP+ slots and one 10-Gb LAN port. For extending control from a KX9970T to a KX9970R, it can be established using fiber-optic and/or Cat 5e/6 cables through one of the following methods:

- ◆ Connect them directly, point-to-point, via their SFP+ slots and/or LAN port.
- ◆ Connect them to the same network via their SFP+ slots and/or LAN port. For LAN installation, see *KX9970 LAN Installation*, page 29.

Note: All KX9970 installed with the same network can be managed using CCKM, ATEN's dedicated KVM over IP Matrix Manager.

KX9970 Point-to-Point Installation Diagram

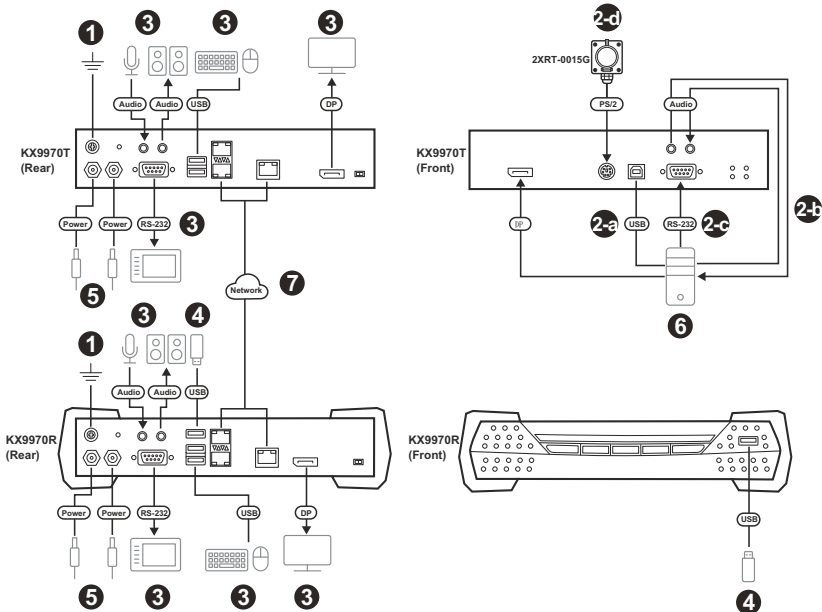

Note:

- ◆ For the advanced features of connecting a keyboard or mouse with special functions, see *USB Mode*, page 111.
 - ◆ The SFP+ module 2A-141G / 2A-142G is sold separately. Contact your ATEN dealer for product information,
 - ◆ The second power adapter with the power cord is sold separately. Contact your ATEN dealer for product information.
-

KX9970F Point-to-Point Installation

Setting up the KX9970F system in a point-to-point configuration is simply a matter of plugging in the cables.

Note: In a point-to-point configuration, no administrator setup is required.

Make sure that all equipment is powered off. Refer to the installation diagrams on the next two pages and do the following:

1. Use a grounding wire to ground the unit by connecting one end to the grounding terminal and the other end to a suitable grounded object.

Note: Do not omit this step. Proper grounding helps prevent damage to the unit from power surges or static electricity.

2. For KX9970FT only, do the following:
 - a) Using the DisplayPort cable and USB Type-A to Type-B cable provided, connect the unit's KVM ports to the video and USB ports of the PC / server you are controlling.
 - b) (Optional) For audio transmission, connect the unit's front audio ports to those of the PC / server.
 - c) (Optional) For control of serial devices, connect the unit's front RS-232 serial port to that of the PC / server.
 - d) (Optional) To use a 2XRT-0015G, connect it to the unit's PS/2 access control port.
3. For console operation, connect the unit's console ports to a USB keyboard & mouse, DisplayPort monitor, microphone, speakers, and/or serial console device as needed.
4. (Optional) For KX9970FR only, to use peripheral USB devices, connect up to 2 to the unit's 2 USB peripheral ports.

Note: The USB peripheral ports are isochronous endpoints compatible and thus support video and audio streaming.

5. Connect the unit to power, thereby turning it on, by plugging the power adapter provided into an AC power source and plugging its cable into 1 of the unit's 2 DC power jacks.

Note: For power redundancy, optionally connect a second power adapter into another AC power source and connect its other end to the unit's second DC power jack.

- For KX9970FT, power on the PC / server.

Extending KX9970FT — KX9970FR

- Every KX9970 (Tx / Rx) is equipped with two SFP+ slots. For extending control from a KX9970FT to a KX9970FR, it can be established using fiber-optic cables through one of the following methods:
 - Connect them directly, point-to-point, via their SFP+ slots.
 - Connect them to the same network via their SFP+ slots. For LAN installation, see *KX9970F LAN Installation*, page 31.

Note: All KX9970 installed with the same network can be managed using CCKM, ATEN's dedicated KVM over IP Matrix Manager.

KX9970F Point-to-Point Installation Diagram

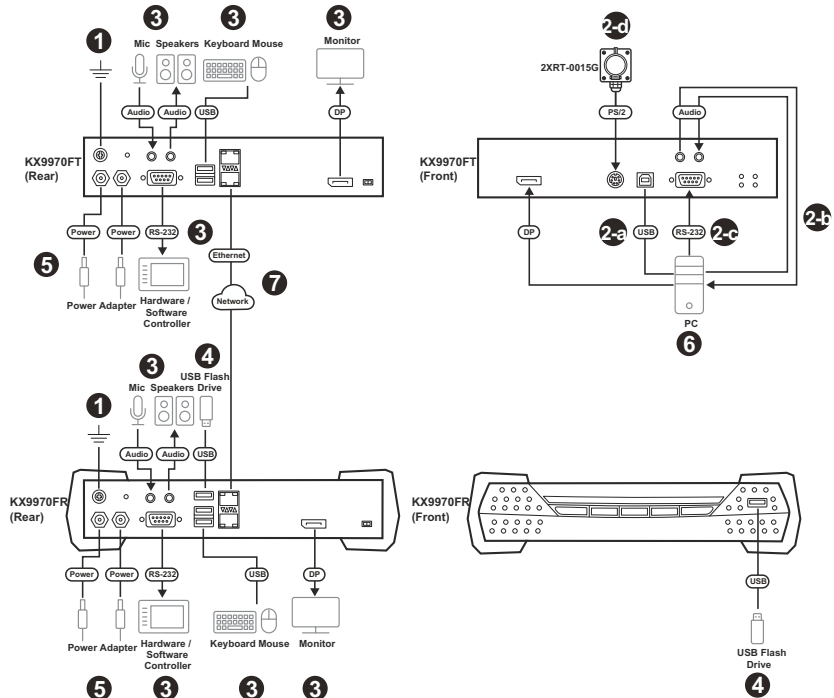

Note:

- ◆ For the advanced features of connecting a keyboard or mouse with special functions, see *USB Mode*, page 111.
 - ◆ The SFP+ module 2A-141G / 2A-142G is sold separately. Contact your ATEN dealer for product information,
 - ◆ The second power adapter with the power cord is sold separately. Contact your ATEN dealer for product information.
-

KX9970 LAN Installation

Setting up the units on a network allows point-to-point, point-to-multipoint, and multipoint-to-multipoint computer to console operation by connecting multiple KX9970 devices on the same TCP/IP LAN. Prior to the setup, we recommend laying out the plans for your KX installation using our performance guide (see *Keys to Network Performance*, page 238).

A few points to note during your setup:

- ◆ The units are preconfigured with factory-default network settings. If you install only one set of KX Series units, you do not need to change these default network settings. See *Default IP Addresses*, page 34, for further details.
- ◆ In a network setup with multiple units, each Transmitter and Receiver must be configured with a unique IP address. See *Network Configuration*, page 33, for further details.
- ◆ We recommend using 10 Gigabit Ethernet switches (wire speeds, non-blocking with 10 Gbps performance per port) between KX Series devices installed on different LAN segments under a same office network environment. Switches with bandwidth less than 10 Gbps might cause poor performance.
- ◆ In multipoint configurations, the IGMP and flow control function of your network switches/hubs must be enabled to avoid the deterioration of data throughput. To ensure functionality use a layer 3 switch that supports IGMP queries.
- ◆ If your network uses cascaded switches, please check to ensure the data throughput is sufficient.
- ◆ To get the best performance, we suggest creating a private network for KX devices, as they are bandwidth-intensive devices.
- ◆ The unit supports network redundancy. Where both LAN and SFP+ ports are connected, a network redundancy is established. Please note that if you use copper SFP+ modules, the module has to be removed for the unit to switch to the LAN port's network.
- ◆ For USB keyboards / mice with advanced function designs, see *USB Mode*, page 111.
- ◆ Make sure that all equipment is powered off.

The installation is similar to that of *KX9970 Point-to-Point Installation* on page 23, with the difference in connecting the transmitter and the receiver to a local area TCP/IP network. Refer to the diagrams on the following page and connect accordingly.

Repeat these steps for each Transmitter and Receiver you wish to install on the network then power on the computer(s).

KX9970 Network Installation Diagram

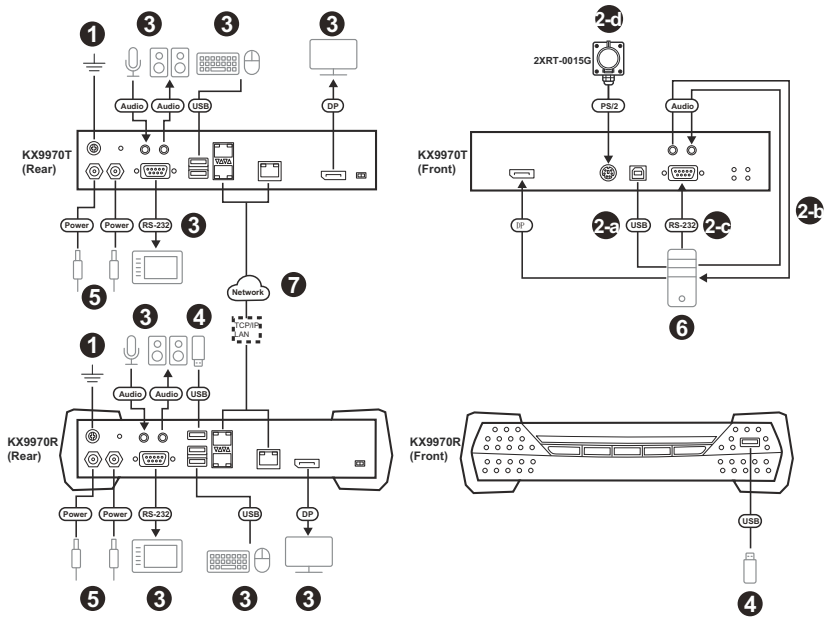

KX9970F LAN Installation

Setting up the units on a network allows point-to-point, point-to-multipoint, and multipoint-to-multipoint computer to console operation by connecting multiple KX9970F devices on the same TCP/IP LAN. Prior to the setup, we recommend laying out the plans for your KX installation using our performance guide (see *Keys to Network Performance*, page 238).

A few points to note during your setup:

- ◆ The units are preconfigured with factory-default network settings. If you install only one set of KX Series units, you do not need to change these default network settings. See *Default IP Addresses*, page 34, for further details.
- ◆ In a network setup with multiple units, each Transmitter and Receiver must be configured with a unique IP address. See *Network Configuration*, page 33, for further details.
- ◆ We recommend using 10 Gigabit Ethernet switches (wire speeds, non-blocking with 10 Gbps performance per port) between KX Series devices installed on different LAN segments under a same office network environment. Switches with bandwidth less than 10 Gbps might cause poor performance.
- ◆ In multipoint configurations, the IGMP and flow control function of your network switches/hubs must be enabled to avoid the deterioration of data throughput. To ensure functionality use a layer 3 switch that supports IGMP queries.
- ◆ If your network uses cascaded switches, please check to ensure the data throughput is sufficient.
- ◆ To get the best performance, we suggest creating a private network for KX devices, as they are bandwidth-intensive devices.
- ◆ The unit supports network redundancy. Where both LAN and SFP+ ports are connected, a network redundancy is established. Please note that if you use copper SFP+ modules, the module has to be removed for the unit to switch to the LAN port's network.
- ◆ For USB keyboards / mice with advanced function designs, see *USB Mode*, page 111.
- ◆ Make sure that all equipment is powered off.

The installation is similar to that of *KX9970F Point-to-Point Installation* on page 26, with the difference in connecting the transmitter and the receiver to a local area TCP/IP network. Refer to the diagrams on the following page and connect accordingly.

Repeat these steps for each Transmitter and Receiver you wish to install on the network then power on the computer(s).

KX9970F Network Installation Diagram

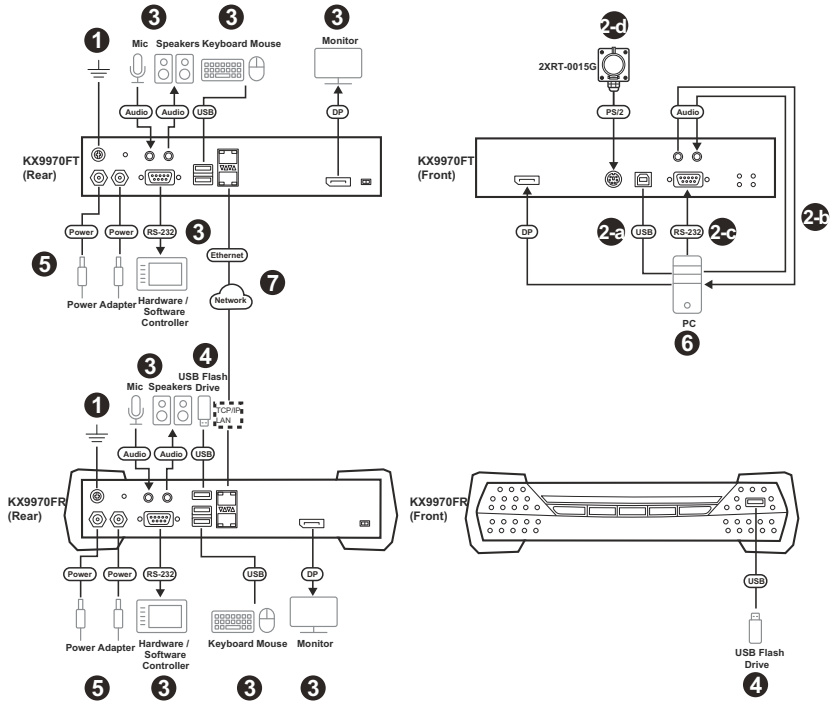

Network Configuration

This section provides instructions to configure the network settings with a fixed IP address, subnet mask, and default gateway. To use the **IP Installer** to configure the IP address, see *IP Installer*, page 230.

-
- Note:**
1. Both devices are preconfigured with factory-default network settings. If you install only one set of KX Series units, you do not need to change these default network settings. See *Default IP Addresses*, page 34, for further details.
 2. In a network setup with multiple units, each transmitter and receiver must be configured with a unique IP address. See *Network Configuration*, page 33, for further details.
 3. We recommend using 10 Gigabit Ethernet switches (wire speeds, non-blocking with 10 Gbps performance per port) between KX Series devices installed on different LAN segments under a same office network environment. Switches with bandwidth less than 10 Gbps might cause poor performance.
 4. In multipoint configurations, the IGMP and flow control function of your network switches/hubs must be enabled to avoid the deterioration of data throughput. To ensure functionality use a layer 3 switch that supports IGMP queries.
 5. If your network uses cascaded switches, please check to ensure the data throughput is sufficient.
 6. To get the best performance, we suggest creating a private network for KX device, as they are bandwidth-intensive devices.
-

To configure the network settings, do the following:

1. Set up the hardware and connect the transmitter and receiver to the local area network (see *KX9970 LAN Installation*, page 29, or *KX9970F LAN Installation*, page 31).
2. From the receiver, tap **[Scroll Lock]** twice to invoke the OSD.
3. Select the *Receiver* or *Transmitter* from the sidebar menu.
4. Enter the password and click **Configure**.

The default password is: password.

5. From the *Network* tab, select **Set IP address manually** and enter the following:

- ♦ *IP Address* — sets the IP address for the KX device. Key in a valid unique IP address.

Note: See *Default IP Addresses*, page 34, for the preconfigured factory-default settings.

- ♦ *Subnet Mask* — sets the subnet mask for the KX device. Key in a valid subnet mask value.

Note: The default setting is 255.255.255.0

- ♦ *Default Gateway* — sets the default gateway for the KX device. Key in a valid default gateway.

6. Click **Save**.

Exit OSD

To exit the OSD, press **[Esc]** on the keyboard, click **Logout**; tap **[Scroll Lock]** twice, or return to the OSD main page and press the front panel OSD pushbutton (receiver only).

At this point, the receiver can connect to the transmitter to access the remote computer (see *OSD Matrix Mode*, page 52 for instructions).

Default IP Addresses

The preconfigured factory-default IP addresses for the KX Series devices are as follows:

Transmitters – 192.168.0.61

Receivers – 192.168.0.60

Note: Only use factory-default IP address if the DHCP is not present or if the initial configuration is done in PTP mode because DHCP is supported.

KX I/O Ports

The following table provides the I/O port use of KX Series devices.

| Device | Port | Number |
|----------------------------------|------------------|-------------------------------|
| KVM over IP Matrix Manager (TCP) | HTTP | 8080 |
| | HTTPS | 8443 |
| | Device TCP | 9110 |
| | CLI | 9111 |
| | Redundancy | 9120 |
| | Database Service | 1527 |
| KVM over IP Matrix Manager (UDP) | Port | 9110 |
| | Broadcast | 9000 |
| KX TX/RX Device (TCP) | Manager | 9110 |
| | Service | 9000 |
| | Telnet | 23 |
| | SSH | 22 |
| KX TX Device (TCP) | VM | 9001 |
| | vUSB | 9002 |
| | Serial | 9003 |
| | USB Access Mode | 9009 |
| KX RX Device (TCP) | CLI | 9130 |
| KX TX/RX Device (UDP) | Manager | 9110 |
| | Service | 9000 |
| | Array Mode | 9120 |
| | Video | 0xFE00(65024) - 0xFE03(65027) |
| | Audio | 0xFE04(65028) - 0xFE05(65029) |

LED Display

Both the Transmitter and Receiver have front and rear panel LEDs to indicate their operating and power status, as explained in the table below:

Front Panel

| LED | Indication |
|--------|--|
| LAN | <ul style="list-style-type: none">◆ Lights green to indicate the network status is stable.◆ Off when there is no network connection.. |
| Power | <ul style="list-style-type: none">◆ Lights green when the unit is powered on.◆ OFF when power is off. |
| Local | <ul style="list-style-type: none">◆ Lights green to Indicate the Transmitter has KVM focus of the computer |
| Remote | <ul style="list-style-type: none">◆ Lights green to Indicate the Receiver has KVM focus of the computer. |

Rear Panel

| LED | Indication |
|-----|--|
| LAN | <p>This LED indicates the network status.</p> <ul style="list-style-type: none">◆ Lights when connected to the LAN and blinks when the Ethernet connection is active:<ul style="list-style-type: none">◆ Link LED (Left):<ul style="list-style-type: none">◆ Green: 10 Gbps◆ Orange: 1 Gbps◆ Active LED (Right):<ul style="list-style-type: none">◆ Green: 10 Gbps◆ Orange: 1 Gbps◆ Off when not connected to the LAN. |

Chapter 3

OSD Operation

Overview

This chapter provides instructions to configure and operate KX Series devices using the local On Screen Display (OSD). To configure the network settings with the OSD, see *Network Configuration*, page 33.

Invoking the OSD

The On Screen Display (OSD) is a keyboard/mouse-driven application on the receiver used to configure the transmitter and receiver settings. Once the receiver has discovered the transmitter over a network* or Ethernet cable connection, you can use the OSD on the receiver to configure the transmitter.

To invoke the OSD, press the OSD pushbutton on the front of the receiver, or from the keyboard tap the **Scroll Lock** key twice. The *OSD* main page will appear (see *Press the Esc key to cancel.*, page 39).

To exit the OSD, press **[Esc]** on the keyboard; click **Logout**; tap the **Scroll Lock** key twice; or return to the OSD main page and press the OSD pushbutton on the front of the receiver. The OSD disappears and the computer desktop screen or the System Login prompt is displayed.

-
- Note:**
1. For the Receiver to discover the Transmitter over a network, both must be on the same subnet of the LAN.
 2. To change the OSD hotkeys, see page 51.
 3. If the keyboard/mouse won't work when the OSD is invoked, see *USB Mode*, page 111.
-

Touch Screen Calibration

If you're using a touch screen monitor and the OSD appears off center, you can use the blinking **+** at each corner to adjust the position of the OSD.

OSD Hotkeys

The OSD hotkeys navigate the Receiver's OSD screens. The hotkeys work after logging in from the *System Login* screen (see page 52) but not the *OSD Configuration* screen. Pressing a hotkey will immediately take you to the corresponding OSD screen.

| Hotkey | OSD Screen | Page |
|--------|-------------------------------------|------|
| [F1] | Connections Page 1 in List Mode | 53 |
| [F2] | Connections Page 1 in Array Mode | 56 |
| [F3] | Profile Page 1 | 58 |
| [F5] | Push Content Page 1 | 59 |
| [F6] | Pull Content Page 1 | 61 |
| [F7] | Receiver > Properties | 42 |
| [F8] | User Preferences | 51 |
| [F9] | OSD Login Screen (logs user off) | 52 |

Users can also use the [Page Up] and [Page Down] keys to jump to the previous and next configuration pages.

Non-OSD Hotkeys

The following are the hotkeys that can be used without entering the OSD screen:

Reverting to Previous

Users can use the [Alt] + [K] hotkey to switch back to the transmitter channel previously accessed.

Hotkey Mode

The Hotkey Mode allows users to quickly switch from one transmitter to another. Either press [Num Lock] + [-] or [Ctrl] + [F12] to enter Hotkey Mode.

Once in Hotkey Mode, you can use the [Next Arrow] and [Previous Arrow] keys to quickly switch between different transmitters. You can also press a [Number Key] + [S] / [O] / [E] / [V] to access a transmitter based on its order number in Favorites (see page 54) by Share / Occupy / Exclusive / View Only mode.

Microphone Hotkey

You can switch microphone access between Receivers with a hotkey:

1. Press and hold down [Num Lock].
2. Press and release [-].
3. Release [Num Lock].
4. Press 1.

Press the **Esc** key to cancel.

OSD Interface

After you invoke the OSD, the main page appears:



Note: A password is required to enter the OSD. The default password is: *password*. For security purposes, the system will prompt you to change the password.

The OSD components are described in the table below:

| No. | Item | Description |
|-----|----------|---|
| 1 | Receiver | Select this radio button, enter a password, and click Configure to enter the <i>Receiver Configuration</i> screen. |

| No. | Item | Description |
|-----|--------------------|--|
| 2 | Transmitter | Select this radio button, enter a password, and click Configure to enter the <i>Transmitter Configuration</i> screen. Note: Receiver must first discover the transmitter over the network for this option to be available. |
| 3 | User Preferences | Select this radio button, enter a password, and click Configure to enter the <i>User Preferences</i> screen. |
| 4 | About | About provides information regarding the OSD version. |
| 5 | Password | Input the OSD password and click Configure to enter the selected configuration screen. See note for password. |
| 6 | Configure | After entering a password, click Configure to enter the selected configuration screen. |
| 7 | Back to Connection | Clicking this button exits the OSD and returns you to the computer's video display. |

Logging in for the First Time

If you are the administrator, and are logging in for the first time (Receiver or User Preference radio button), use the default password (*password*).

For security purposes, the system will prompt you to change the login password immediately as shown below:



Click **OK** and change the password in the dialog box shown below:



Enter the password and confirm it in the next field. The password must be different from your original password.

Receiver Configuration

Select the *Receiver* radio button and click **Configure** to login, the Network tab appears:

The screenshot shows the KX OSD interface. On the left, a sidebar contains menu items: Receiver (selected), Transmitter, User Preferences, About, and Logout. Below the sidebar is a 'Password' field and a 'Configure' button. The main area has three tabs: Network (selected), Properties, and System. Under the 'Network' tab, there are two sections: 'IP Installer' with radio buttons for 'Enable' (selected), 'View Only', and 'Disabled'; and 'Network Configuration' with radio buttons for 'Obtain IP address automatically' and 'Set IP address manually' (selected). Below these are three input fields: 'IP Address' (192.168.0.71), 'Subnet Mask' (255.255.255.0), and 'Default Gateway' (192.168.0.254). A 'Save' button is located at the bottom right of the main area.

Network

The Network tab allows you to configure the Receiver's IP address settings:

| Item | Description |
|-----------------------|--|
| IP Installer | <p>The IP Installer is an external Windows-based utility for assigning an IP address to the device. Click one of the radio buttons to select Enable, View Only, or Disable for the IP Installer utility. See <i>IP Installer</i>, page 230 for instructions.</p> <p>Note: For security, we strongly recommend that you set this to <i>View Only</i> or <i>Disable</i> after each use.</p> |
| Network Configuration | <p>For dynamic IP address assignment (DHCP), select the Obtain IP address automatically radio button.</p> <p>To specify a fixed <i>IP Address</i>, <i>Subnet Mask</i>, and <i>Default Gateway</i> select the Set IP address manually radio button and fill in the fields with values appropriate for your network.</p> <p>For help configuring network settings with the OSD, see <i>Network Configuration</i>, page 33.</p> |

After entering the information, click **Save**.

Properties

There are two versions of Properties for KX Series, a Regular Version, and a Slim Version.

The *Properties* tab allows you to configure the Receiver’s settings.

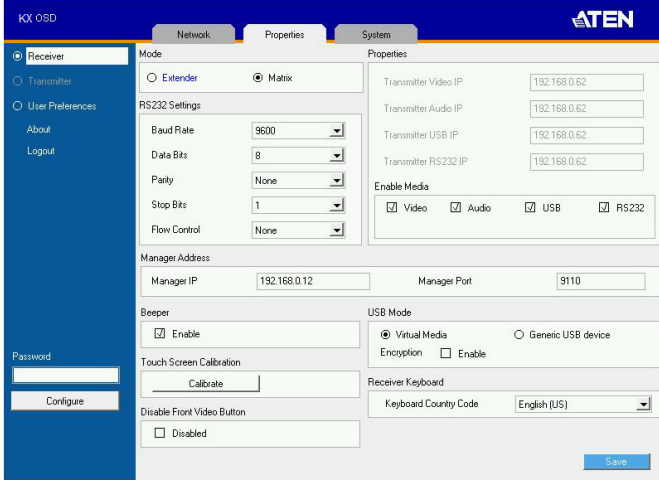

| Item | Description |
|------------|--|
| Mode | <p>Select Extender mode for simple one-to-one (Transmitter to Receiver) setups that are managed with the Receiver’s OSD menu.</p> <p>Select Matrix mode to manage devices and connections from the KVM over IP Matrix Manager web GUI. This mode is for advanced administration of Transmitter to Receiver connections (see <i>Browser / Telnet Operation</i>, page 75).</p> |
| Properties | <p>If you selected Extender mode (above) set the Transmitter IP address for the Receiver’s Video, Audio, USB, and RS232 source signals.</p> <p>If you selected Matrix mode (above) the <i>Properties</i> will be grayed out. Use Channels to configure the Transmitter connections (see <i>Browser / Telnet Operation</i>, page 75).</p> |

| Item | Description |
|--------------------------|---|
| RS232 Settings | Configure the serial device settings for the Receiver. The default settings are: Baud Rate: 9600 Parity: None Data Bits: 8 bits Stop bits: 1 bit Flow Control: None |
| Enable Media | Select which type of media the Receiver can stream from Transmitters: Video, Audio, USB, and RS232. |
| Manager Address | Set the IP address and Port number of the computer running the KVM over IP Matrix Manager. The default port number is 9110. |
| Beeper | Check this box to allow the Receiver to beep when configuration changes are made to it. |
| Touch Screen Calibration | Use this button to calibrate the surface of a USB touch screen connected to the unit. When the calibration screen appears, touch the flashing + symbol at each corner until the process is complete. |
| USB Mode | Select the type of USB device you will connect to the USB ports: Virtual Media: Only select this option if you are plugging a USB flash drive into the USB ports. This will give you the highest data transfer speeds but cannot work with other USB devices. When Receivers mount or unmount USB flash drives, the keyboard and mouse operations will experience a brief delay. Each Transmitter and Receiver can respectively support up to 12 and 3 virtual media connections at the same time (including Tx local console USB keyboard and mouse). vUSB (generic USB device): Use this option to plug USB peripherals into the USB ports. In this mode, all Receivers support up to 2 USB connections, and all Transmitters support up to 5 USB connections (including Tx local console USB keyboard and mouse). Note: The vUSB option also allows a keyboard and mouse with special functions to be plugged into the USB ports for console use. Use this only if the special functions of the keyboard or mouse are required but do not work when plugged into the console ports. When the keyboard and mouse are plugged into the USB ports, they will not work within the OSD menus. To work within the OSD menus, the keyboard and mouse must be plugged into the console ports. Encryption: Check this box to encrypt USB drives plugged into the USB ports. |

| Item | Description |
|----------------------------|---|
| Receiver Keyboard | Use the Keyboard Country Code drop-down menu to select the Receiver's language keyboard for use in the OSD. |
| Disable front video button | You can enable or disable the function (select video mode or graphic mode) of the video pushbutton on the front of the receiver. Check Disable to disable. Uncheck Disable to enable. |

After entering the information, click **Save**.

System

The *System* tab allows you to configure the Receiver's general settings:

The screenshot shows the 'System' configuration page. At the top, there are three tabs: 'Network', 'Properties', and 'System'. The 'System' tab is selected. Below the tabs, the page is divided into three main sections:

- Device Information:** This section contains several input fields and labels:
 - Name:** A text box containing 'KX9970R'.
 - Description:** An empty text box.
 - IP Address:** '192.168.0.60'.
 - MAC Address:** '00:10:74:a8:01:37'.
 - F/W Version:** 'V1.1.106 (May 2 2014 13:39:47)'.
 - Serial Number:** An empty text box.
- Reboot:** This section has a checkbox labeled 'Reset to factory default' which is currently unchecked, and a 'Reboot' button.
- User Station Password Change:** This section has a checked checkbox labeled 'Enable'. Below it are three password input fields: 'Old Password', 'New Password', and 'Confirm Password', each with a masked password (represented by asterisks).

A blue 'Save' button is located at the bottom right of the configuration area.

| Item | Description |
|--------------------|--|
| Device Information | Enter the Name , and Description of the Receiver. It also displays the <i>IP Address</i> , <i>MAC Address</i> , <i>F/W Version</i> , and <i>Serial Number</i> of the Receiver. |

| Item | Description |
|--------------------------|--|
| Reboot | Check the box and click Reboot to reset the Receiver's settings back to the factory default. All custom settings (but not the login information) will be lost. |
| Receiver Password Change | Check Enable to require a password for access to the Receiver's OSD configuration screen. Enter the Old Password, enter a New Password, and confirm the new password in the Confirm Password box. |

After entering the information, click **Save**.

Transmitter Configuration

When you select the *Transmitter* radio button and click **Configure** to login, the Network tab appears:

The screenshot displays the KX OSD configuration interface. On the left, a navigation menu includes 'Receiver', 'Transmitter' (selected), 'User Preferences', and 'About'. Below the menu is a 'Password' field and a 'Configure' button. The main content area is titled 'Network' and contains the following elements:

- IP Installer:** Three radio buttons: 'Enable' (selected), 'View Only', and 'Disabled'.
- Network Configuration:** Two radio buttons: 'Obtain IP address automatically' (selected) and 'Set IP address manually'.
- Manual IP Configuration:** Three input fields:
 - IP Address: 192.168.0.61
 - Subnet Mask: 255.255.255.0
 - Default Gateway: (empty)
- Save:** A blue button located at the bottom right of the configuration area.

Network

The *Network* tab allows you to configure the Transmitter's IP address settings:

| Item | Description |
|-----------------------|--|
| IP Installer | <p>The IP Installer is an external Windows-based utility for assigning an IP address to the device. Click one of the radio buttons to select Enable, View Only, or Disable for the IP Installer utility. See <i>IP Installer</i>, page 230 for instructions.</p> <p>Note: For security, we strongly recommend that you set this to <i>View Only</i> or <i>Disable</i> after each use.</p> |
| Network Configuration | <p>For dynamic IP address assignment (DHCP), select the Obtain IP address automatically radio button.</p> <p>To specify a fixed <i>IP Address</i>, <i>Subnet Mask</i>, and <i>Default Gateway</i> select the Set IP address manually radio button and fill in the fields with values appropriate for your network.</p> <p>For help configuring network settings with the OSD, see <i>Network Configuration</i>, page 33.</p> |

After entering the information, click **Save**.

Properties

The *Properties* tab allows you to configure the Transmitter's extender settings:

The screenshot shows the 'Properties' tab of a configuration window. It contains the following settings:

- Mode:** Extender, Matrix
- RS232 Settings:**
 - Baud Rate: 9600
 - Data Bits: 8
 - Parity: None
 - Stop Bits: 1
 - Flow Control: None
- Properties:**
 - OS Language: English [US]
 - Port OS: WIN
 - Enable Multicast Video
 - Enable Multicast Audio
 - EDID Mode Selection: Manual (with EDID button)
 - Enable Media:**
 - Video
 - Audio
 - USB
 - RS232
- Manager Address:**
 - Manager IP: 192.168.0.12
 - Manager Port: 9110
- Transmitter Video Setting:**
 - Video Type: 1: DVI-D + 2: DVI-D
 - Video Quality: 5
 - Color Depth: 24 bits
 - Background Refresh: Every 32 frames
 - Bandwidth Limit: Unlimited
- Beeper:** Enable

A 'Save' button is located at the bottom right of the configuration area.

| Item | Description |
|------|--|
| Mode | <p>Select Extender mode for simple one-to-one (Transmitter to Receiver) setups that are managed with the Receiver's OSD menu.</p> <p>Select Matrix mode to manage devices and connections from the KVM over IP Matrix Manager web GUI. This mode is for advanced administration of Transmitter to Receiver connections (see <i>Browser / Telnet Operation</i>, page 75).</p> |

| Item | Description |
|-----------------|--|
| Properties | <p>Port OS: Use the drop-down menu to select the operating system of the computer connected to the Transmitter.</p> <p>OS Language: Use the drop-down menu to select the operating system language of the computer connected to the Transmitter.</p> <p>Enable Multicast Video: Check this box to allow a broadcast of the Transmitter's video signal to be sent out to multiple Receivers.</p> <p>Enable Multicast Audio: Check this box to allow a broadcast of the Transmitter's audio signal to be sent out to multiple Receivers.</p> <p>EDID Mode Selection: EDID contains a display's basic information and is used by the source device to utilize the best resolution across different monitors. When <i>Manual</i> or <i>Remix</i> is selected, the Receiver's OSD will have a button allowing the local EDID setting to be configured for the connection. Select how you want the source device to acquire the display's EDID:</p> <ul style="list-style-type: none"> ◆ Default: EDID is set to the default ATEN configuration. ◆ Auto: Checks the EDID of all connected displays and the ATEN default EDID to use the best common resolution for all displays. ◆ Manual: Manually set the EDID configuration from the Connections Page (see page 53). ◆ Remix: Manually checks the EDID of all connected displays and the ATEN default EDID to use the best common resolution for all displays (see page 53). |
| Enable Media | Select which type of media the Transmitter can stream to Receivers: Video, Audio, USB, and RS232. |
| RS232 Settings | <p>Configure the serial device settings for the Transmitter. The default settings are:</p> <p>Baud Rate: 9600</p> <p>Parity: None</p> <p>Data Bits: 8 bits</p> <p>Stop bits: 1 bit</p> <p>Flow Control: None</p> |
| Manager Address | Set the IP address and Port number of the computer running the KVM over IP Matrix Manager. The default port number is 9110. |

| Item | Description |
|------------------------------|--|
| Transmitter Video Attributes | <p>To set the Transmitter's video settings:</p> <p>Video Type: Select the DVI video connector being used by the display: Digital (DVI-D) or Digital (DVI-I).</p> <p>Color Depth: Select the number of bits to use for the color depth: 24, 16, or 8. This is the number of bits used to describe the color of a single pixel. A bit depth determines the number of colors that can be displayed at one time.</p> <p>Bandwidth Limit: Select the maximum bandwidth that the Transmitter can use to transmit video over the network. A lower bandwidth setting transmits lower quality video; a higher bandwidth setting sends higher quality video but this can affect network speed.</p> <p>Video Quality: Select the video quality to use. 5 is the highest video quality, and 1 is the lowest video quality. Options are: 1~5.</p> <p>Background Refresh: Sets how often the Transmitter refreshes the background image on the connected display. Options are to refresh every 256,128, 64, 32,16, or 0 frames.</p> |
| Beeper | <p>Check this box to allow the device to beep every time a configuration change is made.</p> |
| Occupy Timeout | <p>Set a time threshold for devices whose Access Mode has been set to Occupy (see <i>Access Type</i>, page 106). If there is no activity from the Receiver occupying the port for the amount of time set here, the Receiver is timed out and the port is released. The first Receiver to send keyboard or mouse input after the port has been released gets to occupy the port. Input a value from 1 to 240 seconds.</p> |

After entering the information, click **Save**.

System

The *System* tab allows you to configure the Transmitter's general settings:

| Item | Description |
|-----------------------------|---|
| Device Information | Enter the Name and Description of the Transmitter. It also displays the <i>IP Address</i> , <i>MAC Address</i> , <i>F/W Version</i> , and <i>Serial Number</i> of the Transmitter. |
| Reboot | Check the box and click Reboot to reset the Transmitter's settings back to the factory default. All custom settings (but not the login information) will be lost. |
| Transmitter Password Change | Check Enable to require a password for access to the Transmitter's OSD configuration screen. Enter the Old Password, enter a New Password, and confirm the new password in the Confirm Password box. |

After entering the information, click **Save**.

User Preferences

When you select the *User Preferences* radio button and click **Configure** to login, the configuration screen appears:

| Item | Description |
|----------------------|---|
| User Password Change | This section allows you to change the OSD password: <ol style="list-style-type: none"> 1. Key in the old password in the Old password field. 2. Key in the new password in the New password field. 3. Key in the new password again in the Confirm password field. |
| OSD Language | Click the drop-down menu to select the language you want to use for OSD sessions. Choices are: English, Chinese (Simplified), Chinese (Traditional), Japanese, Korean, Dutch, French, Spanish, Portuguese, and Russian. |
| OSD Hotkey | Select the hotkey combination to invoke the OSD screen. |
| Logout Timeout | If there is no user input for the amount of time set with this function, the user is automatically logged out of the OSD. A login is necessary before the OSD can be accessed again. |
| Screen Blanker | Set how many minutes the OSD waits when a session is idle before turning off the display. |

When you have made your choices, Click **Save**.

OSD Matrix Mode

If you set the system to Matrix mode (in Properties), you will see the *System Login* screen when you enter the invoke the OSD, which provides access to the *Connection Page* by entering a username and password:

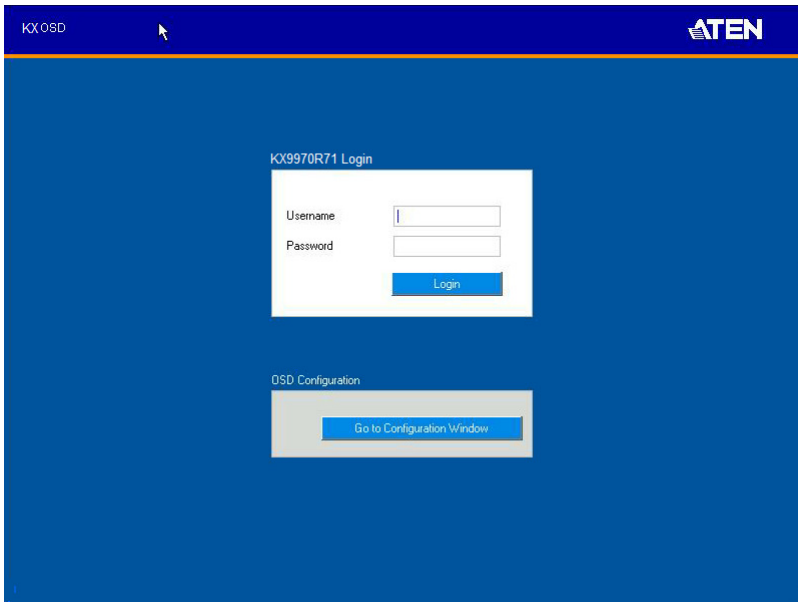

Note: 4. If the Receiver does not require a login, click *Login to system* (see *Login Required*, under *Basic*, page 99). For information about Extender and Desktop/Matrix modes, see *Mode*, page 42.

After you login the *Connection Page* appears, as shown on the next page.

| No. | Item | Description |
|-----|----------------|--|
| 4 | Connect | <p>To connect the Receiver to a Channel, click the access type:</p> <p>Exclusive: The first Receiver to access the Channel has exclusive control over the Channel. No other Receivers can view the Channel. The Timeout function does not apply to this setting.</p> <p>Occupy: The first Receiver to access the Channel has control over the Channel. However, additional Receivers may view the Channel's video display. If the Receiver controlling the Channel is inactive for longer than the time set in the Timeout box, control is transferred to the first Receiver to move the mouse or strike the keyboard.</p> <p>Share: Can simultaneously share control over the Channel. Input from the Receivers is placed in a queue and executed chronologically.</p> <p>View Only: Receiver connects with view only access to the Channels video display.</p> |
| 5 | Next Arrow | Use these two buttons to navigate to the next page or to the end of the list if there are more Channels available than can be seen on the page. |
| 6 | Previous Arrow | Use these two buttons to navigate to the previous page or to the beginning of the list if there are more Channels available than can be seen on the page. |
| 7 | Favorites | <p>Click Favorites to list only the Channels marked as favorites. Channels marked as favorites appear with a heart icon.</p> <p>To add/remove a Favorite, select a Channel and then right click with the mouse to select Add to Favorite or Remove from Favorite.</p> <p>Note: A maximum of 50 channels can be marked as <i>Favorites</i>.</p> |
| 8 | Array Mode | Click to view the Channel connections with a video preview of each source. The list will be shown in groups of six at a time. The Array Mode is discussed on page 56. |
| 9 | List Mode | This option appears after selecting <i>Array</i> mode. Click to view the Channel connections in a list that can be sorted by name or with favorites listed first. Click the Channel Name heading to change the sort. |

| No. | Item | Description |
|-----|----------------------------|---|
| 10 | EDID Mode | <p>When a Transmitter's EDID is configured, depending on its setting, different buttons will or won't appear to configure the Receiver's EDID for the connection. The following rules apply to the Receiver's OSD according to the Transmitter's EDID setting:</p> <ul style="list-style-type: none">◆ Under Default or Auto EDID mode, no EDID button appears as there is nothing to configure.◆ Under Manual or Remix EDID mode, the EDID button appears allowing you to select <i>Manual EDID</i> or <i>Remix EDID</i>. <p>Click Manual or Remix to adjust the EDID setting locally.</p> <p>To set the Transmitter's EDID Mode, see <i>Properties</i>, page 48.</p> |
| 11 | Logout | Click this button to log out of the Connection Page. |
| 12 | Go to Configuration Window | Click this button to return to the main OSD screen. |

Array Mode

Note that Array Mode is not supported by slim KVM over IP Receivers.

In *Array Mode* the screen is divided into a grid of panels, with each panel showing the video display of a particular Channel. Right-click a panel and select a mode to connect: **E**: Exclusive, **O**: Occupy, **S**: Share, **V**: View Only, **X**: Exit. While the mouse cursor hovers over a panel displaying video, if audio is being sent from that Transmitter, it can be heard at the Receiver.

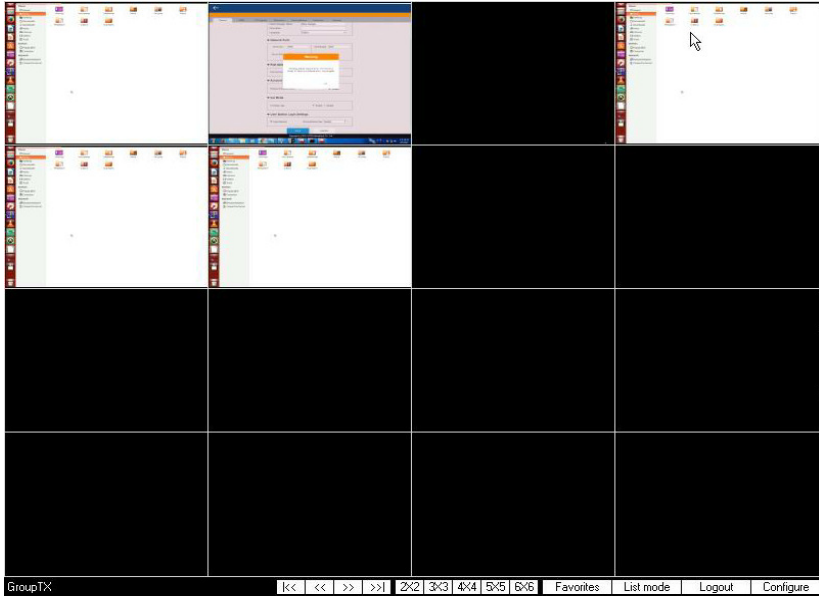

| No. | Item | Description |
|-----|----------------|---|
| 1 | Next Arrow | Use these two buttons to navigate to the next page or to the end of the list if there are more Channels available than can be seen on the page. |
| 2 | Previous Arrow | Use these two buttons to navigate to the previous page or to the beginning of the list if there are more Channels available than can be seen on the page. |
| 3 | Grid Selection | Select a range for how many Channels you want to display. Options are: 2x2, 3x3, 4x4, 5x5, and 6x6. |

| No. | Item | Description |
|-----|-----------|---|
| 4 | Favorites | <p>Click Favorites to list only the Channels marked as favorites. Click All to list all Channels.</p> <p>To add/remove a Favorite, go to List Mode, select a Channel and then right click with the mouse to select Add to Favorite or Remove from Favorite.</p> <p>Note: A maximum of 50 channels can be marked as <i>Favorites</i>.</p> |
| 5 | List Mode | <p>Click to view the Channel connections in a list that can be sorted by name or with favorites listed first. Click the Channel Name heading to change the sort. <i>List Mode</i> is discussed on page 54.</p> |
| 6 | Logout | <p>Click this button to log out of the Connection Page.</p> |
| 10 | Configure | <p>Click this button to return to the main OSD screen.</p> |

Profile Page

Click the *Profile Page* tab and the following screen appears:

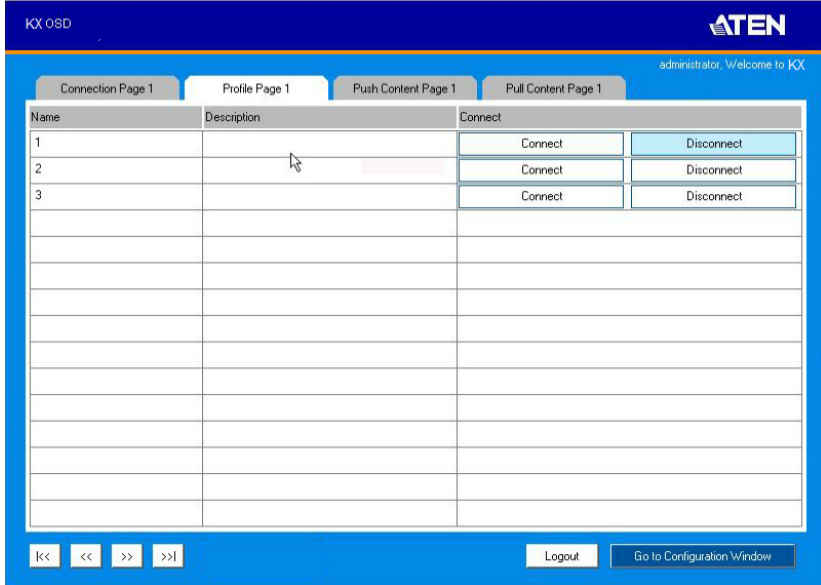

The *Profile Page* components are described in the table below:

| No. | Item | Description |
|-----|----------------------------|---|
| 1 | Name | Lists the Profiles available. Profiles give Receivers access to Channels and allow you to push the connection. |
| 2 | Description | The field provides a description of the Profile that was entered when it was created. |
| 3 | Connect | Click Connect and the Receiver will connect with the settings of that Profile (see <i>Adding a Profile</i> , page 130). |
| 4 | Disconnect | Click Disconnect to end the current Profile connection. |
| 5 | Next Arrow | Use these two buttons to navigate to the next page or to the end of the list if there are more Profiles available than can be seen on the page. |
| 6 | Previous Arrow | Use these two buttons to navigate to the previous page or to the beginning of the list if there are more Profiles available than can be seen on the page. |
| 7 | Logout | Click this button to log out of the Connection Page. |
| 8 | Go to Configuration Window | Click this button to return to the main OSD screen. |

Push Content

Push Content allows you to push the Receiver's computer connection to another Receiver's console, allowing both to access to the computer. Select the *Push Content* tab and the following screen appears:

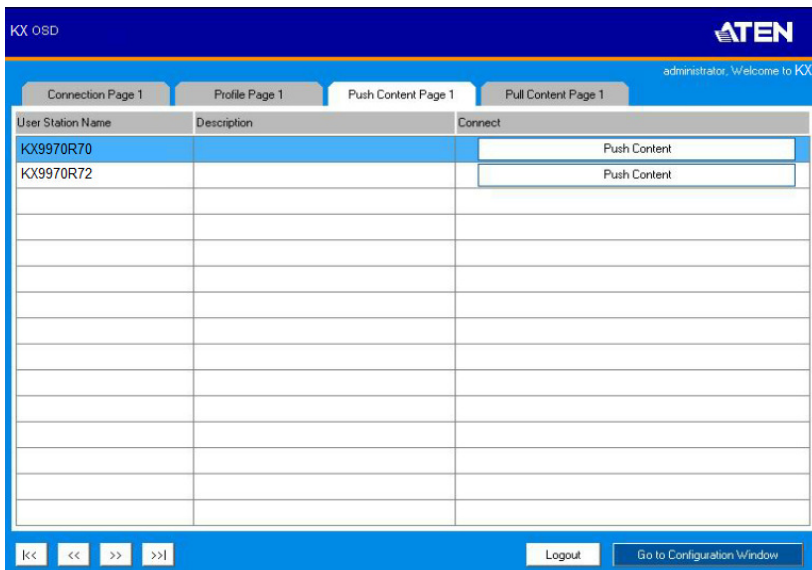

The *Push Content Page* components are described in the table, below:

| No. | Item | Description |
|-----|---------------|---|
| 1 | Receiver Name | Lists the Receivers that can be selected to push the local Receiver's computer connection to. |
| 2 | Description | The field provides a description of the Receiver that was entered when it was created. |
| 3 | Connect | Click Push Content to push the local Receiver's computer connection to the selected Receiver's console. The local Receiver's computer connection will appear on the Receiver that it was pushed to and both will share access to the computer. The access mode selected at the local Receiver will determine how access is shared (see <i>Transmitter Permissions</i> , page 105 for details). |
| 5 | Next Arrow | Use these two buttons to navigate to the next page or to the end of the list if there are more choices available than can be seen on the page. |

| No. | Item | Description |
|-----|----------------------------|--|
| 6 | Previous Arrow | Use these two buttons to navigate to the previous page or to the beginning of the list if there are more choices available than can be seen on the page. |
| 9 | Logout | Click this button to log out of the Connection Page. |
| 10 | Go to Configuration Window | Click this button to return to the main OSD screen. |

Pull Content

Pull Content allows you to pull a Receiver's computer connection to the local Receiver's console, allowing both to access to the computer. Click the *Pull Content* tab and the following screen appears:

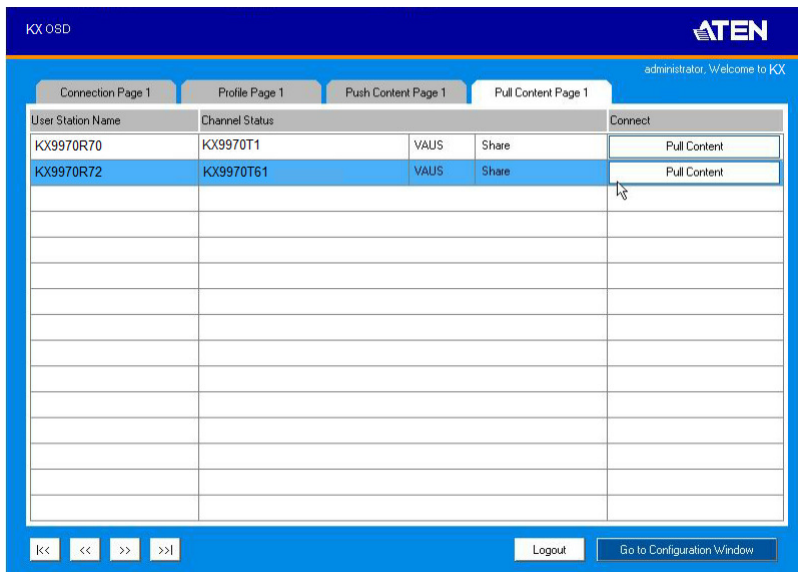

The *Pull Content Page* components are described in the table, below:

| No. | Item | Description |
|-----|----------------------------|--|
| 1 | Receiver Name | Lists the Receiver names currently connected to the Channel listed under <i>Channel Status</i> . |
| 2 | Channel Status | Lists the name, description and access type of each available Channel connection. |
| 3 | Connect | Click Pull Content and the Receiver will pull the Channel connection to the local console using the access mode displayed under Channel Status. |
| 5 | Next Arrow | Use these two buttons to navigate to the next page or to the end of the list if there are more choices available than can be seen on the page. |
| 6 | Previous Arrow | Use these two buttons to navigate to the previous page or to the beginning of the list if there are more choices available than can be seen on the page. |
| 9 | Logout | Click this button to log out of the Connection Page. |
| 10 | Go to Configuration Window | Click this button to return to the main OSD screen. |

This Page Intentionally Left Blank

Chapter 4

Software Installation

Overview

The *CCKM KVM over IP Matrix Manager* is a browser based GUI that provides management of KX Series devices over a network. You can download the KVM over IP Matrix Manager for free and manage up to 8 KX devices, or purchase a license for the KVM over IP Matrix Manager. To purchase a license, contact your local authorized ATEN dealer. To download the free KVM over IP Matrix Manager, use the instructions below.

Note: Please make sure the primary CCKM, redundant server, and all connected KVM over IP Extenders are all installed in a same network segment. If they are not installed in the same network segment, please make sure the primary, redundant server, and all connected KVM over IP Extenders are able to communicate to avoid communication barrier between the servers and devices.

Download

To download the KVM over IP Matrix Manager, do the following:

1. Visit our website and click **Support Center** → **ATEN Support Center**.



2. Under *Account*, click **Create New** or **Log In**.

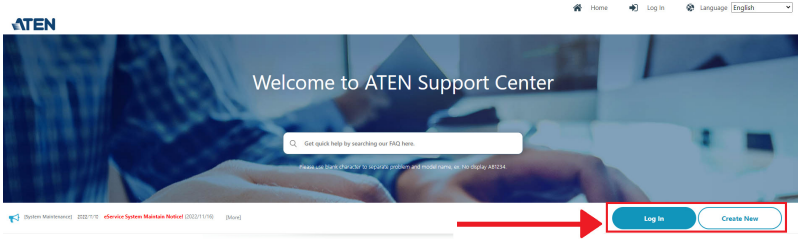

Technical Support

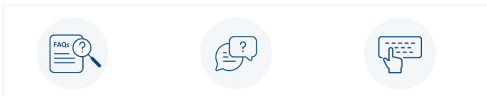

3. After logging in, click **Product Registration** to register the KX device(s) you have purchased.

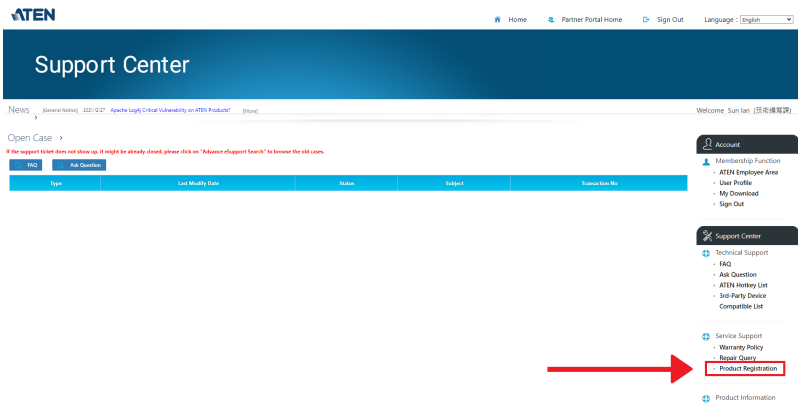

4. After you have registered the KX device(s), click **Trial Software Download**.

The screenshot shows the ATEN Support Center interface. At the top, there are navigation links for Home, Partner Portal Home, Sign Out, and Language (English). The main header is 'Support Center'. Below this, there's a 'Product Registration' section with a 'Insert' button and a message: 'Please press "Insert" button to start it'. A red arrow points from this message to a 'Full Software Download' button. Below the message is a table with columns: Serial Number, Model, Date of Purchase, Inventory / Shipping Document, and Product Recovery Start Date. The table contains one row with the following data:

| Serial Number | Model | Date of Purchase | Inventory / Shipping Document | Product Recovery Start Date | Action |
|---------------|--------|------------------|-------------------------------|-----------------------------|--------|
| 13356758 | KM8700 | 2020/1/14 | | | |

Below the table, there is a link: 'If you need to change product registration data, please [Contact Us](#)'. On the right side, there are navigation menus for 'Account' (Membership Function, ATEN Employee Area, User Profile, My Download, Sign Out) and 'Support Center' (Technical Support, FAQ, Ask Question, ATEN Hotkey List, Self-Healing Center, Compatible List; Service Support, Warranty Policy, Repeat Query, Product Registration; Product Information).

Note: The downloaded version of the KVM over IP Matrix Manager includes full functions and can configure up to 8 KX Series devices. If you would like to configure more KX Series devices, please contact your ATEN reseller to purchase a license and upgrade the license of your software, see page 70.

5. Click the software version you would like to download, then click **Save**.

The screenshot shows the 'My Download' section with two tabs: 'FAQ Attachment Download' and 'Trial Software Download'. The 'Trial Software Download' tab is active, showing a table with columns: File Name, Web Site, and File Download. The table contains two rows:

| File Name | Web Site | File Download |
|--|--|---------------|
| KVM over IP Matrix Manager V2.2.218 (Linux version) CCKM_X.X.XX.XX-64bit-2020-05-26 | CCKM_X.X.XX.XX-64bit-2020-05-26 KX8700/KX8710/KX8720/6840/6900A/6900A1/6900A2/6900A3/6900A4/6900A5/6900A6/6900A7/6900A8/6900A9/6900AA/6900AB/6900AC/6900AD/6900AE/6900AF/6900AG/6900AH/6900AI/6900AJ/6900AK/6900AL/6900AM/6900AN/6900AO/6900AP/6900AQ/6900AR/6900AS/6900AT/6900AU/6900AV/6900AW/6900AX/6900AY/6900AZ/6900BA/6900BB/6900BC/6900BD/6900BE/6900BF/6900BG/6900BH/6900BI/6900BJ/6900BK/6900BL/6900BM/6900BN/6900BO/6900BP/6900BQ/6900BR/6900BS/6900BT/6900BU/6900BV/6900BW/6900BX/6900BY/6900BZ/6900CA/6900CB/6900CC/6900CD/6900CE/6900CF/6900CG/6900CH/6900CI/6900CJ/6900CK/6900CL/6900CM/6900CN/6900CO/6900CP/6900CQ/6900CR/6900CS/6900CT/6900CU/6900CV/6900CW/6900CX/6900CY/6900CZ/6900DA/6900DB/6900DC/6900DD/6900DE/6900DF/6900DG/6900DH/6900DI/6900DJ/6900DK/6900DL/6900DM/6900DN/6900DO/6900DP/6900DQ/6900DR/6900DS/6900DT/6900DU/6900DV/6900DW/6900DX/6900DY/6900DZ/6900EA/6900EB/6900EC/6900ED/6900EE/6900EF/6900EG/6900EH/6900EI/6900EJ/6900EK/6900EL/6900EM/6900EN/6900EO/6900EP/6900EQ/6900ER/6900ES/6900ET/6900EU/6900EV/6900EW/6900EX/6900EY/6900EZ/6900FA/6900FB/6900FC/6900FD/6900FE/6900FF/6900FG/6900FH/6900FI/6900FJ/6900FK/6900FL/6900FM/6900FN/6900FO/6900FP/6900FQ/6900FR/6900FS/6900FT/6900FU/6900FV/6900FW/6900FX/6900FY/6900FZ/6900GA/6900GB/6900GC/6900GD/6900GE/6900GF/6900GG/6900GH/6900GI/6900GJ/6900GK/6900GL/6900GM/6900GN/6900GO/6900GP/6900GQ/6900GR/6900GS/6900GT/6900GU/6900GV/6900GW/6900GX/6900GY/6900GZ/6900HA/6900HB/6900HC/6900HD/6900HE/6900HF/6900HG/6900HH/6900HI/6900HJ/6900HK/6900HL/6900HM/6900HN/6900HO/6900HP/6900HQ/6900HR/6900HS/6900HT/6900HU/6900HV/6900HW/6900HX/6900HY/6900HZ/6900IA/6900IB/6900IC/6900ID/6900IE/6900IF/6900IG/6900IH/6900II/6900IJ/6900IK/6900IL/6900IM/6900IN/6900IO/6900IP/6900IQ/6900IR/6900IS/6900IT/6900IU/6900IV/6900IW/6900IX/6900IY/6900IZ/6900JA/6900JB/6900JC/6900JD/6900JE/6900JF/6900JG/6900JH/6900JI/6900JJ/6900JK/6900JL/6900JM/6900JN/6900JO/6900JP/6900JQ/6900JR/6900JS/6900JT/6900JU/6900JV/6900JW/6900JX/6900JY/6900JZ/6900KA/6900KB/6900KC/6900KD/6900KE/6900KF/6900KG/6900KH/6900KI/6900KJ/6900KK/6900KL/6900KM/6900KN/6900KO/6900KP/6900KQ/6900KR/6900KS/6900KT/6900KU/6900KV/6900KW/6900KX/6900KY/6900KZ/6900LA/6900LB/6900LC/6900LD/6900LE/6900LF/6900LG/6900LH/6900LI/6900LJ/6900LK/6900LL/6900LM/6900LN/6900LO/6900LP/6900LQ/6900LR/6900LS/6900LT/6900LU/6900LV/6900LW/6900LX/6900LY/6900LZ/6900MA/6900MB/6900MC/6900MD/6900ME/6900MF/6900MG/6900MH/6900MI/6900MJ/6900MK/6900ML/6900MM/6900MN/6900MO/6900MP/6900MQ/6900MR/6900MS/6900MT/6900MU/6900MV/6900MW/6900MX/6900MY/6900MZ/6900NA/6900NB/6900NC/6900ND/6900NE/6900NF/6900NG/6900NH/6900NI/6900NJ/6900NK/6900NL/6900NM/6900NO/6900NP/6900NQ/6900NR/6900NS/6900NT/6900NU/6900NV/6900NW/6900NX/6900NY/6900NZ/6900OA/6900OB/6900OC/6900OD/6900OE/6900OF/6900OG/6900OH/6900OI/6900OJ/6900OK/6900OL/6900OM/6900ON/6900OO/6900OP/6900OQ/6900OR/6900OS/6900OT/6900OU/6900OV/6900OW/6900OX/6900OY/6900OZ/6900PA/6900PB/6900PC/6900PD/6900PE/6900PF/6900PG/6900PH/6900PI/6900PJ/6900PK/6900PL/6900PM/6900PN/6900PO/6900PP/6900PQ/6900PR/6900PS/6900PT/6900PU/6900PV/6900PW/6900PX/6900PY/6900PZ/6900QA/6900QB/6900QC/6900QD/6900QE/6900QF/6900QG/6900QH/6900QI/6900QJ/6900QK/6900QL/6900QM/6900QN/6900QO/6900QP/6900QQ/6900QR/6900QS/6900QT/6900QU/6900QV/6900QW/6900QX/6900QY/6900QZ/6900RA/6900RB/6900RC/6900RD/6900RE/6900RF/6900RG/6900RH/6900RI/6900RJ/6900RK/6900RL/6900RM/6900RN/6900RO/6900RP/6900RQ/6900RR/6900RS/6900RT/6900RU/6900RV/6900RW/6900RX/6900RY/6900RZ/6900SA/6900SB/6900SC/6900SD/6900SE/6900SF/6900SG/6900SH/6900SI/6900SJ/6900SK/6900SL/6900SM/6900SN/6900SO/6900SP/6900SQ/6900SR/6900SS/6900ST/6900SU/6900SV/6900SW/6900SX/6900SY/6900SZ/6900TA/6900TB/6900TC/6900TD/6900TE/6900TF/6900TG/6900TH/6900TI/6900TJ/6900TK/6900TL/6900TM/6900TN/6900TO/6900TP/6900TQ/6900TR/6900TS/6900TT/6900TU/6900TV/6900TW/6900TX/6900TY/6900TZ/6900UA/6900UB/6900UC/6900UD/6900UE/6900UF/6900UG/6900UH/6900UI/6900UJ/6900UK/6900UL/6900UM/6900UN/6900UO/6900UP/6900UQ/6900UR/6900US/6900UT/6900UU/6900UV/6900UW/6900UX/6900UY/6900UZ/6900VA/6900VB/6900VC/6900VD/6900VE/6900VF/6900VG/6900VH/6900VI/6900VJ/6900VK/6900VL/6900VM/6900VN/6900VO/6900VP/6900VQ/6900VR/6900VS/6900VT/6900VU/6900VV/6900VW/6900VX/6900VY/6900VZ/6900WA/6900WB/6900WC/6900WD/6900WE/6900WF/6900WG/6900WH/6900WI/6900WJ/6900WK/6900WL/6900WM/6900WN/6900WO/6900WP/6900WQ/6900WR/6900WS/6900WT/6900WU/6900WV/6900WW/6900WX/6900WY/6900WZ/6900XA/6900XB/6900XC/6900XD/6900XE/6900XF/6900XG/6900XH/6900XI/6900XJ/6900XK/6900XL/6900XM/6900XN/6900XO/6900XP/6900XQ/6900XR/6900XS/6900XT/6900XU/6900XV/6900XW/6900XX/6900XY/6900XZ/6900YA/6900YB/6900YC/6900YD/6900YE/6900YF/6900YG/6900YH/6900YI/6900YJ/6900YK/6900YL/6900YM/6900YN/6900YO/6900YP/6900YQ/6900YR/6900YS/6900YT/6900YU/6900YV/6900YW/6900YX/6900YY/6900YZ/6900ZA/6900ZB/6900ZC/6900ZD/6900ZE/6900ZF/6900ZG/6900ZH/6900ZI/6900ZJ/6900ZK/6900ZL/6900ZM/6900ZN/6900ZO/6900ZP/6900ZQ/6900ZR/6900ZS/6900ZT/6900ZU/6900ZV/6900ZW/6900ZX/6900ZY/6900ZZ | |
| KVM over IP Matrix Manager V2.2.218 (Windows version) CCKM_X.X.XX.XX-64bit-2020-05-26 | CCKM_X.X.XX.XX-64bit-2020-05-26 KX8700/KX8710/KX8720/6840/6900A/6900A1/6900A2/6900A3/6900A4/6900A5/6900A6/6900A7/6900A8/6900A9/6900AA/6900AB/6900AC/6900AD/6900AE/6900AF/6900AG/6900AH/6900AI/6900AJ/6900AK/6900AL/6900AM/6900AN/6900AO/6900AP/6900AQ/6900AR/6900AS/6900AT/6900AU/6900AV/6900AW/6900AX/6900AY/6900AZ/6900BA/6900BB/6900BC/6900BD/6900BE/6900BF/6900BG/6900BH/6900BI/6900BJ/6900BK/6900BL/6900BM/6900BN/6900BO/6900BP/6900BQ/6900BR/6900BS/6900BT/6900BU/6900BV/6900BW/6900BX/6900BY/6900BZ/6900CA/6900CB/6900CC/6900CD/6900CE/6900CF/6900CG/6900CH/6900CI/6900CJ/6900CK/6900CL/6900CM/6900CN/6900CO/6900CP/6900CQ/6900CR/6900CS/6900CT/6900CU/6900CV/6900CW/6900CX/6900CY/6900CZ/6900DA/6900DB/6900DC/6900DD/6900DE/6900DF/6900DG/6900DH/6900DI/6900DJ/6900DK/6900DL/6900DM/6900DN/6900DO/6900DP/6900DQ/6900DR/6900DS/6900DT/6900DU/6900DV/6900DW/6900DX/6900DY/6900DZ/6900EA/6900EB/6900EC/6900ED/6900EE/6900EF/6900EG/6900EH/6900EI/6900EJ/6900EK/6900EL/6900EM/6900EN/6900EO/6900EP/6900EQ/6900ER/6900ES/6900ET/6900EU/6900EV/6900EW/6900EX/6900EY/6900EZ/6900FA/6900FB/6900FC/6900FD/6900FE/6900FF/6900FG/6900FH/6900FI/6900FJ/6900FK/6900FL/6900FM/6900FN/6900FO/6900FP/6900FQ/6900FR/6900FS/6900FT/6900FU/6900FV/6900FW/6900FX/6900FY/6900FZ/6900GA/6900GB/6900GC/6900GD/6900GE/6900GF/6900GG/6900GH/6900GI/6900GJ/6900GK/6900GL/6900GM/6900GN/6900GO/6900GP/6900GQ/6900GR/6900GS/6900GT/6900GU/6900GV/6900GW/6900GX/6900GY/6900GZ/6900HA/6900HB/6900HC/6900HD/6900HE/6900HF/6900HG/6900HH/6900HI/6900HJ/6900HK/6900HL/6900HM/6900HN/6900HO/6900HP/6900HQ/6900HR/6900HS/6900HT/6900HU/6900HV/6900HW/6900HX/6900HY/6900HZ/6900IA/6900IB/6900IC/6900ID/6900IE/6900IF/6900IG/6900IH/6900II/6900IJ/6900IK/6900IL/6900IM/6900IN/6900IO/6900IP/6900IQ/6900IR/6900IS/6900IT/6900IU/6900IV/6900IW/6900IX/6900IY/6900IZ/6900JA/6900JB/6900JC/6900JD/6900JE/6900JF/6900JG/6900JH/6900JI/6900JJ/6900JK/6900JL/6900JM/6900JN/6900JO/6900JP/6900JQ/6900JR/6900JS/6900JT/6900JU/6900JV/6900JW/6900JX/6900JY/6900JZ/6900KA/6900KB/6900KC/6900KD/6900KE/6900KF/6900KG/6900KH/6900KI/6900KJ/6900KK/6900KL/6900KM/6900KN/6900KO/6900KP/6900KQ/6900KR/6900KS/6900KT/6900KU/6900KV/6900KW/6900KX/6900KY/6900KZ/6900LA/6900LB/6900LC/6900LD/6900LE/6900LF/6900LG/6900LH/6900LI/6900LJ/6900LK/6900LM/6900LN/6900LO/6900LP/6900LQ/6900LR/6900LS/6900LT/6900LU/6900LV/6900LW/6900LX/6900LY/6900LZ/6900MA/6900MB/6900MC/6900MD/6900ME/6900MF/6900MG/6900MH/6900MI/6900MJ/6900MK/6900ML/6900MM/6900MN/6900MO/6900MP/6900MQ/6900MR/6900MS/6900MT/6900MU/6900MV/6900MW/6900MX/6900MY/6900MZ/6900NA/6900NB/6900NC/6900ND/6900NE/6900NF/6900NG/6900NH/6900NI/6900NJ/6900NK/6900NL/6900NM/6900NO/6900NP/6900NQ/6900NR/6900NS/6900NT/6900NU/6900NV/6900NW/6900NX/6900NY/6900NZ/6900OA/6900OB/6900OC/6900OD/6900OE/6900OF/6900OG/6900OH/6900OI/6900OJ/6900OK/6900OL/6900OM/6900ON/6900OO/6900OP/6900OQ/6900OR/6900OS/6900OT/6900OU/6900OV/6900OW/6900OX/6900OY/6900OZ/6900PA/6900PB/6900PC/6900PD/6900PE/6900PF/6900PG/6900PH/6900PI/6900PJ/6900PK/6900PL/6900PM/6900PN/6900PO/6900PP/6900PQ/6900PR/6900PS/6900PT/6900PU/6900PV/6900PW/6900PX/6900PY/6900PZ/6900QA/6900QB/6900QC/6900QD/6900QE/6900QF/6900QG/6900QH/6900QI/6900QJ/6900QK/6900QL/6900QM/6900QN/6900QO/6900QP/6900QQ/6900QR/6900QS/6900QT/6900QU/6900QV/6900QW/6900QX/6900QY/6900QZ/6900RA/6900RB/6900RC/6900RD/6900RE/6900RF/6900RG/6900RH/6900RI/6900RJ/6900RK/6900RL/6900RM/6900RN/6900RO/6900RP/6900RQ/6900RR/6900RS/6900RT/6900RU/6900RV/6900RW/6900RX/6900RY/6900RZ/6900SA/6900SB/6900SC/6900SD/6900SE/6900SF/6900SG/6900SH/6900SI/6900SJ/6900SK/6900SL/6900SM/6900SN/6900SO/6900SP/6900SQ/6900SR/6900SS/6900ST/6900SU/6900SV/6900SW/6900SX/6900SY/6900SZ/6900TA/6900TB/6900TC/6900TD/6900TE/6900TF/6900TG/6900TH/6900TI/6900TJ/6900TK/6900TL/6900TM/6900TN/6900TO/6900TP/6900TQ/6900TR/6900TS/6900TT/6900TU/6900TV/6900TW/6900TX/6900TY/6900TZ/6900UA/6900UB/6900UC/6900UD/6900UE/6900UF/6900UG/6900UH/6900UI/6900UJ/6900UK/6900UL/6900UM/6900UN/6900UO/6900UP/6900UQ/6900UR/6900US/6900UT/6900UU/6900UV/6900UW/6900UX/6900UY/6900UZ/6900VA/6900VB/6900VC/6900VD/6900VE/6900VF/6900VG/6900VH/6900VI/6900VJ/6900VK/6900VL/6900VM/6900VN/6900VO/6900VP/6900VQ/6900VR/6900VS/6900VT/6900VU/6900VV/6900VW/6900VX/6900VY/6900VZ/6900WA/6900WB/6900WC/6900WD/6900WE/6900WF/6900WG/6900WH/6900WI/6900WJ/6900WK/6900WL/6900WM/6900WN/6900WO/6900WP/6900WQ/6900WR/6900WS/6900WT/6900WU/6900WV/6900WW/6900WX/6900WY/6900WZ/6900XA/6900XB/6900XC/6900XD/6900XE/6900XF/6900XG/6900XH/6900XI/6900XJ/6900XK/6900XL/6900XM/6900XN/6900XO/6900XP/6900XQ/6900XR/6900XS/6900XT/6900XU/6900XV/6900XW/6900XX/6900XY/6900XZ/6900YA/6900YB/6900YC/6900YD/6900YE/6900YF/6900YG/6900YH/6900YI/6900YJ/6900YK/6900YL/6900YM/6900YN/6900YO/6900YP/6900YQ/6900YR/6900YS/6900YT/6900YU/6900YV/6900YW/6900YX/6900YY/6900YZ/6900ZA/6900ZB/6900ZC/6900ZD/6900ZE/6900ZF/6900ZG/6900ZH/6900ZI/6900ZJ/6900ZK/6900ZL/6900ZM/6900ZN/6900ZO/6900ZP/6900ZQ/6900ZR/6900ZS/6900ZT/6900ZU/6900ZV/6900ZW/6900ZX/6900ZY/6900ZZ | |

6. Unzip the *KeManagerSetup_cckm-x.x.xxx-xx.exe* or *kemanager_setup_CCKM-x.x.xxx-xx.bin* file and double click the *.exe file to start the installation.
7. Follow the instructions on the next page to install the software.

KVM over IP Matrix Manager Install

The following are instructions to install the full version of the KVM over IP Matrix Manager on a primary or secondary computer. For software requirements, see *CCKM Requirements*, page 8.

1. Insert the USB license key into a USB port on your computer. If using a virtual license, skip this step and see *Upgrading License*, page 70, after the installation is complete.

Note: If you have more than 8 KX Series devices in your setup, a USB license key is required to install the KVM over IP Matrix Manager.

2. Double-click the *KXMatrixManagerSetup* file to start the setup. When the *Introduction* screen appears, click **Next**.

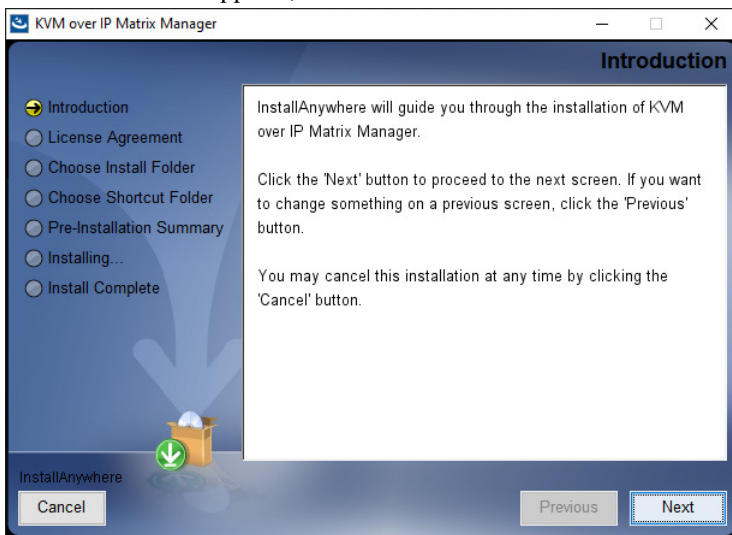

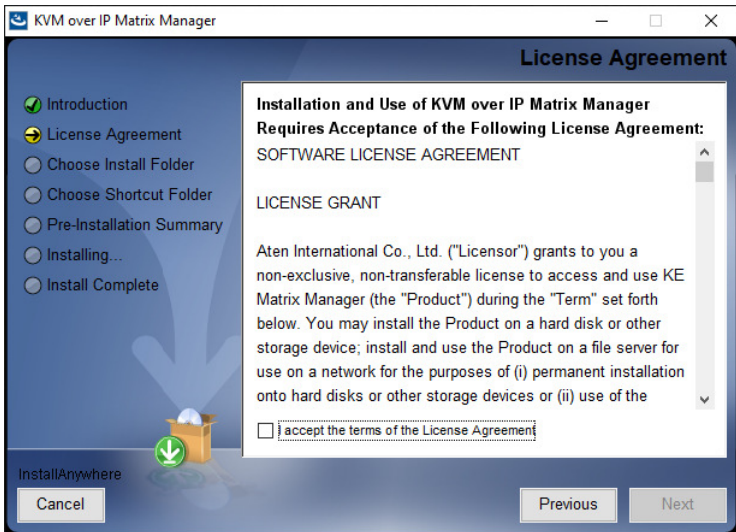
3. The *License Agreement* appears:

If you agree with the License Agreement, select *I accept the terms of the license agreement*, and click **Next**.

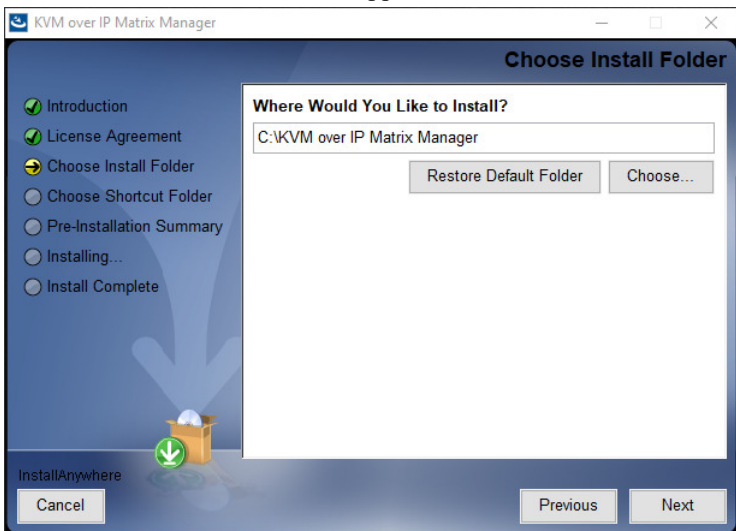
4. The *Choose Install Folder* screen appears:

Select where you would like to install the program, and click **Next**.

5. The *Choose Shortcut Folder* screen appears:

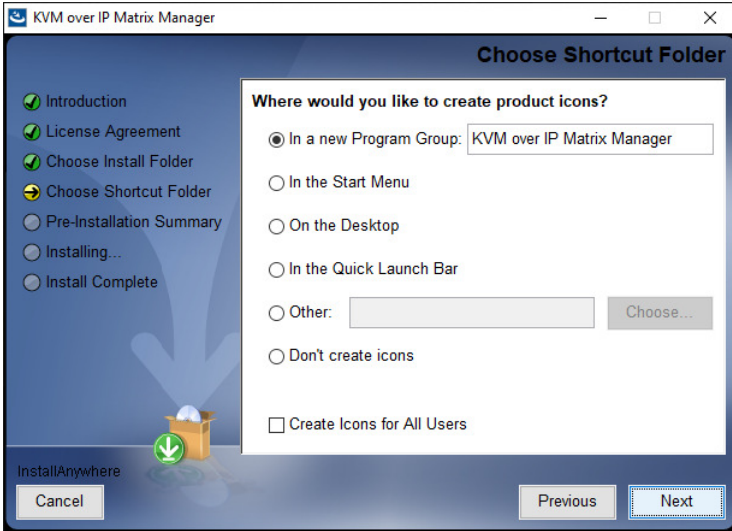

Select where to create shortcuts for the program by selecting the options provided, and click **Next**.

6. The *Pre-Installation Summary* screen appears:

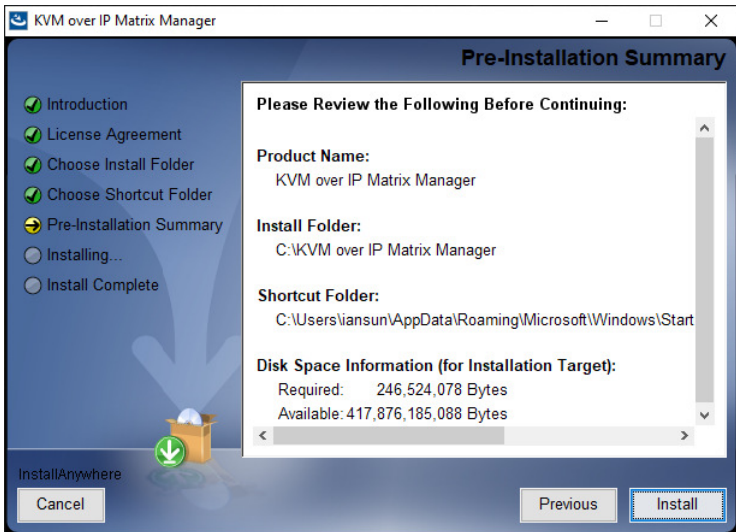

Confirm the settings you've selected. If you want to make a change click **Previous** to go back, or click **Install** to begin the software installation.

7. When the process is done, the *Install Complete* screen appears:

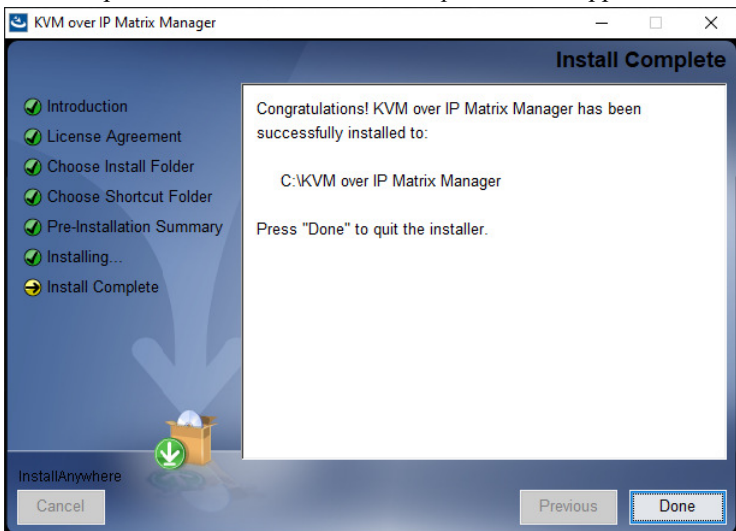

Click **Done**.

Upgrading License

After you purchase a license to upgrade the KVM over IP Matrix Manager, go to the *Settings - General* tab (see page 135), and at the top page, select **Click to Upgrade**, and then browse for and activate your purchased license.

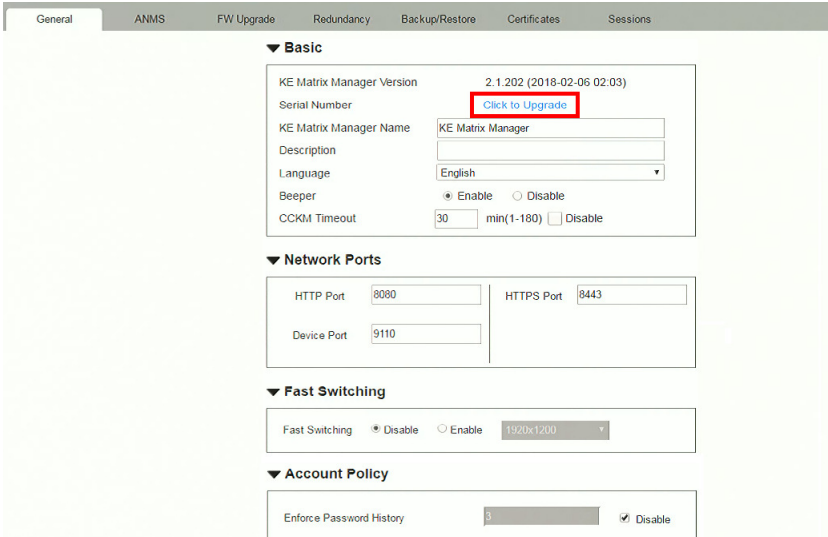

General ANMS FW Upgrade Redundancy Backup/Restore Certificates Sessions

▼ **Basic**

KE Matrix Manager Version 2.1.202 (2018-02-06 02:03)
Serial Number [Click to Upgrade](#)
KE Matrix Manager Name KE Matrix Manager
Description
Language English
Beeper Enable Disable
CCKM Timeout 30 min(1-180) Disable

▼ **Network Ports**

HTTP Port 8080 HTTPS Port 8443
Device Port 9110

▼ **Fast Switching**

Fast Switching Disable Enable 1920x1200

▼ **Account Policy**

Enforce Password History 3 Disable

Linux Installation

The following are instructions to install the full version of the KVM over IP Matrix Manager on a Linux server. For software requirements, see *CCKM Requirements*, page 8.

1. Download the KVM over IP Matrix Manager installation file to the Linux server.
2. Change the properties of the installation file so that its executable by running the command: `chmod a+x filename`
Example: `chmod a+x kemanager_setup.bin`
3. Start the installation with the command:
`sudo sh ./kemanager_setup.bin`
4. When the *Introduction* screen appears, click **Next**:

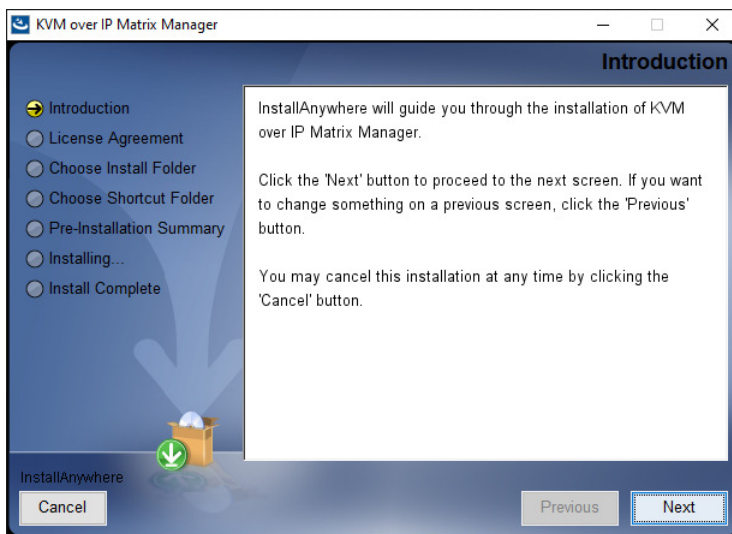

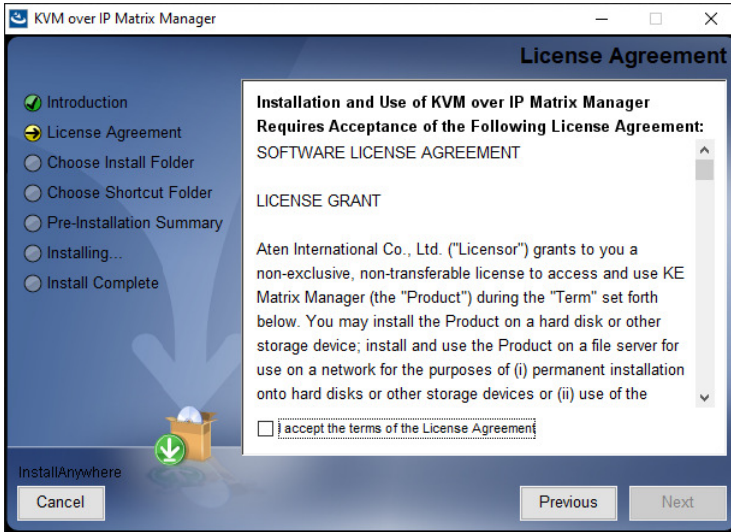
5. The *License Agreement* appears:

If you agree with the License Agreement, select *I accept the terms of the license agreement*, and click **Next**.

6. When the *Choose Install Folder* screen appears, select the location and continue through the installation by clicking **Next**.
7. After the software installs successfully, a directory provides useful links:

```

mitch@mitch-945GCM-S2L:/$ sudo -l
[sudo] password for mitch:
root@mitch-945GCM-S2L:~# ls -al
total 40
drwx----- 7 root root 4096 +- 14 13:42 .
drwxr-xr-x 25 root root 4096 +- 14 10:04 ..
-rw----- 1 root root 65 +- 14 13:42 .bash_history
-rw-r--r-- 1 root root 3106 + 23 2015 .bashrc
drwx----- 2 root root 4096 七 20 04:49 .cache
drwx----- 3 root root 4096 +- 13 16:07 .gnupg
drwxrwxr-x 4 root root 4096 +- 14 13:29 .java
drwxrwxr-x 5 root root 4096 +- 14 13:39 KeManager
drwxrwxr-x 2 root root 4096 +- 14 09:58 .oracle_jre_usage
-rw-r--r-- 1 root root 148 八 17 2015 .profile
root@mitch-945GCM-S2L:~# cd KeManager/
root@mitch-945GCM-S2L:~/KeManager# ls
kemanager          Query_Service      Uninstall_Matrix_Manager
kemanager_installation  Service_Manager
root@mitch-945GCM-S2L:~/KeManager#

```

8. The "Uninstall_Matrix_Manager" can be used to uninstall the software. By default the root folder can be accessed as shown below:

```
sudo -i cd /root cd KeManager sudo ./Uninstall_Matrix_Manager
```

9. To check and stop the KVM over IP Matrix Manager service, use the following commands:

```
cd KeManager sudo ./Query_Service Stop service: sudo ./Stop_Service
```

```

kenanagar@kenanagar:~$ cd /opt/kenanagar/Service_Manager/; sudo ./Query_Service
root@mtch-945GCM-S2L:~/KeManager# sudo ./Query_Service
java version "1.8.0_121"
Java(TM) SE Runtime Environment (build 1.8.0_121-b13)
Java HotSpot(TM) 64-Bit Server VM (build 25.121-b13, mixed mode)
YA35W: ya35w-stable-11.04
OS : Linux/4.4.0-92-generic/amd64
JVM : Oracle Corporation/1.8.0_121
Sep 07, 2017 2:13:51 PM org.apache.commons.vfs2.VfsLog info
INFO: Using "/tmp/vfs_cache" as temporary files store.
Sep 07, 2017 2:13:52 PM org.rzo.yajsw.os.posix.PosixService init
INFO: /etc/init.d/kenanagar-service already exists
Sep 07, 2017 2:13:52 PM org.rzo.yajsw.os.posix.PosixService getPid
INFO: wrapper pid file: /run/wrapper.kenanagar-service.pid
Name : kenanagar-service
Installed : true
Running : false
Interactive : false
Automatic : false
Manual : false
Disabled : false
Paused : false
Unknown : false
Press [Enter] ...
root@mtch-945GCM-S2L:~/KeManager# cd Service_Manager/
root@mtch-945GCM-S2L:~/KeManager/Service_Manager# ls
Install_Service Start_Service Stop_Service Uninstall_Service
root@mtch-945GCM-S2L:~/KeManager/Service_Manager# sudo ./Stop_Service
java version "1.8.0_121"
Java(TM) SE Runtime Environment (build 1.8.0_121-b13)
Java HotSpot(TM) 64-Bit Server VM (build 25.121-b13, mixed mode)
YA35W: ya35w-stable-11.04
OS : Linux/4.4.0-92-generic/amd64
JVM : Oracle Corporation/1.8.0_121
Sep 07, 2017 2:15:01 PM org.apache.commons.vfs2.VfsLog info
INFO: Using "/tmp/vfs_cache" as temporary files store.
Sep 07, 2017 2:15:02 PM org.rzo.yajsw.os.posix.PosixService init
INFO: /etc/init.d/kenanagar-service already exists
***** STOPPING kenanagar-service *****
Sep 07, 2017 2:15:04 PM org.rzo.yajsw.os.posix.PosixService stop
INFO: Stopping kenanagar-service ...
YA35W: ya35w-stable-11.04
OS : Linux/4.4.0-92-generic/amd64
JVM : Oracle Corporation/1.8.0_121
***** STOPPING kenanagar-service *****
Service kenanagar-service stopped

```

10. To check and start the KVM over IP Matrix Manager service, use the following commands:

```
cd KeManager sudo ./Query_Service Start service: sudo ./Start_Service
```

```

root@mtch-945GCM-S2L:~/KeManager/Service_Manager# sudo ./Start_Service
java version "1.8.0_121"
Java(TM) SE Runtime Environment (build 1.8.0_121-b13)
Java HotSpot(TM) 64-Bit Server VM (build 25.121-b13, mixed mode)
YA35W: ya35w-stable-11.04
OS : Linux/4.4.0-92-generic/amd64
JVM : Oracle Corporation/1.8.0_121
Sep 07, 2017 2:17:27 PM org.apache.commons.vfs2.VfsLog info
INFO: Using "/tmp/vfs_cache" as temporary files store.
Sep 07, 2017 2:17:28 PM org.rzo.yajsw.os.posix.PosixService init
INFO: /etc/init.d/kenanagar-service already exists
***** STARTING kenanagar-service *****
Sep 07, 2017 2:17:28 PM org.rzo.yajsw.os.posix.PosixService getPid
INFO: wrapper pid file: /run/wrapper.kenanagar-service.pid
Sep 07, 2017 2:17:33 PM org.rzo.yajsw.os.posix.PosixService start
INFO: Starting kenanagar-service ...
YA35W: ya35w-stable-11.04
OS : Linux/4.4.0-92-generic/amd64
JVM : Oracle Corporation/1.8.0_121
***** STARTING kenanagar-service *****
Service kenanagar-service started
Sep 07, 2017 2:17:33 PM org.rzo.yajsw.os.posix.PosixService getPid
INFO: wrapper pid file: /run/wrapper.kenanagar-service.pid
Sep 07, 2017 2:17:34 PM org.rzo.yajsw.os.posix.PosixService getPid
INFO: wrapper pid file: /run/wrapper.kenanagar-service.pid
Sep 07, 2017 2:17:34 PM org.rzo.yajsw.os.posix.PosixService getPid
INFO: wrapper pid file: /run/wrapper.kenanagar-service.pid
Service kenanagar-service started
root@mtch-945GCM-S2L:~/KeManager/Service_Manager#

```

This Page Intentionally Left Blank

Chapter 5

Browser / Telnet Operation

Overview

The *CCKM KVM over IP Matrix Manager* can be accessed through most standard web browsers and via Telnet. Once users log in and are authenticated, the browser GUI comes up. The first section explains the login procedure and web browser components. The last section provides details for connecting via Telnet.

Logging In

To log into the KVM over IP Matrix Manager, do the following:

1. Open the browser and specify the IP address of the computer installed with the KVM over IP Matrix Manager, in the browser's URL location bar.

Note: If the administrator has configured the HTTP or HTTPS port setting as something other than the default, you must include **http://** or **https://** before the IP address, and specify the port number along with the IP address. For example:

```
https://192.168.1.20:8443
```

Where *8443* is the https port number, or *8080* is the http port number, and a colon is inserted between it and the IP address.

2. If a Security Alert box appears, accept the certificate – it can be trusted (See *Trusted Certificates*, page 231 for details). The Login page appears:

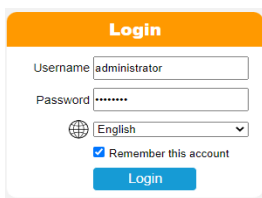

3. Enter the *Username* and *Password* and click **Login**.

Note: Only administrator accounts can be used to log in. By default, the username and password are *administrator* and *password*, respectively.

4. For security purposes, the system will prompt you to change the password immediately.

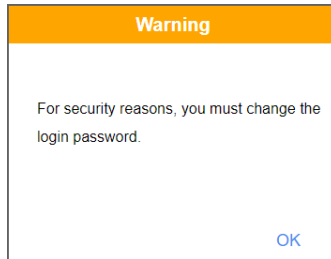

Click **OK** for the password change dialog box.

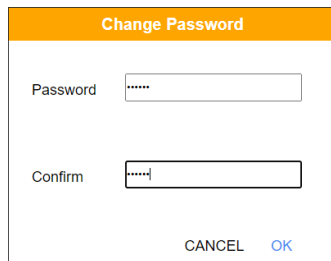

5. Enter the new password and confirm it by entering the password again.
6. Click **OK** to complete the change and the KVM over IP Matrix Manager main page appears. Refer to the next page for more details.

The KVM over IP Matrix Manager Main Page

After you have successfully logged in, the web browser's main page appears:









Web Components

The web components are described in the table below:

| No. | Item | Description |
|-----|---------------------------|--|
| 1 | Install Wizard | This icon helps you locate Transmitters/Receivers on the LAN to add them to the KVM over IP Matrix Manager (see <i>Installation Wizard</i> , page 79). If a device can't be found, check the Network settings in the device's OSD menu (see page 41 & 46). |
| 2 | System Settings | Click this icon to enter the <i>System Setting</i> section where you can configure the KVM over IP Matrix Manager. The Settings are discussed on page 135. |
| 3 | Logout | Click this button to log out of your KVM over IP Matrix Manager web session. |
| 4 | Interactive Display Panel | This is your main work area. Scroll the page up or down to view the various selections. Some items can be clicked to open a settings page, while others provide status information. |
| 5 | Instant Link | Clicking this icon opens the lower bar which allows you to instantly connect KX devices. Instant Link is discussed on page 85. |
| 6 | KE & KX Toggle | Click this button to switch between KE and KX Series device configuration page. |

Interactive Display Panel

The functions associated with each of the icons on the main interactive display panel are explained in the table below:

| Icon | Function |
|---|--|
|  | System Status: System Status provides an overview of the transmitter, receiver, user, profile, and log status. Each heading can be clicked to open the respective settings page. System Status is discussed on page 93. |
|  | Connections: Connections provides a visual display of current transmitter and receiver connections. Connections is discussed on page 165. |
|  | Scheduled Profile: Scheduled Profile provides an overview of connection profiles that are scheduled to run. Scheduled Profile is discussed on page 169. |
|  | Sessions: Sessions provides a list of current user sessions. Sessions is discussed on page 171. |
|  | Refresh: The Refresh button provides a way to update the information currently being displayed on the page. |
|  | To Top: This button appears at the bottom right corner of the Interactive Display Panel and allows you to jump back to the top of the page. |

Installation Wizard

Use the *Install Wizard* to add transmitters, receivers, and/or network switches to the CCKM. The wizard locates devices on the network and walks you through adding them. To add devices, do the following:

1. Connect all transmitters, receivers, and/or network switches to the LAN.
2. On the CCKM main page, click the **Install Wizard** icon (page 77). This dialog box appears.



- ◆ To add transmitters and/or receivers, select **Transmitter or Receiver**, click **Next**, and refer to *Adding Transmitters and Receivers*, page 80.
- ◆ To add network switches, select **Network Switch**, click **Next**, and refer to *Adding Network Switches*, page 83.

Adding Transmitters and Receivers

1. On the installation wizard for transmitters and receivers, select options to locate the devices:

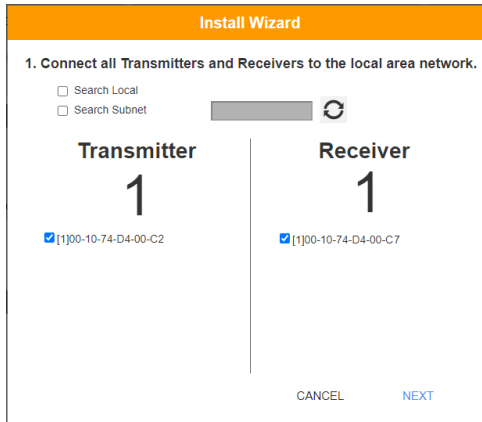

| Item | Description |
|---|---|
| Search Local | Check this box and click the <i>Refresh</i> button to search the local area network for Transmitters/Receivers. |
| Search Subnet | Check this box, enter a subnet IP and then click the <i>Refresh</i> button to search the subnet for Transmitters/Receivers. |
| Transmitter / Receiver | Displays the number of <i>Transmitters</i> and <i>Receivers</i> that have been discovered on the network. Use the check boxes next to the Transmitters/Receivers to select the devices you want to add. |
|  | The <i>Refresh</i> button provides a way to update the information currently being displayed in the install wizard window. |

2. Check the boxes under *Transmitter / Receiver* to select the devices you want to add, then click **Next**.
3. Under *Assign IP Address* select an option to configure the network settings, then click **Next**.

The screenshot shows the 'Install Wizard' interface for step 2, 'Assign IP Address.' The title bar is orange and says 'Install Wizard'. Below the title, the step number '2' is followed by the text 'Assign IP Address.' There are two columns, 'Transmitter' and 'Receiver', each with a large number '1' below it. Under the 'Transmitter' column, there are three radio buttons: 'IP Range', 'DHCP', and 'Use Original IP Setting'. The 'Use Original IP Setting' radio button is selected. Below the radio buttons are two rows of input fields: 'Transmitter' and 'Receiver', each with a text box followed by a tilde '~' and another text box. At the bottom right, there are 'BACK' and 'NEXT' buttons.

| Item | Description |
|-------------------------|--|
| IP Range | Select the <i>IP Range</i> radio button to enter a series of static IP addresses to assign to the <i>Transmitters/Receivers</i> that you are adding. |
| DHCP | Select the <i>DHCP</i> radio button for dynamic IP address assignment. |
| Use Original IP Setting | Select this radio button to use the IP address currently configured on the Transmitter/Receiver. |

4. Use the *Naming Rule* radio button to create a naming convention (*Title + Number*); or *Use Original Name* to use the name currently configured on the Transmitter/Receiver, then click **Next**.

The screenshot shows the 'Install Wizard' interface for step 3, 'Rename devices automatically.' The title bar is orange and says 'Install Wizard'. Below the title, the step number '3' is followed by the text 'Rename devices automatically.' There are three radio buttons: 'Naming Rule', 'Use Original Name', and 'Use Original Name'. The 'Use Original Name' radio button is selected. Below the radio buttons are two rows of input fields: 'Transmitter' and 'Receiver'. Each row has a text box labeled 'Title', followed by '+ Number start from' and another text box. At the bottom right, there are 'BACK' and 'NEXT' buttons.

5. Confirm each Transmitter's *Name*, *IP Address*, *Audio* setting and check the boxes to set *Permissions**, then click **Next** and repeat the process for Receivers.

Install Wizard

4. Confirm Transmitter Information.

Permissions View Only Share Occupy Exclusive Login

| No. | MAC | Name | IP Address | |
|-----|-------------------|---------|------------|---|
| 1 | 00-10-74-D4-00-C2 | KX9970T | 10.3.66.50 | <input type="checkbox"/> <input type="checkbox"/> |
| 1 | 00-10-74-D4-00-C7 | KX9970R | 10.3.66.51 | <input type="checkbox"/> <input type="checkbox"/> |

BACK NEXT

Note: See *Transmitter Permissions*, **page 105**, and *Receiver Permissions*, **page 117** for information about setting permissions.

6. Click **Done**.

Adding Network Switches

1. On the installation wizard for network switches, specify the search parameters to locate the devices:

Switch Wizard
✕

1. Please enter a specific IP address and range to discover devices

IP Range ~

Switch Manufacturer

Search via SNMP v1

Port

Community / User Name

Timeout Milliseconds

Search via SNMP v2c

Search via SNMP v3

[BACK](#)
[NEXT](#)

| Item | Description |
|-------------------------------|---|
| IP Range | Specify the IP address range to search for the network switch to be added. |
| Switch Manufacturer | Selects the manufacturer of the network switch to be added. |
| Search via SNMP v1 / v2c / v3 | Select to search via SNMP v1 / v2c / v3 by entering the corresponding <i>Port</i> , <i>Community / Username</i> and <i>Timeout</i> parameters |

2. Check the boxes next to the network switch devices you want to add.

- Optionally modify the *Device Name* of the network switch(es) to be added, then click **Next**.

Switch Wizard✕

2. Add device(s)

| <input checked="" type="checkbox"/> | Device Name | Model | MAC Address | IP Address |
|-------------------------------------|-------------------------|--------|-------------------|------------|
| <input checked="" type="checkbox"/> | ES0152-QA_t1-g111111111 | ES0152 | 00-40-C7-75-EB-3E | 10.0.92.11 |

BACK NEXT

- For optimal working with the KX Matrix System, make sure to enable the related network services and click **Next**.

Switch Wizard✕

3. Enable services for better connection

In order to make sure the switch(es) could work well with KE system.
The following configurations need to be enabled before you start to use.

IGMP Snooping

IGMP Querier

Fast Leaver

Unregistered Multicast

Flow Control

Speed Mode set to Auto

SKIP NEXT

- Click **Done** to finish.



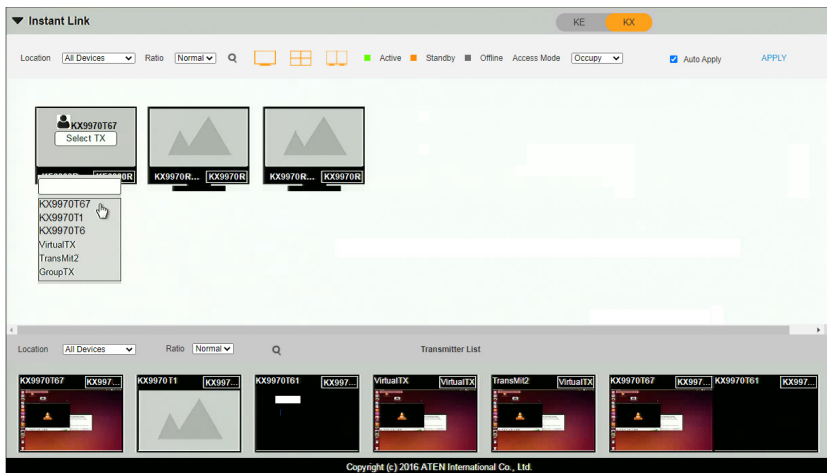

Instant Link

At the bottom of the KVM over IP Matrix Manager Main Page is the *Instant Link* bar. In this section you can quickly connect Receivers to Transmitters.

The top panel provides the **Receiver List**, and the bottom panel provides the **Transmitter List**. To create a connection, click a Receiver in the top panel and use the drop-down menu to select a Transmitter (as shown in the image below); or drag-and-drop Transmitters from the bottom panel to Receivers in the top panel. Configure as many Receiver to Transmitter connections as needed, and then click **Apply**.



| Item | Description |
|------------------|---|
| Instant Link | The Instant Link bar provides access to quickly connect Receivers to Transmitters. Click the bar to open the panel, click again to minimize the panel. The top panel provides a list of all the Receivers discovered on the LAN. Click a Receiver and use the drop-down menu to select a Transmitter. |
| Transmitter List | Click the Transmitter List bar to open the panel. The panel provides a list of all the Transmitters discovered on the LAN. Drag-and-drop Transmitters in the bottom panel to Receivers in the top panel to establish connections. The panel size of the Transmitter List is adjustable by clicking-and-dragging its border. |
| Location | Use the drop-down menu to select a location to filter the Receivers or Transmitters displayed on the page. |

| Item | Description |
|---|---|
| Ratio | Use the drop-down list to adjust the icon size of the Receivers / Transmitters. |
|  | Click and type keywords to filter/search for Receivers / Transmitters. |
|  | Click this icon to show individual Receivers. |
|  | Click this icon to show only video wall Receivers. |
|  | Click this icon to show only Receiver Group Receivers. |
| Access Mode | Click a device and use the drop-down box to set the access mode: <i>Occupy</i> , <i>View Only</i> , or <i>Exclusive</i> . |
| Auto Apply | Checking this box allows you to drag and drop devices and apply the connection immediately without having to click the <i>Apply</i> button. |
| Apply | Click Apply to connect the devices. |
| Cancel | Click Cancel to exit without connecting. |

RS-232 / Telnet

The KX Series can be operated and configured via a remote terminal session using Telnet. This is a useful means for configuring devices when they are first set up and connected to the network.

Telnet

To log into the KX Series device by means of a Telnet session, do the following:

1. On your computer, open a terminal (command line) session.
2. At the prompt, key in the KX device's IP address with port 23 in the following way:

```
telnet [IP address] [port]
```

3. Please press **"T / t"** to start **"TextMenu"** The login screen appears. At the login prompt, provide the Password.

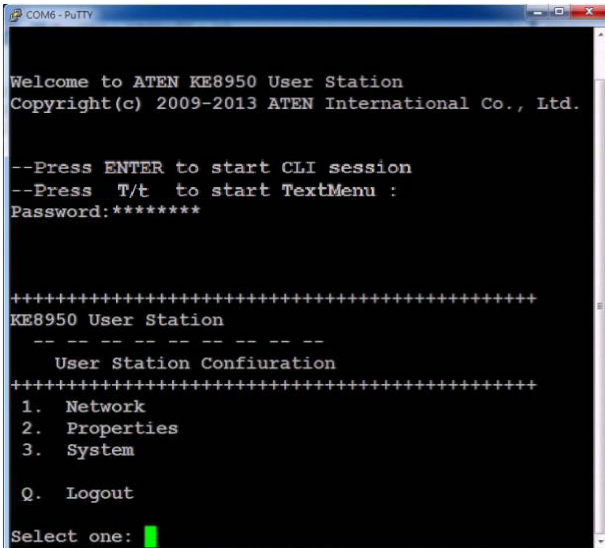

```
COM6 - PUTTY
Welcome to ATEN KE8950 User Station
Copyright(c) 2009-2013 ATEN International Co., Ltd.

--Press ENTER to start CLI session
--Press T/t to start TextMenu :
Password:*****

+++++
KE8950 User Station
  --  --  --  --  --
      User Station Confiuration
+++++
1. Network
2. Properties
3. System
Q. Logout
Select one: █
```

Note: The default password for Telnet sessions is *password*.

RS-232

To log into the KX Series device by means of a RS-232 session, do the following:

1. The controller's serial port should be configured the same as the Receiver's default configuration, as shown below:

| | |
|--------------|------|
| Baud Rate | 9600 |
| Data Bits | 8 |
| Parity | None |
| Stop Bits | 1 |
| Flow Control | None |

The Receiver's **Function Switch** should be set to *RS-232 Config* (see page 11). Before executing RS-232 commands across a network you must install the KVM over IP Matrix Manager on a computer and ensure that it is online.

2. Please press "**T / t**" to start "**TextMenu**". The login screen appears. At the login prompt, provide the Password.

```

COM6 - PuTTY
Welcome to ATEN KE8950 User Station
Copyright(c) 2009-2013 ATEN International Co., Ltd.

--Press ENTER to start CLI session
--Press T/t to start TextMenu :
Password:*****

+++++
KE8950 User Station
-----
User Station Configuration
+++++
1. Network
2. Properties
3. System
Q. Logout
Select one: █

```

Note: The default password for Telnet sessions is *password*.

Configuration Menu

Once a Telnet connection to the KX device is established, the device's text-based Configuration Menu comes up, allowing you to select options by entering a number on the following screens:

Main Menu

```
++++++++++++++++++++++++++++++++++++++++++++++++++++++++++++++++++++
```

```
KX9970 Receiver
```

```
-----
```

```
Receiver Configuration
```

```
++++++++++++++++++++++++++++++++++++++++++++++++++++++++++++++++++++
```

```
1. Network
```

```
2. Properties
```

```
3. System
```

```
Q. Logout
```

```
Select one:
```

1. Network

+++++
KX9970 Receiver

Network Settings

- +++++
1. IP Installer [Enabled]
2. DHCP [Disabled]
3. IP Address [172.17.17.34]
4. Subnet Mask [255.255.255.0]
5. Default Gateway [172.17.17.254]

Q. Exit

Select one:

2. Properties

+++++
KX9970 Receiver

Device Properties

- +++++
1. Mode [Matrix]
2. Transmitter Video IP Address [172.17.17.35]
3. Transmitter Audio IP Address [172.17.17.35]
4. Transmitter USB IP Address [172.17.17.35]
5. Transmitter RS232 IP Address [172.17.17.35]
6. UART Configuration
7. Video [Enabled]
8. Audio [Enabled]
9. USB [Enabled]
10. RS232 [Enabled]
11. KVM over IP Matrix Manager IP [172.17.17.33]
12. KVM over IP Matrix Manager Port [9110]
13. Beeper [Enabled]
14. USB Mode [VM]
15. USB Secure Transmit [Disabled]

Q. Exit

Select one:

3. System

+++++

KX9970 Receiver

System Setting

+++++

1. Device Name [KX9970R]

2. Device Description [Receiver1]

Device IP Address: 172.17.17.34

Device MAC Address: 00:10:74:A8:01:23

Device FW Version: V1.1.109

Device Serial Number:

3. Password [Enabled]

4. Change Password

5. System Reboot/Reset to Factory Default

Q. Exit

Select one:

Note: The Reset to Factory Default function resets everything but the login information to the factory default settings. To reset the login information, refer to *Reset All Information* on page 233.

This Page Intentionally Left Blank

Chapter 6

System Status

Overview

The *System Status* panel is found at the top of the **KVM over IP Matrix Manager** main page. This section provides status information about Transmitters, Receivers, Network Switches, Users, Profiles, and Logs. Click on a selection to open a *Settings* page, which are discussed in the sections that follow.

The screenshot shows the KVM over IP Matrix Manager interface. The top navigation bar includes the ATEN logo, the text 'CCKM KVM over IP Matrix Manager', and icons for help, settings, and refresh. Below the navigation bar, a message reads 'administrator>Welcome to the KVM over IP Matrix Manager'. The main content area features a 'System Status' panel with the following data:

| Transmitter | | | | Receiver | | | | Switch | | |
|-------------|---------|---------|-------|----------|---------|---------|-------|--------|---------|-------|
| Active | Standby | Offline | Total | Active | Standby | Offline | Total | Active | Offline | Total |
| 0 | 0 | 14 | 14 | 0 | 0 | 9 | 9 | 2 | 0 | 2 |

| Users | | Profile | | Log | | |
|--------|------|---------|---------------|---------|-------|-------------|
| Online | Idle | Total | Next Schedule | Warning | Error | Information |
| 1 | 8 | 3 | None | 211 | 58 | 446 |

Below the System Status panel, there is a 'Connections' section with 'Tx-RX' and 'Rx-TX' buttons, and a 'Redundancy Status: (Primary) (Working)' indicator. At the bottom, there are 'Receiver' and 'Transmitter' tabs, and an 'Instant Link' section with 'KE' and 'KX' buttons.

System Status

The *System Status* panel contains six sections that provide information and a link to each settings page. Each settings page can be accessed by **Clicking** within the section: Transmitter, Receiver, Switch, Users, Profile, or Log. Each section is explained in the table below and the Settings on the pages that follow.

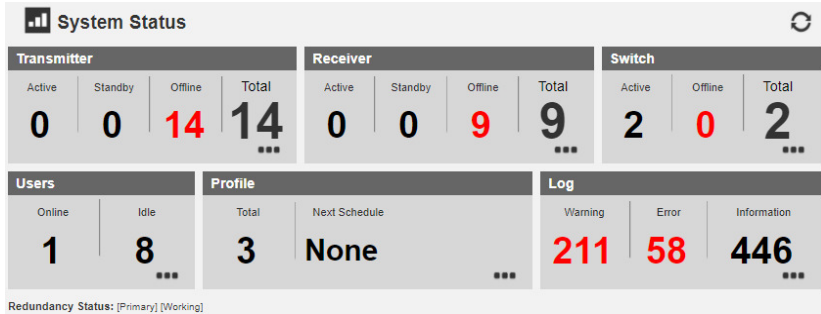

| Item | Description |
|-------------|--|
| Transmitter | <p>This section provides an overview of the Transmitters added to the KVM over IP Matrix Manager:</p> <ul style="list-style-type: none"> ♦ Active: Shows the number of Transmitters that are currently online and connected to a Receiver. ♦ Standby: Shows the number of Transmitters that are online but not connected to a Receiver. ♦ Offline: Shows the number of Transmitters added to the KVM over IP Matrix Manager that are not online. ♦ Total: Displays the total number of Transmitters added to the KVM over IP Matrix Manager. |
| Receiver | <p>This section provides an overview of the Receivers added to the KVM over IP Matrix Manager:</p> <ul style="list-style-type: none"> ♦ Active: Shows the number of Receivers that are currently online and connected to a Transmitter. ♦ Standby: Shows the number of Receivers that are online but not connected to a Transmitter. ♦ Offline: Shows the number of Receivers added to the KVM over IP Matrix Manager that are not online. ♦ Total: Displays the total number of Receivers added to the KVM over IP Matrix Manager. |





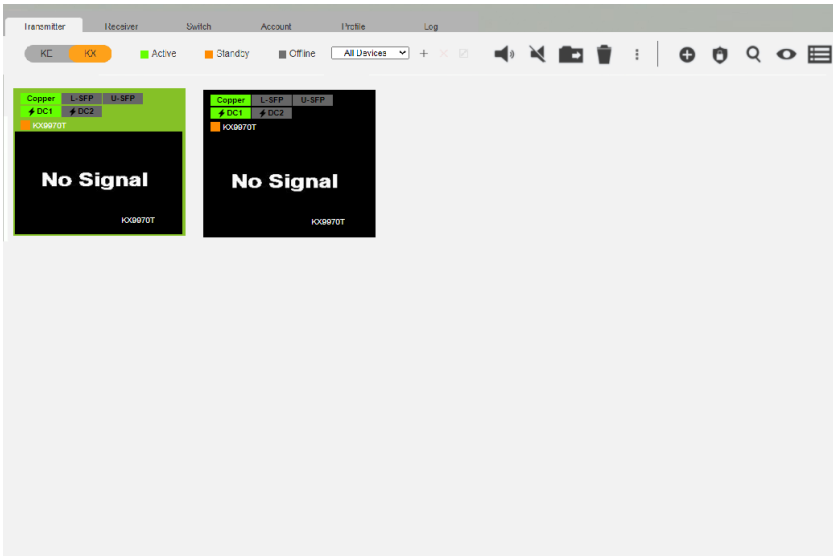

| Item | Description |
|-------------------|---|
| Switch | <p>This section provides an overview of the Network Switches added to the KVM over IP Matrix Manager:</p> <ul style="list-style-type: none"> ◆ Active: Shows the number of Network Switches added to the KVM over IP Matrix Manager that are currently online. ◆ Offline: Shows the number of Network Switches added to the KVM over IP Matrix Manager that are not online. ◆ Total: Displays the total number of Network Switches added to the KVM over IP Matrix Manager. |
| Users | <p>This section provides an overview of users with KVM over IP Matrix Manager sessions:</p> <ul style="list-style-type: none"> ◆ Online: Shows the number of users that are logged into OSD or KVM over IP Matrix Manager web sessions. ◆ Idle: Shows the number of users not logged into OSD or KVM over IP Matrix Manager web sessions. |
| Profile | <p>This section provides an overview of Profile and Profile Schedules:</p> <ul style="list-style-type: none"> ◆ Total: Shows the total number of Profiles available. ◆ Next scheduled to run: Shows the name of the next Profile scheduled to run. ◆ Days later: Shows the number of days until the next Profile is scheduled to run. |
| Log | <p>This section provides an overview of system logs:</p> <ul style="list-style-type: none"> ◆ Warning: Shows the number of warnings logs generated since the event log was cleared. ◆ Error: Shows the number of error logs generated since the event log was cleared. ◆ Information: Shows the number of information logs generated since the log was cleared. |
| Redundancy Status | <p>This section provides information about the Redundancy mode. The first set of brackets shows which server is hosting the KVM over IP Matrix Manager database: [Primary] or [Secondary]. If Redundancy is disabled the first bracket will read: [Standalone]. The second set of brackets show the status:</p> <ul style="list-style-type: none"> ◆ [Working]: The server is actively hosting the KVM over IP Matrix Manager database. ◆ [Standby]: This message appears when database operations are idle. |





Transmitter

Click **Transmitter** in the *System Status* panel to open the settings. On this page you can add, delete and configure *Transmitters* (physical transmitters), *Virtual Transmitters* (multi-source) and *Transmitter Groups* (multi-video source). The KVM over IP Matrix Manager automatically adds Transmitters connected to the local area network with a valid IP address.







The meanings of the icons and headings on the page are straightforward and let you view and configure Transmitters.

- ◆  *Active* refers to a Transmitter connection that is online and in use.
- ◆  *Standby* refers to a Transmitter connection that is online.
- ◆  *Offline* refers to a Transmitter connection that is offline.
- ◆  **All Devices** Use this drop-down menu to filter Transmitters by location. Use Locations to limit the Transmitters seen on the page.
 - ◆  Click to add a new **Location**.
 - ◆  Select a Transmitter and click the **Move to** icon to add devices to a Location.
 - ◆  Select a Location from the drop-down menu and click this icon to delete it.

- ♦  Select a Location and click this icon to change the name.
- ♦  /  Click to turn Beeper & LED Flashing on/off.
- ♦  Click to delete selected Transmitters.
- ♦  Click an option to have selected Transmitters:
 - ♦ **Copy & Paste:** Copy settings from one Transmitter and paste them to another (see *Copy & Paste*, page 101).
 - ♦ **Reboot:** Shut down and restart.
 - ♦ **Reset to Factory:** Reset all setting to the factory default.

Note: The Reset to Factory function resets everything but the login information to the factory default settings. To reset the login information, refer to *Reset All Information* on page 233.

- ♦  Click to *Create Virtual TX* or *Create TX Group* (page 102 & 104).
- ♦  Click to set Transmitter permissions (page 105).
- ♦  Click to search for Transmitters.
- ♦  Click to filter Transmitters shown on the page.
- ♦  Click to switch between *Grid View* and *List View*.

SFP+ Module and Power Detection

- ♦ When an SFP+ module is used on the Transmitter added, the CCKM can automatically detect and display its type, between **Fiber** and **Copper**, as exemplified below.
- ♦ When an power source is used on the Transmitter added, the CCKM can automatically detect which DC power jack is used, between **Power 1** and **Power 2**, as exemplified below.

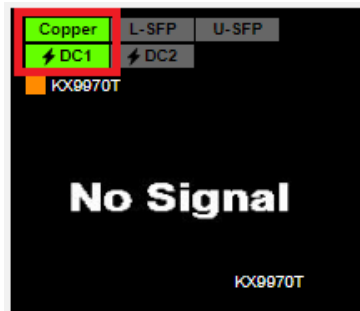

Transmitter Configuration

When the KVM over IP Matrix Manager discovers Transmitters on the network they appear on the *Transmitter* settings page. Double-click a Transmitter to configure its settings.

| Item | Description |
|-------|---|
| Basic | <p>Device Name: Enter a name for the Transmitter.</p> <p>Description: Enter a description for the Transmitter.</p> <p>Location: Use the drop-down menu to select a Location for the device. Locations filter the Transmitters seen on the settings page.</p> <p>Mode: Use the radio button to select how the Transmitter will be installed and managed:</p> <ul style="list-style-type: none"> ◆ Select Extender mode for simple one-to-one (Transmitter to Receiver) setups that are managed at the Receiver's OSD menu. ◆ Select Matrix mode to manage devices and connections over the LAN from the KVM over IP Matrix Manager. This mode is for advanced administration of Transmitter and Receiver connections configured within the KVM over IP Matrix Manager Web GUI. <p>Enable Media: Select which source type the Transmitter can stream: Video, Audio, USB and RS232.</p> <p>Audio Output: Use this option to select the Transmitter's audio source signal: <i>DP</i>, <i>Analog</i>, or <i>Auto</i>. This setting should reflect the audio setting configured on the computer.*</p> |

| Item | Description |
|-------|---|
| Basic | <p>EDID Mode: EDID contains a display's basic information and is used by the source device to utilize the best resolution across different monitors. When <i>Manual</i> or <i>Remix</i> is selected, the Receiver's OSD will have a button allowing the local EDID setting to be configured for the connection (see <i>EDID Mode</i>, page 55). Select how you want the source device to acquire the display's EDID:</p> <ul style="list-style-type: none"> ◆ ATEN Default: EDID is set to the default ATEN configuration. ◆ Auto: Checks the EDID of all connected displays and the ATEN default EDID to use the best common resolution for all displays. ◆ Manual: Manually set the EDID configuration from the Receiver's OSD (see <i>EDID Mode</i>, page 55). ◆ Remix: Manually checks the EDID of all connected displays and the ATEN default EDID to use the best common resolution for all displays (see <i>EDID Mode</i>, page 55). <p>Multicast Video: Select Enable to allow a broadcast of the Transmitter's video signal to be sent to multiple Receivers.</p> <p>Multicast Audio: Select Enable to allow a broadcast of the Transmitter's audio signal to be sent to multiple Receivers.</p> <p>Occupancy Timeout: Set a time threshold for Receivers whose Access Mode has been set to Occupy. If there is no activity from the Receiver occupying the port for the amount of time set here, the Receiver is timed out and the port is released. The first Receiver to send keyboard or mouse input after the port has been released gets to occupy the port. Input a value from 1 to 240 seconds.</p> <p>Port OS: Use the drop-down menu to select the operating system on the computer connected to the Transmitter.</p> <p>OS Language: Use the drop-down menu to select the operating system language on the computer connected to the Transmitter.</p> <p>CCKM IP: Set the IP address and Port number of the computer running the KVM over IP Matrix Manager. The default port number is 9110.</p> <p>IP Installer: The IP Installer is an external Windows-based utility for assigning an IP address to the device. Click a radio button to select Enable, Disable or View Only for the IP Installer utility. See <i>IP Installer</i>, page 230 for instructions.</p> |

| Item | Description |
|---------------------|--|
| Video Settings | <p>These refer to the Transmitter's video settings:</p> <p>Video Type: Select the DVI video connector being used by the display: DP (DisplayPort).</p> <p>Color Depth: Select the number of bits to use for the color depth: 24, 30, or 36 (default setting). This is the number of bits used to describe the color of a single pixel. A bit depth determines the number of colors that can be displayed at one time.</p> <p>Bandwidth Limit: Select the maximum bandwidth that the Transmitter can use to transmit video over the network. A lower bandwidth transmits lower quality video; a higher bandwidth sends higher quality video but this can affect network speed.</p> <p>Video Quality: Select the video quality to use, with the highest to lowest quality being Lossless > Light Compression > Medium Compression > Heavy Compression > Maximum Compression.</p> <p>Background Refresh: Sets how often the Transmitter refreshes the background image on the connected display. Options are to refresh every 256,128, 64, 32,16, or 0 frames.</p> |
| IP Settings | <p>For dynamic IP address assignment, select the DHCP radio button.</p> <p>To specify a fixed IP Address, Subnet Mask, and Default Gateway select the Manual radio button and fill in the fields with values appropriate for your network.</p> <p>For information to configure the network settings locally on the device, see <i>Network Configuration</i>, page 33.</p> |
| Password Protection | <p>Select Enable to require a password to access the Transmitter's OSD configuration screens (see page 41).</p> <p>Enter a <i>Password</i>, and confirm the password in the <i>Confirm</i> box.</p> |
| RS232 Settings | <p>Configure the serial device settings for the Transmitter. The default settings are:</p> <p>Baud Rate: 9600</p> <p>Parity: None</p> <p>Data Bits: 8 bits</p> <p>Stop bits: 1 bit</p> <p>Flow Control: None</p> |

| Item | Description |
|----------------|--|
| Replace Device | <p>Click Replace Device in the top left corner to replace an old Transmitter with a new one.* All settings are copied from the old Transmitter to the new Transmitter. Before using this feature, connect the new Transmitter to the network. After clicking <i>Replace Device</i>, use the drop-down menu to select the new Transmitter where the settings will be applied.</p> <p>Note:</p> <ol style="list-style-type: none"> 1. This option only appears when a Transmitter is offline. 2. This feature can be used for both Receivers and Transmitters. Replacement should be carried out on a similar model. |
| Save | Click Save to save changes to the properties. |
| Cancel | Click Cancel to exit without saving. |

Copy & Paste

Copy & Paste allows you to copy settings from one Transmitter and paste them to another. To copy Transmitter settings to another device, do the following:

1. Select a Physical Transmitter.
2. On the Transmitter menu bar, click **Copy & Paste** (page 97).
3. Check the boxes of the settings you want to copy, and click **Next**.

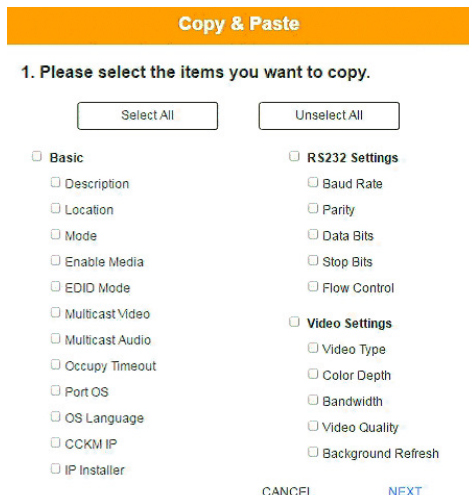

4. Select the Transmitter(s) where you want to apply the settings, and click **Done**.

Copy & Paste

2. Please select the devices you want to paste.

[PREVIOUS](#)
[DONE](#)

Virtual Transmitter

Creating a *Virtual Transmitter* allows you to create one connection that sources media (KVM, audio, USB, serial) from different Transmitters. Virtual Transmitters appear on the *Transmitter* settings page with **Virtual TX** in the top right corner. Simply select an online Transmitter for each media source. Dual Display Transmitters can be added as two separate Virtual Transmitters.

To create a Virtual Transmitter, in *Transmitter* settings click  and then select **Create Virtual TX**.

Create Virtual TX

Name

Description

Location

Video + Keyboard + Mouse

Audio

USB Peripheral

Serial

| Item | Description |
|-------------|---|
| Name | Enter a name for the Virtual Transmitter. |
| Description | Enter a description for the Virtual Transmitter. |
| Location | Use the drop-down menu to select a location for the Virtual Transmitter or leave it as All Devices. See <i>Location</i> , page 96, for details. |

| Item | Description |
|--------------------------------|---|
| Video + Keyboard + Mouse | Use the drop-down menu to select a KVM (keyboard, video, mouse) source for the Virtual Transmitter. |
| Audio | Use the drop-down menu to select an audio source for the Virtual Transmitter. |
| USB Peripheral | Use the drop-down menu to select a USBPeripheral source for the Virtual Transmitter. |
| Serial | Use the drop-down menu to select a serial source for the Virtual Transmitter. |
| Apply | Click Apply to save the changes. |
| Cancel | Click Cancel to exit without saving. |

Transmitter Group

Creating a *Transmitter Group* allows you to create a connection that sources the video from multiple Transmitters to view at across multiple Receiver displays. To use this feature, connect a **Transmitter Group** to a **Receiver Group** (page 113). Transmitter Groups appear at the bottom of the *Transmitter* settings page.

To create a Transmitter Group, in *Transmitter* settings click  and then select **Create Group TX**.

Create TX Group

| | | | | | |
|-------|---------------------------------------|-------------|---------------------------------|----------|--|
| Name | <input type="text" value="TXGroup1"/> | Description | <input type="text"/> | Location | <input type="text" value="Unallocated"/> |
| Audio | <input type="text" value="--"/> | USB | <input type="text" value="--"/> | Serial | <input type="text" value="--"/> |
| | | | | | <input type="checkbox"/> From the same PC video output |

Select a physical transmitter...



CANCEL

SAVE

Fill in the appropriate information and then double-click or drag-and-drop Transmitters to add or remove them in the top panel. The Transmitters in the top panel will be used as the video source for the Receiver Group at the Receiver.

| Item | Description |
|-------------------------------|--|
| Name | Enter a name for the Transmitter Group. |
| Description | Enter a description for the Transmitter Group. |
| Location | Use the drop-down menu to select a location for the Transmitter Group or leave as All Devices. See <i>Location</i> , page 96, for details. |
| From the same PC video output | Enable to indicate that all of the video outputs in this Transmitter Group are from the same multi-screen PC. |
| Save | Click Save to save the changes. |
| Cancel | Click Cancel to exit without saving. |

- Note:** 1. You can create up to 4 transmitter groups.
2. Any transmitter can only be added to 1 transmitter group with the *From the same PC video output* option selected at a time.

Transmitter Permissions

Transmitter Permissions sets the users and groups that can access a **Transmitter**, **Virtual Transmitter**, and **Transmitter Group**.

Select a device under **Transmitter List**, and then next to each user or group click *All*, *View*, *Occupy*, or *Exclusive* to grant them permission to connect to the Transmitter with this access type. A green block denotes that the user has access.

To set Transmitter Permissions, in *Transmitter* settings, click .

Set Transmitter Permissions

Transmitter List

KX9970T

Select all Unselect All
Select all Unselect All
Select all Unselect All
Select all Unselect All
Select all Unselect All
Select all Unselect All

All
 View
 Share
 Occupy
 Exclusive
 Login

| | | | | | |
|------|--|--|--|--|--|
| Ian | | | | | |
| test | | | | | |

■ Group Inherited
 ■ Permission Granted
 No Permission
 Unsupported
 CANCEL APPLY

| Item | Description |
|------------------|--|
| Transmitter List | Lists Transmitters, Virtual Transmitters and Transmitter Groups that can be selected to set permissions. |
| Drop-Down Menu | Use the drop-down menu to select User or Group . After making a selection, the list of users or groups appears. Set permissions by selecting the access type (All, View, Share, Occupy, Exclusive) next to each user or group. |





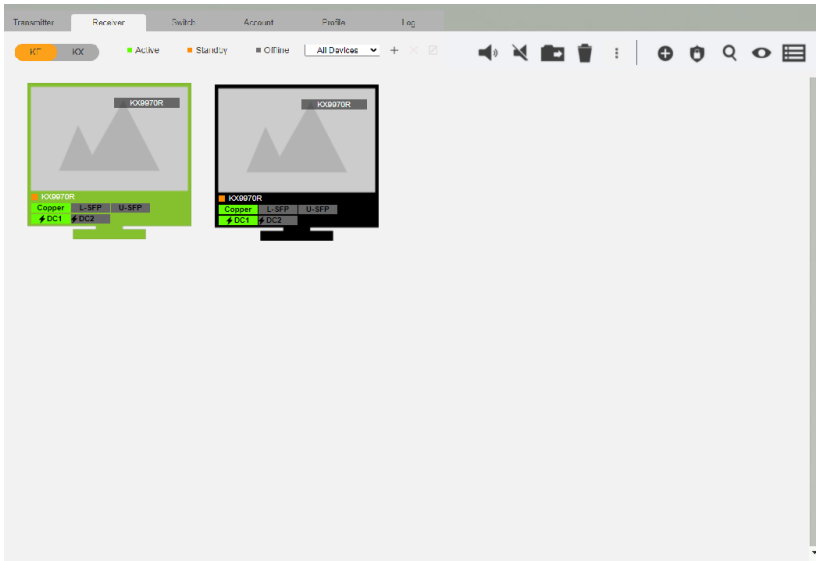

| Item | Description |
|-------------|---|
| Access Type | <p>Select the access you want to grant to a user or group by clicking the boxes under the headings. This defines how the Transmitter can be accessed by a user or group. The access type will appear available for the user in the Receiver's OSD Connections menu. To disable an access type, uncheck a box in the heading.</p> <p>All: Select to grant all access permissions, <i>View</i>, <i>Share</i>, <i>Occupy</i> and <i>Exclusive</i>, to the users or user groups.</p> <p>View: User can only view the remote screen, and cannot perform operations on it.</p> <p>Share: All users accessing the Transmitter can simultaneously share control of the Transmitter. Input from the users is placed in a queue and executed chronologically.</p> <p>Occupy: The first user to access the Transmitter has control. However, additional users may view the Transmitter's video. If the user who controls the Transmitter is inactive for longer than the time set in the Transmitter's Timeout box, control is transferred to the first user to move the mouse or strike the keyboard.</p> |
| Access Type | <p>Exclusive: The first user to access the Transmitter has exclusive control over the Transmitter. No other users can view the Transmitter. The Timeout function does not apply when Transmitters are accessed with this setting.</p> <p>Login: The users are required to use their password to log in for the console video transmission on the connected monitors.</p> |
| Apply | Click Apply to save the changes. |
| Cancel | Click Cancel to exit without saving. |





Receiver

Click **Receiver** in the *System Status* panel to open the settings. The Receiver page allows you to add, delete and configure *Receivers* (physical receivers), *Receiver Groups*, and *Video Walls*. The KVM over IP Matrix Manager automatically adds Receivers connected to the local area network with a valid IP address.







The meanings of the icons and headings on the page are straightforward and let you view and configure Receivers.

- ◆  *Active* refers to a Receiver connection that is online and in use.
- ◆  *Standby* refers to a Receiver connection that is online.
- ◆  *Offline* refers to a Receiver connection that is offline.
- ◆  **All Devices** Use this drop-down menu to filter Receivers by location. Use Locations to limit the Receivers seen on the page.
 - ◆  Click to add a new **Location**.
 - ◆  Select a Receiver and click the **Move to** icon to add devices to a Location.
 - ◆  Select a Location from the drop-down menu and click this icon to delete it.

- ♦  Select a Location and click this icon to change the name.
- ♦  /  Click to turn Beeper & LED Flashing on/off.
- ♦  Click to delete selected Receivers.
- ♦  Click an option to have selected Receivers:
 - ♦ **Copy & Paste:** Copy settings from one Receiver and paste them to another (see *Copy & Paste*, page 112).
 - ♦ **Reboot:** Shut down and restart.
 - ♦ **Reset to Factory:** Reset all setting to the factory default.

Note: The Reset to Factory function resets everything but the login information to the factory default settings. To reset the login information, refer to *Reset All Information* on page 233.

- ♦  Click to *Create Receiver Group* or *Video Wall* (page 113 & 114).
- ♦  Click to set Receiver permissions (page 117).
- ♦  Click to search for Receivers.
- ♦  Click to filter Receivers shown on the page.
- ♦  Click to switch between *Grid View* and *List View*.

SFP+ Module and Power Detection

- ♦ When an SFP+ module is used on the Transmitter added, the CCKM can automatically detect and display its type, between **Fiber** and **Copper**, as exemplified below.
- ♦ When a power source is used on the Transmitter added, the CCKM can automatically detect which DC power jack is used, between **Power 1** and **Power 2**, as exemplified below.

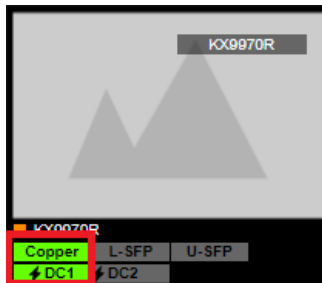

Receiver Configuration

When the KVM over IP Matrix Manager discovers Receivers on the network they appear on the *Receiver* settings page. Double-click a Transmitter to configure its settings.

Receiver Configuration

Basic

Device Name:

Description:

Location:

Mode: Extender Matrix

Enable Media: Video Audio USB RS232

Audio Output: DP Analog Both

CCKM IP:

IP Installer: Enable Disable View Only

Extender Properties

Transmitter Video IP:

Transmitter Audio IP:

Transmitter USB IP:

Transmitter RS232 IP:

RS232 Settings

Baud Rate:

Parity:

Data Bits:

Stop Bits:

Flow Control:

IP Settings

DHCP

Manual

IP Address:

Subnet Mask:

Default Gateway:

Password Protection

Disable

Enable

Password:

Confirm:

USB Mode

Mode: Virtual Media Generic USB Device

Encryption: Enable

CANCEL SAVE

| Item | Description |
|---------------------|---|
| Basic | <p>Device Name: Enter a name for the Receiver.</p> <p>Description: Enter a description for the Receiver.</p> <p>Location: Use the drop-down menu to select a Location for the device. Locations help organize how you view Receivers on the settings page.</p> <p>Mode: Use the radio button to select how the Receivers will be installed and managed:</p> <ul style="list-style-type: none"> ◆ Select Extender mode for simple one-to-one (Transmitter to Receiver) setups that are managed with the Receiver's OSD menu. ◆ Select Matrix mode to manage devices and connections over the LAN from the KVM over IP Matrix Manager. This mode is for advanced administration of Transmitter and Receiver connections configured within the KVM over IP Matrix Manager Web GUI. <p>Enable Media: Select which source type the Receiver can stream: Video, Audio, USB and RS232.</p> <p>Audio Output: Use this option to independently stream <i>DP</i>, <i>Analog</i>, or <i>Both</i> audio signals to digital or analog audio output devices (speakers) connected to the Receiver.*</p> <p>CKM IP: Set the IP address and Port number of the computer running the KVM over IP Matrix Manager. The default port number is 9110.</p> <p>IP Installer: The IP Installer is an external Windows-based utility for assigning an IP address to the device. Click a radio button to select Enable, Disable or View Only for the IP Installer utility. See <i>IP Installer</i>, page 230 for instructions.</p> |
| RS232 Settings | <p>Configure the serial device settings for the Transmitter. The default settings are:</p> <p>Baud Rate: 9600</p> <p>Parity: None</p> <p>Data Bits: 8 bits</p> <p>Stop bits: 1 bit</p> <p>Flow Control: None</p> |
| Extender Properties | <p>If you selected Extender mode (under Basic) set the Transmitter IP address for the Receiver's Video, Audio, USB, and RS232 source.</p> <p>If you selected Matrix mode (under Basic) the <i>Properties</i> will be grayed out. Use Transmitters, Virtual Transmitters, and Transmitter Groups to configure the connections (see <i>Transmitter</i>, page 96).</p> |

| Item | Description |
|---------------------|--|
| IP Settings | <p>For dynamic IP address assignment, select the DHCP radio button.</p> <p>To specify a fixed IP Address, Subnet Mask, and Default Gateway select the Manual radio button and fill in the fields with values appropriate for your network.</p> <p>For information to configure the network settings locally on the device, see <i>Network Configuration</i>, page 33.</p> |
| Password Protection | <p>Select Enable to require a password to access the Receiver's OSD configuration screen (see page 39).</p> <p>Enter a <i>Password</i>, and confirm the password in the <i>Confirm</i> box.</p> |
| USB Mode | <p>Select the type of USB device you will connect to the USB ports:</p> <p>Virtual Media: Only select this option if you are plugging a USB flash drive into the USB ports. This will give you the highest data transfer speeds but cannot work with other USB devices. When Receivers mount or unmount USB flash drives, the keyboard and mouse operations will experience a brief delay. Each Transmitter and Receiver can respectively support up to 12 and 3 virtual media connections at the same time (including Tx local console USB keyboard and mouse).</p> <p>Generic USB Device: Use this option to plug USB peripherals into the USB ports. In this mode, all Receivers support up to 2 USB connections, and all Transmitters support up to 5 USB connections (including Tx local console USB keyboard and mouse).</p> <p>Encryption: Check this box to encrypt USB disk drives plugged into the USB ports.</p> <p>Note: The Generic USB Device option also allows a keyboard and mouse with special functions to be plugged into the USB ports for console use. Use this only if the special functions of the keyboard or mouse are required but do not work when plugged into the console ports. When the keyboard and mouse are plugged into the USB ports, they will not work within the OSD menus. To work within the OSD menus, the keyboard and mouse must be plugged into the console ports.</p> |
| Replace Device | <p>Click Replace Device in the top left corner to replace an old Receiver with a new one.* All settings are copied from the old Receiver to the new Receiver. Before using this feature, connect the new Receiver to the network. After clicking <i>Replace Device</i>, use the drop-down menu to select the new Receiver where the settings will be applied.</p> <p>Note:</p> <ol style="list-style-type: none"> 1. This option only appears when a Transmitter is offline. 2. This feature can be used for both Receivers and Transmitters. Replacement should be carried out on a similar model. |
| Save | <p>Click Save to save changes to the properties.</p> |

| Item | Description |
|--------|---|
| Cancel | Click Cancel to exit without saving. |

Copy & Paste

Copy & Paste allows you to copy settings from one Receiver and paste them to another. To copy Receiver settings to another device, do the following:

1. Select a Physical Receiver.
2. On the Receiver menu bar, click **Copy & Paste** (page 108).
3. Check the boxes of the settings you want to copy, and click **Next**.

Copy & Paste

1. Please select the items you want to copy.

Select All

Unselect All

Basic

- Description
- Location
- Mode
- Enable Media
- CCKM IP
- IP Installer

USB Mode

- Mode
- Encryption

RS232 Settings

- Baud Rate
- Parity
- Data Bits
- Stop Bits
- Flow Control

Extender Properties

- Transmitter Video IP
- Transmitter Audio IP
- Transmitter USB IP
- Transmitter RS232 IP

CANCEL
NEXT

4. Select the Receiver(s) where you want to apply the settings, and click **Done**.

Copy & Paste

2. Please select the devices you want to paste.

Select All

Unselect All

PREVIOUS
DONE

Receiver Group

Creating a *Receiver Group* allows you to connect the video from multiple transmitters to multiple Receiver displays. To use this feature, connect a **Transmitter Group** (*page 104*) to a **Receiver Group** (see *Instant Link*, *page 85*). Receiver Groups appear at the bottom of the *Receiver* settings page.

To create a Receiver Group, in *Receiver* settings, click  and then select **Create RX Group**.

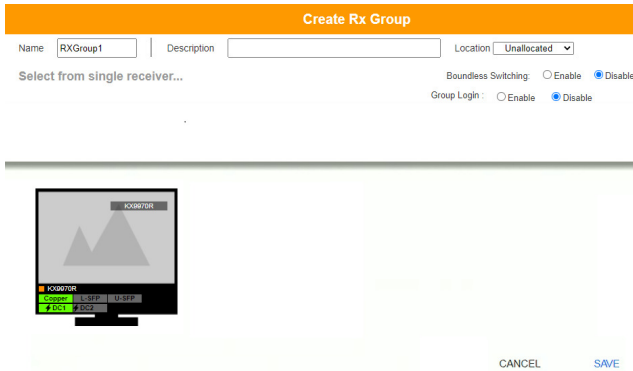

Fill in the appropriate information and then double-click or drag-and-drop Receivers to add or remove them in the top panel. The Receivers in the top panel will be used to view the video from the Transmitter Group. To connect a Transmitter Group to a Receiver Group, see *Instant Link*, *page 85*.

| Item | Description |
|---------------------|---|
| Name | Enter a name for the Receiver Group. |
| Description | Enter a description for the Receiver Group. |
| Location | Use the drop-down menu to select a location for the Receiver Group or leave it as All Devices. See <i>Location</i> , <i>page 96</i> , for details. |
| Boundless Switching | Use the radio button to enable or disable Boundless Switching. See <i>Boundless Switching</i> , <i>page 116</i> for details. |
| Group Login | When enabled, users logging into or out of 1 receiver automatically logs into or out of all other receivers within the Receiver Group, using the same set of credentials. |
| Save | Click Save to save the changes. |
| Cancel | Click Cancel to exit without saving. |

Note: You can create up to 4 receiver groups.

Video Wall

Creating a *Video Wall* allows you to create connections that combine Receiver displays to form a large video wall. Use the options to group multiple Receivers in the video wall. A video wall can contain multiple forms of single displays and grouped displays in various layouts. Video Walls appear listed below Receivers, on the *Receivers* settings page.



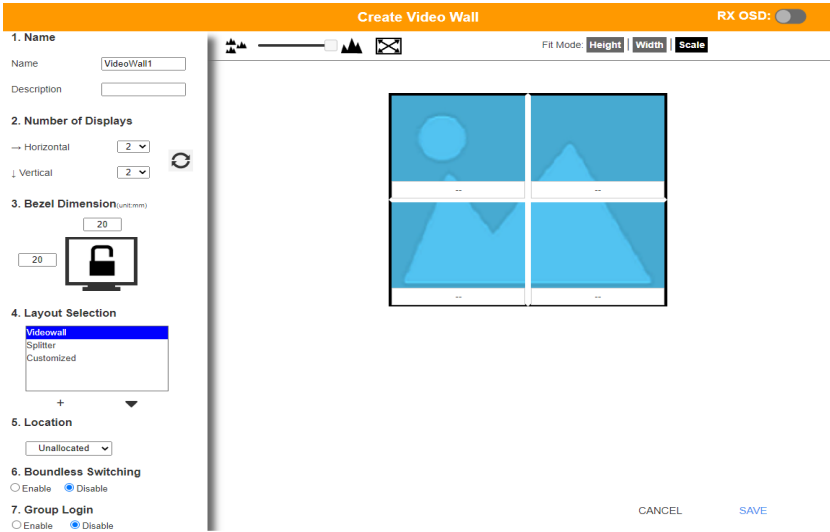

To create a Video Wall, in *Receiver* settings, click  and then select **Create Video Wall**.



Select the number of displays and then group multiple displays to form large screens and/or use single displays for independent screens to create the video wall's layout. Click the bar -- under the display icon to select a Receiver for each display. This configuration should match the actual video wall layout.

| Item | Description |
|--------------------|---|
| Name | Enter a name for the Video Wall. |
| Description | Enter a description for the Video Wall. |
| Number of Displays | Use the Horizontal and Vertical drop-down menus to select the number of displays that make up the video wall (a maximum of 64 are supported). Match this to the physical layout of the displays. Click the refresh icon to update the layout. |

| Item | Description |
|--|---|
| Bezel Dimension | Use the two boxes to increase/decrease the frame size of each active display. |
| Lock / Unlock  | Click the monitor to Lock the (2) bezel settings, so that when one size is changed they all change. Click the monitor to Unlock the (2) bezel settings, so that each size can be set independently. |
| Layout Selection | Click + or X to add or remove additional layouts to the Video Wall. The options listed here will appear in a drop-down menu for the Video Wall, allowing you to quickly choose different layouts from the Receiver settings page. Arrows below the Layout Selection box allow you to move up or down in the list. Three layout templates are available for quick setup. The Videowall and Splitter options can not be changed but allow you to select the Receivers. These three layouts can not be deleted. <ul style="list-style-type: none"> ◆ <i>Video Wall</i> provides a basic full screen layout where one Transmitter connects to multiple Receivers to display the video together as one full screen. ◆ <i>Splitter</i> provides a layout that connects a Transmitter to multiple Receivers that show the same video displayed on separate screens independently. ◆ <i>Customized</i> provides a basic full screen layout that can be configured into groups (see Group below) as desired. Video wall only supports Share, View Only and Occupy access modes. |
| Location | Use the drop-down menu to select a location for the Video Wall or leave it as All Devices. See <i>Location</i> , page 96, for details. |
| Group Login | When enabled, users logging into or out of 1 receiver automatically logs into or out of all other receivers within the Video Wall, using the same set of credentials. |

| Item | Description |
|---|--|
| Boundless Switching | <p>Enable this feature to allow you to switch KVM control between different receivers by moving the mouse cursor across screen boundaries. This option is disabled by default.</p> <p>When Boundless Switching is enabled, make sure to disable the following settings:</p> <ul style="list-style-type: none"> ◆ On the computer, under Control Panel - Mouse Properties - Pointer Options, uncheck Enhance pointer precision. ◆ On the CCKM Main page, click <i>Settings</i> (page 135), then on the <i>General</i> tab scroll down and disable Fast Switching. <p>Note:</p> <ul style="list-style-type: none"> ◆ Dual Display Transmitters can be set up as two independent Virtual Transmitters with Boundless Switching. The placement of the KX Series setup must have DVI-1 as the main display on the left and DVI-2 as a secondary display on the right. Boundless Switching supports both single and dual video outputs from any one computer. ◆ For multi-display PCs, make sure of the following: <ol style="list-style-type: none"> 1. All video outputs are aligned in a row with top alignment and the main screen on the far left. 2. The transmitter's port OS has been properly set, see page 99. 3. Users can optionally group all video outputs from the same PC into a transmitter group. See p. 104. ◆ If the mouse cursor disappears under a Linux operating system, execute this command: <pre>gsettings set org.gnome.setting-daemon.plugins.cursor active false</pre> |
|  | Use the slide bar to zoom in or out for a better view of the Video Wall layout. |
|  | Click this icon to reset the zoom back to full size. |
|  | Select multiple display icons and click the Group button to group the displays into one screen. |
|  | Select a group and click Ungroup to ungroup the displays. |
| Fit Mode | <p>Select how the video wall will be displayed:</p> <p>Height: Fits the video to the height of the display.</p> <p>Width: Fits the video to the width of the display.</p> <p>Scale: Fits the video on the entire display.</p> |

| Item | Description |
|---|--|
|  | Use the RX OSD button to enable/disable showing the Receiver's name and IP address in the top left corner of the connected display. This helps identify which Receiver is connected to the display. |
| Save | Click Save to save the changes. |
| Cancel | Click Cancel to exit without saving. |

Receiver Permissions

Receiver Permissions sets which users and groups can access a Receiver. Select a device under the **Receiver List**, and then click under Operation to grant a user or group permission to access the device. This will allow the user to login to the Receiver's OSD menu to access the Connections tab.

To set Receiver Permissions, in *Receiver* settings, click .

Set Receiver Permissions

Receiver List

KX9970R

Users ▾

ian

test

[Select all](#) [Unselect All](#)

Login

Group Inherited

Permission Granted

No Permission

CANCEL
APPLY

| Item | Description |
|----------------|--|
| Receiver List | Lists the Receivers which can be selected to set permissions. |
| Drop-Down Menu | Use the drop-down menu to select <i>User</i> or <i>Group</i> . After making a selection, the list of users or groups appears. Set permissions by selecting the Operation box next to each user or group. |









| Item | Description |
|-----------|--|
| Operation | Click the Operation box next to each user or group to apply access rights on the selected device. This gives users and groups permission to log in to the Receiver's OSD. If a user inherits its permissions from a group, the box will be Blue. To disable access rights for all users, uncheck the box in the heading. |
| Apply | Click Apply to save the changes. |
| Cancel | Click Cancel to exit without saving. |

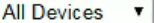

Switch

Click **Switch** in the *System Status* panel to open the settings. On this page you can edit and delete *Network Switches* added to the CCKM (for adding switches, see *Adding Network Switches*, page 83).



The meanings of the icons and headings on the page are straightforward and let you view and configure Network Switches.

- ◆  *Active* refers to a Network Switch connection that is online.
- ◆  *Offline* refers to a Network Switch connection that is offline.
- ◆  Use this drop-down menu to filter Network Switches by location. Use Locations to limit the Switches seen on the page.
 - ◆  Click to add a new **Location**.
 - ◆  Select a Switch and click the **Move to** icon to add devices to a Location.
 - ◆  Select a Location from the drop-down menu and click this icon to delete it.
 - ◆  Select a Location and click this icon to change the name.
- ◆  Click to delete selected Network Switches.

- ◆  Click to search for Network Switches.
- ◆  Click to filter Network Switches shown on the page.
- ◆  Click to switch between *Grid View* and *List View*.

Network Switch Configuration

When Network Switches are added to the KVM over IP Matrix Manager, they appear on the *Switch* settings page. Double-click a Network Switch to configure its settings.

Optionally click **Re-sync parameters** to automatically update the Network Switch by enabling IGMP Snooping, IGMP Querier, Fast Leave, Unregistered Multicast Flooding, Flow Control, and Speed Mode (Auto for Port 1-48 / 10 Gbps FDX for Port 49-52).

Switch Configuration
Re-sync parameters

General
Port Configuration

Basic

Device Name

Description

Location

SNMP Agent Settings

SNMP Version

V1
 V2
 V3

NMS IP / Host Name

Port

Community / User Name

Timeout

Milliseconds

Detect interval

Seconds

CANCEL
SAVE

| Item | Description |
|-------|---|
| Basic | <p>Device Name: Enter a name for the Network Switch.</p> <p>Description: Enter a description for the Network Switch.</p> <p>Location: Use the drop-down menu to select a Location for the device. Locations filter the Network Switches seen on the settings page.</p> |

| Item | Description |
|---------------------|---|
| SNMP Agent Settings | <p>SNMP Version: Select the version of the SNMP used.</p> <p>NMS IP / Host Name: Defines the IP address or the host name of the Network Switch.</p> <p>Port: Defines the port value of the Network Switch.</p> <p>Community / Username: Specifies the SNMP community of the Network Switch.</p> <p>Timeout: Defines timeout threshold in which the Network Switch's connection is reestablished.</p> <p>Detect Interval: Defines the interval in which the connection of the Network Switch is checked for.</p> |

Port Configuration

The *Port Configuration* tab sets the speed mode of each port of the Network Switch.

Switch Configuration
Re-sync parameters

General
Port Configuration

| Port | Speed Mode |
|------|---|
| * | <> |
| 1 | Auto |
| 2 | Auto |
| 3 | Auto |
| 4 | Auto |
| 5 | <div style="border: 1px solid #ccc; padding: 2px;"> <div style="background-color: #e0e0e0; padding: 2px;">Disabled</div> <div style="background-color: #2196f3; color: white; padding: 2px;">Auto</div> <div style="padding: 2px;">10Mbps HDX</div> <div style="padding: 2px;">10Mbps FDX</div> <div style="padding: 2px;">100Mbps HDX</div> <div style="padding: 2px;">100Mbps FDX</div> <div style="padding: 2px;">1Gbps FDX</div> </div> |
| 6 | Auto |
| 7 | Auto |
| 8 | Auto |
| 9 | Auto |
| 10 | Auto |
| 11 | Auto |
| 12 | Auto |

CANCEL
SAVE

Click **Save** to finish.

Account

Click **Users** in the *System Status* panel to open the settings. The *Account* page allows you to add, delete and configure users and groups. Instructions for adding users and groups is provide on page 122.

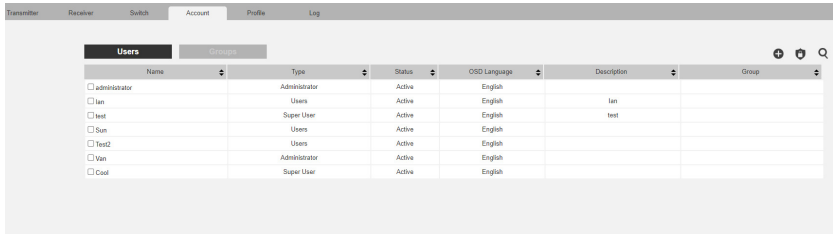

The screenshot shows the 'Account' page with a navigation bar at the top containing 'Transmitter', 'Receiver', 'Switch', 'Account', 'Profile', and 'Log'. Below the navigation bar, there are two tabs: 'Users' (selected) and 'Groups'. The main content area displays a table with the following columns: Name, Type, Status, OSD Language, Description, and Group. Each row has a checkbox on the left. The table contains the following data:

| | Name | Type | Status | OSD Language | Description | Group |
|--------------------------|---------------|---------------|--------|--------------|-------------|-------|
| <input type="checkbox"/> | administrator | Administrator | Active | English | | |
| <input type="checkbox"/> | lan | Users | Active | English | lan | |
| <input type="checkbox"/> | test | Super User | Active | English | test | |
| <input type="checkbox"/> | Sun | Users | Active | English | | |
| <input type="checkbox"/> | Test2 | Users | Active | English | | |
| <input type="checkbox"/> | Van | Administrator | Active | English | | |
| <input type="checkbox"/> | Coal | Super User | Active | English | | |

- ◆ The Users and Group buttons appear at the top of the page.
 - ◆ Depending on the item selected, either Users or Groups are listed on the page.
- ◆ The sort order of the information displayed can be changed by clicking the column headings.
- ◆ Three icons in the right corner are used to add users, groups and set permissions, as explained in the sections that follow.

Users

The KVM over IP Matrix Manager supports three types of accounts, shown in the table below:

| User Type | Role |
|---------------|--|
| Administrator | Access, push/pull and management of the KVM over IP Matrix Manager, including configuration and setting up of devices. Manage Users, Groups, Transmitters, Receivers, Profiles and Video Walls. Configure personal working environments. |
| Super User | Access and push/pull Receivers, Transmitters and Profiles they have been given permission for. |
| User | Access Receivers to connect to Transmitters they have been given permission for. |

Adding Users

To add a user, do the following:

1. Click  on the menu bar.
2. Select **Add New User**. The *Add New User* window opens:

Add New User

Username Local User

Password

Confirm Password

Description

RFID [What is it?](#)

Type Administrator
 Super User
 Users

Status Active
 Disable

OSD Language

OSD Hotkey

Hotkey Mode

Logout Timeout min(1-180) Disable

Screen Blanker min(1-30) Disable

OSD Title Bar Duration sec(3-100) Disable

Welcome Message Enable Username

Group

Enter the required information in the fields provided. A description of each is given in the table below:

| Field | Description |
|------------------|--|
| Username | From 1 to 32 characters are allowed depending on the Account Policy settings. |
| Local User | Check the Local User box if the account is for logging in to the KVM over IP Matrix Manager or a Receiver. Uncheck the Local User box if the account is authenticated with a 3rd party external source, such as RADIUS, LDAP/AD, or TACACS+. See ANMS, page 144 for details. |
| Password | From 6 to 32 characters are allowed depending on the Account Policy settings. |
| Confirm Password | To be sure there is no mistake in the password, you are asked to enter it again. The two entries must match. |
| Description | Additional information about the user that you may wish to include. |
| RFID | The RFID field can be scanned to enter the RFID card number with recommended RFID device. |
| Type | There are three account categories: Administrator, Super User and User. <ul style="list-style-type: none"> ◆ The Administrators have full access to make changes within the KVM over IP Matrix Manager, which includes adding and removing Transmitters, Receivers, accounts, preferences, and configuration settings. ◆ The Super Users have access to the Receiver's OSD menu and can connect Channels and Profiles. ◆ The Users can log in to Receivers to connect channels. |
| Status | Status allows you to control the user's account and access, as follows: <ul style="list-style-type: none"> ◆ <i>Active</i> provides the user with access and permissions as granted. ◆ <i>Disable</i> lets you suspend a user's account without actually deleting it, so that it can be easily reinstated in the future. |
| OSD Language | Click the drop-down menu to select the language you want to use during OSD sessions for this user. Options are: Chinese (Traditional), Simplified Chinese, Japanese, German, Korean, Russian, French, Spanish, and Portuguese. |
| OSD Hotkey | Select the hotkey combination to call the Tool Bar function for this user. The Tool Bar is used when accessing the computer from the Transmitter or Receiver side. |
| Hotkey Mode | Select the hotkey mode that is used to set up with the KX Series device's configuration. All operations begin with invoking the hotkey mode. Options are: [Num Lock] [-] and [Ctrl] [F12]. |

| Field | Description |
|------------------------|---|
| Logout Timeout | If there is no user input for the amount of time set with this function, the user is automatically logged out. A login is necessary before the KVM over IP Matrix Manager can be accessed again. The default is 30 minutes. Check Disable to not set any logout timeout for the users. |
| Screen Blanker | Set how many minutes the device waits when a session is idle before turning off the display. Check Disable to not turn off the display. |
| OSD Title Bar Duration | When the accessing a port, the top left-hand corner will show a title bar displaying the access mode and the device name. Select how long you wish the title bar is to be displayed for, or check Disable to not show any title bar. |
| Welcome Message | If you want the Welcome Message to appear on screen when the user logs into the KVM over IP Matrix Manager, select Enable . If you want the user's Screen Name to appear with the Welcome Message, check the Username check box. |
| Group | Click Select and check a box to add the user to a group. |
| Apply | Click Apply to save the changes. |
| Cancel | Click Cancel to exit without saving. |

3. When your selections have been made click **Apply**.
4. When the *Operation Succeeded* message appears, click **OK**.
5. The new user appears on the main panel.
 - ♦ The columns show the Username; User Level, Status, OSD Language, Description; and Group.

Modifying Users

To modify a user, do the following:

1. In the main panel, double-click the user's name.
2. In the *Edit User* page that comes up, make your changes, then click **Apply**.

Deleting Users

To delete a user, do the following:

1. In the main panel, check the box next to the user's name.
2. Click  .
3. Click **OK**.

Groups

Groups allow administrators to easily and efficiently manage users and devices. Since device access rights apply to anyone who is a member of the group, administrators need only set them once for the group, instead of having to set them for each user individually. Multiple groups can be defined to allow some users access to specific devices, while restricting other users from accessing them. Device permissions are discussed on page 127.

Adding Groups

To create a group, do the following:

1. Click *Group* on the Account page.
2. Click  and then select **Add New Group**. The *Add New Group* window opens:

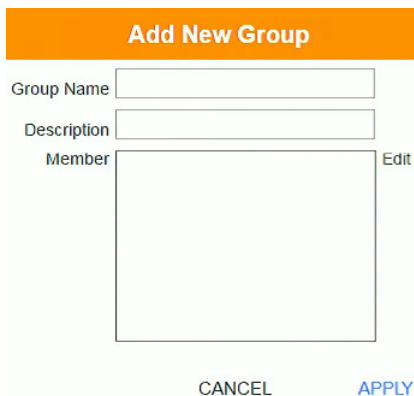

3. Enter the required information in the appropriate fields. A description of each of the fields is given in the table below:

| Field | Description |
|-------------|--|
| Group Name | A maximum of 32 characters is allowed. |
| Description | Additional information about the user that you may wish to include. A maximum of 32 characters is allowed. |
| Member | Lists the users that are currently in the group. To add users, click the Edit button. |

4. At this point you can assign users to the group by clicking **Edit**.
5. When your selections have been made click **Apply**.

6. When the *Operation Succeeded* message appears, click **OK**.
7. The new group appears in the main panel.
 - ♦ The columns show the Group Name, Description and Members that are in the group.

Repeat the above procedure to add additional groups.

Modifying Groups

To modify a group, do the following:

1. In the main panel, double-click the group's name.
2. Make your changes, then click **Apply**.

Deleting Groups

To delete a group, do the following:

1. In the main panel, check the box next to the group's name.
2. Click  .
3. Click **OK**.

Permissions

You can assign Transmitter, Receiver and Profile permissions for users and groups from the *Account* page.

Assigning Device Permissions

To assign permissions for a user or group from the *Account* page, do the following:

1. Click  on the menu bar. The *Set User Permissions* window opens:

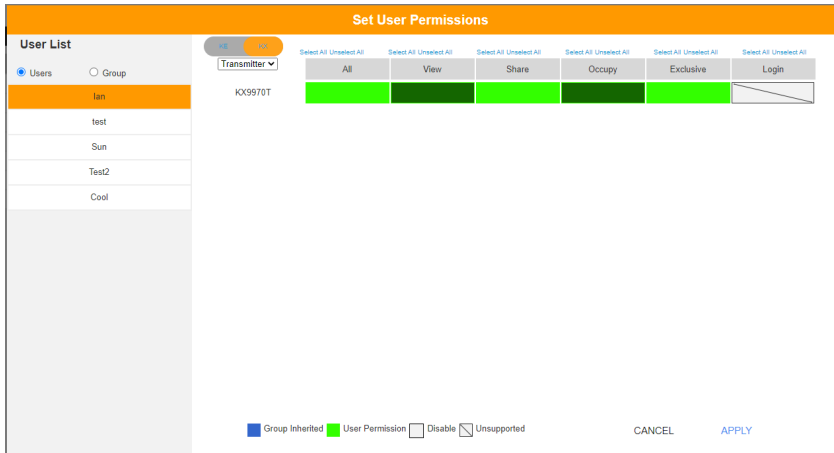

2. To set the permissions, select a user or group, then a device and select the Access Type under each column so that it turns green. Make your permission settings for each user or group on each device according to the information provided below:

| Item | Description |
|----------------|--|
| User List | Use the radio button to view the Users or Group list. Click a user or group to configure their permissions. |
| Drop-Down Menu | Use the drop-down menu to select <i>Transmitter</i> , <i>Receiver</i> or <i>Profile</i> . After making a selection, a list of devices or profiles appears. Set permissions by selecting the access type (All, View, Share, Occupy, Exclusive, and Login) next to the device. |

| Item | Description |
|-------------|--|
| Access Type | <p>Select the access you want to grant to a user or group by clicking under the heading(s) next to each device. This defines how the device can be accessed by the user or group. When granted, the access types (<i>All</i>, <i>View</i>, <i>Occupy</i>, <i>Exclusive</i>) for Transmitters will appear available for the user in the Receiver's OSD Connection page (see page 53).</p> <p>All: Select to grant all access permissions, <i>View</i>, <i>Share</i>, <i>Occupy</i> and <i>Exclusive</i>, to the users or user groups.</p> <p>View: User can only view the remote screen, and cannot perform operations on it.</p> <p>Share: All users accessing the Transmitter can simultaneously share control of the Transmitter. Input from the users is placed in a queue and executed chronologically.</p> <p>Occupy: The first user to access the Transmitter has control. However, additional users may view the Transmitter's video. If the user who controls the Transmitter is inactive for longer than the time set in the Transmitter's Timeout box, control is transferred to the first user to move the mouse or strike the keyboard.</p> <p>Exclusive: The first user to access the Transmitter has exclusive control over the Transmitter. No other users can view the Transmitter. The Timeout function does not apply when Transmitters are accessed with this setting.</p> <p>Login: The users are required to use their password to log in for the console video transmission on the connected monitors.</p> |
| Apply | Click Apply to save the changes. |
| Cancel | Click Cancel to exit without saving. |







3. When you have finished making your choices, click **Apply**.
4. In the confirmation popup that appears, click **OK**.

Profile

Click **Profile** in the *System Status* panel to open the settings. The *Profile* page allows you to create, run and schedule connection profiles. Profiles channel specific Receiver to Transmitter connections and can be instantly connected from the Profile page at anytime. Profiles can be also scheduled to run automatically at specific times.



The meanings of the icons and headings on the page are straightforward and let you view and configure Profiles.

- ◆  Click to connect the selected Profile.
- ◆  Click to disconnect the selected Profile.
- ◆  Click to delete the selected Profile.
- ◆  Click to *Create Profile* or *Create Schedule* (page 130 & 133).
- ◆  Click and enter text to search for a Profile.
- ◆  Check the box next to a **Profile** and click the *Connect* or *Disconnect* icon to start/stop profile connections. Check the box next to a **Schedule** and click the *Enable* or *Disable* icon to enable/disable a schedule.

Adding a Profile



Creating a Profile allows you to quickly connect single or multiple Receiver to Transmitter connections.

To add a Profile, do the following:

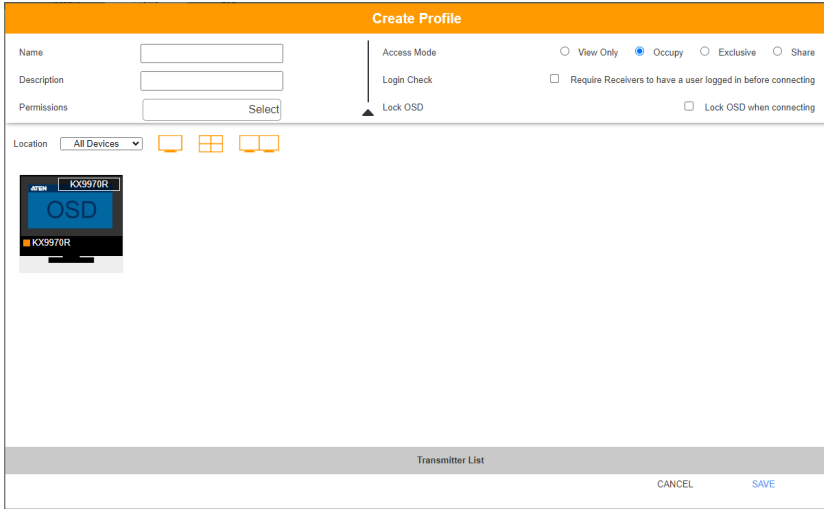

1. On the *Profile* page click  and then select **Create Profile**. The *Create Profile* window appears:



| Item | Description |
|-------------|---|
| Name | Enter a name for the Profile. |
| Description | Enter a description for the Profile. |
| Permissions | Click Select and check the box of the users / groups you want to allow to connect this Profile. When the user logs into a Receiver, the profile will appear listed in the OSD menu on the Profile page (see page 58), allowing them to connect it. |

| Item | Description |
|---|---|
| Access Mode | <p>This defines how the Transmitter in a Profile can be accessed by Receivers when multiple users attempt to access it.</p> <p>View Only: Receivers only have view access to the Transmitter's video display.</p> <p>Share: All users accessing the Transmitter can simultaneously share control of the Transmitter. Input from the users is placed in a queue and executed chronologically.</p> <p>Occupy: Set a time threshold for Receivers whose Access Mode has been set to Occupy. If there is no activity from the Receiver occupying the port for the amount of time set here, the Receiver is timed out and the port is released. The first Receiver to send keyboard or mouse input after the port has been released gets to occupy the port. Input a value from 1 to 240 seconds.</p> <p>Exclusive: The first Receiver to access the Transmitter has exclusive control over the Transmitter. No other users can view the Transmitter. The Timeout function does not apply to Transmitters which have this setting.</p> |
| Login Check | <p>Check this box to require a user to be logged in to the Receiver before a Profile can connect it to a Transmitter. When enabled, a user must be logged into the Receiver or it will not connect to the Transmitter when the Profile is initiated.</p> |
| Lock OSD | <p>Checking this box will lock the Receiver's OSD screen when the Profile connects it to a Transmitter.</p> |
| Location | <p>Use the drop-down menu to select a location to filter the Receivers displayed on the page.</p> |
|  | <p>Click this icon to show individual Receivers.</p> |
|  | <p>Click this icon to show only video wall Receivers.</p> |
|  | <p>Click this icon to show only Receiver Group Receivers.</p> |
| Save | <p>Click to save the changes.</p> |
| Cancel | <p>Click to exit without saving.</p> |

- After filling in the information, click a Receiver, select **Select TX** and use the drop-down menu select a Transmitter; or use *Transmitter List* at the bottom of the page to drag-and-drop Transmitters to Receivers to create the connection.

3. After configuring the connections, click **Save**. The new Profile appears on the *Profile* page.
4. To connect Profiles, check the box of the Profile(s) you want to connect, and click  .
5. To disconnect Profiles, click  .

Adding a Schedule

Creating a Schedule allows you to connect Profiles at specific dates, times and intervals.

To add a Schedule, do the following:

1. On the *Profile* page click **Schedule**.
2. Click **+** and then select **Create Schedule**. The *Create Schedule* window appears:

Create Schedule

Profile Select Profile ▾

Frequency Once ▾

Start Date 2022/6/14

End Date 2022/6/14

Start Time AM ▾ 00 : 00 Disable

End Time AM ▾ 00 : 00 Disable

CANCEL
SAVE

| Item | Description |
|------------|---|
| Profile | Use the drop-down menu to select a Profile to schedule. |
| Frequency | Use the drop-down menu to select how often the Profile should run: Once, Daily, Weekly and Monthly. When you select Weekly/Monthly an additional drop-down menu appears to select the <i>Week Day/Month Day</i> on which the profile will run. |
| Start Date | Enter the date on which you want the schedule to begin running. |
| End Date | Enter the date on which you want the schedule to stop running. |
| Start Time | Enter the time of day that you want the profile to connect. |
| End Time | Enter the time of day that you want the profile to disconnect. |
| Every | If you select Daily, Monthly or Weekly, the <i>Every</i> option appears allowing you to enter how often you want the schedule to run. For example, enter 3 months if you want the profile to run once every three months. If you want to run the schedule once a day, once a week or once a month, use the default entry of 1. |

3. After the schedule is configured, click **Save**.

Log

Click **Log** in the *System Status* panel to open the settings. The *Log* page lists events that take place and provides a breakdown of the time, user, severity, device, and log information. You can change the sort order of the display by clicking on the column headings.

| All Severity | All Device | All User | Time | Log Information |
|--------------|-----------------------|---------------|---------------------|--|
| Information | Profile 2 | administrator | 2022/06/14 10:04:36 | New schedule is added (0#-4) |
| Information | Profile 1 | administrator | 2022/06/14 09:54:43 | New schedule is added (0#-3) |
| Information | Profile 3 | administrator | 2022/06/14 09:54:28 | New profile is added (0#-0001000000000007) |
| Information | Profile 2 | administrator | 2022/06/14 09:54:25 | New profile is added (0#-0001000000000006) |
| Information | Profile 4 | administrator | 2022/06/14 09:54:21 | New profile is added (0#-0001000000000005) |
| Information | Profile 3 | administrator | 2022/06/14 09:53:54 | Profile is removed (0#-0001000000000004) |
| Information | Profile 2 | administrator | 2022/06/14 09:53:54 | Profile is removed (0#-0001000000000003) |
| Information | Profile 1 | administrator | 2022/06/14 09:53:54 | Profile is removed (0#-0001000000000002) |
| Information | Profile 2 | administrator | 2022/06/14 09:49:32 | New schedule is added (0#-2) |
| Information | Profile 1 | administrator | 2022/06/14 09:48:02 | New schedule is added (0#-1) |
| Information | Profile 3 | administrator | 2022/06/14 09:37:48 | New profile is added (0#-0001000000000004) |
| Information | Profile 2 | administrator | 2022/06/14 09:37:44 | New profile is added (0#-0001000000000003) |
| Information | Profile 1 | administrator | 2022/06/14 09:37:32 | New profile is added (0#-0001000000000002) |
| Information | HTTPS from 10.3.66.73 | administrator | 2022/06/14 09:37:01 | Session created/Session*****logoff |
| Information | HTTPS from 10.3.66.73 | administrator | 2022/06/14 09:37:01 | User login succeeded |
| Warning | HTTPS from 10.3.66.73 | administrator | 2022/06/14 09:26:49 | Session terminated/Session*****logoff |
| Information | K00970R | | 2022/06/14 09:26:42 | Device power on (0#010742000500000) |
| Information | K00970R | | 2022/06/14 09:26:42 | Device (0#-0107420005000000) Copper Network is connected |
| Information | K00970R | | 2022/06/14 09:26:39 | Device is back (0#-010742000500000) |
| Error | K00970R | | 2022/06/14 09:26:38 | Device (0#-0107420005000000) has been disconnected from Copper Network |
| Error | K00970R | | 2022/06/14 09:26:38 | Device lost (0#-0107420005000000) |

- Click the drop-down menu beside a heading to filter events into subcategories. Selecting a subcategory allows you to view only the logs that relate to the choice. The meanings of the headings at the top of the page are straightforward:
 - All Severity* refers to the event's severity type: Information, Error, or Warning
 - All Device* refers to the Transmitter or Receiver that relates to the event. If no device is listed the event refers to the KVM over IP Matrix Manager.
 - All User* refers to the username that the event relates to. If no username appears, the event is general system information.
 - Time* refers to the date and time that the event occurred.
 - Log Information* provides detailed information about each event.
- Click to delete the logs currently displayed in the list.
- Click and enter text to search for an event log.
- Click to save the log contents to a file on your computer.

Click to open a pop-up window that allows you to set how many days or the number of records to record before over-writing old log files. Use the radio button to select *By Period (Days)* or *By Records* and enter the number to use before overwriting the oldest log files.

Chapter 7

System Settings

Overview

The *System Settings* are accessed by clicking  from the **System Status** page (see *System Status*, page 93). There are 7 tabs to configure the KVM over IP Matrix Manager system settings: *General*, *ANMS*, *FW Upgrade*, *Redundancy*, *Backup/Restore*, *Certificates*, and *Sessions*.

General

Clicking  from the system status page opens the *General* tab, as shown below:

General
ANMS
FW Upgrade
Redundancy
Backup/Restore
Certificates
Sessions

▼ Basic

KVM over IP Matrix Manager Version 2.2.219 (2022-10-13 17:29)

Hardware Version

CCKM1A2C3B82894F0C
CCKMS865B471761124F2
CCKMS8004E019527A22
CCKMB13A25289E47C0DA

Serial Number [Click to Upgrade](#)

KVM over IP Matrix Manager Name

Description

Language English ▼

Beeper Enable Disable

CCKM Timeout Disable

Authentication Lock Disable

Boundless Switching Focus Always

Push/Pull Login Check Enable Disable

RFID Login Enable Disable

▼ Network Ports

HTTP Port HTTPS Port

Device Port

CLI Port

▼ Fast Switching

Fast Switching Disable Enable

▼ Password Policy

Password Complexity

Minimum Password Length

Enforce Password History

At least one lower case character (a-z).

At least one upper case character (A-Z).

At least one numeric character (0-9).

At least one symbol character (~!@#%&'&()*~=-_~.,:;_).

Password Expiration Enable Disable

Password expires after day(s)

▼ Lockout Policy

Auto Account Lock Enable Disable

Login Attempts time(s)

Timeout min(s)

| Heading | Item | Description |
|---------------------------|---|--|
| Basic | KVM over IP Matrix Manager Version | This provides the version of the KVM over IP Matrix Manager. |
| | Hardware Version | This provides the version of the hardware. |
| | Serial Number | This provides the serial number and a link to upgrade the software. |
| | KVM over IP Matrix Manager Name | Enter a name for the KVM over IP Matrix Manager. |
| | Description | Enter a description for the KVM over IP Matrix Manager. |
| | Language | Select the language for the KVM over IP Matrix Manager. Choices are: English, Chinese (Traditional), Simplified Chinese, Japanese, German, Korean, Russian, French, Spanish, and Portuguese. |
| | Beeper | Select Enable to sound a beep from the Transmitter/Receiver every time a configuration change is made. |
| | CCKM Timeout | If there is no user input for the amount of time entered in the box, a user logged into the CCKM is automatically logged out. Check Disable to turn this function off. |
| | Authentication Lock | <p>When a temporary disconnection happens, this function allows the user to retain his/her settings upon resuming connection within the time threshold set. The user keeps the same authentication and display.</p> <ul style="list-style-type: none"> ◆ Uncheck Disable to turn this function on. ◆ Specify a time (in seconds) you wish to keep the authentication and display for. <p>When disabled or if enabled but after the time threshold set, the user is prompted to be authenticated upon resuming the connection.</p> |
| Boundless Switching Focus | <p>When using Boundless Switching(see <i>Boundless Switching</i>, page 116) across multiple receivers within a receiver group or video wall, a colored border is shown on the receiver display currently being accessed (focus receiver).</p> <ul style="list-style-type: none"> ◆ Uncheck Always to only display the colored border for a set time interval immediately after switching the focus receiver. ◆ Specify a time (in seconds) you wish to display the colored border for upon switching the focus receiver. | |

| Heading | Item | Description |
|----------------|-------------------------|---|
| | Push / Pull Login Check | Enable to check the access rights of the users receiving transmitter sessions upon push / pull. |
| | RFID Login | Enable to activate the RFID login. |
| Network Ports | HTTP Port | Sets the HTTP service port used to access the KVM over IP Matrix Manager. This is the port number to use for a browser login. The default is 8080. |
| | Device Port | Sets the Device service port used to access the KVM over IP Matrix Manager. Configure this port number on the Transmitter and Receiver to access to the KVM over IP Matrix Manager (see <i>Manager Address</i> , page 43 and 48). The default is 9110. |
| | HTTPS Port | Sets the HTTPS service port used to access the KVM over IP Matrix Manager. This is the port number to use for a secure browser login. The default is 8443. Example: To access the KVM over IP Matrix Manager with an IP address of 192.168.0.100 using a secure browser login, enter: <i>https://192.168.0.100:8443</i> |
| Fast Switching | | Select the default resolution to use so that you can switch faster when changing Receiver to Transmitter connections. If the monitor you are using does not support fast switching the video may not display correctly when this setting is enabled. Note: Make sure to disable Boundless Switching when Fast Switching is enabled. |

| Heading | Item | Description |
|-----------------|---|---|
| Password Policy | Password Complexity | <p>This setting determines the minimum password length, enforce password history, and the password requirement policy. This setting is only supported by CCKM using firmware version v2.2.219 or later.</p> <ul style="list-style-type: none"> ◆ Sets the minimum password length, the default setting is 8 characters. ◆ Sets the enforce password history, the default setting is 3 histories. ◆ Sets the password to include at least one lower case character. ◆ Sets the password to include at least one upper case character. ◆ Sets the password to include at least one numeric character. ◆ Sets the password to include at least one symbol character. |
| | Password Expiration | <ul style="list-style-type: none"> ◆ Select Enable to enforce password expiration for a specified time frame in days. This setting is only supported by CCKM using firmware version v2.2.219 or later. |
| Lockout Policy | Lock account after invalid login attempts | <p>Select Enable to enforce the lockout policy if a user types in the wrong password for a specified attempts consecutively, their account will be locked out for a specified time frame in minutes. The default Login Attempts is 5 times, and the timeout is 10 minutes. This setting is only supported by CCKM using firmware version v2.2.219 or later.</p> |
| CLI Mode | CLI Mode Login | <p>Use the radio button to Enable or Disable command line interface logins to the KVM over IP Matrix Manager.</p> <p>Warning: If <i>Disable</i> CLI Mode Login is selected, anybody can login via Telnet with administrator privileges without needing to authenticate, allowing control of the entire installation. For installations requiring a high level of security, it's recommended that <i>Enable</i> CLI Mode Login be applied.</p> |

| Heading | Item | Description |
|-------------------------|----------------------|---|
| Receiver Login Settings | Anonymous Login | Use this to anonymously login a user at select Receivers. This option allows users to access the Receiver and connect to Transmitters without needing to login. Click Device List to display the list and check the box next to the Receiver(s) to enable the <i>Anonymous Login</i> feature. |
| | Anonymous Login User | When <i>Anonymous Login</i> (above) is enabled for Receivers, select a user from the drop-down menu to use as the default account to anonymously login to the Receiver. |
| EDID Mode | EDID Mode | Use this drop-down menu to set the default EDID mode for all Transmitters. To set a different EDID mode for each Transmitter, use the drop-down menu to select Customized and then click Edit . A Transmitter list will appear with drop-down menus to configure each device's EDID mode. |
| Connection Redundancy | | Use this drop-down menu to set connection redundancy function. You can set up priority connection with this function. Please refer to <i>Connection Redundancy</i> below. |
| Pop-up Alert | | Enable and click Edit to select the types of events to automatically trigger and display a pop-up message. |
| JavaClient / WinClient | | Click and drag to adjust the priority of the login access. |
| Save | | Click to save the changes. |
| Cancel | | Click to cancel the changes. |

Connection Redundancy

You can set up priority connection for receivers. When a transmitter becomes inaccessible (such as signal loss or malfunction), this function allows the receiver to connect to the transmitter of the highest priority that is available.

Follow the steps below to setup the priority list.

1. Click **Enable** to enable this function.
2. Click **Edit**. A window will pop-up to allow editing.

3. For Alarm Sound, click **Enable**.

- To create a new list, click **New**. A Priority List 1 will be shown. (Click **New** again to create another list.)

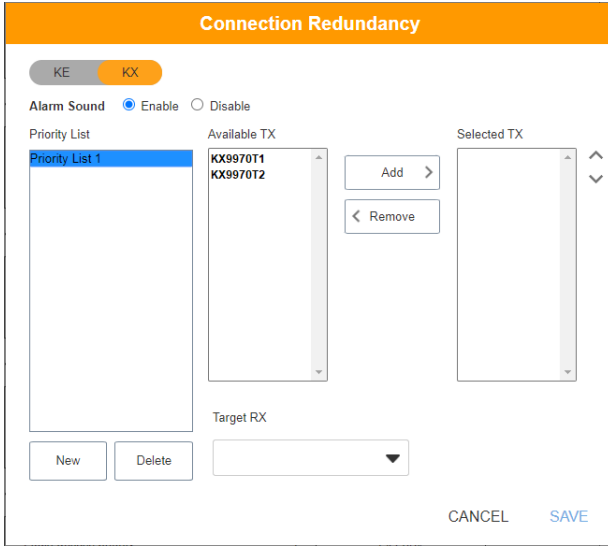

- Select the transmitters you wish to be in the list from the “Available TX” list and click **Add**. The added transmitter will be shifted to the “Selected TX” list.



To deselect the transmitter, click to select the transmitter from the “Selected TX” list and click **Remove**. The transmitter will be shifted back to the “Available TX” list.

6. Select a target receiver by first clicking the drop-down menu “Target RX”, and select a receiver.

The screenshot shows the "Connection Redundancy" settings window. At the top, there are radio buttons for "KE" and "KX", with "KX" selected. Below this, there are radio buttons for "Alarm Sound" with "Enable" selected and "Disable" unselected. The interface is divided into three main sections: "Priority List", "Available TX", and "Selected TX". The "Priority List" section contains a list with "Priority List 1" selected. The "Available TX" section contains a list with "KX9970T1". The "Selected TX" section contains a list with "KX9970T2". Between the "Available TX" and "Selected TX" lists are "Add" and "Remove" buttons. At the bottom, there is a "Target RX" dropdown menu with "KX9970R" selected, and "New" and "Delete" buttons. The bottom right corner has "CANCEL" and "SAVE" buttons.

7. Repeat steps 4-6 to add more priority lists.
8. Click **Save** to save the settings.

ANMS

The *ANMS* (Advanced Network Management Settings) tab is used to set up login authentication and authorization management from external sources, and SNMP configurations. It is organized into three pages, as described below.

Event Destination

General
ANMS
FW Upgrade
Redundancy
Backup/Restore
Certificates
Sessions

Event Notification

Authentication

SNMP

SMTP

Syslog

▼ **General**

| Event | SNMP | SMTP | Syslog |
|--------------------------------|--------------------------|--------------------------|--------------------------|
| ▼ Authentication Events | | | |
| Login | <input type="checkbox"/> | <input type="checkbox"/> | <input type="checkbox"/> |
| Login fail | <input type="checkbox"/> | <input type="checkbox"/> | <input type="checkbox"/> |
| logout | <input type="checkbox"/> | <input type="checkbox"/> | <input type="checkbox"/> |
| ▼ Device events | | | |
| Modify device configuration | <input type="checkbox"/> | <input type="checkbox"/> | <input type="checkbox"/> |
| Device power off | <input type="checkbox"/> | <input type="checkbox"/> | <input type="checkbox"/> |
| Device fiber disconnected | <input type="checkbox"/> | <input type="checkbox"/> | <input type="checkbox"/> |
| Device copper disconnected | <input type="checkbox"/> | <input type="checkbox"/> | <input type="checkbox"/> |
| ▼ User Events | | | |
| Add a new user | <input type="checkbox"/> | <input type="checkbox"/> | <input type="checkbox"/> |
| User information modified | <input type="checkbox"/> | <input type="checkbox"/> | <input type="checkbox"/> |
| Delete a current user | <input type="checkbox"/> | <input type="checkbox"/> | <input type="checkbox"/> |
| ▼ System setting events | | | |
| General settings modified | <input type="checkbox"/> | <input type="checkbox"/> | <input type="checkbox"/> |
| ANMS settings modified | <input type="checkbox"/> | <input type="checkbox"/> | <input type="checkbox"/> |
| FW upgraded | <input type="checkbox"/> | <input type="checkbox"/> | <input type="checkbox"/> |
| Redundancy settings modified | <input type="checkbox"/> | <input type="checkbox"/> | <input type="checkbox"/> |
| Backup success | <input type="checkbox"/> | <input type="checkbox"/> | <input type="checkbox"/> |
| Restore success | <input type="checkbox"/> | <input type="checkbox"/> | <input type="checkbox"/> |
| New certificate created | <input type="checkbox"/> | <input type="checkbox"/> | <input type="checkbox"/> |
| Certificate imported | <input type="checkbox"/> | <input type="checkbox"/> | <input type="checkbox"/> |
| Default certificate restored | <input type="checkbox"/> | <input type="checkbox"/> | <input type="checkbox"/> |
| Kill a session | <input type="checkbox"/> | <input type="checkbox"/> | <input type="checkbox"/> |
| Redundancy server disconnected | <input type="checkbox"/> | <input type="checkbox"/> | <input type="checkbox"/> |

▼ **Input Trigger Events**

| Event Name | SNMP | SMTP |
|------------|------|------|
| No Events | | |
| Add New | | |

SAVE

CANCEL

- ◆ *General*: Check the checkbox to enable Authentication, Device, User, System Setting event notification through SNMP, SMTP, and/or Syslog.
- ◆ *Input Trigger Events*: Click [Add New](#) to add a device and check the checkbox to enable event notification through SNMP and SMTP.
- ◆ *Save*: Click **Save** to save changes.
- ◆ *Cancel*: Click **Cancel** to exit without saving.

Authentication

The screenshot shows the 'Authentication' configuration page with the following sections:

- RADIUS Settings**
 - Enable
 - Preferred RADIUS Server: []
 - Preferred RADIUS Server Port: 1812
 - Alternate RADIUS Server: []
 - Alternate RADIUS Server Port: 1815
 - Timeout: 5
 - Retries: 3
 - Shared Secret (at least 6 characters): []
- LDAP / AD Settings**
 - Enable
 - Enable SSL
 - Preferred LDAP Server: []
 - Preferred LDAP Server Port: 389
 - Alternate LDAP Server: []
 - Alternate LDAP Server Port: 389
 - Timeout: 10
 - Admin DN: []
 - Admin Name: []
 - Password: []
 - Search DN: []
- TACACS+ Settings**
 - Enable
 - Preferred TACACS+ Server: []
 - Preferred TACACS+ Server Port: 49
 - Shared Secret (at least 6 characters): []
 - Alternate TACACS+ Server: []
 - Alternate TACACS+ Server Port: 49
 - Shared Secret (at least 6 characters): []

Buttons: SAVE, CANCEL

◆ *RADIUS Settings*

To allow authentication and authorization through a RADIUS server, do the following:

1. Check **Enable**.
2. Fill in the IP addresses and service port of the *Preferred RADIUS Server* and *Alternate RADIUS Server*.
3. In the *Timeout* field, set the time in seconds that the KVM over IP Matrix Manager waits for a RADIUS server reply before it times out.

4. In the *Retries* field, set the number of allowed retries.
5. In the *Shared Secret* field, key in the character string that you want to use for authentication between the KVM over IP Matrix Manager and the RADIUS Server. A minimum of 6 characters is required.
6. On the RADIUS server, Users can be authenticated with any of the following methods:
 - ◆ Use the same Username on both the RADIUS server and the KVM over IP Matrix Manager.
 - ◆ Use the same Group name on both the RADIUS server and the KVM over IP Matrix Manager.
 - ◆ Use the same Username/Group name on both the RADIUS server and the KVM over IP Matrix Manager.

In each case, the user's access rights are the ones assigned that were assigned when the User or Group was created on the KVM over IP Matrix Manager.

◆ *LDAP / AD Settings:*

To allow authentication and authorization for the KVM over IP Matrix Manager via LDAP / AD, refer to the information in the table, below:

| Item | Action |
|------------|---|
| Enable | Put a check in the Enable checkbox to allow LDAP / AD authentication and authorization. |
| Enable SSL | Put a check in the Enable checkbox to allow SSL connections. |

| Item | Action |
|---|---|
| Preferred LDAP Server / Alternate LDAP Server | Fill in the IP address for the LDAP / AD server. <ul style="list-style-type: none"> ◆ You can use the IPv4 address, the IPv6 address or the domain name in the LDAP Server field. |
| Preferred LDAP Server Port / Alternate LDAP Server Port | Fill in the port number for the LDAP / AD server. <ul style="list-style-type: none"> ◆ For LDAP, the default port number is 389. |
| Timeout | Set the time in seconds that the KVM over IP Matrix Manager waits for an LDAP / AD server reply before it times out. |
| Admin DN | Consult the LDAP / AD administrator to ascertain the appropriate entry for this field. For example, the entry might look like this: ou=kn4132,dc=aten,dc=com |
| Admin Name | Key in the LDAP administrator's username. |
| Password | Key in the LDAP administrator's password. |
| Search DN | Set the distinguished name of the search base. This is the domain name where the search starts for user names. |

On the LDAP / AD server, Users can be authenticated with any of the following methods:

- ◆ With MS Active Directory schema.

Note: If this method is used, the LDAP schema for MS Active Directory must be extended. Without schema – Only the Usernames used on the KVM over IP Matrix Manager are matched to the names on the LDAP / AD server. User privileges are the same as the ones configured in the KVM over IP Matrix Manager.

- ◆ Without schema – Only the Usernames used on the KVM over IP Matrix Manager are matched to the names on the LDAP server. User privileges are the same as the ones configured in the KVM over IP Matrix Manager.
- ◆ Without schema – Only Groups in AD are matched. User privileges are the ones configured for the groups he belongs to in the KVM over IP Matrix Manager.
- ◆ Without schema – Usernames and Groups in AD are matched. User privileges are the ones configured for the User and the Groups in the KVM over IP Matrix Manager.

- ◆ *TACACS+ Settings:*

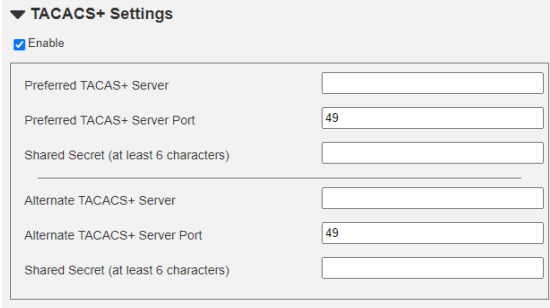

▼ TACACS+ Settings

Enable

| | |
|---------------------------------------|---------------------------------|
| Preferred TACACS+ Server | <input type="text"/> |
| Preferred TACACS+ Server Port | <input type="text" value="49"/> |
| Shared Secret (at least 6 characters) | <input type="text"/> |
| <hr/> | |
| Alternate TACACS+ Server | <input type="text"/> |
| Alternate TACACS+ Server Port | <input type="text" value="49"/> |
| Shared Secret (at least 6 characters) | <input type="text"/> |

- ◆ **Enable** TACACS+ and enter the following information:
 - ◆ Preferred TACACS+ Server
 - ◆ Preferred TACACS+ Service Port
 - ◆ Shared Secret 1
 - ◆ Alternate TACACS+ Server
 - ◆ Alternate TACACS+ Service Port
 - ◆ Shared Secret 2
- ◆ *Save:* Click **Save** to save changes.
- ◆ *Cancel:* Click **Cancel** to exit without saving.

SNMP

◆ *SNMP Trap & SNMP Agent*

To be notified of SNMP trap events, do the following:

1. Check **Enable** SNMP Trap.
2. Enter the **Primary Server IP** and the **Service Port** of the PC / server to be notified of SNMP trap events.
3. Enter the **Redundancy Server IP** and the **Service Port** of the redundant PC / server to be notified of SNMP trap events.
4. Fill in the Community field.
5. Check **Enable** SNMP Agent.
6. Check / uncheck the SNMP Agents for sending SNMP trap events.

Note: To add additional SNMP Agents, you must first **Enable** SNMP Agent.

7. Click **Save**.

SMTP

◆ *SMTP Settings*

To have the KVM over IP Matrix Manager email reports from the SMTP server to you, do the following:

1. Enable the ***Enable report from the following SMTP Server***, and key in the *SMTP Server* IP address and *SMTP Port*.

Note: The SMTP server used can either be TLS-encrypted or unencrypted. CCKM shall send TLS-encrypted or unencrypted email reports depending on the type of the SMTP server connected.

2. If your server requires authentication, check the ***Server requires authentication*** checkbox, and key in the appropriate information for the *Account Name* and *Password* fields.
3. Key in the email address of where the report is being sent from in the *From* field.

Note: 1. Only one email address is allowed in the *From* field, and it cannot exceed 64 Bytes.

2. 1 Byte = 1 English alphanumeric character.
-

4. Key in the email address (addresses) of where you want the SMTP reports sent to in the *To* field.

Note: If you are sending the report to more than one email address, separate the addresses with a semicolon. The total cannot exceed 256 Bytes.

5. Click **Save**.

Note: 1. Once set, an SMTP report will be sent to the recipients for every 100 logs accumulated or once every 30 minutes.

2. An immediate SMTP report will also be sent whenever an error log occurs.

Syslog

The screenshot shows a web interface for configuring Syslog settings. At the top, there are several tabs: General, ANMS, FW Upgrade, Redundancy, Backup/Restore, Certificates, and Sessions. Below these, there are sub-tabs: Event Notification, Authentication, SNMP, SMTP, and Syslog (which is currently selected). The Syslog Settings section is expanded, showing a checkbox for 'Enable' which is checked. Below this, there are two input fields: 'Server IP' and 'Service Port'. The 'Service Port' field contains the value '514'. At the bottom right of the form, there are two buttons: 'SAVE' and 'CANCEL'.

◆ Syslog Settings

To record all the events that take place on the KVM over IP Matrix Manager and write them to a Syslog server, do the following:

1. Check **Enable**.
2. Key in the **Server IP** address of the Syslog server.
3. Key in the **Service Port** number. The valid port range is 1-65535.
4. Click **Save**.

FW Upgrade

In *FW Upgrade* all KX devices that are online are listed, allowing you to select which devices get upgraded. New firmware versions can be downloaded from our website as they become available. Check the website regularly to find the latest upgrade packages.

To upgrade the firmware do the following:

1. Go to our website and download the firmware upgrade package appropriate to your KX device.
2. Open your browser and log in to the KVM over IP Matrix Manager with an administrator's account.
3. Click the **Settings** icon; select the **FW Upgrade** tab, the *FW Upgrade* page appears:

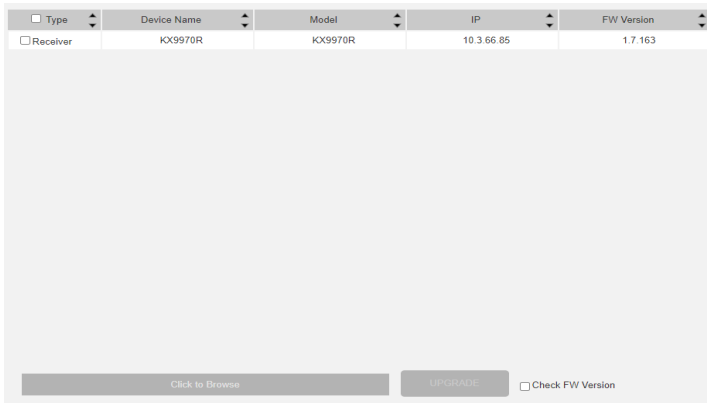

All the devices that are capable of being upgraded are listed.

Note: Only online devices show up in the list. Offline devices do not get upgraded.

4. Check the checkbox in front of the devices you want to upgrade. Uncheck the devices that you do not want to upgrade.
5. Click **Browse**. Navigate to the directory where the firmware upgrade file is located and select it.
6. Enable or disable *Check FW Version*
 - ◆ If you enabled *Check FW Version* the current firmware level is compared with that of the upgrade file. If the current version is equal to

or higher than the upgrade version, a popup message appears, to inform you of the situation and stops the upgrade procedure.

- ♦ If you didn't enable *Check FW Version*, the upgrade file is installed without checking what its level is.
 - ♦ If you cancel the firmware upgrade, you have to wait 12 seconds before you can disable *Check FW Version* and restart the firmware upgrade.
7. Click **Upgrade** to start the upgrade procedure. As the upgrade proceeds, progress information is shown on the screen. Once the upgrade completes successfully, the devices will reset.
 8. Log in to each device and check the firmware version to be sure it is the new one.

Firmware Upgrade Recovery

If the Upgrade Succeeded screen doesn't appear or the upgrade procedure is abnormally halted (due to computer crash, power failure, etc.), the device may become inoperable. If you find that the device does not work following a failed or interrupted upgrade, do the following

1. Power off the KX device.
2. Press the **Reset** button, then power on the KX device while holding Reset.
3. Hold **Reset** for 7 seconds after the device is powered on.
4. The device will revert to a previous firmware version and recover from the failure.
5. Upgrade the firmware to the most current version available.

Redundancy

The *Redundancy* tab allows you to set up a backup computer in case the computer hosting the KVM over IP Matrix Manager goes offline. If the KVM over IP Matrix Manager goes offline, the secondary computer will automatically take over operations, allowing all connections to continue without disruption – with only a brief period of 30 seconds when new connections can't be started. When the primary computer comes back online it retrieves the updated database from the secondary computer and re-takes all KVM over IP Matrix Manager operations.

A CCKM supports up to 5 secondary servers.

To set up Redundancy, do the following:

1. Install KVM over IP Matrix Manager on a secondary computer with a USB license key. For detailed instructions, see page 66.

Note: A second USB license key is required if you have more than 8 KX Series devices in your setup.

2. On the secondary computer, log in to the KVM over IP Matrix Manager, click  and go to the *Redundancy* tab.

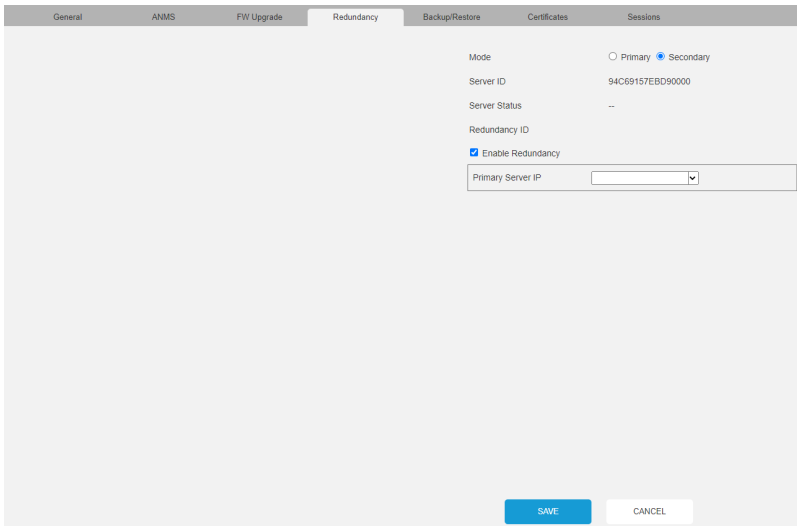

General ANMS FW Upgrade **Redundancy** Backup/Restore Certificates Sessions

Mode Primary Secondary

Server ID 94C69157EBD9000

Server Status --

Redundancy ID --

Enable Redundancy

Primary Server IP

SAVE CANCEL

3. Check **Enable Redundancy** and select the **Secondary** radio button.

4. Use the **Primary Server IP** drop-down menu to select the primary IP address.
5. Click **Save**.
6. Redundancy is now running on the secondary computer.
7. On the primary computer, log in to the KVM over IP Matrix Manager, click  and go to the *Redundancy* tab.

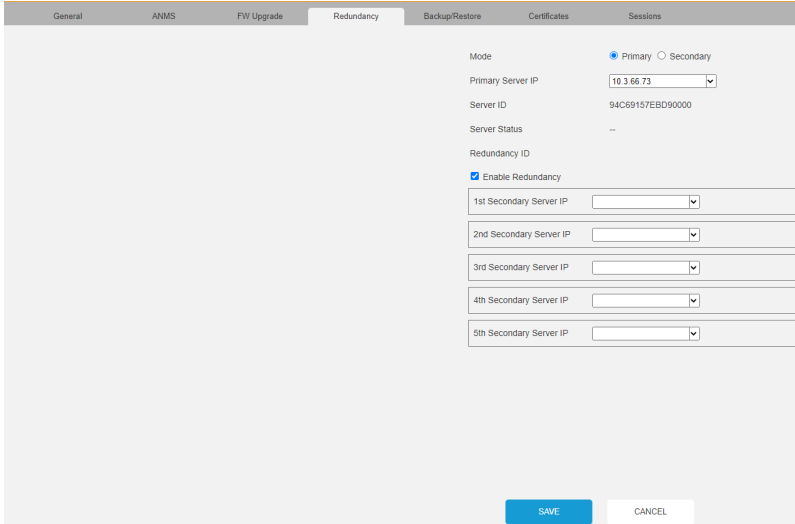

General ANMS FW Upgrade **Redundancy** Backup/Restore Certificates Sessions

Mode Primary Secondary

Primary Server IP

Server ID 94C69157EBD90000

Server Status --

Redundancy ID

Enable Redundancy

1st Secondary Server IP

2nd Secondary Server IP

3rd Secondary Server IP

4th Secondary Server IP

5th Secondary Server IP

SAVE CANCEL

8. Check **Enable Redundancy** and select the **Primary** radio button.
9. Use the **Secondary Server IP** drop-down menu to select the secondary IP address.
10. Enter the **Username** and **Password** of the secondary computer's local administrator account.
11. Click **Save**.
12. Information about the *Redundancy* status can be found in the event log (see *Log*, page 134 for details).

Backup / Restore

The *Backup/Restore* tab is divided into three panels: **Backup**, **Restore**, and **Export Device List**:

The screenshot shows the 'Backup/Restore' tab in a web interface. At the top, there are navigation tabs: General, ANMS, FW Upgrade, Redundancy, Backup/Restore (selected), Certificates, and Sessions. Below these are three main sections:

- Backup:** Contains a blue 'BACKUP' button, an 'Add Password' checkbox, and a password input field.
- Restore:** Contains a 'Click to browse backup file' button, a 'RESTORE' button, and a 'Password' input field.
- Export Device List:** Contains a blue 'EXPORT' button.

The operations to perform backup/restore procedures are described in the table below and in the section that follows:

| Procedure | Operation |
|--------------------|---|
| Backup | Backs up the KVM over IP Matrix Manager configuration – including profile and schedule configurations, user and group accounts, user profiles, logs, and system settings. |
| Restore | Deletes the current profile and schedule configurations, user and group accounts, user profiles, logs, and system settings; then restores those settings to the values that exist in the previously saved backup file. |
| Export Device List | Clicking Export allows you to save a file with a complete list of the devices added to the KVM over IP Matrix Manager. The file contains the ID, name, description and IP address of each transmitter and receiver. An Existing column also lists if the device is available: Yes, it exists and is available, or No, it is offline or has been removed. |

Backup

To back up system configuration settings, do the following:

1. (Optional) In the *Backup* panel, check **Add Password**, and provide a password for the backup file.

Note: Providing a password is a security feature – if you provide a password, you will need to give the same password in order to restore the configuration settings from this file.

2. Click **Backup**.
3. In the dialog box that comes up, Click **Save** to save the configuration file (*System.conf*) to a location on your hard disk.
4. Navigate to the directory where you want to save the file and click **Save**.

Restore

To restore system configuration settings, do the following:

1. In the *Restore* panel, click **Browse**.
2. Navigate to the directory where the backup file is located and select it.
3. When you return to the *Backup/Restore* page enter the password you set when the backup file was created.

Note: If you did not set a password for the file, leave the field blank.

4. Click **Restore**.
5. Click **OK** to confirm that you want to restore the configuration data.
When the Restore procedure is in process, a message stating that the KVM over IP Matrix Manager will restart will appear. After a short while the KVM over IP Matrix Manager closes and refreshes at the log in screen. When it comes back up the configuration settings that were restored from the backup file are in effect.

Certificates

This tab provides information about *Private Certificates*:

| General | ANMS | FW Upgrade | Redundancy | Backup/Restore | Certificates | Sessions |
|--|---|------------|------------|----------------|--------------|----------|
| Issued To | | | | | | |
| Common Name (CN) | ATEN INTERNATIONAL CO. LTD | | | | | |
| Organization (O) | ATEN INTERNATIONAL CO. LTD | | | | | |
| Organization Unit (OU) | R&D | | | | | |
| Country (C) | TW | | | | | |
| State or Province (ST) | New Taipei City | | | | | |
| Locality (L) | Sijsh District | | | | | |
| Email Address (E) | eservice@aten.com.tw | | | | | |
| Serial Number | 00 9D 5D A9 CA 7F 4D B5 3B | | | | | |
| Issued By | | | | | | |
| Common Name (CN) | ATEN INTERNATIONAL CO. LTD | | | | | |
| Organization (O) | ATEN INTERNATIONAL CO. LTD | | | | | |
| Organization Unit (OU) | R&D | | | | | |
| Validity | | | | | | |
| Issued On | 2016/03/17 05:40:43 | | | | | |
| Expires On | 2026/03/16 05:40:43 | | | | | |
| Fingerprints | | | | | | |
| SHA1 Fingerprint | EE 55 7F 72 13 B7 A9 40 00 32 E8 A0 AB 8C 9F 4B C8 65 B5 A5 | | | | | |
| MD5 Fingerprint | A6 C6 B2 69 72 9C 05 B4 51 7B 2E 43 61 79 9B E8 | | | | | |
| <input type="button" value="NEW"/> <input type="button" value="GET CSR"/> <input type="button" value="IMPORT"/> <input type="button" value="RESTORE DEFAULT"/> | | | | | | |

Private Certificate

When logging in over a secure (SSL) connection, a signed certificate is used to verify that the user is logging in to the intended site. For enhanced security, the *Private Certificate* section allows you to use your own private encryption key and signed certificate, rather than the default ATEN certificate.

There are two methods for establishing your private certificate: generating a self-signed certificate; and importing a third-party certificate authority (CA) signed certificate.

- ◆ **Generating a Self-Signed Certificate**

If you wish to create your own self-signed certificate, a free utility – openssl.exe – is available for download over the web. See *Self-Signed Private Certificates*, page 232 for details about using OpenSSL to generate your own private key and SSL certificate.

- ◆ **Obtaining a CA Signed SSL Server Certificate**

For the greatest security, we recommend using a third party certificate authority (CA) signed certificate. To obtain a third party signed certificate, go to a CA (Certificate Authority) website to apply for an SSL certificate.

After the CA sends you the certificate and private encryption key, save them to a convenient location on your computer.

- ◆ **Importing the Private Certificate**

To import the private certificate, do the following:

1. Click **Import** from the bottom of the Private Certificate page, shown here:



2. Click **Browse** to the right of *Certificate Filename*; and browse to where your certificate file is located; and select it.
3. Click **Import** to complete the procedure.

Note: Clicking **Restore Defaults** returns the device to using the default ATEN certificate.

Certificate Signing Request

The Certificate Signing Request (CSR) section provides an automated way of obtaining and installing a CA signed SSL server certificate.

To perform this operation do the following:

1. Click **New**. The following dialog box appears:

 A dialog box titled 'New Certificate' with an orange header. It contains seven input fields, each with a label to its left: 'Country (2 letter code)', 'State or Province (ST)', 'Locality (L)', 'Organization (O)', 'Organization Unit (OU)', 'Common Name (CN)', and 'Email Address (E)'. At the bottom right, there are two buttons: 'CANCEL' and 'CREATE'.

2. Fill in the form – with entries that are valid for your site – according to the example information in the following table:

| Information | Example |
|-------------------------|---------|
| Country (2 letter code) | TW |
| State or Province (ST) | Taiwan |

| Information | Example |
|------------------------|--|
| Locality (L) | Taipei |
| Organization (O) | Your Company, Ltd. |
| Organization Unit (OU) | Tech Department |
| Common Name (CN) | mycompany.com Note: This must be the exact domain name of the site that you want the certificate to be valid for. If the site's domain name is <i>www.mycompany.com</i> , and you only specify <i>mycompany.com</i> , the certificate will not be valid. |
| Email Address (E) | administrator@yourcompany.com |

3. After filling in the form (all fields are required), click **Create**.

A self-signed certificate based on the information you just provided is now stored on the KVM over IP Matrix Manager.

4. Click Get CSR, and save the certificate file (*csr:cer*) to a convenient location on your computer.

This is the file that you give to the third party CA to apply for their signed SSL certificate.

5. After the CA sends you the certificate, save it to a convenient location on your computer. Click **Import** to locate the file; then click **Import** to store it on the KVM over IP Matrix Manager.

Note: When you upload the file, the KVM over IP Matrix Manager checks the file to make sure the specified information still matches. If it does, the file is accepted; if not, it is rejected.

If you want to remove the certificate (to replace it with a new one because of a domain name change, for example), simply click **Restore Defaults**.

Sessions

The *Sessions* tab shows all of the users that are logged into KVM over IP Matrix Manager and OSD sessions and provides information concerning the “who, where and when” of each session. This page also gives the administrator the option of forcing a user logout by selecting the user and clicking **Kill Session** next to each user.

| General | ADMS | FW Upgrade | Redundancy | Backup/Restore | Certificates | Sessions |
|---------------|---------------|------------|------------|---------------------|---------------------|---|
| Username | User Type | Service | IP | Login Time | Last Access | Operation |
| administrator | Administrator | HTTPS | 10.3.66.73 | 2022/05/14 17:14:19 | 2022/05/14 17:20:04 | <input type="button" value="Kill Session"/> |

- ◆ *Username* refers to the user that logged in to establish a session.
- ◆ *User Type* refers to the account type of the user.
- ◆ *Service* refers to how the user logged into their session – via KVM over IP Matrix Manager, Command Line, or OSD.
- ◆ *IP* refers to the IP address from which the user has logged in.
- ◆ *Login Time* refers to the date/time that the user logged into the session.
- ◆ *Last Access* refers to the last time the user session was active.
- ◆ *Operation* provides the **Kill Session** button to force a user logout.

This Page Intentionally Left Blank

Chapter 8

Connections

Overview

The *Connections* panel is found on the **KVM over IP Matrix Manager** main page, just below System Status. Connections provides a diagram of current Transmitter to Receiver connections. Before connections are established the panel appears blank, as shown below. To connect Receivers to Transmitters, use the *Instant Link* panel (page 85), or create a connection *Profile* (page 129).

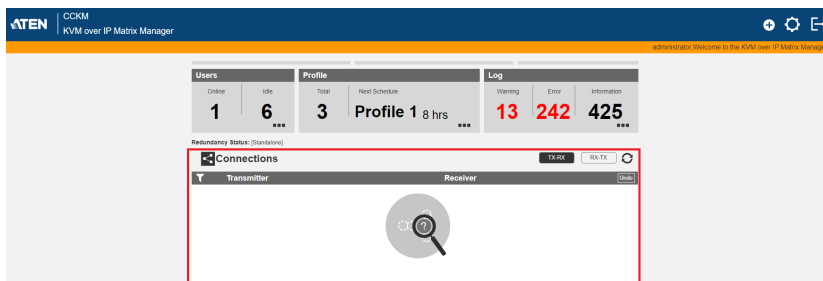

When connections are made, clicking a device in the left column provides a way to view the connection, hovering the mouse cursor over the connection diagram in the right column allows you to disconnect the device, as explained in the sections that follows.

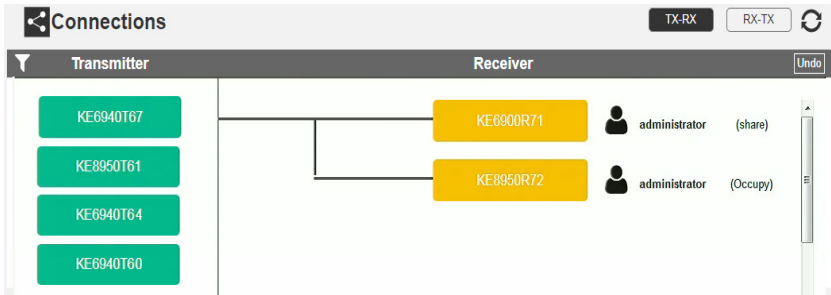

Connections

When Receivers connect to Transmitters, they appear in the *Connections* panel. There are two columns – each lists either Transmitters or Receivers. The columns can be swapped by clicking the **TX-RX** or **RX-TX** button. Devices in the left column can be clicked to display their connection to devices, shown in the right column. Connections, shown in the right column, can be disconnected by clicking the **X** over the connection diagram.

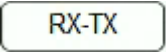

| Item | Description |
|---|---|
|  | On the heading bar under <i>Connections</i> , click this icon to change the sort order of the Transmitters or Receivers listed in the left column. |
| Left Column | Click a device in the left column to view its connection in the right column. A diagram to its connected device(s) appears in the right column. |
| Right Column | The right column displays a connection diagram when a device in the left column is selected. Move the mouse cursor over the diagram and click X to disconnect the devices. This column also shows the user and access type (Exclusive, Occupy, Share, View Only) used to establish the connection. |
| Transmitter | Lists Transmitters that are online and connected to Receivers. |
| Receiver | Lists Receivers that are online and connected to Transmitters. |
|  | Click to view Transmitter to Receiver connections. This will list Transmitters in the left column so that they can be selected to view their connection diagram, shown in the right column. |
|  | Click to view Receiver to Transmitter connections. This will list Receivers in the left column so that they can be selected to view their connection diagram, shown in the right column. |

| Item | Description |
|---|--|
|  | Click this icon to Refresh the Transmitters and Receivers list in Connections panel. |
| Undo | Click this icon to undo the most recent disconnection. |

Based on the different access types, users attempting to connect to device ports that are already being accessed by another user may or may not be able to connect. See the table below for scenarios where users are granted (O) or denied access (X).

| New Connect Attempt Currently Connected | Exclusive | Share | Occupy | View Only |
|--|------------------|--------------|---------------|------------------|
| EXCLUSIVE | X | X | X | X |
| Share | X | O | X | O |
| Occupy | X | X | O | O |
| View Only | X | O | O | O |
| None | O | O | O | O |

This Page Intentionally Left Blank

Chapter 9

Scheduled Profile

Overview

The *Scheduled Profile* panel is found on the **KVM over IP Matrix Manager** main page, just below Connections. Scheduled Profiles displays connection profiles that have been scheduled. Click **Go to Schedule** to edit and create profile schedules (page 129). To create Profiles, see page 130.

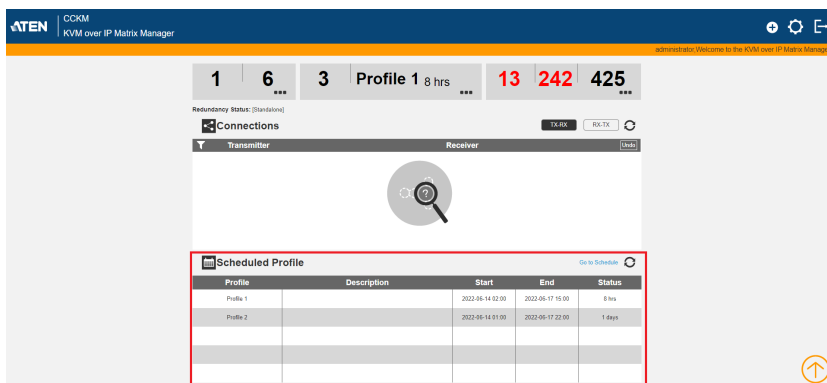

| Item | Description |
|---|---|
| Headings | The headings provide the schedules: <i>Name</i> , <i>Description</i> , <i>Start</i> , <i>End</i> , and <i>Status</i> . Start and End show the time/date the profile is scheduled to begin and end. Status displays the number of days until to the next scheduled run. |
| Go to Schedule | Clicking Go to Schedule opens the <i>Profile</i> settings page which allows you to create and edit connection profiles. See <i>Profile</i> , page 129 for details. |
|  | Click this icon to Refresh the connections list in the right column. |

This Page Intentionally Left Blank

Chapter 10 Sessions

Overview

The *Sessions* panel is found at the bottom of the **KVM over IP Matrix Manager** main page, just below Scheduled Profile. Sessions displays information about users logged into devices and the KVM over IP Matrix Manager web GUI. Click **Go to Sessions** to view the settings page (see page 163).

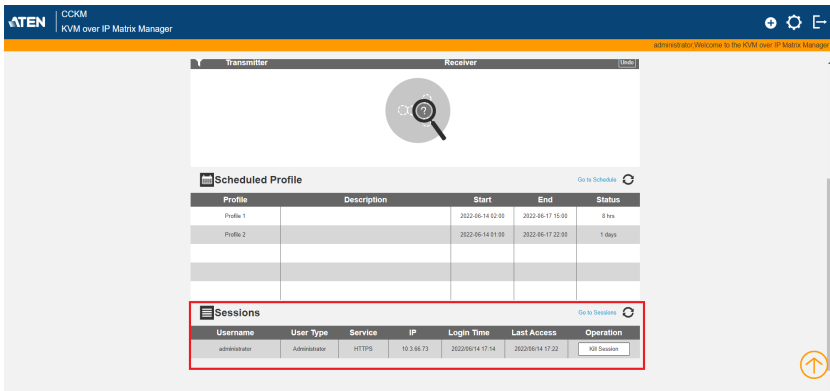

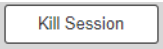
| Item | Description |
|---|--|
| Headings | The headings provide information about each user session: <i>Username</i> , <i>User Level</i> , <i>Service</i> , <i>IP</i> , <i>Login Time</i> , and <i>Last Access</i> . For more details about each heading, see <i>Sessions</i> , page 163. |
| Go to Sessions | Clicking Go to Sessions opens the <i>Sessions</i> settings page which provides a page displaying the same information found in this panel. |
|  | Click this icon to Refresh the Sessions list. |
|  | Click to kill and stop operation from the selected session. |

This Page Intentionally Left Blank

Chapter 11

ATEN Matrix Link

Overview

The ATEN Matrix Link is a mobile app that allows users to access the CCKM server from an iPad for convenient remote monitoring and management.

Requirements

Before using ATEN Matrix Link, make sure your iPad meets the following requirements:

- ♦ Running iPadOS 9.0 or later
- ♦ Has ATEN Matrix (Instant) Link installed, available from the App Store.
- ♦ Connected to the same network as the CCKM server.

IMPORTANT: To use ATEN Matrix Link, the CCKM server's license must be activated.

Accessing CCKM

1. On the ATEN Matrix Link app, enter the IP address and service port value of the CCKM server, and tap **Connect**, as exemplified below.



- The account selection page appears, displaying all of the CCKM server's user accounts. Select the user account you want to use for accessing the CCKM server. Upon selecting, you must enter the password of the account and tap **Login**.





- Once successfully logged in, the ATEN Matrix Link app's main page appears, resembling the CCKM server's Instant Link function, as exemplified below.



Monitoring

Adjusting Preview Size

For easy monitoring, users can tap 1 of the 3 following icons to display the preview of transmitters and/or receivers in small, medium, or large images, as described below.

| Preview Size | Description |
|--|--|
| Large  | Displays the previews of the transmitters / receivers in large images (2 per row) |
| Medium  | Displays the previews of the transmitters / receivers in medium images (4 per row) |
| Small  | Displays the previews of the transmitters / receivers in small images (6 per row) |

Searching for a Device

To search for a particular transmitter and/or receiver device, simply enter the name or IP address of the transmitter and/or receiver you want to search for and tap the search icon.



Checking a Receiver's Tx-Connection

To check which transmitter a receiver is currently connected to, simply long-tap that receiver until the name of the transmitter or Tx group it is connected to is displayed, as exemplified below.



You can optionally disconnect the receiver from the transmitter by tapping **Disconnect**.

If no transmitter is currently connected, *No connection* is displayed, as exemplified below.

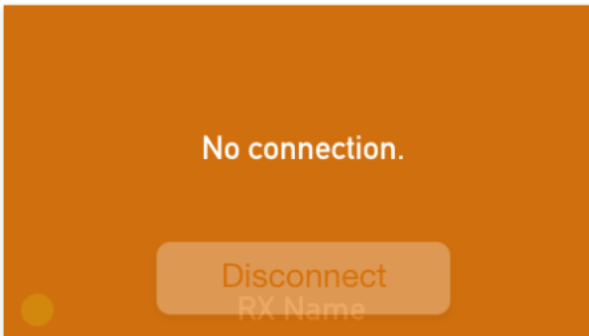

Connecting Tx-Rx

To connect a transmitter or Tx group to the desired receiver or Rx group, do the following:

1. First, select the access privilege you want the receiver to control the transmitter with from the following drop-down list.

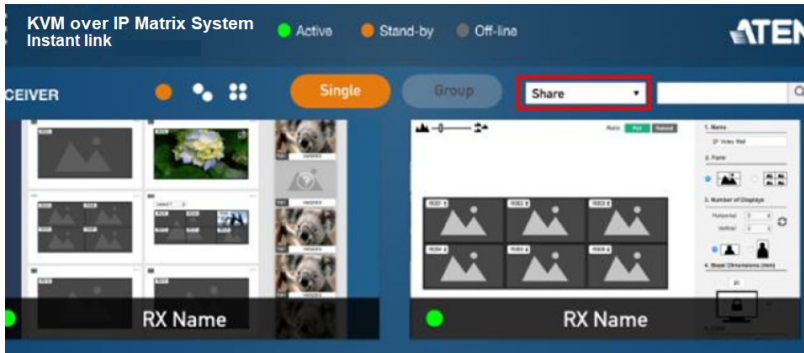

2. Tap and drag the desired transmitter device or Tx group to the desired receiver or Rx group, as illustrated below.



Access Types

Based on the different access types, users attempting to connect to device ports that are already being accessed by another user may or may not be able to connect. See the table below for scenarios where users are granted (O) or denied access (X).

| New Connect Attempt Currently Connected | Exclusive | Share | Occupy | View Only |
|--|-----------|-------|--------|-----------|
| EXCLUSIVE | X | X | X | X |
| Share | X | O | X | O |
| Occupy | X | X | O | O |
| View Only | X | O | O | O |
| None | O | O | O | O |

Logout

To log out of the user account, currently used to access the CCKM server, tap **Menu** and then tap **Log out**.



Chapter 12

Firmware Upgrade Utility

The Windows-based Firmware Upgrade Utility (FWUpgrade.exe) provides a smooth, automated process for upgrading the firmware. The Utility comes as part of a Firmware Upgrade Package that is specific for each device. New firmware upgrade packages are posted on our web site as new firmware revisions become available. Check the web site regularly to find the latest packages and information relating to them:

<http://www.aten.com>

For browser based firmware upgrade, please refer to *FW Upgrade* on page 154.

Preparation

1. From a computer that is not part of your installation go to our Internet support site and choose the model name that relates to your KX device to get a list of available Firmware Upgrade Packages.
2. Choose the Firmware Upgrade Package you want to install (usually the most recent), and download it to your computer.
3. Be sure that the computer is connected to the same LAN segment as the KX devices.

Starting the Upgrade

To upgrade your firmware:

1. Run the downloaded Firmware Upgrade Package file - either by double clicking the file icon, or by opening a command line and entering the full path to it. The Firmware Upgrade Utility Welcome screen appears, select Firmware Upgrade Utility, and click **Next**.

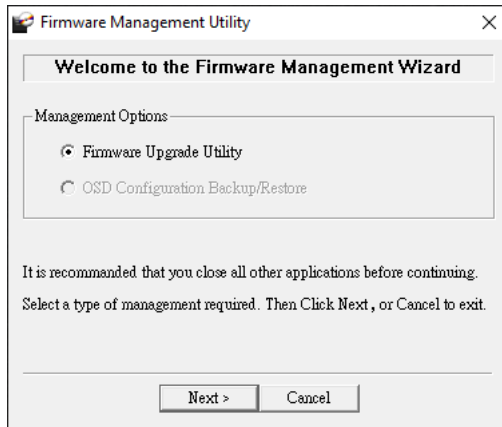

Note: The screens shown in this section are for reference only.

2. Read the License Agreement (enable the *I Agree* radio button).

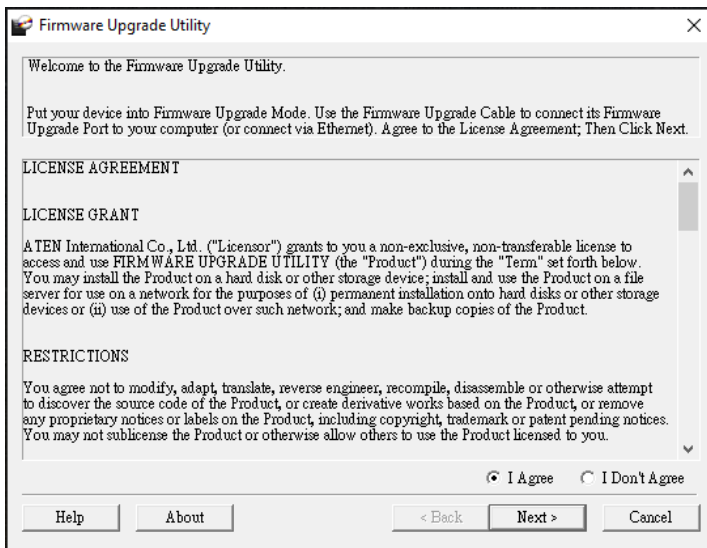

3. Click **Next**. The Firmware Upgrade Utility main screen appears:

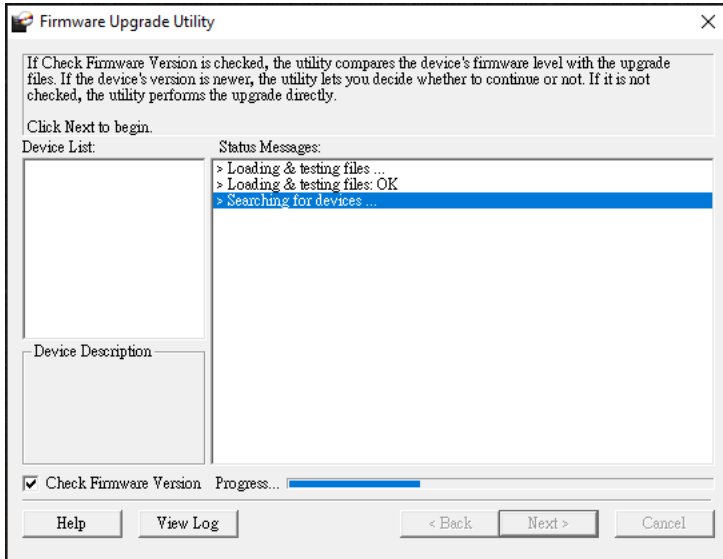

4. The Utility inspects your installation. All the devices capable of being upgraded by the package are listed in the *Select Master Device* list.

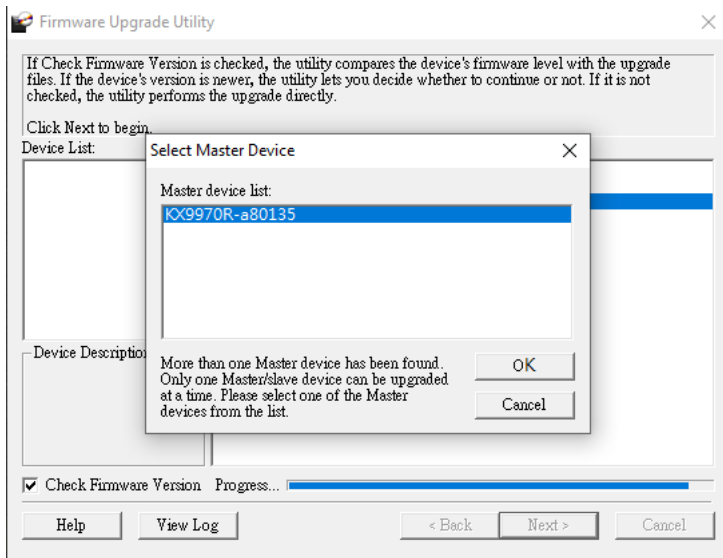

- After you have made your device selection, Click **OK** and then **Next** to begin the upgrade.

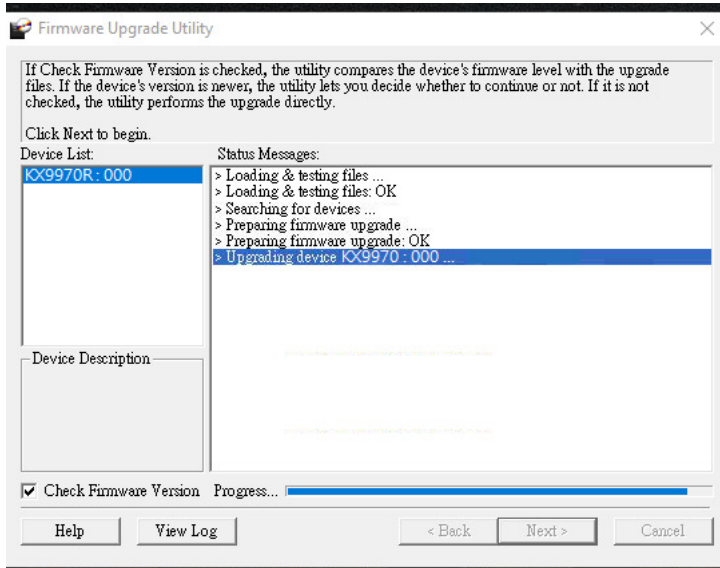

If you enabled *Check Firmware Version*, the Utility compares the device's firmware level with that of the upgrade files. If it finds that the device's version is higher than the upgrade version, it brings up a dialog box informing you of the situation and gives you the option to **Continue** or **Cancel**.

If you didn't enable *Check Firmware Version*, the Utility installs the upgrade files without checking whether they are a higher level, or not.

As the Upgrade proceeds status messages appear in the Status Messages panel, and the progress toward completion is shown on the *Progress* bar.

Upgrade Succeeded

After the upgrade has completed, a screen appears to inform you that the procedure was successful:

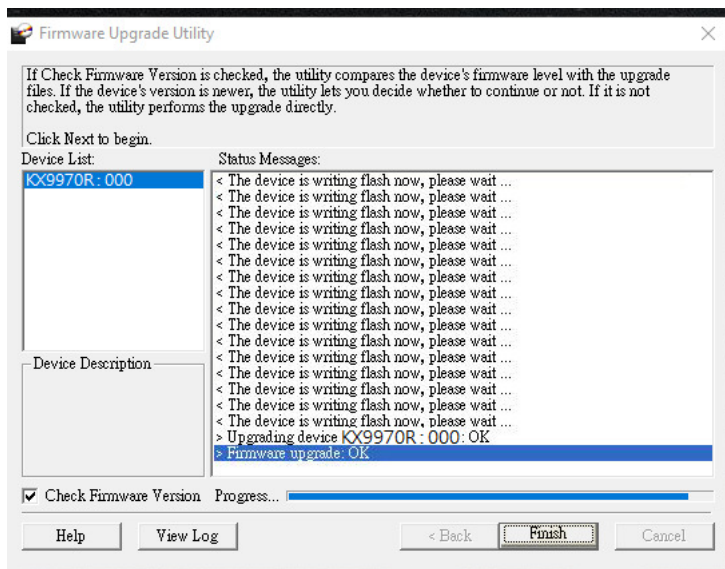

Firmware Upgrade Recovery

If the Upgrade Succeeded screen doesn't appear or the upgrade procedure is abnormally halted (due to computer crash, power failure, etc.), the device may become inoperable. If you find that the device does not work following a failed or interrupted upgrade, do the following

1. Power off the KX device.
2. Press the **Reset** button, then power on the KX device while holding Reset.
3. Hold **Reset** for 7 seconds after the device is powered on.
4. The device will revert to a previous firmware version and recover from the failure.
5. Upgrade the firmware to the most current version available.

Chapter 13

CLI Commands

Serial Control Protocol Commands

The KX Series's built-in bi-directional RS-232 serial interface and LAN port connection allows system control via Receivers through a high-end controller or PC. This control feature can also be accessed via TCP/IP through a computer running Telnet. The port for Telnet commands should be set to 9130.

Configuring the Serial Port

The controller's serial port should be configured the same as the Receiver's default configuration, as shown below:

| | |
|--------------|------|
| Baud Rate | 9600 |
| Data Bits | 8 |
| Parity | None |
| Stop Bits | 1 |
| Flow Control | None |

The Receiver's **Function Switch** should be set to *RS-232 Config* (see page 11). Before executing RS-232 commands across a network you must install the KVM over IP Matrix Manager on a computer and ensure that it is online.

On your computer, open a terminal (command line) session. Please press "Enter" or "T/t" to start "CLI Session" or "Text Menu".

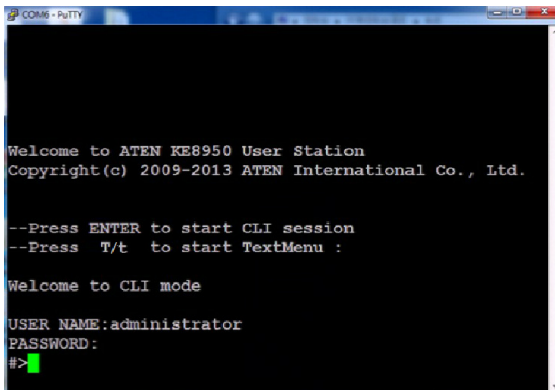

```
COM16 - PuTTY
Welcome to ATEN KE8950 User Station
Copyright(c) 2009-2013 ATEN International Co., Ltd.

--Press ENTER to start CLI session
--Press T/t to start TextMenu :

Welcome to CLI mode

USER NAME:administrator
PASSWORD:
#>
```

Device/Profile Commands

When typing a device or profile into a command string, you can enter the name by: **IP address** (device only), **ID** or **@** with the List number for the device/profile in the command line interface.

Note: To find out about the List number for a device/profile, execute a List command (page 202).

Telnet

The KX Series can be operated and configured via a remote terminal session using Telnet. This is a useful means for configuring devices when they are first setup and connected to the network.

To log into the KX Series device by means of a Telnet session, do the following:

1. On your computer, open a terminal (command line) session.
2. At the prompt, key in the KX device's IP address with port 9130 in the following way:
telnet [IP address] [port]
3. Press Enter. The login screen appears. At the login prompt, provide the Password.

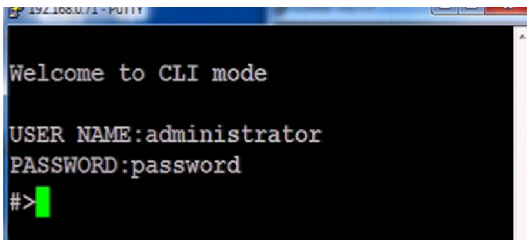
A screenshot of a terminal window titled "192.168.0.71 - PuTTY". The terminal displays the following text:

```
Welcome to CLI mode
USER NAME:administrator
PASSWORD:password
#>
```

A green cursor is visible after the prompt "#>".

Verification

After sending a command, a verification message appears at the end of the command line. Use the echo command to identify a command by number:

- ♦ **Command OK** - the command is correct and performed successfully
- ♦ **Command incorrect** - the command has the wrong format and/or values.
- ♦ **Echo Command** - at the end of a command string, type: **e1234** – where 1234 can be any number. The verification message returns with the echo number.

Switch Port Command

The formula for Switch Port commands is as follows:

Command + Output + Num1 + Input + Num2 + Mode + Stream + Connect + [Enter]

1. For example, if you want to switch the Receiver's connection to Transmitter (192.168.0.20), type the following:

sw i192.168.0.20 [Enter]

2. For example, if you want to disconnect the Receiver from its Transmitter connections, type the following:

sw off [Enter]

3. For example, if you want to connect Receiver (192.168.0.99) to Transmitter (192.168.0.79) with exclusive access to stream video and audio, type the following:

sw o192.168.0.99 i192.168.0.79 exclusive video audio on [Enter]

4. For example, to disconnect Receiver (192.168.0.11) from the video stream and return it to the OSD menu, type the following:

sw o192.168.0.11 off [Enter]

5. For example, to disconnect Receiver (192.168.0.09) from the video stream and logout the OSD, type the following:

sw o192.168.0.09 logout [Enter]

6. For example, to disconnect the Receiver's USB stream, type the following:

sw usb off [Enter]

7. For example, to switch the Receiver to the 5th Transmitter listed in the command line interface, type the following:

sw i@5 exclusive all on [Enter]

8. For example, to switch the Receiver to the 7th Transmitter listed in the command line interface with echo command 4312, type the following:

sw i@7 exclusive all on e4312

9. For example, to switch Receiver (192.168.0.12) to the 14th Transmitter listed in the command line interface with occupy access to stream video audio and USB, type the following:

sw o192.168.0.12 i@14 occupy video audio usb on [Enter]

The following tables show the possible values for the Switch Port commands:

| Command | Description |
|---------|---------------------|
| sw | Switch port command |

| Output | Description |
|--------|--------------------------|
| o | Output port command (RX) |

| Num1 | Description |
|------|---|
| xx | Output port xx: Receiver ID or IP address |
| @zz | List # zz: 1~99 To use the 4th Receiver listed in the command line interface, type: o@4 |

| Input | Description |
|-------|--------------------|
| i | Input command (TX) |

| Num2 | Description |
|------|--|
| yy | Input port yy: Transmitter ID or IP address |
| @zz | List # zz: 1~99 To use the 8th Transmitter listed in the command line interface, type: i@8 |

| Mode | Description |
|-----------|--|
| exclusive | Sets the Access Mode to exclusive. |
| share | Sets the Access Mode to share. |
| occupy | Sets the Access Mode to occupy. |
| viewonly | Sets the Access Mode to view only. If the mode is omitted, view only is used by default. |

| Stream | Description |
|--------|-------------------------------|
| video | Sets the video source stream |
| audio | Sets the audio source stream |
| serial | Sets the serial source stream |

| Stream | Description |
|--------|----------------------------|
| usb | Sets the USB source stream |
| all | Sets all source streams |

| Connect | Description |
|---------|-------------|
| on | Connect |
| off | Disconnect |
| logout | Logout OSD |

The following table lists the available Switch Port commands:

| Command | Output | Num1 | Input | Num2 | Mode | Stream | Connect | Description |
|---------|--------|------|-------|------|-----------|--|---------|---|
| sw | o | xx | i | yy | exclusive | video audio serial usb all | on | Switch output xx to input yy with exclusive access to source(s). xx: Receiver ID yy: Transmitter ID |
| sw | o | xx | i | yy | share | video audio serial usb all | on | Switch output xx to input yy with share access to stream source(s). xx: Receiver ID yy: Transmitter ID |
| sw | o | xx | i | yy | occupy | video audio serial usb all | on | Switch output xx to input yy with occupy access to stream source(s). xx: Receiver ID yy: Transmitter ID |
| sw | o | xx | i | yy | viewonly | video audio serial usb all | on | Switch output xx to input yy with viewonly access to stream source(s). xx: Receiver ID yy: Transmitter ID |
| sw | o | xx | | | | | off | Switch output xx, disconnect streams, return to OSD menu. xx: Receiver ID |
| sw | o | xx | | | | | logout | Switch output xx, disconnect streams and logout from OSD menu. xx: Receiver ID |
| sw | | | | | | video audio serial usb all | off | Switch Receiver stream(s) to disconnect. |

| Command | Output | Num1 | Input | Num2 | Mode | Stream | Connect | Description |
|---------|--------|------|-------|------|--|--|---------|--|
| sw | | | | | | | off | Switch Receiver disconnect streams, return to OSD menu. |
| sw | | | i | @zz | exclusive share occupy viewonly | video audio serial usb all | on | Switch Receiver to input @zz with [mode] access to stream source(s). zz: Transmitter # by order listed in the command line interface. |
| sw | o | xx | i | @zz | exclusive | video audio serial usb all | on | Switch output xx to input @zz with [mode] access to stream source(s). xx: Receiver ID zz: Transmitter # by order listed in command line interface. |

- Note:**
1. Each command string can be separated with a space.
 2. The **Mode** command string can be skipped and **view only** will be used by default.
 3. Skip the **Output** and **Num1** command strings to configure the local Receiver.

Mute Command

The Mute command allows you to enable or disable the audio.

The formula for the Mute command is as follows:

Command + Output + Num1 + Control + [Enter]

1. For example, to turn mute off (audio on) for the Receiver, type the following:

mute off [Enter]

2. For example, to turn mute on for Receiver (192.168.0.11), type the following:

mute o192.168.0.11 on [Enter]

3. For example, to turn mute off for Receiver (192.168.0.18), type the following:

mute o192.168.0.18 off [Enter]

The following tables show the possible values for the Mute commands:

| Command | Description |
|---------|--|
| mute | Mute command |
| Output | Description |
| o | Output port command |
| Num1 | Description |
| xx | Output number xx: Receiver ID or IP address |
| Control | Description |
| on | Mute on; audio disabled |
| off | Mute off; audio enabled (default) |

The following table lists the available Mute commands:

| Command | Output | Num1 | Control | Description |
|---------|--------|------|---------|--|
| mute | o | xx | on | Turn mute on for output xx xx: Receiver ID |
| mute | o | xx | off | Turn mute off for output xx xx: Receiver ID |

| Command | Output | Num1 | Control | Description |
|---------|--------|------|---------|----------------------------|
| mute | | | on | Turn mute on for Receiver |
| mute | | | off | Turn mute off for Receiver |

- Note:**
1. Each command string can be separated with a space.
 2. The **Control** command string can be skipped and **off** will be used by default.
 3. Skip the **Output** and **Num1** command strings to configure the local Receiver.
-

Profile Command

The Profile command allows you to connect profiles and video walls.

The formula for Profile commands is as follows:

Command + Profile + Num1 + Control + [Enter]

1. For example, to connect profile 8 and lock the OSD menu, type the following:

profile f8 [Enter]

2. For example, to connect profile 4 with access to the OSD menu, type the following:

profile f4 release [Enter]

3. For example, to disconnect profile 12 and return to the Receiver to the OSD menu, type the following:

profile f12 back [Enter]

The following tables show the possible values for the Profile commands:

| Command | Description |
|----------------|--------------------|
| profile | Profile command |

| Profile | Description |
|----------------|--------------------|
| f | Profile ID |

| Num1 | Description |
|-------------|--------------------------------------|
| xx | Profile or Video Wall ID xx: 1-99 |

| Control | Description |
|----------------|--|
| lock | Connect profile, lock access to OSD menu (default) |
| release | Connect profile, allow access to OSD menu |
| back | Disconnect profile, return Receiver to OSD menu |

The following table lists the available Profile commands:

| Command | Profile | Num1 | Control | Description |
|---------|---------|------|---------|---|
| profile | f | xx | lock | Connect profile xx, lock OSD access xx: 1~99 |
| profile | f | xx | release | Connect profile xx, allow OSD access xx: 1~99 |
| profile | f | xx | back | Disconnect profile xx and return Receiver to OSD menu xx: 1~99 |

-
- Note:**
1. Each command string can be separated with a space.
 2. The **Control** command string can be skipped and **lock** will be used by default.
 3. For functional **lock** and **release** commands, make sure the **Lock OSD when connecting** option is checked during *Create Profile*. Refer to *Lock OSD*, page 131 for more information.
-

EDID Command

Extended Display Identification Data (EDID) is a data that contains a display's basic information and is used to communicate with the video source. The EDID commands allow you to change the EDID setting of a Transmitter. For more information on configuring EDID settings, see *Properties*, page 47.

The formula for the EDID command is as follows:

Command + Address + Number + Control + [Enter]

1. For example, if you want to configure device (192.168.0.3) to use the remix EDID mode, type the following:

edid a192.168.0.3 remix [Enter]

The following tables show the possible values for the EDID commands:

| Command | Description |
|---------|---|
| edid | EDID command |
| Address | Description |
| a | Address command |
| Number | Description |
| xx | Address number xx: Receiver ID or IP address |
| Control | Description |
| auto | Checks the EDID of all connected displays and the ATEN default EDID to use the best common resolution for all displays. |
| remix | Manually checks the EDID of all connected displays and the ATEN default EDID to use the best common resolution for all displays (see <i>EDID Mode</i> , page 55). |
| default | Implements ATEN's default EDID. (default) |
| manual | Manually set the EDID configuration from the Receiver's OSD (see <i>EDID Mode</i> , page 55). |

The following table lists the available EDID commands:

| Command | Address | Number | Control | Enter | Description |
|----------------|----------------|---------------|----------------|--------------|---|
| edid | a | xx | auto | [Enter] | Set EDID of address xx to auto. xx: Device ID or IP Address |
| edid | a | xx | remix | [Enter] | Set EDID of address xx to remix. xx: Device ID or IP Address |
| edid | a | xx | default | [Enter] | Set EDID of address xx to default. xx: Device ID or IP Address |
| edid | a | xx | manual | [Enter] | Set EDID of address xx to manual. xx: Device ID or IP Address |

Reset Command

The Reset command allows you to reset a device back to the default factory settings. Reset includes resetting the devices IP address.

Note: The Reset command resets everything but the login information to the factory default settings. To reset the login information, refer to *Reset All Information* on page 233.

The formula for the Reset command is as follows:

Command + Address + Number + [Enter]

- For example, to reset device (192.168.0.95), type the following:
reset a192.168.0.95 [Enter]
- For example, to reset the Receiver, type the following:
reset [Enter]

The following tables show the possible values for the **Reset** command:

| Command | Description |
|---------|---|
| reset | Reset command |
| Address | Description |
| a | Address command |
| Number | Description |
| xx | Address number xx: Receiver ID or IP address |

The following table lists the available Reset commands:

| Command | Address | Num | Enter | Description |
|---------|---------|-----|---------|--|
| reset | a | xx | [Enter] | Reset address xx back to the factory default settings xx: Device ID or IP Address |
| reset | | | [Enter] | Resets the Receiver settings |

Note: 1. Each command string can be separated with a space.

- Skip the **Address** and **Number** command strings to reset the local Receiver.

RS-232 Command

The RS-232 command allows you to set the RS-232 settings for a device.

The formula for the RS-232 command is as follows:

Command + Address + Number + Baud Rate + Parity + Data Bit + Stop Bit + Flow Control [Enter]

1. For example, to set device (192.168.0.33) with a baud rate of 38400, parity of none, data bit of 8, and stop bit of 1, type the following:

baud a192.168.0.33 38400 none 8 1 [Enter]

2. For example, to set the local device with a baud rate of 19200, type the following:

baud 19200 [Enter]

The following tables show the possible values for the RS-232 command:

| Command | Description |
|------------------|---|
| baud | RS-232 command |
| Address | Description |
| a | Address command |
| Num1 | Description |
| xx | Address number xx: Device ID or IP address |
| Baud Rate | Description |
| 9600 | Use 9600 baud rate |
| 19200 | Use 19200 baud rate |
| 38400 | Use 38400 baud rate |
| 115200 | Use 115200 baud rate |
| Parity | Description |
| None | Sets the parity to none |
| Even | Sets the parity to even |
| Odd | Sets the parity to odd |
| Data Bit | Description |
| 5 | Sets the data bit to 5 |
| 6 | Sets the data bit to 6 |

| Data Bit | Description |
|--------------|-------------------------------|
| 7 | Sets the data bit to 7 |
| 8 | Sets the data bit to 8 |
| Stop Bit | Description |
| 1 | Sets the stop bit to 1 |
| 2 | Sets the stop bit to 2 |
| Flow Control | Description |
| None | Sets flow control to none |
| Hardware | Sets flow control to hardware |
| Xon | Sets flow control to Xon |
| Xoff | Sets flow control to Xoff |

The following table lists the available Baud Rate commands:

| Com mand | Address | Num 1 | Baud Rate | Parity | Data Bit | Stop Bit | Flow Control | Description |
|-------------|---------|----------|--------------|---------------------|------------------|-------------|------------------------------|---|
| baud | a | xx | 9600 | None Even Odd | 5 6 7 8 | 1 2 | None Hardware Xon/Xoff | Set address xx baud rate to 9600, with parity/ data bit/ stop bit / flow control setting |
| baud | a | xx | 19200 | None Even Odd | 5 6 7 8 | 1 2 | None Hardware Xon/Xoff | Set address xx baud rate to 19200, with parity/ data bit/ stop bit / flow control setting |
| baud | a | xx | 38400 | None Even Odd | 5 6 7 8 | 1 2 | None Hardware Xon/Xoff | Set address xx baud rate to 38400, with parity/ data bit/ stop bit / flow control setting |
| baud | a | xx | 115200 | None Even Odd | 5 6 7 8 | 1 2 | None Hardware Xon/Xoff | Set address xx baud rate to 115200, with parity/ data bit/ stop bit / flow control setting |

| Com mand | Address | Num 1 | Baud Rate | Parity | Data Bit | Stop Bit | Flow Control | Description |
|-------------|---------|----------|--------------|--------|-------------|-------------|-----------------|--|
| baud | | | 9600 | | | | | Set local device baud rate to 9600 |
| baud | | | 19200 | | | | | Set local device baud rate to 19200 |
| baud | | | 38400 | | | | | Set local device baud rate to 38400 |
| baud | | | 115200 | | | | | Set local device baud rate to 115200 |

- Note:** 1. Each command string can be separated with a space.
2. The **Baud Rate** value is required but **Parity**, **Data Bit** and **Stop Bit** can be skipped and their setting will not change.
 3. Skip the **Address** and **Number** command strings to configure the local device settings.
-

OSD Command

To enable or disable the On-Screen Display (OSD) menu for a Receiver, use the following command:

Command + Output + Number + Control + [Enter]

1. For example, to enable the OSD for Receiver 192.168.0.51, type:
osd o192.168.0.51 on [Enter]
2. For example, to disable the OSD for the local Receiver, type:
osd off [Enter]

The following tables show the possible values for the OSD command:

| Command | Description |
|---------|--|
| osd | OSD command |
| Output | Description |
| o | Output command |
| Number | Description |
| xx | Output number xx: Receiver ID or IP address |
| Control | Description |
| on | Enable OSD functions |
| off | Disable OSD functions (default) |

The following table lists the available OSD commands:

| Command | Output | Number | Control | Enter | Description |
|---------|--------|--------|---------|---------|--|
| osd | o | xx | on | [Enter] | Enable OSD functions for output xx xx: Receiver ID or IP address |
| osd | o | xx | off | [Enter] | Disable OSD functions for output xx off (default) xx: Receiver ID or IP address |

Note: 1. Each command string can be separated with a space.

2. Skip the **Output** and **Number** command strings to configure the local Receiver.

List Command

The List command allows you to retrieve information about users, settings and connections.

The formula for the List command is as follows:

Command + Output + Input + Number + Control [Enter]

1. For example, for a complete list of available channels, type the following:
list channel [Enter]
2. For example, for a complete list of available profiles, type the following:
list profile [Enter]
3. For example, to list all users logged into all OSD menus, type the following:
4. **list login [Enter]**
5. For example, to list the user logged into the OSD on Receiver (192.168.0.44), type the following:
list o192.168.0.44 login [Enter]
6. For example, for a complete list of available connections, type the following:
list connection [Enter]
7. For example, to list the current connections on Transmitter (192.168.0.88), type the following:
list i192.168.0.88 connection [Enter]

The following tables show the possible values for the List command:

| Command | Description |
|---------|--------------|
| list | List command |

| Output | Description |
|--------|----------------|
| o | Output command |

| Input | Description |
|-------|---------------|
| i | Input command |

| Number | Description |
|--------|---|
| xx | Output or Input number xx: Device ID or IP address |

| Control | Description |
|------------|---|
| channel | Lists information about the available channel(s) |
| profile | Lists information about the available profile and TV wall connections |
| rx | Lists information about the Receiver |
| login | Lists information about users logged into to the OSD menu |
| connection | Lists information about a Transmitters current connections |

The following table lists the available List commands:

| Command | Output | Input | Number | Control | Description |
|---------|--------|-------|--------|------------|--|
| list | o | | xx | login | List output xx user logged into OSD. |
| list | o | | xx | rx | List output xx Receiver information |
| list | | i | xx | connection | List input xx Transmitter information |
| list | | | | channel | List all available channel information |
| list | | | | profile | List all available profile information |
| list | | | | rx | List information about all Receivers |
| list | | | | login | List information about all OSD logins |
| list | | | | connection | List information about all connections |

Note: 1. Each command string can be separated with a space.

2. Skip the **Output** or **Input** and **Number** command strings to view the local Receiver.

Read Command

The Read command allows you to retrieve the properties of a device.

The formula for the Read command is as follows:

Command + Output + Input + Number + Control [Enter]

1. For example, to read all of the local Receiver's properties, type the following:
read all [Enter]
2. For example, to read all of Receiver (192.168.0.19) device properties, type the following:
read o192.168.0.19 all [Enter]
3. For example, to read all of Transmitter (192.168.0.28) device properties, type the following:
read i192.168.0.28 all [Enter]
4. For example, to read the basic properties of Receiver (192.168.0.61), type the following:
read o192.168.0.61 basic [Enter]
5. For example, to read the network properties of Transmitter (192.168.0.71), type the following:
read i192.168.0.71 network [Enter]

The following tables show the possible values for the Read command:

| Command | Description |
|----------------|--------------------|
| read | Read command |

| Output | Description |
|---------------|--------------------|
| o | Output command |

| Input | Description |
|--------------|--------------------|
| i | Input command |

| Number | Description |
|---------------|---|
| xx | Output or Input number xx: Device ID or IP address |

| Control | Description |
|----------------|----------------------------|
| all | Read all device properties |

| Control | Description |
|-----------------|--|
| basic | Read basic properties |
| network | Read network properties |
| ipsettings | Read IP settings |
| rs232 | Read RS232 properties |
| properties | Read connection properties |
| manager | Read KVM over IP Matrix Manager properties |
| streams | Read enable media properties |
| tx | Read source stream IP properties (Receiver) |
| usbmode | Read USB mode properties (Receiver) |
| multicast | Read multicast properties (Transmitter) |
| videoqyadvanced | Read advanced video properties (Transmitter) |
| ossettings | Read OS properties (Transmitter) |

The following table lists the available Read commands:

| Command | Output | Input | Number | Control | Description |
|---------|--------|-------|--------|------------|--|
| read | o | i | xx | all | Read output or input xx all device properties xx: Device ID or IP address |
| read | o | i | xx | basic | Read output or input xx basic properties xx: Device ID or IP address |
| read | o | i | xx | network | Read output or input xx network properties xx: Device ID or IP address |
| read | o | i | xx | ipsettings | Read output or input xx IP address properties xx: Device ID or IP address |

| Command | Output | Input | Number | Control | Description |
|---------|--------|-------|--------|------------------|--|
| read | o | i | xx | rs232 | Read output or input xx RS-232 properties xx: Device ID or IP address |
| read | o | i | xx | properties | Read output or input xx connection properties xx: Device ID or IP address |
| read | o | i | xx | manager | Read output or input xx KVM over IP Matrix Manager IP and port properties xx: Device ID or IP address |
| read | o | i | xx | streams | Read output or input xx enable media properties xx: Device ID or IP address |
| read | o | | xx | tx | Read output xx source stream IP address properties xx: Receiver ID or IP address |
| read | o | | xx | usbmode | Read output xx USB mode properties xx: Receiver ID or IP address |
| read | i | | xx | multicast | Read input xx multicast properties xx: Transmitter ID or IP address |
| read | i | | xx | videoqtyadvanced | Read input xx advanced video properties xx: Transmitter ID or IP address |
| read | i | | xx | ossettings | Read input xx OS properties xx: Transmitter ID or IP address |
| read | | | | all | Read all properties of local Receiver |

| Command | Output | Input | Number | Control | Description |
|---------|--------|-------|--------|--|---|
| read | | | | basic network ipsettings rs232 properties manager streams tx usbmode | Read [control] properties of local Receiver. |

Note: 1. Each command string can be separated with a space.

2. Skip the **Output** or **Input** and **Number** command strings to read the local Receiver properties.
-

Set Command

The Set command allows you to configure the properties of a device. Some settings require that both the device and KVM over IP Matrix Manager are online or the command will fail.

The formula for the Set command is as follows:

Command + Output + Input + Number + Control + Value + [Enter]

1. For example, to set the name of the local Receiver to KX9970TX1, type the following:

set Name=KX9970TX1 [Enter]

2. For example, to set the description of Transmitter (192.168.0.33) to KX Room B, type the following:

set o192.168.0.19 Description=KX Room B [Enter]

3. For example, to set the DHCP settings of Transmitter (192.168.0.28) to static, type the following:

set i192.168.0.28 dhcpFlag=STATIC [Enter]

4. For example, to set the IP settings of the local Receiver to 192.168.0.2, type the following:

set ipAddr=192.168.0.2 [Enter]

5. For example, to set the Transmitter Video IP setting to 192.168.0.44 for Receiver (192.168.0.56), type the following:

set o192.168.0.56 TxVideoIP=192.168.0.44 [Enter]

The following tables show the possible values for the Set command:

| Command | Description |
|----------------|--------------------|
| set | Set command |

| Output | Description |
|---------------|--------------------|
| o | Output command |

| Input | Description |
|--------------|--------------------|
| i | Input command |

| Number | Description |
|---------------|---|
| xx | Output or Input number xx: Device ID or IP address |

| Control | Description |
|-----------------|---|
| Name | Sets the device name |
| Description | Sets the device description |
| ipInstallerFlag | Sets the IP installer option |
| dhcpFlag | Sets the DHCP setting |
| ipAddr | Sets the IP address |
| netmask | Sets the subnet mask |
| gw | Sets the default gateway |
| modeFlag | Sets the device mode |
| BaudRate | Sets the baud rate setting |
| Parity | Sets the parity setting |
| DataBit | Sets the data bit setting |
| StopBit | Sets the stop bit setting |
| FlowCtrl | Sets the flow control setting |
| TxVideoIP | Sets the Transmitter video IP setting |
| TxAudioIP | Sets the Transmitter audio IP setting |
| TxUSBIP | Sets the Transmitter USB IP setting |
| TxRSIP | Sets the Transmitter RS-232 IP setting |
| VideoEnFlag | Sets the (enable media) video source stream |
| AudioEnFlag | Sets the (enable media) audio source stream |
| USBEnFlag | Sets the (enable media) USB source stream |
| RSEnFlag | Sets the (enable media) RS232 source stream |
| ManagerIP | Sets the KVM over IP Matrix Manager IP |
| ManagerPort | Sets the KVM over IP Matrix Manager port |
| Beeper | Sets the beeper |
| RxVM | Sets the USB mode setting |
| USBSecure | Sets the USB encryption |
| PortOS | Sets the port OS setting |
| OSLanguage | Sets the OS language |
| videoMCastEn | Sets the enable multicast video setting |

| Control | Description |
|----------------|---|
| audioMCastEn | Sets the enable multicast audio setting |
| Edid | Sets the EDID mode selection setting |
| VideoType | Sets the video type setting |
| ColorDepth | Sets the color depth setting |
| BandwidthLimit | Sets the bandwidth limit setting |
| VideoQty | Sets the video quality setting |
| BGRefresh | Sets the background refresh setting |
| Beeper | Sets the beeper setting |
| OccupyTimeout | Sets the occupy timeout setting |
| Resolution | Sets the resolution setting |

| Value | Description |
|-------|---|
| =yy | Set value to yy yy: Enter a value that corresponds to the control being used |

The following table lists the available Set commands:

| Command | Output | Input | Number | Control | Value | Description |
|---------|--------|-------|--------|-----------------|-------|---|
| Set | o | i | xx | Name | yy | Set output or input xx Name to yy xx: Device ID or IP address yy: Name value |
| Set | o | i | xx | Description | yy | Set output or input xx Description to yy xx: Device ID or IP address yy: Description value |
| Set | o | i | xx | ipInstallerFlag | yy | Set output or input xx ipInstallerFlag to yy xx: Device ID or IP address yy: enable, viewonly, disable |

| Command | Output | Input | Number | Control | Value | Description |
|---------|--------|-------|--------|----------|-------|--|
| Set | o | i | xx | dhcpFlag | yy | Set output or input xx dhcpFlag to yy xx: Device ID or IP address yy: dhcp, static |
| Set | o | i | xx | ipAddr | yy | Set output or input xx ipAddr to yy xx: Device ID or IP address yy: IP address value |
| Set | o | i | xx | netmask | yy | Set output or input xx netmask to yy xx: Device ID or IP address yy: Subnet mask value |
| Set | o | i | xx | gw | yy | Set output or input xx gw to yy xx: Device ID or IP address yy: Default gateway value |
| Set | o | i | xx | modeFlag | yy | Set output or input xx modeFlag to yy xx: Device ID or IP address yy: extender, matrix |
| Set | o | i | xx | BaudRate | yy | Set output or input xx BaudRate to yy xx: Device ID or IP address yy: 9600, 19200, 38400, 115200 |
| Set | o | i | xx | Parity | yy | Set output or input xx Parity to yy xx: Device ID or IP address yy: none, even, odd |
| Set | o | i | xx | DataBit | yy | Set output or input xx DataBit to yy xx: Device ID or IP address yy: 5, 6, 7, 8 |

| Command | Output | Input | Number | Control | Value | Description |
|---------|--------|-------|--------|-------------|-------|---|
| Set | o | i | xx | StopBit | yy | Set output or input xx StopBit to yy xx: Device ID or IP address yy: 1, 1.5, 2 |
| Set | o | i | xx | FlowCtrl | yy | Set output or input xx FlowCtrl to yy xx: Device ID or IP address yy: none, hardware, Xon, Xoff |
| Set | o | i | xx | TxVideoIP | yy | Set output xx TxVideoIP to yy xx: Device ID or IP address yy: IP address value |
| Set | o | | xx | TxAudioIP | yy | Set output xx TxAudioIP to yy xx: Device ID or IP address yy: IP address value |
| Set | o | | xx | TxUSBIP | yy | Set output xx TxUSBIP to yy xx: Device ID or IP address yy: IP address value |
| Set | o | | xx | TxRSIP | yy | Set output xx TxRSIP to yy xx: Device ID or IP address yy: IP address value |
| Set | o | i | xx | VideoEnFlag | yy | Set output or input xx VideoEnFlag to yy xx: Device ID or IP address yy: enable, disable |
| Set | o | i | xx | AudioEnFlag | yy | Set output or input xx AudioEnFlag to yy xx: Device ID or IP address yy: enable, disable |

| Comm and | Output | Input | Number | Control | Value | Description |
|----------|--------|-------|--------|-------------|-------|--|
| Set | o | i | xx | USBEnFlag | yy | Set output or input xx USBEnFlag to yy xx: Device ID or IP address yy: enable, disable |
| Set | o | i | xx | RSEnFlag | yy | Set output or input xx RSEnFlag to yy xx: Device ID or IP address yy: enable, disable |
| Set | o | i | xx | ManagerIP | yy | Set output or input xx ManagerIP to yy xx: Device ID or IP address yy: KVM over IP Matrix Manager IP address |
| Set | o | i | xx | ManagerPort | yy | Set output or input xx ManagerPort to yy xx: Device ID or IP address yy: KVM over IP Matrix Manager port |
| Set | o | i | xx | Beeper | yy | Set output or input xx Beeper to yy xx: Device ID or IP address yy: enable, disable |
| Set | o | | xx | RxVM | yy | Set output xx RxVM to yy xx: Device ID or IP address yy: vm, vusb |
| Set | o | | xx | USBSecure | yy | Set output xx USBSecure to yy xx: Device ID or IP address yy: on, off |
| Set | | i | xx | PortOS | yy | Set input xx PortOS to yy xx: Device ID or IP address yy: win, mac, sun, other |

| Comm and | Output | Input | Number | Control | Value | Description |
|----------|--------|-------|--------|--------------|-------|---|
| Set | | i | xx | OSLanguage | yy | Set input xx OSLanguage to yy xx: Device ID or IP address yy: english, japanese, french, german, spanish, korean, chinese(traditional), english(uk), swedish, arabic, belgian, canadian-bilingual, french(canada), czech, danish, finnish, greek, hebrew, hungarian, international(iso), italian, latin american, dutch, norwegian, persian(farsi), polish, portuguese, russian, slovak, french (switzerland), german (switzerland), switzerland, reserved, turkish-q, reserved, serbo-croatian |
| Set | | i | xx | videoMCastEn | yy | Set input xx videoMCastEn to yy xx: Device ID or IP address yy: enable, disable |
| Set | | i | xx | audioMCastEn | yy | Set input xx audioMCastEn to yy xx: Device ID or IP address yy: enable, disable |
| Set | | i | xx | Edid | yy | Set input xx Edid to yy xx: Device ID or IP address yy: default, auto, manual, remix |
| Set | | i | xx | VideoType | yy | Set input xx VideoType to yy xx: Device ID or IP address yy: dvi-d, dvi-a |

| Command | Output | Input | Number | Control | Value | Description |
|---------|--------|-------|--------|----------------|-------|--|
| Set | | i | xx | ColorDepth | yy | Set input xx ColorDepth to yy xx: Device ID or IP address yy: 8, 16, 24, and 36 |
| Set | | i | xx | BandwidthLimit | yy | Set input xx BandwidthLimit to yy xx: Device ID or IP address yy: unlimited, 100, 200, 500 |
| Set | | i | xx | VideoQty | yy | Set input xx VideoQty to yy xx: Device ID or IP address yy: 1, 2, 3, 4, 5 |
| Set | | i | xx | BGRefresh | yy | Set input xx BGRefresh to yy xx: Device ID or IP address yy: off, 16, 32, 64, 128, 256 |
| Set | | i | xx | OccupyTimeout | yy | Set input xx OccupyTimeout to yy xx: Device ID or IP address yy: 1~240 |
| Set | | i | xx | Resolution | yy | Set input xx Resolution to yy xx: Device ID or IP address yy: 1920x1200, 1920x1080, 1680x1050, 1600x1200, 1600x900, 1440x900, 1400x1050, 1366x768, 1280x1024, 1280x960, 1280x720, 1152x864, 1024x768, 800x600, 720x400, 640x480, 2560x1080, 3840x2160, 1920x1440, 2560x1600, 2560x1440, 2048x1536, 5120x2880 |

This Page Intentionally Left Blank

Safety Instructions

General

- ◆ This product is for indoor use only.
- ◆ Read all of these instructions. Save them for future reference.
- ◆ Follow all warnings and instructions marked on the device.
- ◆ Do not place the device on any unstable surface (cart, stand, table, etc.). If the device falls, serious damage will result.
- ◆ Do not use the device near water.
- ◆ Do not place the device near, or over, radiators or heat registers.
- ◆ The device cabinet is provided with slots and openings to allow for adequate ventilation. To ensure reliable operation, and to protect against overheating, these openings must never be blocked or covered.
- ◆ The device should never be placed on a soft surface (bed, sofa, rug, etc.) as this will block its ventilation openings. Likewise, the device should not be placed in a built in enclosure unless adequate ventilation has been provided.
- ◆ Never spill liquid of any kind on the device.
- ◆ Avoid circuit overloads. Before connecting equipment to a circuit, know the power supply's limit and never exceed it. Always review the electrical specifications of a circuit to ensure that you are not creating a dangerous condition or that one doesn't already exist. Circuit overloads can cause a fire and destroy equipment.
- ◆ Unplug the device from the wall outlet before cleaning. Do not use liquid or aerosol cleaners. Use a damp cloth for cleaning.
- ◆ The device should be operated from the type of power source indicated on the marking label. If you are not sure of the type of power available, consult your dealer or local power company.
- ◆ To prevent damage to your installation it is important that all devices are properly grounded.
- ◆ Do not allow anything to rest on the power cord or cables. Route the power cord and cables so that they cannot be stepped on or tripped over.
- ◆ Position system cables and power cables carefully; Be sure that nothing rests on any cables.

- ◆ Never push objects of any kind into or through cabinet slots. They may touch dangerous voltage points or short out parts resulting in a risk of fire or electrical shock.
- ◆ Do not attempt to service the device yourself. Refer all servicing to qualified service personnel.
- ◆ If the following conditions occur, unplug the device from the wall outlet and bring it to qualified service personnel for repair.
 - ◆ The power cord or plug has become damaged or frayed.
 - ◆ Liquid has been spilled into the device.
 - ◆ The device has been exposed to rain or water.
 - ◆ The device has been dropped, or the cabinet has been damaged.
 - ◆ The device exhibits a distinct change in performance, indicating a need for service.
 - ◆ The device does not operate normally when the operating instructions are followed.
- ◆ Only adjust those controls that are covered in the operating instructions. Improper adjustment of other controls may result in damage that will require extensive work by a qualified technician to repair.

Rack Mount

- ◆ Before working on the rack, make sure that the stabilizers are secured to the rack, extended to the floor, and that the full weight of the rack rests on the floor. Install front and side stabilizers on a single rack or front stabilizers for joined multiple racks before working on the rack.
- ◆ Always load the rack from the bottom up, and load the heaviest item in the rack first.
- ◆ Make sure that the rack is level and stable before extending a device from the rack.
- ◆ Use caution when pressing the device rail release latches and sliding a device into or out of a rack; the slide rails can pinch your fingers.
- ◆ After a device is inserted into the rack, carefully extend the rail into a locking position, and then slide the device into the rack.
- ◆ Do not overload the AC supply branch circuit that provides power to the rack. The total rack load should not exceed 80 percent of the branch circuit rating.
- ◆ Make sure that all equipment used on the rack – including power strips and other electrical connectors – is properly grounded.
- ◆ Ensure that proper airflow is provided to devices in the rack.
- ◆ Ensure that the operating ambient temperature of the rack environment does not exceed the maximum ambient temperature specified for the equipment by the manufacturer.
- ◆ Do not step on or stand on any device when servicing other devices in a rack.

Technical Support

International

- ◆ For online technical support – including troubleshooting, documentation, and software updates: **<http://support.aten.com>**
- ◆ For telephone support, see *Telephone Support*, page iv.

North America

| | | |
|--------------------------|--|---|
| Email Support | | support@aten-usa.com |
| Online Technical Support | Troubleshooting Documentation Software Updates | http://www.aten-usa.com/support |
| Telephone Support | | 1-888-999-ATEN ext 4988 1-949-428-1111 |

When you contact us, please have the following information ready beforehand:

- ◆ Product model number, serial number, and date of purchase.
- ◆ Your computer configuration, including operating system, revision level, expansion cards, and software.
- ◆ Any error messages displayed at the time the error occurred.
- ◆ The sequence of operations that led up to the error.
- ◆ Any other information you feel may be of help.

Specifications

KX9970T / KX9970FT

| Function | | KX9970T | KX9970FT | |
|-------------------|-------------------------|---|-------------------------------------|---------------|
| Connectors | Console Ports | Keyboard | 1 x USB Type A Female (White) | |
| | | Video | 1 x DisplayPort Female (Black) | |
| | | Mouse | 1 x USB Type A Female (White) | |
| | | Speaker | 1 x Mini Stereo Jack Female (Green) | |
| | | Mic. | 1 x Mini Stereo Jack Female (Pink) | |
| | | RS-232 | 1 x DB-9 Male (Black) | |
| | KVM Ports | KB / Mouse | USB Type B Female (White) | |
| | | Speaker | 1 x Mini Stereo Jack (Green) | |
| | | Mic. | 1 x Mini Stereo Jack (Pink) | |
| | | Video | 1 x DisplayPort Female (Black) | |
| | | RS-232 | 1 x DB-9 Female (Black) | |
| | Power | | 2 x DC Jack (Black) | |
| | LAN | | 1 x RJ-45 (Black) 2 x SFP+ Slot | 2 x SFP+ Slot |
| | Control | | 1 x PS/2 Female (Purple) | |
| Switches | Function | 1 x Slide switch (Black) (Auto, RS-232 Config, Local) | | |
| | OSD | 1 x Pushbutton | | |
| | Port (Up) | 1 x Pushbutton | | |
| | Port (Down) | 1 x Pushbutton | | |
| | Reset | 1 x Semi-recessed Pushbutton | | |
| LEDs | LAN (1000 / 10000 Mbps) | 1 x (1000: Orange / 10000: Green) | | |
| | Power | 2 x Green | | |
| | Local | 1 x Green | | |
| | Remote | 1 x Green | | |
| Emulation | Keyboard / Mouse | USB | | |
| Power Consumption | | DC12V;18.88W;108 BTU | DC12V;17.99W;104 BTU | |
| Video Resolution | | Up to 5120 x 2880 @ 30 Hz, 5120 x 1440 @ 60 Hz, 4096 x 2160 @ 60 Hz (4:4:4), 2560 x 1440 @ 144 Hz, 1920 x 1080 @ 240 Hz | | |

| Function | | KX9970T | KX9970FT |
|---------------------|---------------------------|--|----------|
| Environment | Operating Temp. | 0 – 50 °C | |
| | Storage Temp. | -20 – 60 °C | |
| | Humidity | 0–95% RH, Non-condensing | |
| Physical Properties | Housing | Metal | |
| | Weight | 1.10 kg (2.42 lb) | |
| | Dimensions (L x W x H) | 21.50 x 16.30 x 4.20 cm (8.46 x 6.42 x 1.65 in) | |

KX9970R / KX9970FR

| Function | | KX9970R | KX9970FR | |
|---------------------|-------------------------|---|--|-------------------|
| Connectors | USB Virtual Media | | 2 x USB Type A Female (White) | |
| | Console Ports | Keyboard | 1 x USB Type A Female (White) | |
| | | Video | 1 x DisplayPort Female (Black) | |
| | | Mouse | 1 x USB Type A Female (White) | |
| | | Speaker | 1 x Mini Stereo Jack Female (Green) | |
| | | Mic. | 1 x Mini Stereo Jack Female (Pink) | |
| | RS-232 | | 1 x DB-9 Male (Black) | |
| | Power | | 2 x DC Jack (Black) | |
| LAN | | 1 x RJ-45 (Black) 2 x SFP+ Slot | 2 x SFP+ Slot | |
| Switches | Function | | 1 x Slide Switch (Black) (Extension, RS-232 Config) | |
| | OSD | | 1 x Pushbutton | |
| | Port (Up) | | 1 x Pushbutton | |
| | Port (Down) | | 1 x Pushbutton | |
| | Reset | | 1 x Semi-recessed Pushbutton | |
| LEDs | LAN (1000 / 10000 Mbps) | | 1 x (1000: Orange / 10000: Green) | |
| | Power | | 1 x Green | |
| | Local | | 1 x Green | |
| | Remote | | 1 x Green | |
| Emulation | Keyboard / Mouse | | USB | |
| Power Consumption | | DC12V;20.48W;137 BTU | DC12V;17.71W;124 BTU | |
| Video Resolution | | Up to 5120 x 2880 @ 30 Hz, 5120 x 1440 @ 60 Hz, 4096 x 2160 @ 60 Hz (4:4:4), 2560 x 1440 @ 144 Hz, 1920 x 1080 @ 240 Hz | | |
| Environment | Operating Temp. | | 0 – 50 °C | |
| | Storage Temp. | | -20 – 60 °C | |
| | Humidity | | 0–95% RH, Non-condensing | |
| Physical Properties | Housing | | Metal | |
| | Weight | | 1.38 kg (3.04 lb) | 1.39 kg (3.04 lb) |
| | Dimensions (L x W x H) | | 22.60 x 22.40 x 5.30 cm (8.90 x 8.82 x 2.09 in) | |

Optional Rack Mount

Optional rack mount kits are available as shown in the following table:

| Mount Type | Model |
|-----------------------|---------|
| Dual Rack Mount Kit | 2X-021G |
| Single Rack Mount Kit | 2X-031G |

Dual Rack Mount

The 2X-021G Dual Rack Mount Kit installs two KX9970 / KX9970F units side by side in 1U of server rack space.

Transmitter Dual Rack Mount

1. Remove four screws from the units and then use the same screws to secure the units together with the link bracket provided with the kit.

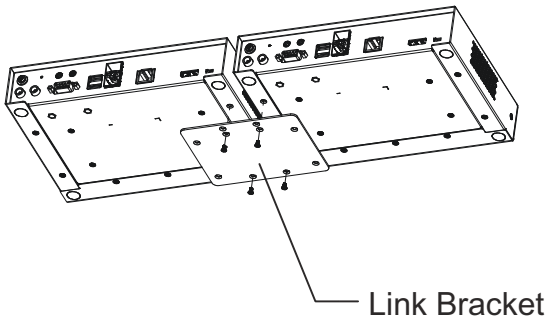

2. Remove the bottom and side screws from each unit.

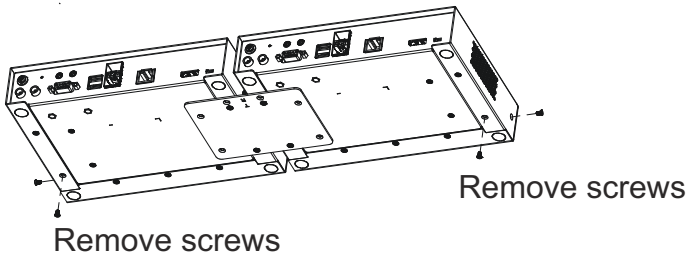

3. Use the screws in step 2 to install the left and right mounting brackets.

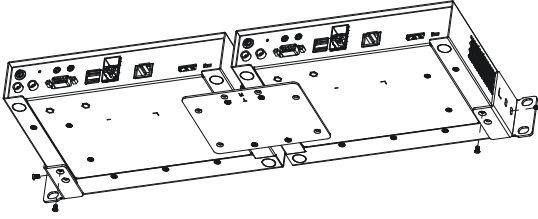

4. Screw the mounting brackets onto the rack.

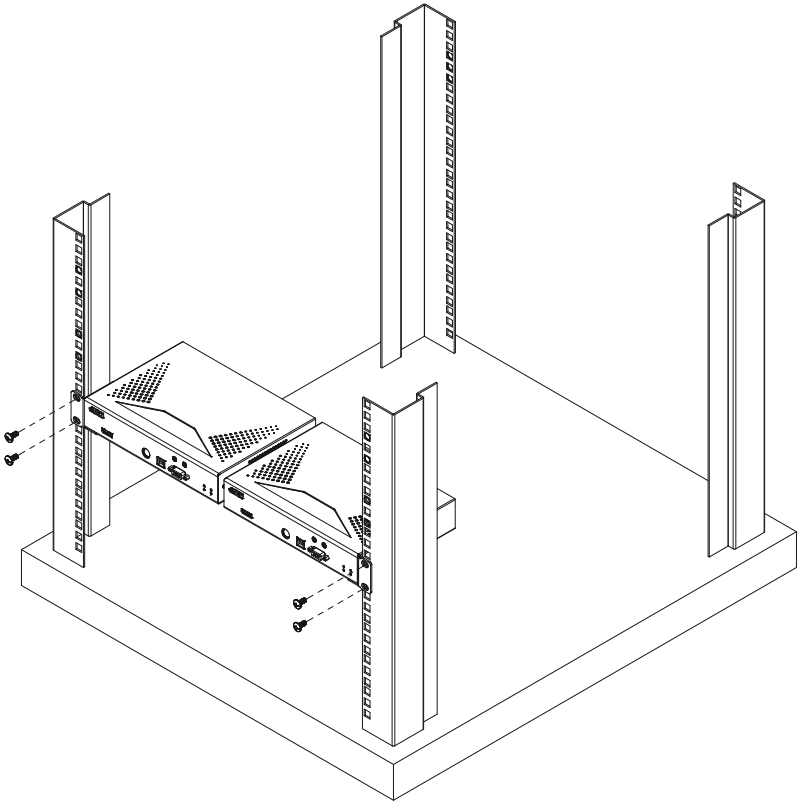

Receiver Dual Rack Mount

1. Remove the eight screws and plastic guards from the receiver units.

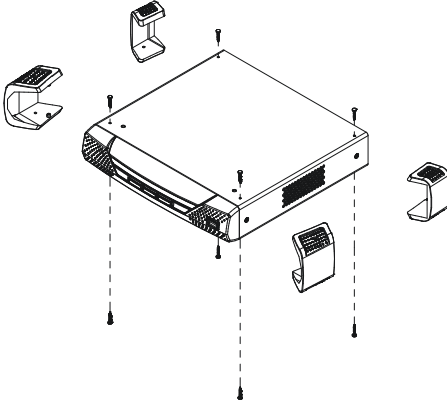

2. Remove four screws from the units and then use the same screws to secure the units together with the link bracket provided with the kit.

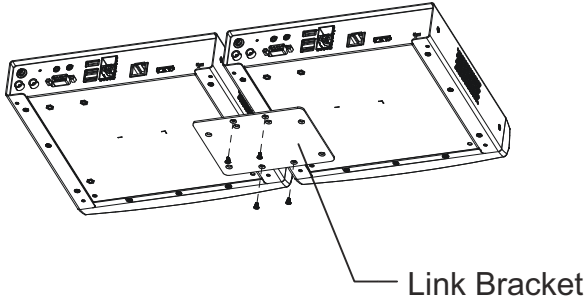

3. Remove the bottom and side screws from each unit.

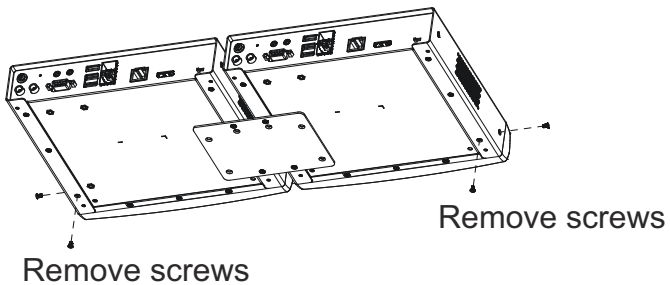

4. Use the screws in step 3 to install the left and right mounting brackets.

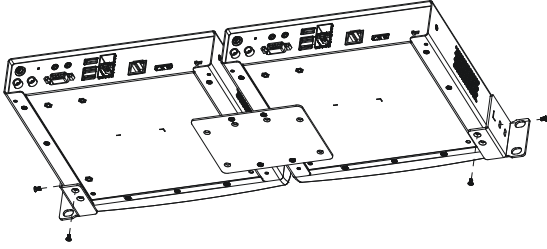

5. Screw the mounting brackets onto the rack.

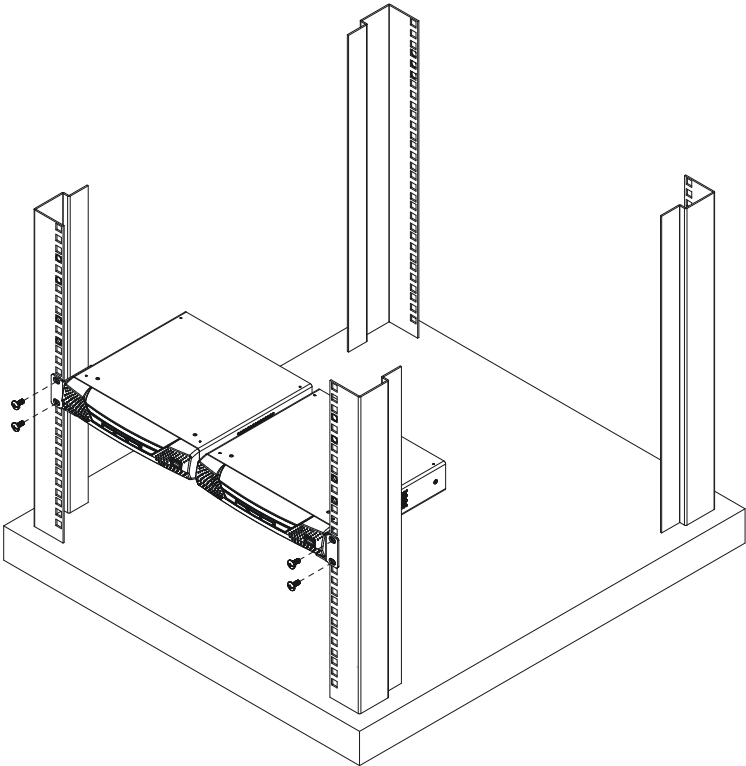

Single Rack Mount

The 2X-031G Single Rack Mount kit installs one KX Series receiver unit within a 1U rack space.

1. Remove the eight screws and plastic guards from the unit (receiver units only).

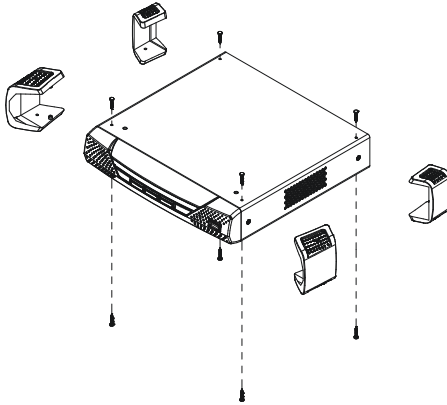

2. Remove the bottom and side screws from the unit.

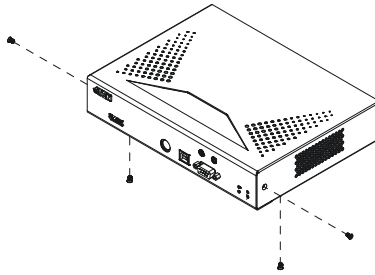

3. Use the screws in step 2 to install the right and left mounting brackets.

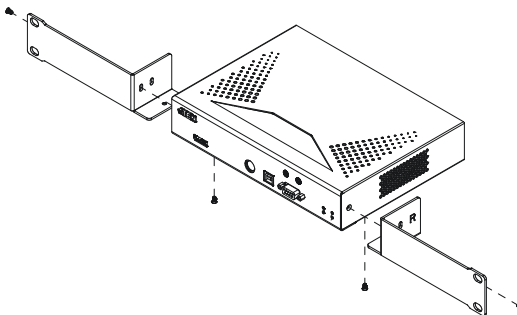

4. Screw the mounting brackets onto the rack.

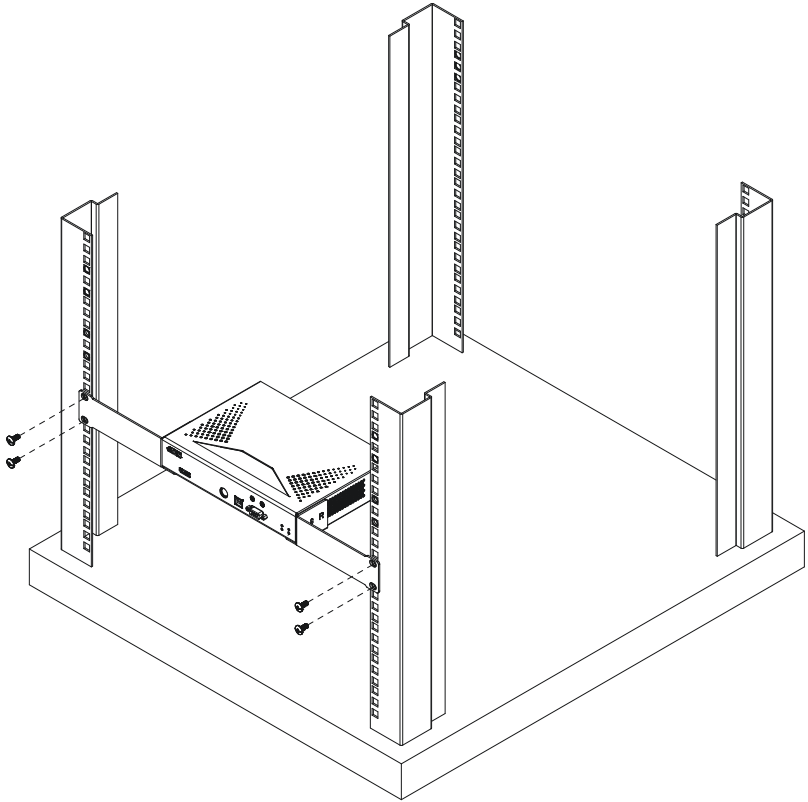

IP Installer

From a client computer running Windows, an IP address for a transmitter or receiver can be assigned with the IP Installer utility. The utility can be obtained from the Download area of our website or from the product page on the *Software & Driver* tab. After downloading the utility to your client computer, do the following:

1. Unzip the contents of IPInstaller.zip to a directory on your hard drive.
2. Go to the directory that you unzipped the IPInstaller program to and run IPInstaller.exe. A dialog box similar to the one below appears:

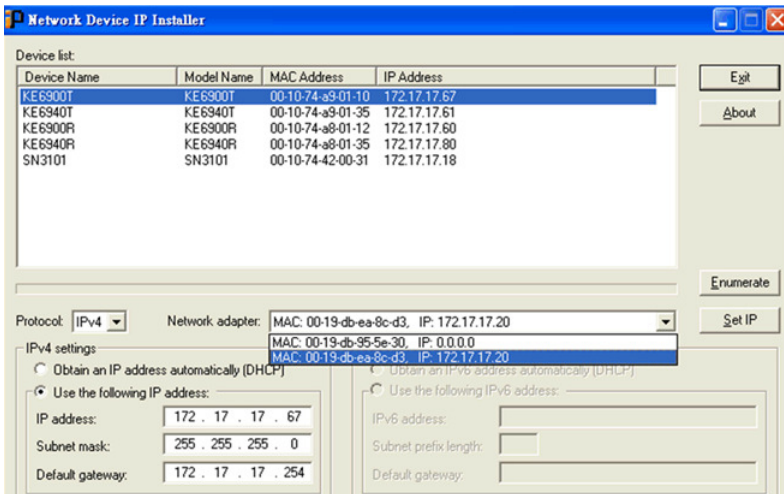

3. Select the Transmitter or Receiver in the Device List.

Note: 1. If the list is empty, or your device doesn't appear, click **Enumerate** to refresh the Device List.

2. If there is more than one device in the list, use the MAC address to pick the one you want. The MAC address is located on the devices bottom panel.

4. Select either *Obtain an IP address automatically (DHCP)*, or *Specify an IP address*. If you chose the latter, fill the IP Address, Subnet Mask, and Gateway fields with the information appropriate to your network.
5. Click **Set IP**.
6. After the IP address shows up in the Device List, click **Exit**.

Trusted Certificates

Overview

When you try to log in to the device from your browser, a Security Alert message appears to inform you that the device's certificate is not trusted, and asks if you want to proceed.

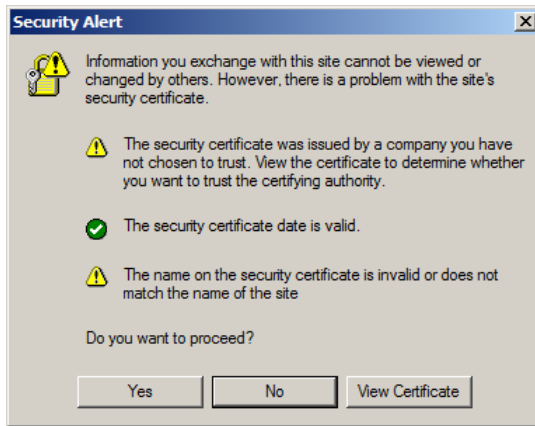

The certificate can be trusted, but the alert is triggered because the certificate's name is not found on the Microsoft list of Trusted Authorities. You can ignore the warning and click **Yes** to go on.

Self-Signed Private Certificates

If you wish to create your own self-signed encryption key and certificate, a free utility – `openssl.exe` – is available for download over the web at www.openssl.org. To create your private key and certificate do the following:

1. Go to the directory where you downloaded and extracted *openssl.exe* to.
2. Run `openssl.exe` with the following parameters:

```
openssl req -new -newkey rsa:1024 -days 3653 -nodes -x509  
-keyout CA.key -out CA.cer -config openssl.cnf
```

-
- Note:**
1. The command should be entered all on one line (i.e., do not press [Enter] until all the parameters have been keyed in).
 2. If there are spaces in the input, surround the entry in quotes (e.g., “ATEN International”).
-

To avoid having to input information during key generation the following additional parameters can be used:

```
/C /ST /L /O /OU /CN /emailAddress .
```

Examples

```
openssl req -new -newkey rsa:1024 -days 3653 -nodes -x509  
-keyout CA.key -out CA.cer -config openssl.cnf -subj  
"/C=yourcountry/ST=yourstateorprovince/L=yourlocationor  
city/O=yourorganization/OU=yourorganizationalunit/  
CN=yourcommonname/emailAddress=name@yourcompany.com
```

```
openssl req -new -newkey rsa:1024 -days 3653 -nodes -x509  
-keyout CA.key -out CA.cer -config openssl.cnf -subj  
"/C=CA/ST=BC/L=Richmond/O=ATEN International/OU=ATEN  
/CN=ATEN/emailAddress=eservice@aten.com.tw
```

Importing the Files

After the `openssl.exe` program completes, two files – `CA.key` (the private key) and `CA.cer` (the self-signed SSL certificate) – are created in the directory that you ran the program from.

Reset All Information

To reset all information (including passwords) to their default settings, follow the steps below:

1. Power off the unit and remove its housing.
2. Use a jumper cap to short the mainboard pins labeled **DEFAULT PASSWORD**. An example is shown:

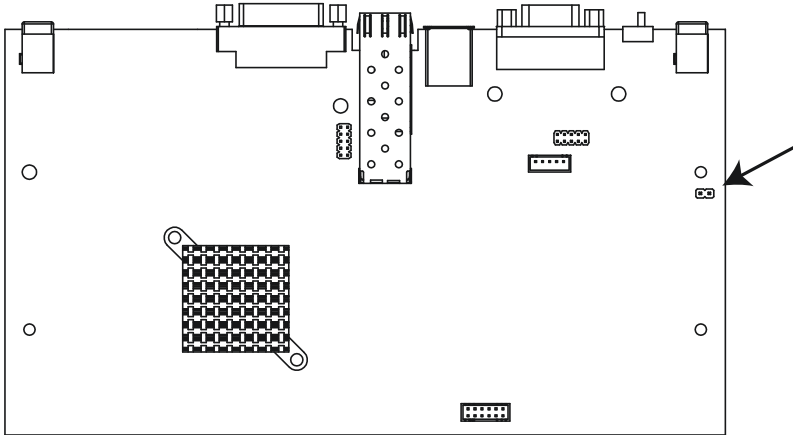

3. Power on the unit.
4. After the unit is turned on, power off the unit.
5. Remove the jumper cap from the **Reset** pins and close the housing.
6. Power on the unit again.

After powering on the unit, you can use the default administrator Username and Password (see *Logging In*, page 75) to log in.

Default Password Pins

The **Default Password** pins for different models are shown below.

■ **KX9970T / KX9970FT**

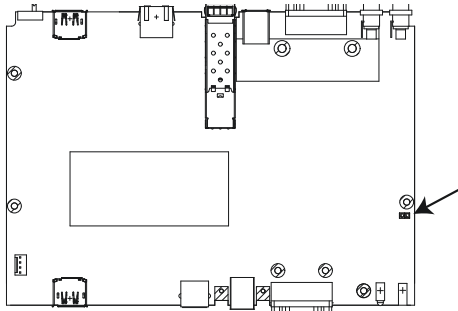

■ **KX9970R / KX9970FR**

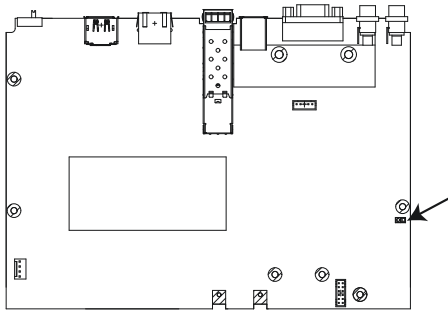

RS-232 Pin Assignments

Pin assignments for the Transmitter and Receiver's rear RS-232 port that is used for connecting to a serial terminal are given in the table, below:

| Pin | Assignment | |
|-----|------------|---------------------|
| 1 | N/A | None |
| 2 | RXD | Receive Data |
| 3 | TXD | Transmit Data |
| 4 | DTR | Data Terminal Ready |
| 5 | GND | Signal Ground |
| 6 | DSR | Data Set Ready |
| 7 | RTS | Request to Sent |
| 8 | CTS | Clear to Sent |
| 9 | N/A | None |

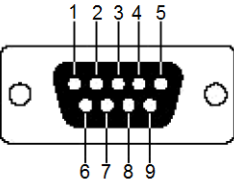

DB9 Male

Transmitter Front RS-232 Port

Pin assignments for the Transmitter's front RS-232 port that is used for connecting to a computer for serial control are given in the table, below:

| Pin | Assignment | |
|-----|------------|---------------------|
| 1 | N/A | None |
| 2 | TXD | Transmit Data |
| 3 | RXD | Receive Data |
| 4 | DSR | Data Set Ready |
| 5 | GND | Signal Ground |
| 6 | DTR | Data Terminal Ready |
| 7 | CTS | Clear to Sent |
| 8 | RTS | Request to Sent |
| 9 | N/A | None |

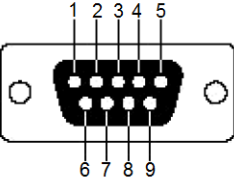

DB9 Female

Multicast IP Address

Multicasting helps to broadcast audio and video data from a transmitter to multiple Receivers over a network. To setup up Multicasting on a network switch you must know the Audio and Video Multicast IP address which can be found on the KX Transmitter. To determinate the default Multicast IP address set by the KX device use the instructions below. The Multicast IP addresses can be set manually using Telnet.

KX Multicast Rule

All Audio and Video Multicast IP addresses use the format: 230.X.Y.Z.

X.Y.Z relates to the Transmitter's IP address and **230** is always the first octet of a Multicast IP address. You use the Transmitter's IP address to find **X** and then use it to calculate the Audio and Video Multicast IP address.

Multicast IP Formula

To calculate the Audio and Video Multicast IP address, use the Transmitter's IP address to determine **X** and then use the appropriate table below to calculate the Multicast IP address for each data stream (audio/video).

Example:

Transmitter IP Address: 172.**16**.27.146; (172.**X**.Y.Z)

X =16

If X is between 0 ~ 127

| Transmitter IP | X | Video X + 128 | Audio X + 192 | Multicast Video IP Address | Multicast Audio IP Address |
|-------------------------------------|----|---------------------------------|---------------------------------|---|---|
| 172. 16 .27.146 (example) | 16 | <u>16</u> + 128 = 144 | <u>16</u> + 192 = 208 | 230. 144 .27.146 | 230. 208 .27.146 |
| | | <u> </u> + 128 = | <u> </u> + 192 = | 230. <u> </u> . <u> </u> . <u> </u> | 230. <u> </u> . <u> </u> . <u> </u> |
| | | <u> </u> + 128 = | <u> </u> + 192 = | 230. <u> </u> . <u> </u> . <u> </u> | 230. <u> </u> . <u> </u> . <u> </u> |
| | | <u> </u> + 128 = | <u> </u> + 192 = | 230. <u> </u> . <u> </u> . <u> </u> | 230. <u> </u> . <u> </u> . <u> </u> |

If X is between 128 ~ 192

| Transmitter IP | X - 128 = A | Video A + 128 | Audio A + 192 | Multicast Video IP Address | Multicast Audio IP Address |
|----------------------------|-------------------|-------------------|-------------------|----------------------------------|----------------------------------|
| 172.168.27.14 (example) | 168 - 128 = 40 | 40 + 128 = 168 | 40 + 192 = 232 | 230.168.27.14 | 230.232.27.14 |
| | ___ - 128 = | ___ + 128 = | ___ + 192 = | 230.____.____.____ | 230.____.____.____ |
| | ___ - 128 = | ___ + 128 = | ___ + 192 = | 230.____.____.____ | 230.____.____.____ |
| | ___ - 128 = | ___ + 128 = | ___ + 192 = | 230.____.____.____ | 230.____.____.____ |

If X is 192 or higher

| Transmitter IP | X - 192 = A | Video A + 128 | Audio A + 192 | Multicast Video IP Address | Multicast Audio IP Address |
|----------------------------|------------------|------------------|------------------|----------------------------------|----------------------------------|
| 172.200.27.14 (example) | 200 - 192 = 8 | 8 + 128 = 136 | 8 + 192 = 200 | 230.136.27.14 | 230.200.27.14 |
| | ___ - 192 = | ___ + 128 = | ___ + 192 = | 230.____.____.____ | 230.____.____.____ |
| | ___ - 192 = | ___ + 128 = | ___ + 192 = | 230.____.____.____ | 230.____.____.____ |
| | ___ - 192 = | ___ + 128 = | ___ + 192 = | 230.____.____.____ | 230.____.____.____ |

Keys to Network Performance

For optimum performance, KX Series devices requires high amounts of data to be transferred across a network; therefore we recommend the following strategies to setup KX Series devices. Using our suggestions will provide better performance and the highest video resolutions possible. Use each of the keys to ensure the best transmission of data and the highest throughput possible.

Build a Network Diagram

To build an effective KX installation, start by mapping out the layout. Create a diagram with the KX devices, computers and routers along with how they will be connected across the network. It also helps to write out how the devices will interact. Use this diagram as the frame work as you decide what devices to purchase and how to build the network effectively for the best data throughput.

Considerations:

- ◆ If possible, create a private network for the KX devices
- ◆ Use the same switch model throughout
- ◆ Use a flat cascaded layout
- ◆ Avoid a tree or pyramid structure
- ◆ Limit cascades to two levels
- ◆ Install network switches near each other
- ◆ Minimize the distance of connections
- ◆ Install KVM over IP Matrix Manager (CCKM) computer and KX devices on the same subnet
- ◆ Check the 3 Other Factors before installation

Other Factors

■ Choose the Right Cable

Always use Cat 5/6e Ethernet cable or higher installed by a professional between any two devices you are installing. We recommend using ATEN Brand Ethernet cable to ensure the quality. It's best when installing KX devices to use brand new Ethernet cabling for each part of the installation to ensure the reliability of the data being transmitted. This is a key to getting the best uninterrupted video resolution across the network.

■ Determine the Distance

Distance is an important factor when setting up networks, with a shorter distance and fewer hops through routers, data can be transmitted more efficiently. So whenever possible decrease the distance and direct network traffic effectively between subnets that communicate with each other to increase the data throughput.

■ Ensure the Bandwidth

Ensuring the bandwidth ahead of time will guarantee performance before installing KX devices on a network. This will eliminate the primary cause of problems related to video quality and transmission of data. If the speed is right at all ends of your network, then the only other causes are derived from device failure or limits caused by a router, switch or device setting.

Sample Network Diagram

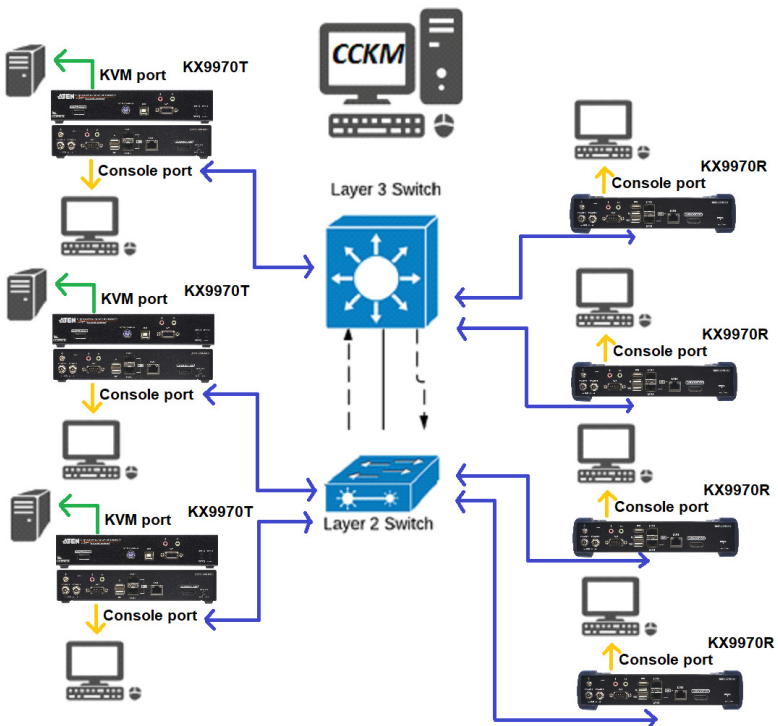

Choose a High Performance Switch

A high performance network switch is the means of a successful KX setup. When choosing a network switch, first select the type:

Layer 2 or Layer 3 Switches

You'll need to determine whether you need a layer 2 or a layer 3 switch for your KX network. Layer 3 switches cost more than layer 2 switches because they are more complex and handle more network traffic. The best way to calculate which type of switch you need is to first determine if you will have a dedicated network for the KX devices or if the KX devices will be on a network that shares throughput with other network equipment such as computers, servers and printers. If they share the network with other devices its best to consider a layer 3 switch and use layer 2 switches exclusively for the KX device connections. For larger installations we recommend using Layer 3 switches. The major differences are:

Layer 3 Switch: IP addresses in packets are examined and intelligent forwarding decisions are made. On a larger network broken into subnets across long distances, a layer 3 switch becomes the best choice as they can improve network efficiency and provide better traffic flow. They are better at directing more traffic to different locations on a larger more complex network, and with layer two switches working below them.

Layer 2 Switch: Packets are examined and forwarded using only the MAC address. If you have a small central network, a layer 2 switch should do the job. If the network is exclusive and will only transmit the bandwidth of KX devices, layer 2 switches with the correct settings can get the job done effectively.

Considerations

Number of ports

Choose a switch that has enough ports to match the number of KX devices you will be installing. Switches typically come in 5, 8, 10, 16, 24, 28, 48, and 52-port configurations. If you are installing 13 KX transmitters and 13 KX receivers, you will need to purchase a switch with at least 28 ports.

Stackable verse Standalone

Stackable switches allow you to easily manage and configure ports spanning across multiple switches that the KX devices are connected through. This provides a centralized method to configure and troubleshoot the initial setup of

KX devices on a network which makes fine tuning the bandwidth, data throughput and video quality easier. Stackable switches can be configured to direct the KX transmissions between many units more specifically and effectively. Standalone switches provide the same configuration features as Stackable switches but they must be set individually.

Stackable switches provide an easy way to manage multiple switches, as one unit. For example, instead of configuring, managing, and troubleshooting 6 28-port switches individually, you can manage the six as if they are a single unit using Stackable Switches. The six switches (168 ports) function as a single switch and are managed from one web or GUI interface.

What Stackable Switches Can do:

1. Create a link aggregation group with one port in one unit of the stack and another port of that group in another switch in the stack.
2. Select a port on one switch in the stack and mirror the traffic to a switch port on another unit of the stack; thus copy the configuration to direct traffic more effectively between KX devices.
3. Apply custom ACL security settings to any port on any switch in the stack.
4. Stackable switches can be setup in a ring configuration, so that if a port or cable fails, the stack automatically routes around the failure, at microsecond speeds. Stackable Switches also allow you to add and remove stack “members” which are automatically updated and recognized as such.

Switch Specifications

The following specifications are recommended when choosing a layer 2 or layer 3 switch:

- ◆ 10G Gigabit Ethernet switches (10G or faster Ethernet ports)
- ◆ High bandwidth between switches, if possible using Fibre Channel
- ◆ Layer 3 switches that efficiently processes IGMP queries
- ◆ IGMP Snooping v2 or v3
- ◆ Flow Control Functions
- ◆ Throughput of: Full Duplex, 10G up- and down- stream speeds per port
- ◆ Performance of their most onerous tasks (e.g. IGMP snooping) with multiple dedicated processors (ASICs)
- ◆ Use the same switch make and model throughout each subnet

- ◆ The maximum number of simultaneous ‘snooperable groups’ the switch can handle meets or exceeds the number of KX transmitters that will be used to create Channel groups

Configuring Switches and KX Devices

Configuring the switch correctly will pass data more efficiently, allowing a better stream across the network to each KX device. The following settings will help optimize your network traffic through a switch:

- ◆ Enable IGMP Snooping on L2 switches
- ◆ Enable IGMP Querier on the L3 switch
- ◆ Enable IGMP Fast-Leave on all switches where KX units are directly connected
- ◆ Enable Spanning Tree Protocol (STP) on all switches and enable Portfast exclusively on switch ports that have KX units connected
- ◆ Pick an appropriate forwarding mode on all switches. Use Cut-through if available, or Store and Forward (see *Recommended Network Switches* below)

KX transmitter Settings:

- ◆ Adjust the KX transmitter settings one at a time, in small intervals, and view the images as you do, so that you can adjust to the positive or negative results and achieve the best quality and bandwidth possible
- ◆ If the quality of color is important, set the Color Depth to 24 bits and manually adjust other settings until you are satisfied with the visual appearance
- ◆ If moving video images are shown frequently, increase the Video Quality setting to the highest level and reduce the Bandwidth Limit and Color Depth setting.
- ◆ When images on the screen are more often static, increase the Background Refresh and/or the Video Quality settings
- ◆ Check that all KX units have been updated with the latest firmware version

Recommended Network Switches

Please refer to the FAQ link below on how to select network switches and network switch information collected by ATEN Customer Service Division, where the collected information includes customer's feedback from their actual experience in using and installing the product(s).

<https://eservice.aten.com/eServiceCx/Common/FAQ/view.do?id=6276>

Additional Mouse Synchronization Procedures

If the mouse synchronization procedures mentioned in the manual fail to resolve mouse pointer problems for particular computers, try the following:

Windows:

Note: In order for the local and remote mice to synchronize, you must use the generic mouse driver supplied with the MS operating system. If you have a third party driver installed - such as one supplied by the mouse manufacturer - you must remove it.

1. Windows 2000:
 - a) Open the Mouse Properties dialog box (Control Panel → Mouse → Mouse Properties)
 - b) Click the *Motion* tab
 - c) Bring the mouse speed to the middle position (6 units in from the left)
 - d) Set the mouse acceleration to *None*

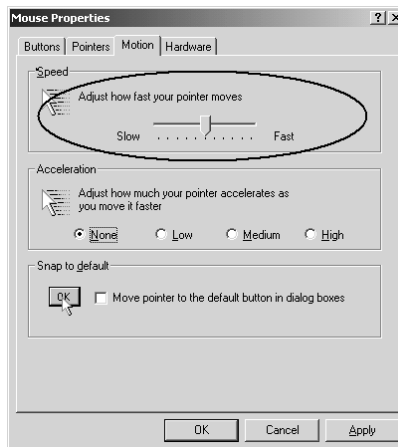

2. Windows XP / Windows Server 2003 / Windows 7 / Windows 8 / Windows 10:
 - a) Open the Mouse Properties dialog box (Control Panel → Mouse)
(For Windows 10, click Start → Devices → Mouse → Additional mouse options)

- b) Click the *Pointer Options* tab
- c) Bring the mouse speed to the middle position (6 units in from the left)
- d) Disable *Enhance Pointer Precision*

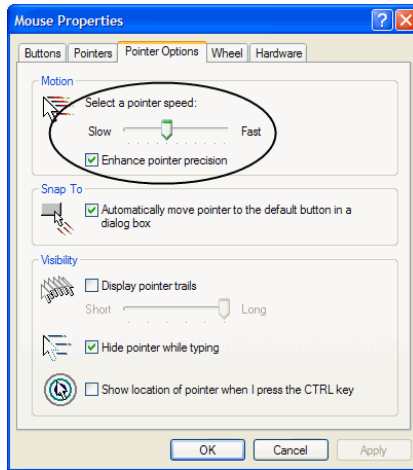

3. Windows ME:
Set the mouse speed to the middle position; disable mouse acceleration (click **Advanced** to get the dialog box for this).
4. Windows NT / Windows 98 / Windows 95:
Set the mouse speed to the slowest position.

Sun / Linux

Open a terminal session and issue the following command:

```
Sun: xset m 1
```

```
Linux: xset m 0
```

```
or
```

```
xset m 1
```

(If one does not help, try the other.)

Virtual Media Support

WinClient ActiveX Viewer / WinClient AP

- ◆ IDE CDROM/DVD-ROM Drives – Read Only
- ◆ IDE Hard Drives – Read Only
- ◆ USB CDROM/DVD-ROM Drives – Read Only
- ◆ USB Hard Drives – Read/Write*
- ◆ USB Flash Drives – Read/Write*
- ◆ USB Floppy Drives – Read/Write

* These drives can be mounted either as Drives or Removable Disks (see *Virtual Media*, page 301). Mounting them as removable disks allow booting the remote server if the disk contains a bootable OS. In addition, if the disk contains more than one partition, the remote server can access all the partitions.

- ◆ ISO Files – Read Only
- ◆ Folders – Read/Write
- ◆ Smart Card Readers

Java Applet Viewer / Java Client AP

- ◆ ISO Files – Read Only
- ◆ Folders – Read/Write

Note: 1. The Java Client supports Virtual Media in the same way as WinClient does – however, the account should have Administrator level privilege.

2. Folder mapping uses a FAT16 file system, so there is a 2G limitation. Virtual Media only supports ISO files less than 4G.
-

Setup CCKM Server IP address on Windows

1. Select **Network and Sharing Center** and click **Change adapter settings**.
2. Right-click **Local Area Connection** and select **Properties**.
3. In the Local Area Connection Properties window, highlight **Internet Protocol Version 4 (TCP/IPv4)** then click **Properties**.
4. Select **Use the following IP address** and enter in the IP for the CCKM server (e.g. any IP address not in use, and in between 192.168.0.2 and 192.168.0.253)*, Subnet Mask (e.g. 255.255.255.0), and Default Gateway that corresponds with your network setup.
5. Click **OK** to change the CCKM server's IP address.

Note: Make sure the CCKM server's IP address is not a duplicate to prevent IP address conflict.

To connect to the CCKM server via web browser, enter the CCKM IP address and port number (default: 8443). For example, if the CCKM IP address is 192.168.0.10, then enter [https://192.168.0.10: 8443](https://192.168.0.10:8443).

If you have a 2nd NIC, please follow the following steps.

6. Select **Network and Sharing Center** and click **Change adapter settings**.
7. Right-click **Local Area Connection** for the 2nd NIC and select **Properties**.
8. In the Local Area Connection Properties window, highlight **Internet Protocol Version 4 (TCP/IPv4)** then click **Properties**.
9. Select **Use the following IP address** and enter in the IP of the 2nd subnet for the CCKM server (e.g. any IP address not in use, and in between 192.168.1.2 and 192.168.1.253)*, Subnet Mask (e.g. 255.255.255.0), and Default Gateway that corresponds with your network setup.
10. Click **OK** to change the CCKM server's IP address of the 2nd subnet.

Limited Warranty

ATEN warrants its hardware in the country of purchase against flaws in materials and workmanship for a Warranty Period of two [2] years (warranty period may vary in certain regions/countries) commencing on the date of original purchase. This warranty period includes the [LCD panel of ATEN LCD KVM switches](#). Select products are warranted for an additional year (see [A+ Warranty](#) for further details). Cables and accessories are not covered by the Standard Warranty.

What is covered by the Limited Hardware Warranty

ATEN will provide a repair service, without charge, during the Warranty Period. If a product is defective, ATEN will, at its discretion, have the option to (1) repair said product with new or repaired components, or (2) replace the entire product with an identical product or with a similar product which fulfills the same function as the defective product. Replaced products assume the warranty of the original product for the remaining period or a period of 90 days, whichever is longer. When the products or components are replaced, the replacing articles shall become customer property and the replaced articles shall become the property of ATEN.

To learn more about our warranty policies, please visit our website:

<http://www.aten.com/global/en/legal/policies/warranty-policy/>

© Copyright 2023 ATEN® International Co., Ltd.
Released: 2023-02-13

ATEN and the ATEN logo are registered trademarks of ATEN International Co., Ltd. All rights reserved. All other brand names and trademarks are the registered property of their respective owners.