



Simply Better Connections

AS104 / AS106 / AS108

4" (AS104) / 6.5" (AS106) / 8" (AS108)

Coaxial Ceiling Loudspeakers

User Manual

Compliance Statements



RoHS

This product is RoHS compliant.

User Information

Online Registration

Be sure to register your product at our online support center:

International	http://eservice.aten.com
---------------	---

Telephone Support

For telephone support, call this number:

International	886-2-8692-6959
China	86-400-810-0-810
Japan	81-3-5615-5811
Korea	82-2-467-6789
North America	1-888-999-ATEN ext 4988 1-949-428-1111

User Notice

All information, documentation, and specifications contained in this manual are subject to change without prior notification by the manufacturer. The manufacturer makes no representations or warranties, either expressed or implied, with respect to the contents hereof and specifically disclaims any warranties as to merchantability or fitness for any particular purpose. Any of the manufacturer's software described in this manual is sold or licensed *as is*. Should the programs prove defective following their purchase, the buyer (and not the manufacturer, its distributor, or its dealer), assumes the entire cost of all necessary servicing, repair and any incidental or consequential damages resulting from any defect in the software.

The manufacturer of this system is not responsible for any radio and/or TV interference caused by unauthorized modifications to this device. It is the responsibility of the user to correct such interference.

The manufacturer is not responsible for any damage incurred in the operation of this system if the correct operational voltage setting was not selected prior to operation. PLEASE VERIFY THAT THE VOLTAGE SETTING IS CORRECT BEFORE USE.

Product Information

For information about all ATEN products and how they can help you connect without limits, visit ATEN on the Web or contact an ATEN Authorized Reseller. Visit ATEN on the Web for a list of locations and telephone numbers:

International	http://www.aten.com
North America	http://www.aten-usa.com

Package Contents

Check to make sure that all the components are in working order. If you encounter any problem, please contact your dealer.

- ◆ 2 AS104 (4") / AS106 (6.5") / AS108 (8") Coaxial Ceiling Loudspeakers
- ◆ 2 Euroblock connectors
- ◆ 2 ceiling reinforcement kits
- ◆ 2 cutout templates
- ◆ 2 speaker grilles
- ◆ 1 user instructions

Contents

Compliance Statements	ii
User Information	iii
Online Registration	iii
Telephone Support	iii
User Notice	iii
Product Information	iv
Package Contents	v
Contents	vi
About this Manual	viii
Conventions	ix
1. Introduction	
Overview	1
Features	2
Planning the Installation	3
Requirements	3
Components	4
Hardware Overview	4
2. Hardware Setup	
Connecting the AS104 / AS106 Unit	7
3. Operation	
Frequency Response Chart	13
Polarity	14
Safety Cable Anchor	16
Adjusting the Tap Selector	17
Appendix	
Safety Instructions	19
General	19
Technical Support	21
International	21

North America	21
Specifications	22
AS104	22
AS106.....	23
AS108	24
ATEN Standard Warranty Policy	25
Limited Warranty	25

About this Manual

This user manual is provided to help you get the most from the AS104 / AS106 / AS108 unit. It covers all aspects of installation, configuration, and operation. An overview of the information found in the manual is provided below.

Chapter 1, *Introduction* introduces you to the Coaxial Ceiling Loudspeakers. Its purpose, features, installation considerations, and panel components are presented and described.

Chapter 2, *Hardware Setup* describes the steps that are necessary to quickly and safely set up your installation.

Chapter 3, *Operation* explains the audio source input operation using the Coaxial Ceiling Loudspeakers and its limitations.

Appendix, provides a list of safety instructions and precautions, contact information for ATEN technical support, product specifications, and other technical information.

Note:

- ◆ Read this manual thoroughly and follow the installation and operation procedures carefully to prevent any damage to the unit or any connected devices.
 - ◆ This product may be updated, with features and functions added, improved or removed since the release of this manual. For an up-to-date user manual, visit <http://www.aten.com/global/en/>
-

Conventions

This manual uses the following conventions:

- Monospaced Indicates text that you should key in.
- [] Indicates keys you should press. For example, [Enter] means to press the **Enter** key. If keys need to be chorded, they appear together in the same bracket with a plus sign between them: [Ctrl+Alt].
1. Numbered lists represent procedures with sequential steps.
- ◆ Bullet lists provide information, but do not involve sequential steps.
- > Indicates selecting the option (on a menu or dialog box, for example), that comes next. For example, Start > Run means to open the *Start* menu, and then select *Run*.
-  Indicates critical information.

This Page Intentionally Left Blank

Chapter 1

Introduction

Overview

The AS104 / AS106 / AS108 comes in a pair of 4" / 6.5" / 8" coaxial 2-way ceiling loudspeakers that deliver decent sonic performance. Each speaker ships with a 4" / 6.5" / 8" woofer, 20 mm dome tweeter, and 30 W RMS, 60 W peak (8 Ω) / 60 W RMS, 120 W peak (8 Ω) / 80W RMS, 160W peak (8 Ω) power handling capability. Excellent and consistent sound quality is ensured by taking advantages of its 100 - 20 kHz / 80 - 20 kHz / 65 - 20 kHz bandwidth and wide coverage, allowing less speakers used to cover the listening area to lower the cost of the system installed.

The loudspeaker contains a matching transformer, running comfortably on 70 / 100 V lines or at 8 Ω to suit various application demands. Phase issues are minimized as a result of the adoption of the coaxial neodymium magnetic driver, making sound waves with various frequency bands easier to be added together instead of canceling each other out. Made of UL94-V0-compliant flame retardant materials, the housing, together with the Zinc-coated steel backcan, improve safety for applications where flame and fire protection is of the highest importance. When it comes to installation, each speaker features a cutout template for quick and easy post construction installation and can be secured with its dog-leg mounting system. The paintable magnetic grille assures effortless installation and cleaning while giving unobtrusive appearance in any room design.

AS104 / AS106 / AS108 is ideal for residence and enterprise-grade audio applications, such as auditoriums, houses of worship, sports venues, and any small or mid-sized commercial spaces that require a clear and intelligible sound solution without compromise on life safety.

Features

- ◆ Coaxial design with premium components:
 - ◆ 4" / 6.5" / 8" high output driver with rubber surround and heavy-duty voice coil
 - ◆ 20 mm dome tweeter
- ◆ 100 - 20 kHz (AS104) / 80 - 20 kHz (AS106) / 65 - 20 kHz (AS108) bandwidth with wide coverage for consistent, full-range coverage of the space while reducing the amount of the speakers needed
- ◆ Switchable for use as either an 8 Ω low-impedance speaker or as part of a 70V / 100V distributed loudspeaker system
- ◆ UL94-V0 compliance for life safety applications
- ◆ Paintable magnetic grille for blending into any room decor
- ◆ Ease of installation guaranteed with the magnetic grille, dog leg mounting system and cutout template

Planning the Installation

Requirements

Prepare the following before installing the AS104 / AS106 unit:

- ◆ 1 amplifier
- ◆ 1 or more audio source devices

Components

Hardware Overview

AS104

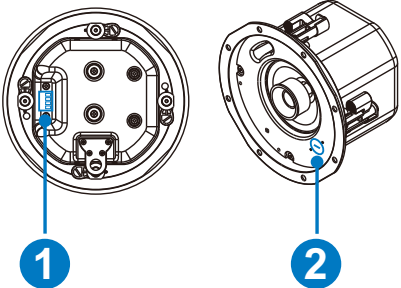

AS106 / AS108

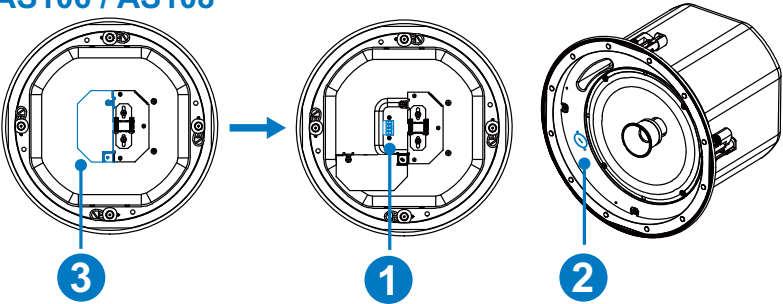

AS104

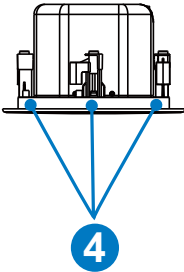

AS106 / AS108

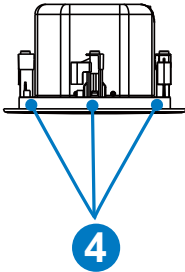

No.	Component	Description
1	terminal ports	Connects to an amplifier or other speaker via a 5.08 mm Euroblock connector.
2	tap selector	Adjusts the speaker impedance.
3	terminal cover (AS106 / AS108)	Secures the wirings pipe in place.
4	rotating mount tabs (dog-legs)	Mounts the speakers to the ceiling tiles.

This Page Intentionally Left Blank

Chapter 2

Hardware Setup



1. Please review the safety information regarding the placement of this device in *Safety Instructions*, page 19.
2. Do not power on the AS104 / AS106 / AS108 until all the necessary hardware is connected.

Connecting the AS104 / AS106 Unit

Follow the steps below to connect the AS104 / AS106 / AS108 to an amplifier.

1. Use the cutout template as a guide to cut a hole on your ceiling tile.

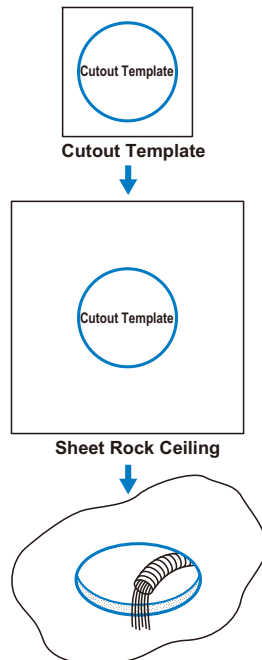

2. Do the following to enhance the stability of the AS104 / AS106 / AS108 speakers installed on the ceiling tile:

- a) Insert and screw the C-bracket on the V-rails.
- b) Insert both ends of the V-rails on to a suspended ceiling.

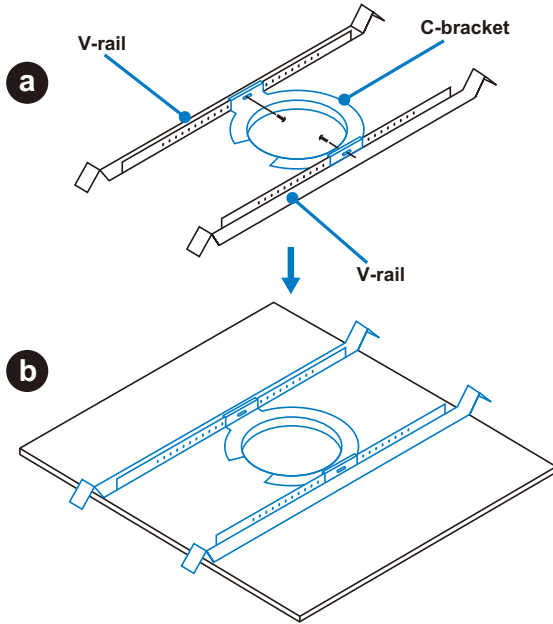

3. Strip insulation back about 5 mm on self-supplied speaker wires.

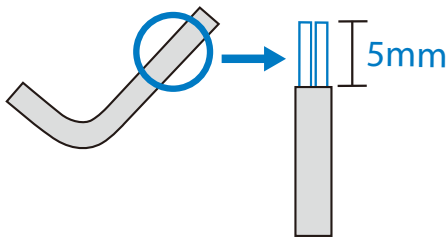

4. Insert the wire leads into the Euroblock connector and screw the hold-down screw until tight.

Note:

- ◆ Please do not tin the wire leads when connecting the Euroblock connector. Tinned wires may influence the sound quality and could be pulled out easily.
 - ◆ To avoid rattling from the vibration, tighten any unused hold-down screws.
-

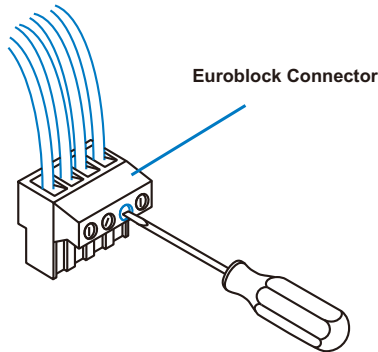

5. Based on your application type, refer to the corresponding diagram to connect the terminal ports on the AS104 / AS106 / AS108 to your output device.

Note:

- ◆ If you are connecting the terminal ports on the AS106 / AS108 , please slide the terminal cover open by loosening the screws.
 - ◆ Make sure the tap selector on the speakers is set to a proper position, please refer to your power amplifier settings before adjusting the tap selector.
 - ◆ For Low-Z output, make sure the tap selector on the speakers is set to 8R position.
-

AS104

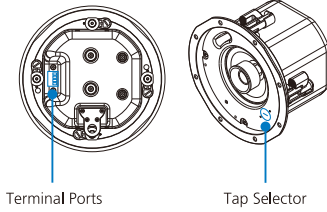

AS106 / AS108

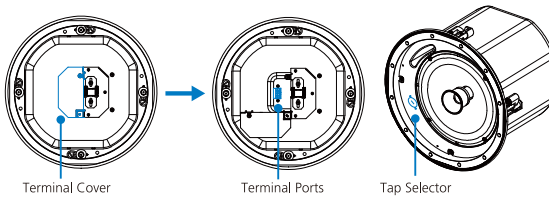

Mono Application Hi-Z Output

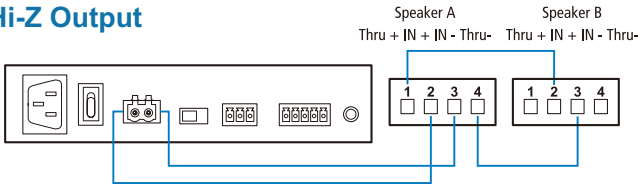

Stereo Application Low-Z Output

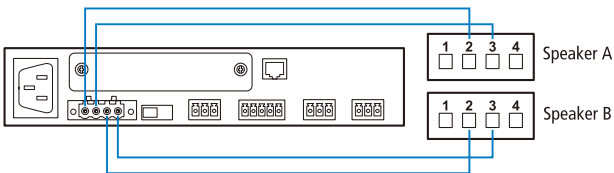

- Screw the four rotating mount tabs (dog-legs) tightly to the ceiling tile.

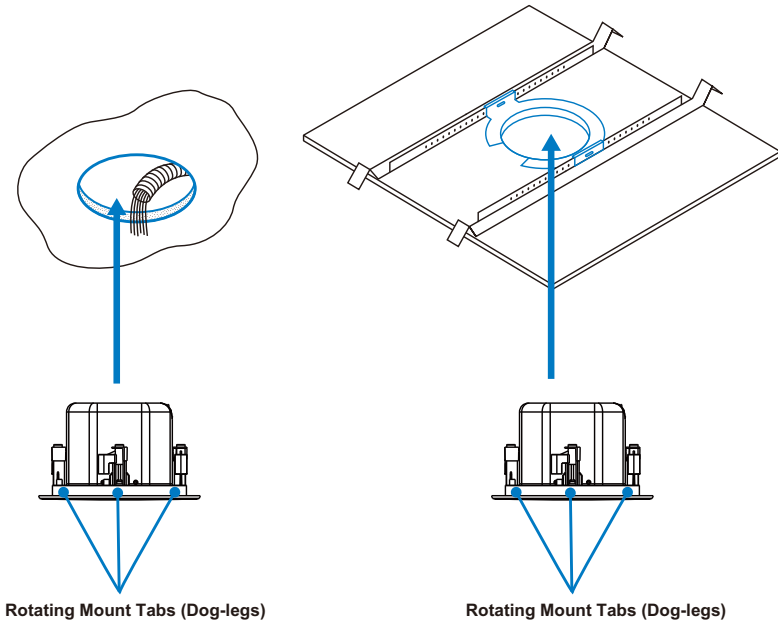

- Attach the speaker grilles onto the AS104 / AS106 / AS108 speakers.

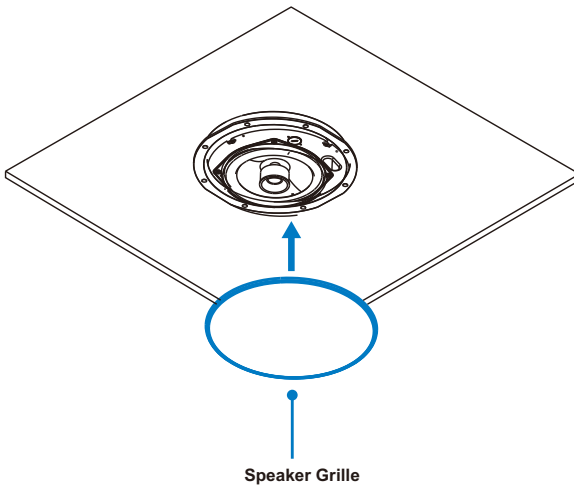

This Page Intentionally Left Blank

Chapter 3 Operation

Frequency Response Chart

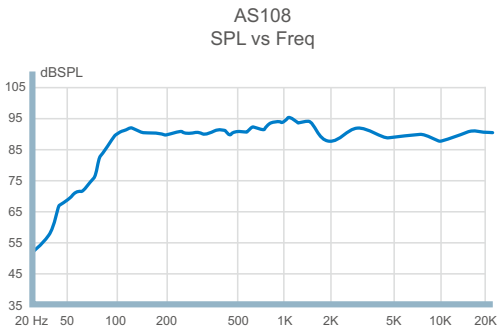
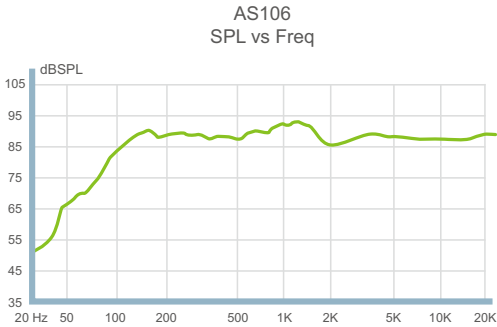
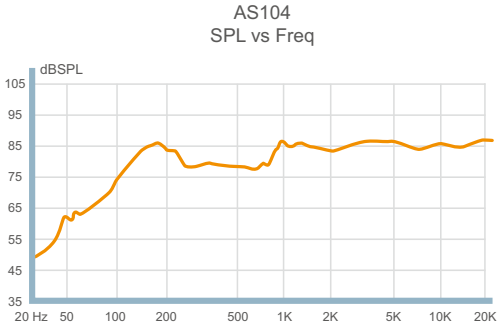

Polarity

AS104
SPL vs Angle (1KHz)

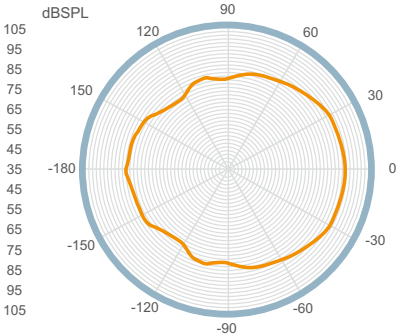

AS106
SPL vs Angle (1KHz)

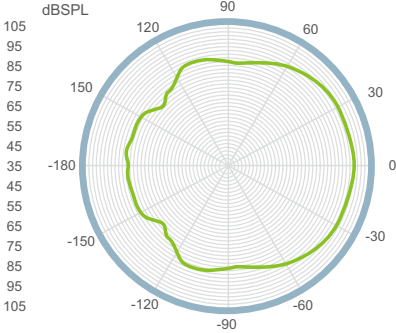

AS108
SPL vs Angle (1KHz)

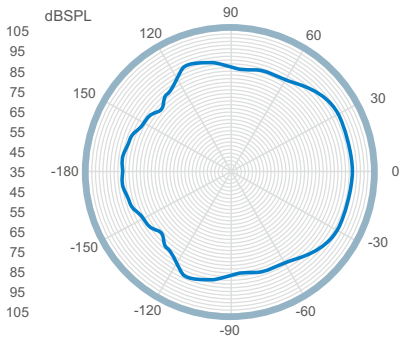

Safety Cable Anchor

A safety cable anchor is available on the back of each unit for securing the speakers in case the ceiling tile breaks. Please do not omit this step. ATEN strongly recommended to secure the speakers using its safety cable anchors to a separate secure point.

AS104

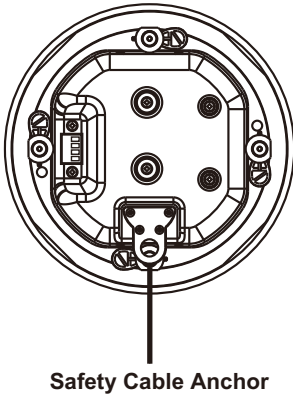

AS106 / AS108

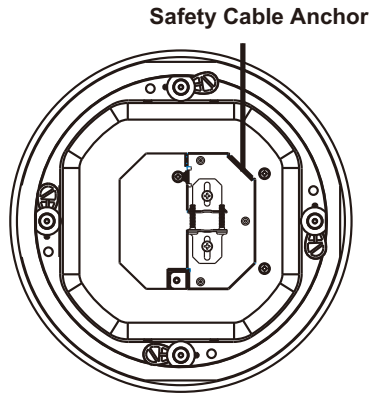

Adjusting the Tap Selector

A tap selector can be found on the front baffle of each unit. It is necessary to adjust to tap selector before powering on the speaker and attaching the speaker grille. Turn the selector clockwise to adjust the distributed system tap settings.

AS104

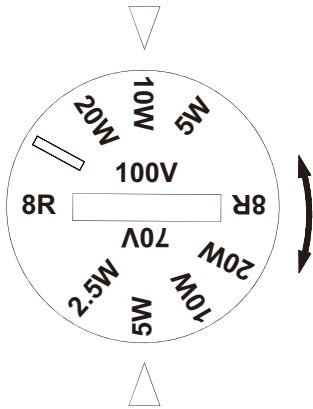

AS106

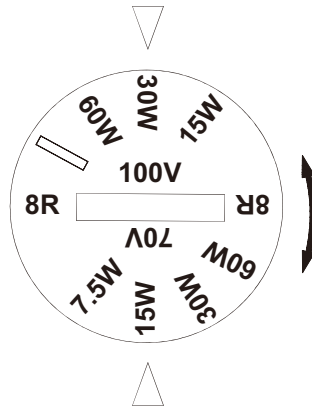

AS108

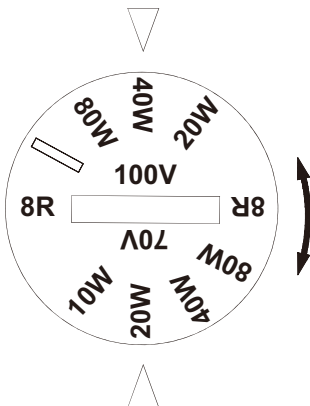

This Page Intentionally Left Blank

Safety Instructions

General

- ◆ This product is for indoor use only.
- ◆ Read all of these instructions. Save them for future reference.
- ◆ Follow all warnings and instructions marked on the device.
- ◆ Do not place the device on any unstable surface (cart, stand, table, etc.). If the device falls, serious damage will result.
- ◆ Do not use the device near water.
- ◆ Do not place the device near, or over, radiators or heat registers.
- ◆ The device cabinet is provided with slots and openings to allow for adequate ventilation. To ensure reliable operation, and to protect against overheating, these openings must never be blocked or covered.
- ◆ The device should never be placed on a soft surface (bed, sofa, rug, etc.) as this will block its ventilation openings. Likewise, the device should not be placed in a built in enclosure unless adequate ventilation has been provided.
- ◆ Never spill liquid of any kind on the device.
- ◆ Unplug the device from the wall outlet before cleaning. Do not use liquid or aerosol cleaners. Use a damp cloth for cleaning.
- ◆ The device should be operated from the type of power source indicated on the marking label. If you are not sure of the type of power available, consult your dealer or local power company.
- ◆ To prevent damage to your installation it is important that all devices are properly grounded.
- ◆ Do not allow anything to rest on the power cord or cables. Route the power cord and cables so that they cannot be stepped on or tripped over.
- ◆ Position system cables and power cables carefully; Be sure that nothing rests on any cables.
- ◆ Never push objects of any kind into or through cabinet slots. They may touch dangerous voltage points or short out parts resulting in a risk of fire or electrical shock.

- ◆ Do not attempt to service the device yourself. Refer all servicing to qualified service personnel.
- ◆ If the following conditions occur, unplug the device from the wall outlet and bring it to qualified service personnel for repair.
 - ◆ The power cord or plug has become damaged or frayed.
 - ◆ Liquid has been spilled into the device.
 - ◆ The device has been exposed to rain or water.
 - ◆ The device has been dropped, or the cabinet has been damaged.
 - ◆ The device exhibits a distinct change in performance, indicating a need for service.
 - ◆ The device does not operate normally when the operating instructions are followed.
- ◆ Only adjust those controls that are covered in the operating instructions. Improper adjustment of other controls may result in damage that will require extensive work by a qualified technician to repair.

Technical Support

International

- ◆ For online technical support – including troubleshooting, documentation, and software updates: <http://support.aten.com>
- ◆ For telephone support, see *Telephone Support*, page iii:

North America

Email Support		support@aten-usa.com
Online Technical Support	Troubleshooting Documentation Software Updates	http://www.aten-usa.com/support
Telephone Support		1-888-999-ATEN ext 4988

When you contact us, please have the following information ready beforehand:

- ◆ Product model number, serial number, and date of purchase
- ◆ Your computer configuration, including operating system, revision level, expansion cards, and software
- ◆ Any error messages displayed at the time the error occurred
- ◆ The sequence of operations that led up to the error
- ◆ Any other information you feel may be of help

Specifications

AS104

Function	AS104
System Specification	
LF Driver	4" Paper Cone with Rubber Suspension
HF Driver	20 mm PEI Dome Tweeter
Frequency Response	100–20 kHz (-10 dB)
Distortion	<= 5%
Rated Power	30Wrms / 60Wpeak
Sensitivity	86 dBSPL, @ 1 m, 1W, 1 kHz
Transformer Taps	70V (2.5W, 5W, 10W, and 20W) 100V (*, 5W, 10W, and 20W)
Compliance	
Certification	CE, WEEE, RoHs
Connectors	
Audio Inputs	5.08 mm Euroblock Connector
Environmental	
Operating Temperature	0–40°C
Humidity	0–80% RH, Non-Condensing
Storage Temperature	-20–60°C
Physical Properties	
Weight	2.20 kg (4.85 lb)
Housing	UL94-V0 ABS Plastic Baffle Zinc-Coated Steel Backcan
Dimensions (L x W x H)	21.80 × 21.80 × 13.00 cm (8.58 × 8.58 × 5.12 in)
Color	White Speaker Grille (Paintable) White Speaker Baffle
Cut-out Diameter	182 mm
In-ceiling Clearance Height	125 mm
Carton Lot	2 Pcs / Carton

Note: This product is sold in pair.

AS106

Function	AS106
System Specification	
LF Driver	6.5" Paper Cone with Rubber Suspension
HF Driver	20 mm PEI Dome Tweeter
Frequency Response	80–20 kHz (-10 dB)
Distortion	<= 5%
Rated Power	60Wrms / 1200Wpeak
Sensitivity	90 dB SPL, @ 1 m, 1W, 1 kHz
Transformer Taps	70V (7.5W, 15W, 30W, and 60W) 100V (*, 15W, 30W, and 60W)
Compliance	
Certification	CE, WEEE, RoHs
Connectors	
Audio Inputs	5.08 mm Euroblock Connector
Environmental	
Operating Temperature	0–40°C
Humidity	0 - 80% RH, Non-Condensing
Storage Temperature	-20–60°C
Physical Properties	
Weight	3.70 kg (8.15 lb)
Housing	UL94-V0 ABS Plastic Baffle Zinc-Coated Steel Backcan
Dimensions (L x W x H)	25.72 × 25.72 × 19.75 cm (10.13 × 10.13 × 7.78 in)
Color	White Speaker Grille (Paintable) White Speaker Baffle
Cut-out Diameter	221 mm
In-ceiling Clearance Height	195 mm
Carton Lot	2 Pcs / Carton
Note: This product is sold in pair.	

AS108

Function	AS108
System Specification	
LF Driver	8" Paper Cone with Rubber Suspension
HF Driver	20 mm PEI Dome Tweeter
Frequency Response	65–20kHz (-10dB)
Distortion	<= 5%
Rated Power	80Wrms/160Wpeak
Sensitivity	90dB SPL, @1m, 1W, 1kHz
Transformer Taps	70V(10W, 20W, 40W, 80W) 100V(*, 20W, 40W, 80W)
Compliance	
Certification	CE, WEEE, RoHs
Connectors	
Audio Inputs	5.08 mm Euroblock Connector
Environmental	
Operating Temperature	0–40°C
Humidity	0–80% RH, Non-Condensing
Storage Temperature	-20–60°C
Physical Properties	
Weight	5.70 kg (12.56 lb)
Housing	UL94-V0 ABS Plastic Baffle Zinc-Coated Steel Backcan
Dimensions (L x W x H)	30.90 × 30.90 × 24.80 cm (12.17 × 12.17 × 9.76 in.)
Color	White Speaker Grille (Paintable) White Speaker Baffle
Cut-out Diameter	271mm
In-ceiling Clearance Height	243mm
Carton Lot	2 Pcs / Carton
Note: This product is sold in pair.	

ATEN Standard Warranty Policy

Limited Warranty

ATEN warrants its hardware in the country of purchase against flaws in materials and workmanship for a Warranty Period of two [2] years (warranty period may vary in certain regions/countries) commencing on the date of original purchase. This warranty period includes the [LCD panel of ATEN LCD KVM switches](#). For UPS products, the device warranty is two [2] years but battery is one [1] year. Select products are warranted for an additional year (see [A+ Warranty](#) for further details). Cables and accessories are not covered by the Standard Warranty.

What is covered by the Limited Hardware Warranty

ATEN will provide a repair service, without charge, during the Warranty Period. If a product is defective, ATEN will, at its discretion, have the option to (1) repair said product with new or repaired components, or (2) replace the entire product with an identical product or with a similar product which fulfills the same function as the defective product. Replaced products assume the warranty of the original product for the remaining period or a period of 90 days, whichever is longer. When the products or components are replaced, the replacing articles shall become customer property and the replaced articles shall become the property of ATEN.

To learn more about our warranty policies, please visit our website:

<http://www.aten.com/global/en/legal/policies/warranty-policy/>

© Copyright 2024 ATEN® International Co., Ltd.
Released: 2024-03-08

ATEN and the ATEN logo are registered trademarks of ATEN International Co., Ltd. All rights reserved. All other brand names and trademarks are the registered property of their respective owners.