



Simply Better Connections

## AP106

1 x 60W Mono Hi-Z Power  
Amplifier  
User Manual

## Compliance Statements

### FEDERAL COMMUNICATIONS COMMISSION INTERFERENCE STATEMENT

This equipment has been tested and found to comply with the limits for a Class B digital service, pursuant to Part 15 of the FCC rules. These limits are designed to provide reasonable protection against harmful interference in a residential installation. Any changes or modifications made to this equipment may void the user's authority to operate this equipment. This equipment generates, uses, and can radiate radio frequency energy. If not installed and used in accordance with the instructions, may cause harmful interference to radio communications. However, there is no guarantee that interference will not occur in a particular installation. If this equipment does cause harmful interference to radio or television reception, which can be determined by turning the equipment off and on, the user is encouraged to try to correct the interference by one or more of the following measures:

- ◆ Reorient or relocate the receiving antenna.
- ◆ Increase the separation between the equipment and receiver.
- ◆ Connect the equipment into an outlet on a circuit different from that to which the receiver is connected.
- ◆ Consult the dealer or an experienced radio/TV technician for help.

The device complies with Part 15 of the FCC Rules. Operation is subject to the following two conditions: (1) this device may not cause harmful interference, and (2) this device must accept any interference received, including interference that may cause undesired operation.

**FCC Caution:** Any changes or modifications not expressly approved by the party responsible for compliance could void the user's authority to operate this equipment.



### KCC Statement

유선 제품용 / B 급 기기 (가정용 방송 통신 기기)  
이 기기는 가정용 (B 급) 전자파적합기기로서 주로 가정에서 사용하는  
것을 목적으로 하며, 모든 지역에서 사용할 수 있습니다.

**Industry Canada Statement**

This Class B digital apparatus complies with Canadian ICES-003.

**CAN ICES-003 (B) / NMB-003 (B)**

**RoHS**

This product is RoHS compliant.

---

## User Information

---

### Online Registration

Be sure to register your product at our online support center:

International	<a href="http://eservice.aten.com">http://eservice.aten.com</a>
---------------	---

---

### Telephone Support

For telephone support, call this number:

International	886-2-8692-6959
China	86-400-810-0-810
Japan	81-3-5615-5811
Korea	82-2-467-6789
North America	1-888-999-ATEN ext 4988 1-949-428-1111

### User Notice

All information, documentation, and specifications contained in this manual are subject to change without prior notification by the manufacturer. The manufacturer makes no representations or warranties, either expressed or implied, with respect to the contents hereof and specifically disclaims any warranties as to merchantability or fitness for any particular purpose. Any of the manufacturer's software described in this manual is sold or licensed *as is*. Should the programs prove defective following their purchase, the buyer (and not the manufacturer, its distributor, or its dealer), assumes the entire cost of all necessary servicing, repair and any incidental or consequential damages resulting from any defect in the software.

The manufacturer of this system is not responsible for any radio and/or TV interference caused by unauthorized modifications to this device. It is the responsibility of the user to correct such interference.

The manufacturer is not responsible for any damage incurred in the operation of this system if the correct operational voltage setting was not selected prior to operation. PLEASE VERIFY THAT THE VOLTAGE SETTING IS CORRECT BEFORE USE.

## Product Information

---

For information about all ATEN products and how they can help you connect without limits, visit ATEN on the Web or contact an ATEN Authorized Reseller. Visit ATEN on the Web for a list of locations and telephone numbers:

International	<a href="http://www.aten.com">http://www.aten.com</a>
North America	<a href="http://www.aten-usa.com">http://www.aten-usa.com</a>

## Package Contents

---

Check to make sure that all the components are in working order. If you encounter any problem, please contact your dealer.

- ◆ 1 AP106 1 x 60W Mono Hi-Z Power Amplifier
- ◆ 1 5-pin Euroblock connector with strain relief (3.5 mm)
- ◆ 1 2-pin Euroblock connector with screw lock (5.08 mm)
- ◆ 1 3-pin Euroblock connector without strain relief (3.5 mm)
- ◆ 1 power cord
- ◆ 1 foot pad set (4 pcs)
- ◆ 1 user instructions

## Contents

---

Compliance Statements .....	ii
User Information .....	iv
Online Registration .....	iv
Telephone Support .....	iv
User Notice .....	iv
Product Information .....	v
Package Contents .....	v
Contents .....	vi
About this Manual .....	vii
Conventions .....	viii

## 1. Introduction

Overview .....	1
Features .....	2
Planning the Installation .....	3
Requirements .....	3
Components .....	3
Front View .....	3
Rear View .....	3
LED Status .....	5

## 2. Hardware Setup

Connecting the AP106 Unit .....	7
---------------------------------	---

## 3. Operation

Connecting the Audio Source .....	9
Setting Up Audio Source with Unknown Output Level .....	9
2-Band Shelf Equalizer (EQ) .....	10
Amplifier Overheat Protection Behavior .....	10

## 4. CLI Commands

Overview .....	11
----------------	----

Connecting to the AP106 via RS-232.....	11
Command Syntax .....	12
Command List .....	13
read .....	13
readsensor.....	13
readstatus .....	13
reboot.....	13
standby on.....	14
standby off.....	14
standby.....	14

## **Appendix**

Safety Instructions .....	15
General.....	15
Rack Mounting .....	17
Technical Support .....	18
International .....	18
North America .....	18
Specifications .....	19
ATEN Standard Warranty Policy .....	21
Limited Warranty .....	21

## About this Manual

---

This user manual is provided to help you get the most from the AP106 unit. It covers all aspects of installation, configuration, and operation. An overview of the information found in the manual is provided below.

**Chapter 1, *Introduction*** introduces you to the 1 x 60W Mono Hi-Z Power Amplifier. Its purpose, features, installation considerations, and panel components are presented and described.

**Chapter 2, *Hardware Setup*** describes the steps that are necessary to quickly and safely set up your installation.

**Chapter 3, *Operation*** explains the audio source input operation using the 1 x 60W Mono Hi-Z Power Amplifier and its limitations.

**Chapter 1, *CLI Commands*** gives the information on command syntax and the commands that controls and configures the AP106.

**Appendix**, provides a list of safety instructions and precautions, contact information for ATEN technical support, product specifications, and other technical information.

---

### Note:

- ◆ Read this manual thoroughly and follow the installation and operation procedures carefully to prevent any damage to the unit or any connected devices.
  - ◆ This product may be updated, with features and functions added, improved or removed since the release of this manual. For an up-to-date user manual, visit <http://www.aten.com/global/en/>
-



## **Conventions**

This manual uses the following conventions:

- |   |  |
|---|--|
| <code>Monospaced</code>   | Indicates text that you should key in.   |
| [ ]   | Indicates keys you should press. For example, [Enter] means to press the <b>Enter</b> key. If keys need to be chorded, they appear together in the same bracket with a plus sign between them: [Ctrl+Alt]. |
| 1.  | Numbered lists represent procedures with sequential steps.   |
| ◆   | Bullet lists provide information, but do not involve sequential steps.   |
| >   | Indicates selecting the option (on a menu or dialog box, for example), that comes next. For example, Start > Run means to open the <i>Start</i> menu, and then select <i>Run</i> .                         |
|  | Indicates critical information.  |

This Page Intentionally Left Blank

# Chapter 1

## Introduction

### Overview

---

The AP106 is a 60W power amplifier with Hi-Z outputs capable of driving 70 V / 100 V audio systems. The support for balanced / unbalanced line level inputs enables superior sound quality and installation flexibility. Apart from the overall volume adjustment function, the built-in 2-band shelf EQ provides  $\pm 6$  dB boost / suppression of treble and bass control, offering subtle tone shaping and extra control versatility. As a result of the extra headroom this amplifier delivers, accommodating transient audio peaks and preventing distortion is never a problem to the AP106.

With Class D efficiency, the amplifier comes in a smaller, lighter enclosure, yet runs cooler comparing with other classes of amplifiers with the same amount of power. The fanless design helps eliminate operation shutdown brought by fan malfunction and ensures the amplifier not to be vulnerable to outside elements. Constructed in a compact, sealed casing, the AP106 approves of hidden placement, for instance, behind the TV, or even in the dusty environments, such as above the ceiling.

Speaking of the system protection circuit, the AP106, along with the speakers connected to it, is prevented from damages led by shorted outputs, over / under-voltage, high frequency overload, and overtemperature. Built to be energy-efficient, the amplifier enters Power Saving Mode when no audio input is detectable in 30 minutes and turns back on when a source is detected. Additional features include the front panel LEDs that indicate the device status, plus the bi-directional RS-232 serial port that allows for firmware upgrade and easy integration with ATEN's Control System, which acts as a centralized platform where hardware devices are converged to be monitored and controlled via an intuitive GUI. The AP106 is perfect for upgrading commercial or residential Pro AV systems where maintaining ultra-low distortion while exhibiting exceptional sound quality is required.

## Features

---

- ◆ A high-output power amp that delivers 60 W of power to 70 V or 100 V distributed audio systems
- ◆ Built-in 2-band shelf EQ provides  $\pm 6$  dB boost / suppression of treble and bass control
- ◆ Delivers extra headroom to accommodate transient audio peaks and prevent distortion
- ◆ Fanless design eliminates operation shutdown caused by fan malfunction and ensures the amplifier not to be vulnerable to outside elements
- ◆ Compact, sealed casing approves of hidden placement even in the dusty environments
- ◆ Provides a wide range of professional audio equipment with easy, secure connectivity:
  - ◆ Supports balanced and unbalanced line inputs on an Euroblock connector and a TRS jack (unbalanced input only)
  - ◆ Output for high-Z via an Euroblock connector
  - ◆ AC power on IEC receptacle for overseas operation
- ◆ Power Saving Mode — the AP106 shuts down when no audio input higher than -50 dBu is detectable in 30 minutes and turns back on when a source reaches -30 dBu is detected
- ◆ Integrated protection — Amp shortcut, Amp output over/under-voltage, high frequency overload, and overtemperature protection
- ◆ Bi-directional RS-232 serial port allows for firmware upgrade and easy integration with ATEN's Control System
- ◆ Class D high efficiency and energy saving construction
- ◆ Perfect for upgrading commercial or residential Pro AV systems where maintaining ultra-low distortion while exhibiting exceptional sound quality is required

## Planning the Installation

### Requirements

Prepare the following before installing the AP106 unit:

- ◆ 1 set of ceiling loudspeakers
- ◆ 1 or more audio source devices

## Components

### Front View

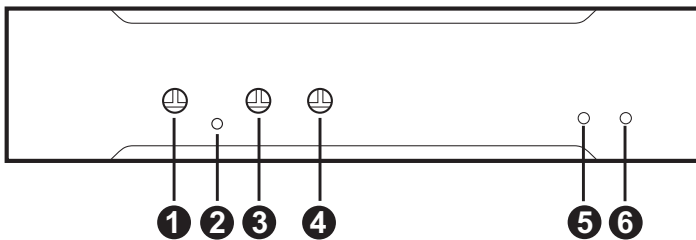

### Rear View

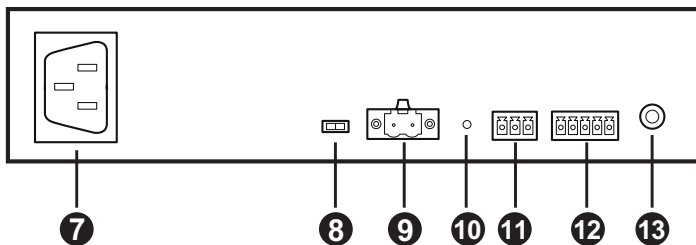

No.	Component	Description
1	volume control	Adjusts the audio output volume.
2	signal / clip LED	Lights to indicate the audio signal status. See <i>LED Status</i> , page 5.

---

No.	Component	Description
3	bass control	Adjusts the bass level.
4	treble control	Adjusts the treble level.
5	standby LED	Lights to indicate the unit is in standby mode. See <i>LED Status</i> , page 5.
6	power LED	Lights to indicate the unit is powered on. See <i>LED Status</i> , page 5.
7	power socket	Connects to the power cord.
8	impedance switch	Adjusts the impedance between 70V and 100V.
9	speaker output channel (2-pin Euroblock connector)	Connects to a set of loud speakers such as AS104 / AS106.
10	reset button	Press this button to reset the MCU of the unit.
11	RS-232 serial port (3-pin Euroblock connector)	Connects to an ATEN controller for remote control.
12	audio input channel (5-pin Euroblock connector)	Connects to an audio source.
13	audio input channel (3.5 mm TRS)	Connects to an audio source.

---

## LED Status

You can find the unit's LEDs on the front panel as illustrated below. See the table below for details on the LED indication.

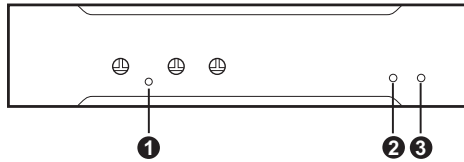

No.	LED	Indication	Description
1	Signal/Clip LED	Lights green	The audio signal strength is > -50 dBu.
		Lights red	<ul style="list-style-type: none"> <li>◆ The audio signal strength is &gt; +4 dBu Balanced.</li> <li>◆ The audio signal strength is &gt; -10 dBu Unbalanced.</li> </ul>
		Off	There is no audio signal.
2	standby LED	Lights amber	The unit is in standby mode and audio strength is < -30 dBu.
		Blinks amber	The unit is in overheat protection mode. See , page 10.
		Off	The unit is running and not in the standby mode.
3	power LED	Lights green	The unit is powered on.
		Off	The unit is powered off.

**Note:**

- ◆ The signal clip, standby and power LEDs blink at the same time to indicate that the firmware upgrade is in progress.

This Page Intentionally Left Blank



# Chapter 2

## Hardware Setup



1. Please review the safety information regarding the placement of this device in *Safety Instructions*, page 15.
2. Do not power on the AP106 until all the necessary hardware is connected.

### Connecting the AP106 Unit

Follow the steps below to connect the AP106 to audio source devices, a set of loud speakers, and an ATEN controller.

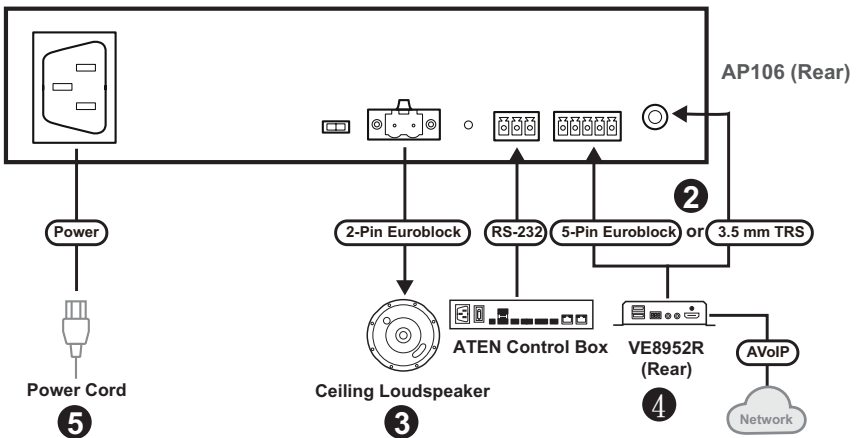

1. Make sure all the equipment you are connecting to the unit is turned off and disconnected from the power source.
2. Connect your audio sources to the audio input channels. When both audio input channels are being used, the unit output the audio source from the 3.5 mm TRS as a priority.

---

**Note:** The unit sums the left and right signals from the supplied 5-pin Euroblock and TRS jack individually.

---

3. Connect the speakers to the unit's speaker output channel.

---

**Note:**

- ◆ To avoid damaging the amplifier, please connect the wires to your speakers first, and then connect the speaker output channel using the supplied 2-pin Euroblock connector with screw lock (5.08 mm).
  - ◆ For safety and better audio quality, AWG 16 or thicker speaker wires are highly recommended.
- 

4. (Optional) To control the unit using an ATEN controller, connect the ATEN controller to the unit's RS-232 serial port.
5. Connect the supplied power cord to the unit's power socket after powering on all other audio equipment.
6. Adjust the volume, bass, and treble from the unit's front panel.

# Chapter 3 Operation

## Connecting the Audio Source

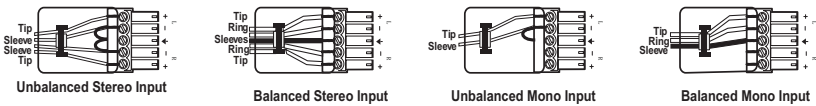

Please follow the illustrations below to connect your audio source to the audio input channels using the supplied 5-pin Euroblock connector with strain relief (3.5 mm).

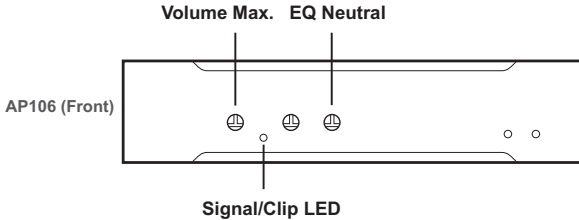

## Setting Up Audio Source with Unknown Output Level

Please refer to the diagram and table below to set up unbalanced input level from a headphone output. Remember to set and keep the AP106's volume to the max level.



AMP LED Status	Audio Source Maneuver
SIGNAL CLIP 	Sets the PC Volume at minimum position to play a constant tone from PC. Pink noise is preferred.
SIGNAL CLIP 	Slowly increase the source volume till a solid green LED lit up. This volume position indicates that the unit is receiving -50 dBu.
SIGNAL CLIP 	Keep increasing the source volume after the solid green LED lit up and then stop when there is a blinking red LED. This volume position indicates that the unit is receiving normal input level.

## 2-Band Shelf Equalizer (EQ)

See the diagram below to see the line curves when adjusting the treble and bass to the unit.

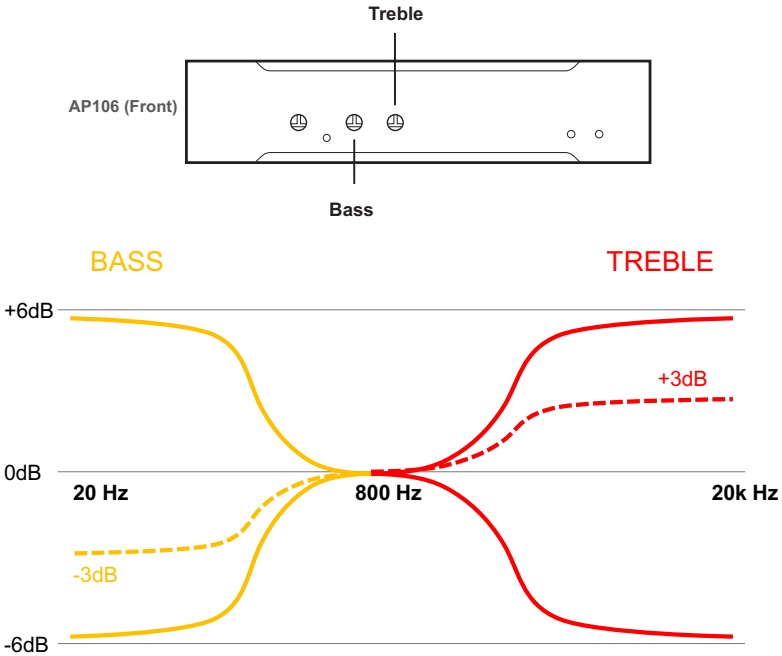

## Amplifier Overheat Protection Behavior

The overeat protection activates when the unit is getting too hot. The unit will mute for 1 minute and then recheck the thermal threshold.

- ◆ Under Threshold: The unit resume back to its working mode.
- ◆ Over Threshold: The unit goes into the overheat protection mode and the standby LED blinks in amber. In the overheat protection mode, the wake up function is disabled. To wake up the unit from overheat protection mode, you can do one of the following:
  - ◆ via the RS-232 command via an ATEN control system.
  - ◆ Power on and off the unit.

# Chapter 1

## CLI Commands

### Overview

---

The AP106 can be configured and controlled via RS-232 commands when connected to a host computer or other device, such as a control system. This chapter provides information on command syntax and the commands that controls and configures the AP106.

### Connecting to the AP106 via RS-232

---

1. Connect a host computer or control system to the RS-232 Serial port on the AP106 unit.
2. Download and install controller software that supports RS-232 serial control and the operation system of your controller PC.
3. Execute the software and configure the connection settings to the following:
  - ◆ Baud rate: **19200**
  - ◆ Data bits: **8**
  - ◆ Stop bits: **1**
  - ◆ Parity: **None**
  - ◆ Flow control: **None**
4. When a session is established with the AP106, you can control and configure the AP106 via RS-232 commands. For more information on commands, see:
  - ◆ *Command Syntax*, page 12
  - ◆ *Command List*, page 13

## Command Syntax

- ◆ The general form of a command is:

```
command parameter<argument> {one|two|three}
```

Notation	Description
<b>command</b>	The name of the command is shown in bold.
parameter	Indicates the name of the parameter.
<argument>	Indicates the name of the value or the information that the user must provide. Only type the information in the angle brackets, not the brackets themselves.
[ ]	Indicates optional items. Only type the information in the brackets, not the brackets themselves.
{ }	Indicates a set of choices from which the user must choose one.
	Indicates two or more mutually exclusive choices in a command line. Only type one of the choices in the command line, not the symbol.

- ◆ If you have two or more parameters, the order of these parameters among themselves does not affect the result of the operation. For example, both of the following commands execute the same task:

```
command name + parameter 1 + parameter 2
```

```
command name + parameter 2 + parameter 1
```

## Command List

---

Use the following commands to control and configure the AP106 via or RS-232.

### read

- ◆ **Function**

To show the unit's firmware version, the anomalous event logs, and the amplifier output status (signal / clip).

- ◆ **Syntax**

```
read
```

### readsensor

- ◆ **Function**

To show the unit's system temperature.

- ◆ **Syntax**

```
readsensor
```

### readstatus

- ◆ **Function**

To show the unit's anomalous event logs and the amplifier output status (signal / clip).

- ◆ **Syntax**

```
readstatus
```

### reboot

- ◆ **Function**

To switch the unit off and then start it again.

- ◆ **Syntax**

```
reboot
```

**standby on**◆ **Function**

To put the unit to standby mode which is a low-power state.

◆ **Syntax**

`standby on`

**standby off**◆ **Function**

To wake up the unit from standby mode.

◆ **Syntax**

`standby off`

**standby**◆ **Function**

To show the standby status of the unit.

◆ **Syntax**

`standby`



## Safety Instructions

---

### General

- ◆ This product is for indoor use only.
- ◆ Read all of these instructions. Save them for future reference.
- ◆ Follow all warnings and instructions marked on the device.
- ◆ Do not place the device on any unstable surface (cart, stand, table, etc.). If the device falls, serious damage will result.
- ◆ Do not use the device near water.
- ◆ Do not place the device near, or over, radiators or heat registers.
- ◆ The device cabinet is provided with slots and openings to allow for adequate ventilation. To ensure reliable operation, and to protect against overheating, these openings must never be blocked or covered.
- ◆ The device should never be placed on a soft surface (bed, sofa, rug, etc.) as this will block its ventilation openings. Likewise, the device should not be placed in a built in enclosure unless adequate ventilation has been provided.
- ◆ Never spill liquid of any kind on the device.
- ◆ Unplug the device from the wall outlet before cleaning. Do not use liquid or aerosol cleaners. Use a damp cloth for cleaning.
- ◆ The device should be operated from the type of power source indicated on the marking label. If you are not sure of the type of power available, consult your dealer or local power company.
- ◆ To prevent damage to your installation it is important that all devices are properly grounded.
- ◆ Do not allow anything to rest on the power cord or cables. Route the power cord and cables so that they cannot be stepped on or tripped over.
- ◆ Position system cables and power cables carefully; Be sure that nothing rests on any cables.
- ◆ Never push objects of any kind into or through cabinet slots. They may touch dangerous voltage points or short out parts resulting in a risk of fire or electrical shock.

- ◆ Do not attempt to service the device yourself. Refer all servicing to qualified service personnel.
- ◆ If the following conditions occur, unplug the device from the wall outlet and bring it to qualified service personnel for repair.
  - ◆ The power cord or plug has become damaged or frayed.
  - ◆ Liquid has been spilled into the device.
  - ◆ The device has been exposed to rain or water.
  - ◆ The device has been dropped, or the cabinet has been damaged.
  - ◆ The device exhibits a distinct change in performance, indicating a need for service.
  - ◆ The device does not operate normally when the operating instructions are followed.
- ◆ Only adjust those controls that are covered in the operating instructions. Improper adjustment of other controls may result in damage that will require extensive work by a qualified technician to repair.
- ◆ To prevent electric shock, please do not remove the top cover as there are no user serviceable parts inside. Please refer to qualified service personnel for servicing.
- ◆ To completely disconnect this apparatus from the AC mains, disconnect the power supply cord plug from the AC receptacle.

## **Rack Mounting**

- ◆ Before working on the rack, make sure that the stabilizers are secured to the rack, extended to the floor, and that the full weight of the rack rests on the floor. Install front and side stabilizers on a single rack or front stabilizers for joined multiple racks before working on the rack.
- ◆ Always load the rack from the bottom up, and load the heaviest item in the rack first.
- ◆ Make sure that the rack is level and stable before extending a device from the rack.
- ◆ Use caution when pressing the device rail release latches and sliding a device into or out of a rack; the slide rails can pinch your fingers.
- ◆ After a device is inserted into the rack, carefully extend the rail into a locking position, and then slide the device into the rack.
- ◆ Do not overload the AC supply branch circuit that provides power to the rack. The total rack load should not exceed 80 percent of the branch circuit rating.
- ◆ Make sure that all equipment used on the rack – including power strips and other electrical connectors – is properly grounded.
- ◆ Ensure that proper airflow is provided to devices in the rack.
- ◆ Ensure that the operating ambient temperature of the rack environment does not exceed the maximum ambient temperature specified for the equipment by the manufacturer.
- ◆ Do not step on or stand on any device when servicing other devices in a rack.

## Technical Support

---

### International

- ◆ For online technical support – including troubleshooting, documentation, and software updates: <http://support.aten.com>
- ◆ For telephone support, see *Telephone Support*, page iv:

### North America

Email Support		<a href="mailto:support@aten-usa.com">support@aten-usa.com</a>
Online Technical Support	Troubleshooting Documentation Software Updates	<a href="http://www.aten-usa.com/support">http://www.aten-usa.com/support</a>
Telephone Support		1-888-999-ATEN ext 4988

When you contact us, please have the following information ready beforehand:

- ◆ Product model number, serial number, and date of purchase
- ◆ Your computer configuration, including operating system, revision level, expansion cards, and software
- ◆ Any error messages displayed at the time the error occurred
- ◆ The sequence of operations that led up to the error
- ◆ Any other information you feel may be of help

## Specifications

Function	AP106
<b>System Specification</b>	
Rated Power	60Wrms, 120Wpeak
Distortion	THD+N: <0.1%, 1 kHz, 3 dB before clipping
Frequency Response	80–20 kHz, 0/-3 dB @ 70V, 1W
Sensitivity	Balanced: + 4 dB Unbalanced: -10 dBV (0 dBu = 0.775 Vrms, 0 dBV = 1 Vrms)
Amplifier Type	Class D
HPF	80 Hz, -12 dB/Oct
<b>Audio Inputs</b>	
Interfaces	5-pin, 3.5 mm Euroblock (Bal/Unbal) 3.5 mm TRS Unbalanced Phone Jack (Priority)
Impedance	Balanced: 20 k $\Omega$ Unbalanced: 10 k $\Omega$
Detect Threshold	-50 dBu
<b>Audio Outputs</b>	
Interfaces	1 $\times$ 2-pin 5.08 mm Euroblock
Impedance	Minimum Load 70V: 80 $\Omega$ 100V: 160 $\Omega$
<b>Audio Effects</b>	2-band Shelf EQ, +/-6 dB
<b>Protection</b>	Output Shortcut AMP Output Over / Under Voltage High Frequency Overload Thermal Protect
<b>Communication</b>	
RS-232	Connector: 3-pin, 3.5 mm, Terminal Block
Baud Rate	Baud rate and protocol: Baud Rate: 19200 Data Bits: 8 Stop Bits: 1 Parity: No Flow Control: No
<b>Power</b>	

Function	AP106
Power Consumption	AC110V; 84.54W; 288BTU/h AC220V; 83.75W; 285BTU/h  <b>Note:</b> <ul style="list-style-type: none"> <li>◆ Watts: represents the typical power consumption of the device with no external loading</li> <li>◆ BTU/h: represents the power consumption of the device when it is fully loaded</li> </ul>
Maximum Input Power Rating	100 - 240V ~, 50 / 60 Hz, 1A
<b>Compliance</b>	
Certification	FCC, CE, UKCA
<b>Environmental</b>	
Operating Temperature	0–40°C
Storage Temperature	-20–60°C
Humidity	0–80% RH, Non-Condensing
<b>Physical Properties</b>	
Housing	Metal
Weight	1.23 kg (2.71 lb)
Dimensions (L x W x H)	1/2 Rack Mount Unit 20.00 x 15.72 x 4.40 cm (7.87 x 6.19 x 1.73 in)

**Note:** The Rack / surface mount kits are sold separately, please contact your ATEN dealer or go to ATEN website for available accessories and product information.

## **ATEN Standard Warranty Policy**

---

### **Limited Warranty**

ATEN warrants its hardware in the country of purchase against flaws in materials and workmanship for a Warranty Period of two [2] years (warranty period may vary in certain regions/countries) commencing on the date of original purchase. This warranty period includes the [LCD panel of ATEN LCD KVM switches](#). For UPS products, the device warranty is two [2] years but battery is one [1] year. Select products are warranted for an additional year (see [A+ Warranty](#) for further details). Cables and accessories are not covered by the Standard Warranty.

### **What is covered by the Limited Hardware Warranty**

ATEN will provide a repair service, without charge, during the Warranty Period. If a product is defective, ATEN will, at its discretion, have the option to (1) repair said product with new or repaired components, or (2) replace the entire product with an identical product or with a similar product which fulfills the same function as the defective product. Replaced products assume the warranty of the original product for the remaining period or a period of 90 days, whichever is longer. When the products or components are replaced, the replacing articles shall become customer property and the replaced articles shall become the property of ATEN.

To learn more about our warranty policies, please visit our website:  
<http://www.aten.com/global/en/legal/policies/warranty-policy/>

© Copyright 2024 ATEN® International Co., Ltd.  
Released: 2024-04-11

ATEN and the ATEN logo are registered trademarks of ATEN International Co., Ltd. All rights reserved. All other brand names and trademarks are the registered property of their respective owners.