

Process Control Equipment for Hazardous Locations 7M26 UL913

These **TRIPLEX** and **QUADRAPLEX CONTROLLERS** are available with either Sequence-On-Simultaneous-Off (**SOSO**) or First-On-First-Off (**FOFO**) output logic. The special function models are differentiated by a rotary switch that allows any output to be locked as the lead load or any one load to be omitted while sequencing only the remaining loads. In addition to load omission and lead selection, the expandable model can be set for 2, 3, or 4 load operation with either SOSO or FOFO logic.

All models feature **INTRINSICALLY SAFE INPUTS** and logic that allows the outputs to operate properly even if one of the inputs fails to open or close. For example: if the off switch fails to close, the lead load will not energize until both the lead and the lag switches close. An inrush delay on all models reduces line sags by preventing multiple loads from energizing simultaneously.

Alternating Controllers

- 3 and 4 Load Output Models
- Intrinsically Safe Inputs

SPECIFICATIONS

CONTROL VOLTAGE	24 or 120 VAC ±10%, 50/60 Hz
SWITCH VOLTAGE	5.1 Volts open circuit
SWITCH CURRENT	10 μAmps short circuit
POWER REQUIRED	2.5 VA
SENSITIVITY	100 k ohm
ISOLATION	2500V Input to Output
DUTY CYCLE	Continuous
RESPONSE	Power Up < 1 SEC Operate < 25 mSEC (switch closure) Inrush 5 SEC Release < 150 mSEC
CONTACT RATING	All channels, SPST-N.O., 5 Amps per channel @ 24 or 120 VAC, Resistive; 278 VA, Inductive
LED INDICATORS	ON when corresponding output is ON
LIFE EXPECTANCY	Mechanical 20 Million Operations Electrical 50,000 Operations
TEMPERATURE RATING	Operate -4° to 131°F (-20° to +55°C) Storage -40° to 185°F (-40° to +85°C)
TERMINATIONS	(12) #8-32 Screw terminals with pressure clamps
ENCLOSURE	Style "E" Surface mount
WEIGHT	16 oz.

DIMENSIONS (INCHES)

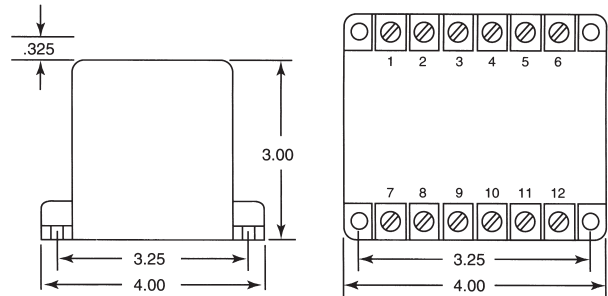

MODEL NUMBER

MODEL NUMBER	ARM			E	
CONTROL VOLTAGE	24 VAC	24A			
	120 VAC	120A			
NO. OF LOADS	OUTPUT LOGIC	SPECIAL FUNCTIONS			
3	SOSO	none	A		
3	FOFO	none	B		
3	SOSO	Omit/Lead Select	C		
3	FOFO	Omit/Lead Select	D		
4	SOSO	none	G		
4	FOFO	none	H		
ENCLOSURE STYLE			E		
MOUNT	No Suffix Surface Mount				
	P Suffix Panel Mount				P

The ARM Series is UL Listed under UL File Number E151578.

The **ARM-120-AAE** and **ARM-120-ABE** Triplex Controllers have four switch inputs and three load outputs. The inputs are designated off, lead, lag and 2nd lag. If the off switch fails to close, the lead load will not energize until both the lead and lag switches close. De-energization of the loads depends on the output logic of the selected controller.

ARM-120-AAE (SOSO): The **ARM-120-AAE** has sequence-on simultaneous off output logic. As the 2nd lag, lag and lead switches open, the loads remain energized. When the off switch opens, all three loads de-energize simultaneously. If any switch fails to open, the loads still de-energize when the off switch opens. The lead advances one position each time the loads de-energize.

ARM-120-ABE (FOFO): The **ARM-120-ABE** has first-on-first-off output logic. When the 2nd lag switch opens, all three loads remain energized. The lag switch opens next, and the lead load de-energizes. When the lead switch opens, the lag load de-energizes. Finally, the off switch opens, and the second lag load de-energizes. At the end of each cycle the lead advances one position for each load energized during the cycle. For example: if loads one and two cycle on and off, the lead will advance two positions. Load three will be the lead load for the next cycle.

The **ARM-120-ACE (SOSO)** and **ARM-120-ADE (FOFO)** Special Function Triplex Controllers have the same features and operations as the ARM-120-AAE and ARM-120-ABE respectively with the addition of an eight-position field selection switch. The switch allows any one load to be omitted from the sequence or locked in the lead position. An automatic test mode is also provided for system verification and troubleshooting.

LOAD OMIT MODE: One load may be omitted from the sequence for general or emergency maintenance while alternating the remaining loads.

LEAD SELECT MODE: The controller may be locked into a desired sequence to equalize motor run time.

AUTOMATIC TEST MODE: The controller energizes the loads one at a time for five second intervals.

OPERATION TRIPLEX CONTROLLERS

Intrinsically safe equipment and wiring is equipment and wiring which is incapable of releasing sufficient electrical or thermal energy under normal or abnormal conditions to cause ignition of a specific hazardous atmospheric mixture in its most ignitable concentration. Intrinsically safe terminations and wiring may be brought into any hazardous location of any group classification for which it is accepted without requiring explosion-proof housing or other means of protection.

Hazardous locations are classified by the National Electrical Code according to the level of hazard that may exist in the area. A hazardous location is designated by its class, group and division. The class and group specify the specific hazardous substances that may exist in the classified location.

- Class I, Groups A through D – Flammable gasses
- Class II, Groups E through G – Combustible dusts
- Class III, Easily ignitable fibers or flyings

The division indicates the conditions under which the hazardous substance may be present.

- Division I—Hazardous substances exist continuously or intermittently under normal operating conditions.
- Division II – Hazardous substances exist within closed containers or systems from which they can escape only in case of accidental rupture or breakdown.

WIRING

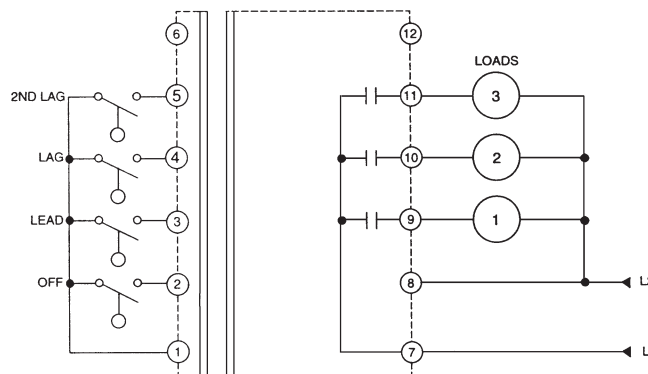

FIELD SELECTION SWITCH

POS.	FUNCTION
0	NORMAL
1	1 2 3
2	2 3 1
3	3 1 2
4	OMIT L1
5	OMIT L2
6	OMIT L3
7	TEST

OPERATION QUADRAPLEX CONTROLLERS

The **ARM-120-AGE** and **ARM-120-AHE Quadrplex Controllers** have five switch inputs and four load outputs. The inputs are designated off, lead, lag, 2nd lag, and 3rd lag. With the off switch closed, the loads energize in sequence upon closure of the lead, lag, 2nd lag, and 3rd lag inputs. If the off switch fails to close, the lead load will not energize until both the lead and lag switches close. De-energization of the loads depends on the output logic of the selected controller.

ARM-120-AGE (SOSO): The **ARM-120-AGE** has sequence-on simultaneous off output logic. As the 3rd lag, 2nd lag, lag and lead switches open, the loads remain energized. When the off switch opens, all four loads de-energize simultaneously. If any switch fails to open, the loads still de-energize when the off switch opens. The lead advances one position each time the loads de-energize.

ARM-120-AHE (FOFO): The **ARM-120-AHE** has first-on-first-off output logic. When the 3rd lag switch opens, all four loads remain energized. The 2nd lag switch opens next, and the lead load de-energizes. When the lag switch opens, the lag load de-energizes. Next, the lead switch opens, and the 2nd lag load de-energizes. Finally, the off switch opens, and the 3rd lag load de-energizes. At the end of each cycle the lead advances one position for each load energized during the cycle. For example: if loads one and two cycle on and off, the lead will advance two positions. Load three will be the lead load for the next cycle.

WIRING

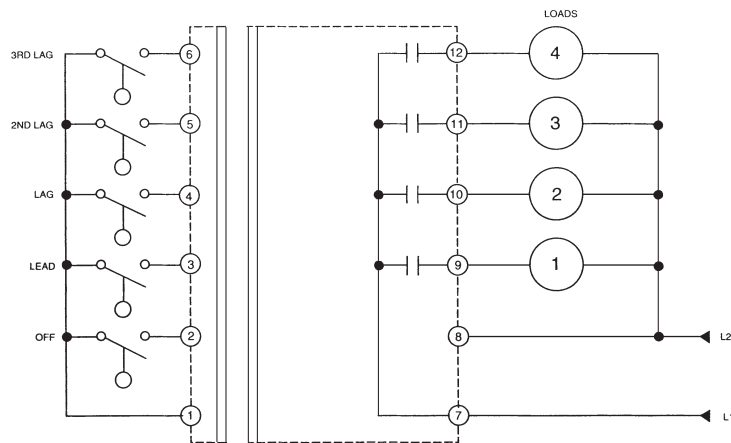

FOFO OPERATION

STEP 1

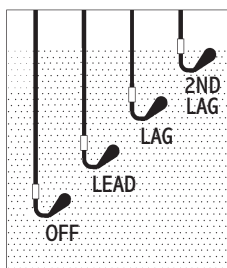

This example continues from SOSO operation step four. With all float switches closed, all loads are energized.

STEP 2

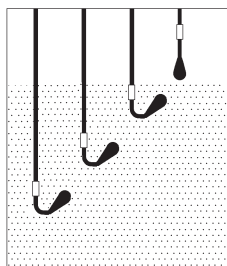

As the fluid level falls, the 2nd lag switch opens. All loads remain energized. Each float switch in descending order acts as the OFF switch for the preceding float.

STEP 3

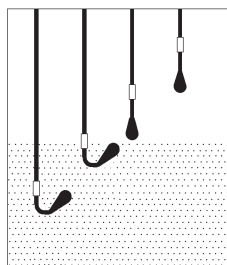

When the lag switch opens, load 1 de-energizes. Loads 2 and 3 remain energized.

STEP 4

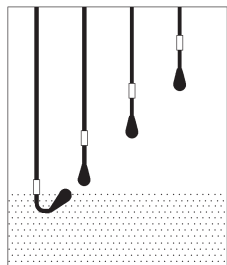

When the lead switch opens, load 2 de-energizes. Load 3 is held on by the OFF switch.

STEP 5

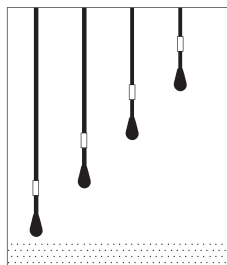

When the OFF switch opens, load 3 de-energizes and the lead advances three positions. At the end of each cycle the lead advances one position for each load energized during the cycle. This particular example reverts back to SOSO OPERATION 1-4 wherein load 1 would again be the lead load.

SOSO OPERATION

STEP 1

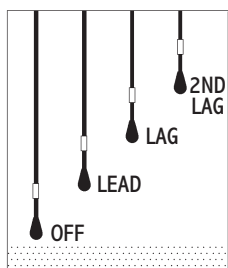

This example illustrates the normal operation of the Triplex Controller in a pump down application with four normally open dry float switches. The switches are designated off, lead, lag, and 2nd lag. The example begins with all switches open and all loads de-energized.

STEP 2

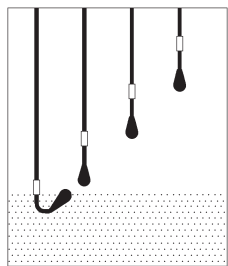

As the fluid level rises, the OFF switch closes, no loads are energized.

STEP 3

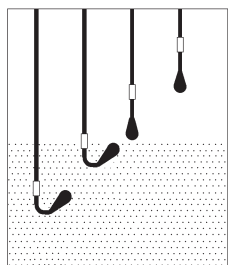

If the fluid level continues to rise, the lead switch closes and load 1 energizes.

STEP 4

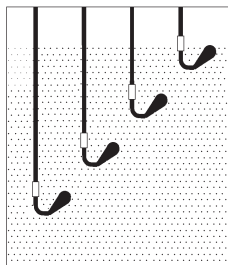

As the fluid level continues to rise each successive float switch closure sequentially energizes a corresponding load.

STEP 5

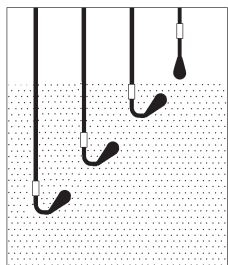

When the fluid level falls and each float switch opens, the loads remain energized so long as the OFF switch remains closed. No external auxiliary contacts are required to accomplish this latch feature.

STEP 6

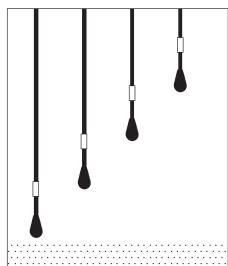

When the fluid level falls below the OFF switch, all loads simultaneously de-energize, and the alternating logic advances one position. The next rise and fall in fluid level and successive operation of load switches will result in the SOSO load operation as follows: 2-3-1, 3-1-2, and back to 1-2-3 as in Step 1.