

DPH Series digital display pressure sensor(Analog output)



Specification

Model	DPHN2(3)(B)-01 / DPHP2(3)(B)-01 / DPHN2(3)(B)-10 / DPHP2(3)(B)-10	
Input power	Voltage	12~24 VDC ± 10% Ripple(p-p) < 10%
	Current Consumption	40mA or less
Pressure range	Fluid	Non-corrosive gas
	Measurement range	DPHN2(3)(B)-01/DPHP2(3)(B)-01 : -15psi~15psi DPHN2(3)(B)-01/DPHP2(3)(B)-10 : -15psi~150psi
	Withstand pressure	DPHN2(3)(B)-01/DPHP2(3)(B)-01 : -15psi~22psi DPHN2(3)(B)-01/DPHP2(3)(B)-10 : -15psi~175psi
	Measurement error	±2%F.S. , ±1digit(Temperature:25±3°C)
	Repetitive accuracy	±0.2%F.S.
	Temperature error	±3%F.S.(Base 25°C , Range 0 to 50°C)
	Display	Type
Display	Output	LCD Analog and Double row LCD display
	Color	2-color LCD (Red/Green)
	Output model	Basic mode, Hysteresis mode, Window comparator mode Suction check mode, Leakage mode
Switch Output	Transistor output	NPN:Maximum applied voltage 30V/100mA,Retained voltage <2V PNP:Maximum applied voltage 30V/100mA,Retained voltage <2V
	Analog Voltage Output	1 to 5V±3% F.S. (Minimum load impedance 1kΩ)
	Analog Current Output	4 to 20mA±3% F.S.(Range of Load impedance is 50 ~ 260Ω)
	Output-delay time	2ms, 20ms, 100ms, 500ms, 1000ms, 2000ms
Pressure Unit	DPHN2(3)(B)-01 DPHP2(3)(B)-01	kPa, kgf/cm ² , bar, psi, mmHg, inHg
	DPHN2(3)(B)-10 DPHP2(3)(B)-10	MPa, kPa, kgf/cm ² , bar, psi, cmHg, inHg
Vibration resistance		10 to 500Hz with 10mm Amplitude in X, Y, Z directions for 2hrs
Impact resistance		Maximum 100m/s ² , X, Y, Z directions 3 times each
Operating Temp. range		0~50°C
Stored Temp. range		-20~65°C
Humidity range		35%~80% RH(No condensation)

Symbol



On-line Manual

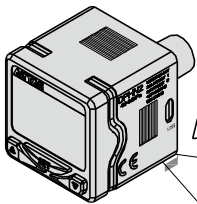

QR Code



Get full documentation

1. Install QR Code APP, and scan the QR Code on the shell.
2. Documentation website, <http://www.airtac.net/OM/main.htm>.

Ordering code

DPH N2 □ - 01 020 □

① ② ③ ④ ⑤ ⑥

① Model	② Output type	③ Electrical entry	④ Measurement range	⑤ Lead wire length	⑥ Piping specifications
DPH: Digital Display Pressure Sensor (Analog output)	N2: NPN+Analog voltage output(1-5V) P2: PNP+Analog voltage output(1-5V) N3: NPN+Analog current output(4-20mA) P3: PNP+Analog current output(4-20mA)	Space: Terminal B: Grommet [Note]	01: -100kPa~100kPa 10: -100kPa~1,000kPa	020: Length 2m 030: Length 3m 050: Length 5m	Blank: PT1/8 with M5 female thread T: NPT1/8 with 10-32UNF female thread G: G1/8 with M5 female thread

[Note] The safety grade of grommet type is IP63.

Dimensions

Terminal

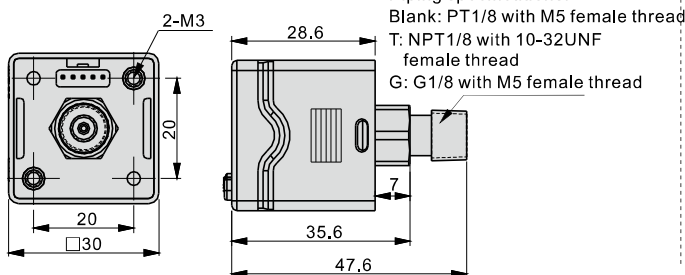

Grommet

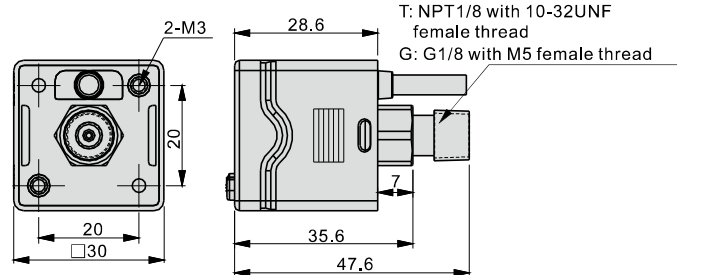

Preparation unit—Accessories

DPH Series digital display pressure sensor(Analog output)

User interface Instruction

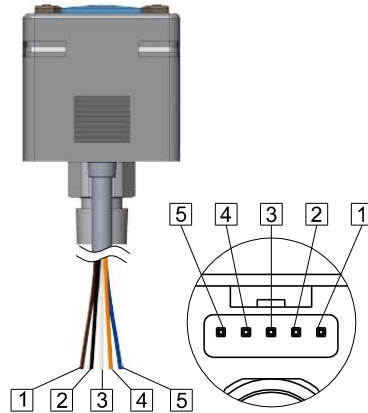
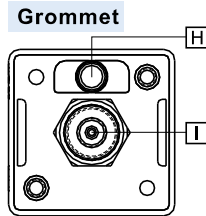
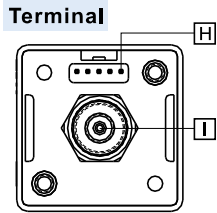
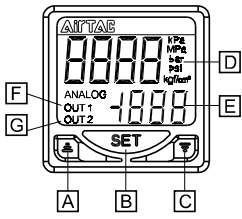

No.	Item
A	Value up button
B	Setting button
C	Value Down button
D	Pressure display area
E	Set pressure display area
F	Output 1 indicator light
G	Output 2 indicator light
H	Power and signal connector
I	Pressure input
1	DC(+) input (Brown)
2	OUT1 (Black)
3	OUT2 (White)
4	Analog/Zero (Orange)
5	DC(-) input (Blue)

Connection Example

NPN Output

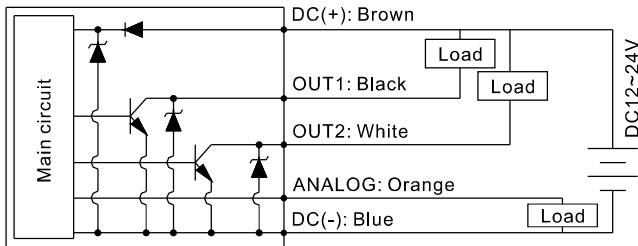

Zero-shift Input

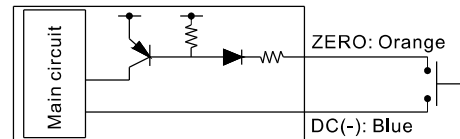

PNP Output

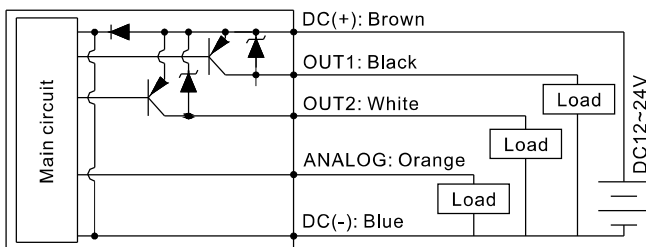

User Interface Instructions

1. Mode switch

Install the connector
Turn on the power

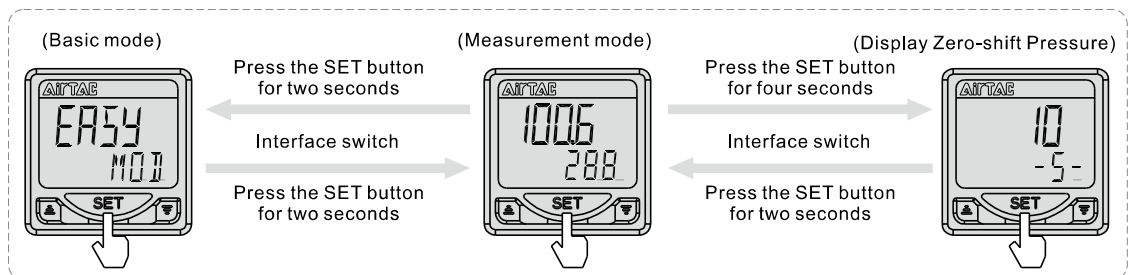
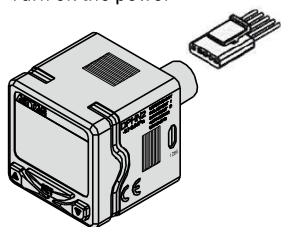

DPH Series digital display pressure sensor(Analog output)

2. Measurement mode

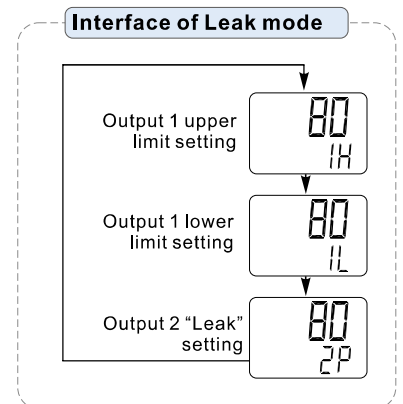
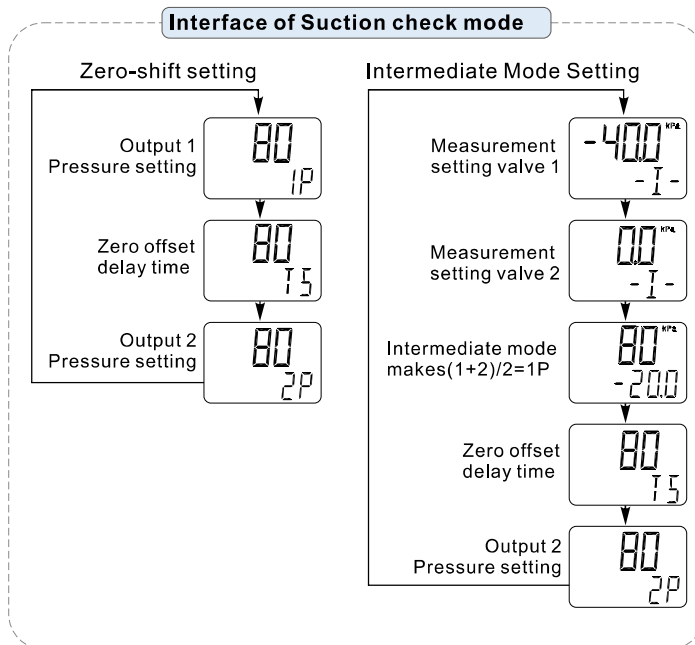
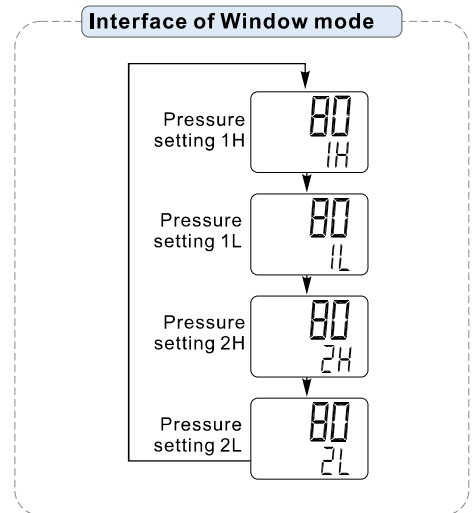
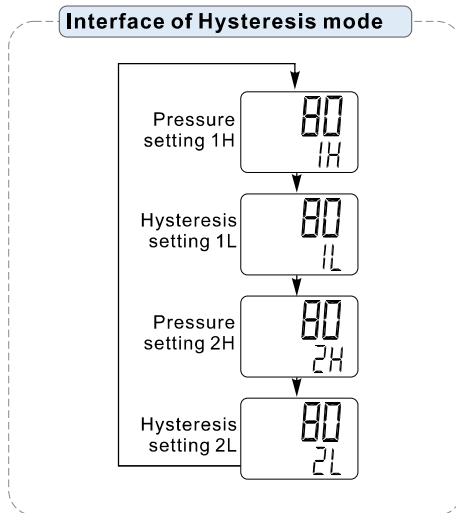
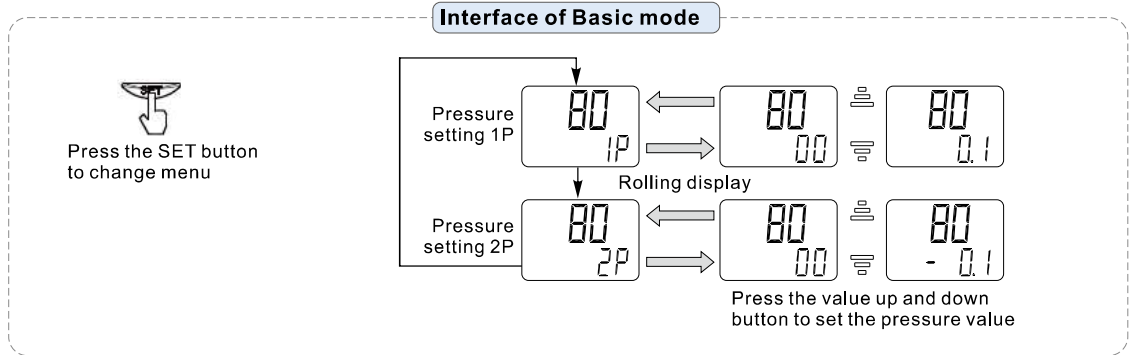
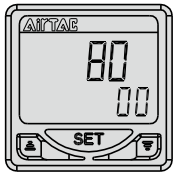

Preparation unit—Accessories

DPH Series digital display pressure sensor(Analog output)

3. Basic mode

Interface of Basic mode

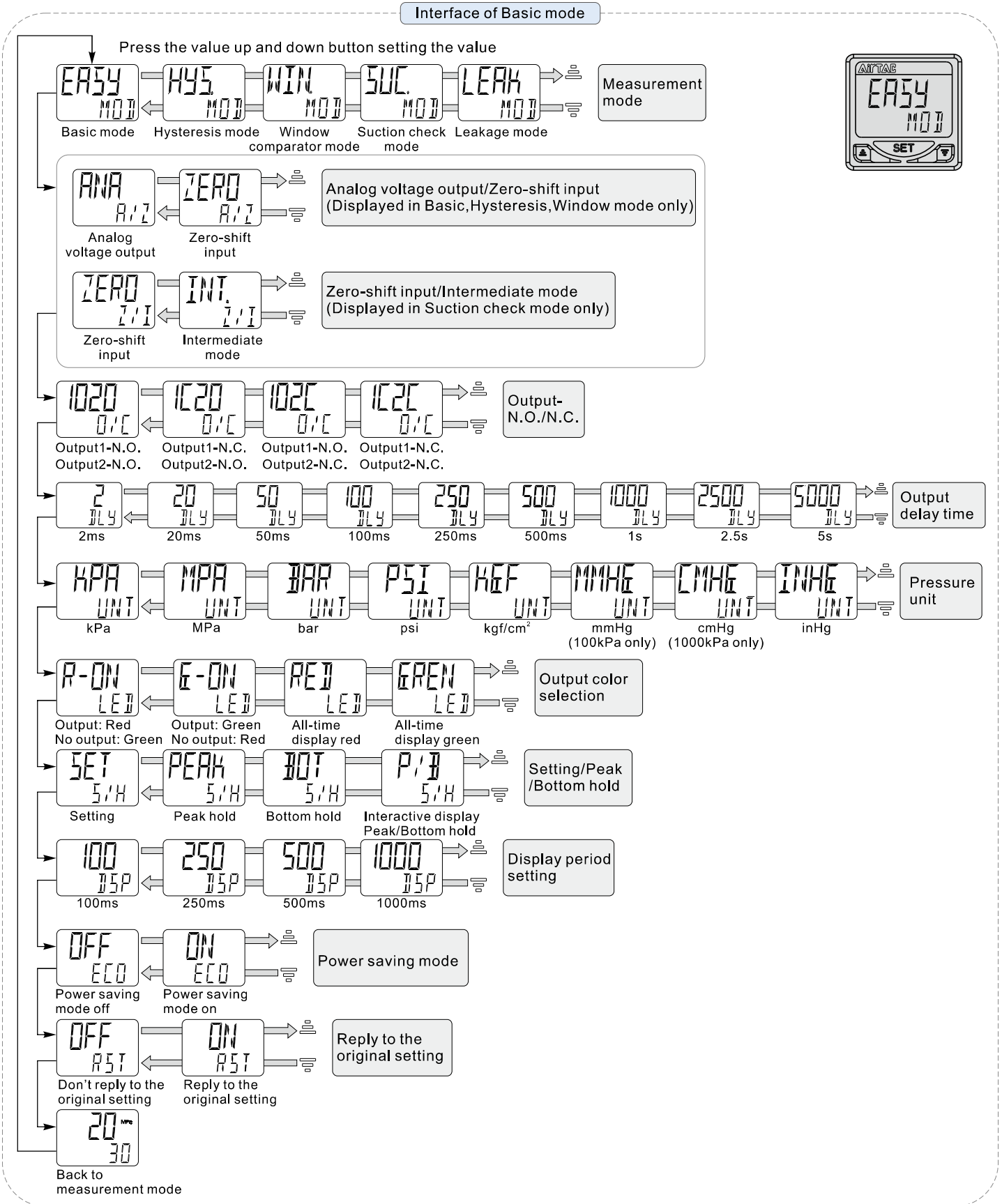

DPH Series digital display pressure sensor(Analog output)

Output mode description

1. Basic mode: Set the pressure value 1P/2P. When the applied pressure value is greater than 1P/2P + hysteresis value, the display will ON. When the applied pressure value is less than P + hysteresis value, the display will OFF.

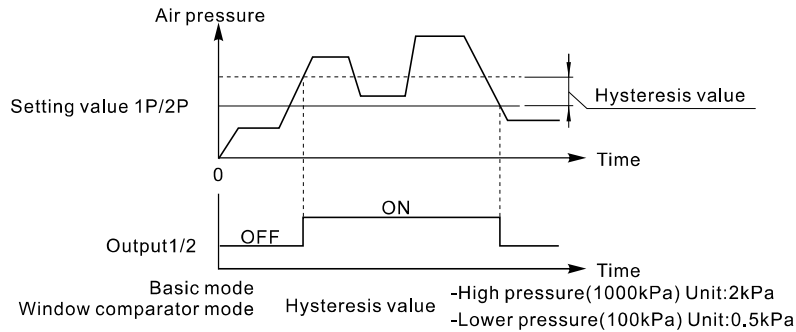

2. Hysteresis mode: Set the pressure value 1H/2H/1L/2L. When the applied pressure value is greater than 1H/2H, the display will ON. When the applied pressure is less than 1L/2L, the display will OFF.

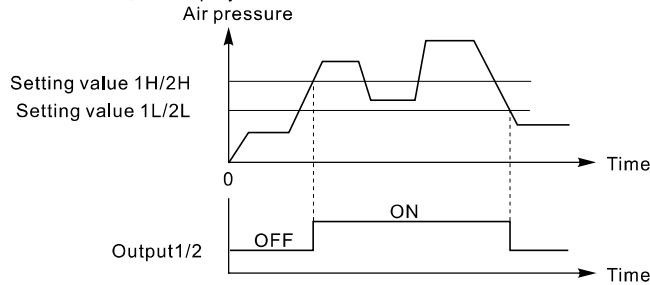

3. Window comparator mode: Set the pressure value H/L. When the pressure is greater than the H value or less than the L value, the output is OFF; when the air pressure is greater than the L value and less than the H value, the output is ON.

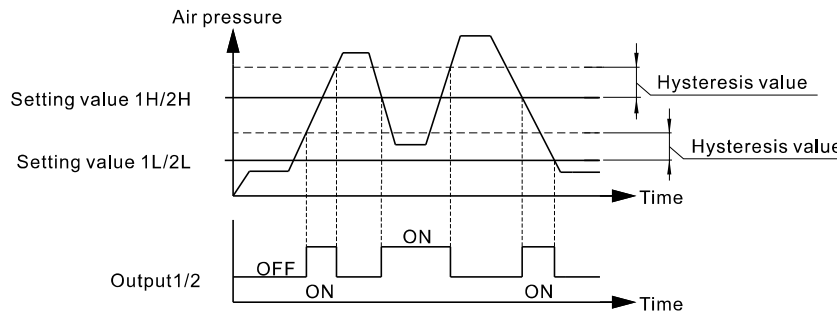

4. Suction check mode: Generally used for suction check detection applications. After the zero-shift signal is triggered, the zero-shift is completed after the TS time.

- TS: Zero-shift delay time.
- 1P: "Pressure" setting value of output 1 before zero-shift (or without zero-shift).
- 1P': Output 1 after zero-shift. Relative to the reference value of the suction starting point pressure (zero offset point).
- 2P: Pressure setting of output 2.

◇Output 1: Suction pressure detection,

In (N.O.) mode, the output 1 is ON when the measured pressure value is less than the setting value 1P (1P');

Without zero-shift input, output 1 ON/OFF judgment based on 1P, which is the suction pressure setting value relative to atmospheric pressure.

With a zero-shift input, output 1 ON/OFF judgment based on 1P', which is the reference setting value with relative to the zero-shift point.

◇Output 2: Vacuum plate break detection. In (N.O.) mode, output 2 turns ON when the air pressure is greater than the setting value 2P.

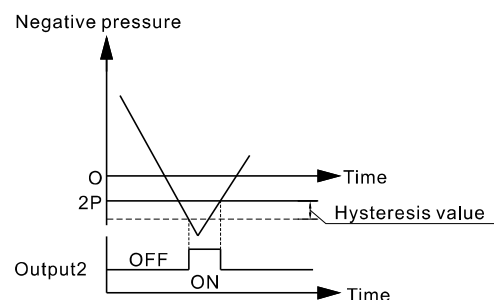
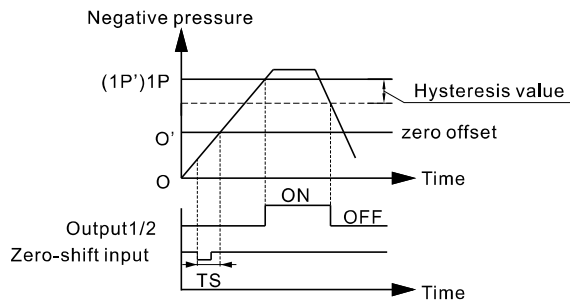

DPH Series digital display pressure sensor(Analog output)

5. Leakage Mode: Generally used for leak detection applications.

The zero-shift is completed after the zero-shift signal is triggered

- ◇ 1H: Output 1 upper limit setting value; 1L: Output 1 lower limit setting value.
- ◇ 2P(2P'): Output 2's "Leak" setting (Negative value).
- ◆ Output 1: Fill pressure detection. In the normally mode, output 1 is ON when the pressure is between 1H and 1L
- ◆ Output 2: Leakage detection. when only the zero-shift input, it will make output 2 ON/OFF judgment; In the normal mode, Output 2 is ON when the leakage is greater than the setting value 2P (2P').

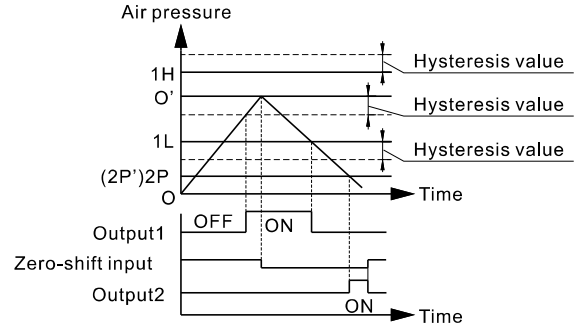

6. Analog output

6.1) Analog Voltage Output (1-5V)

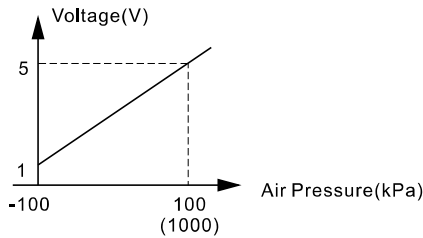

◆ In the analog voltage output mode, the orange line should pay attention to the following wiring:

1. Don't directly connect 0V or any bias voltage under no load to avoid internal circuit damage.
2. The minimum load impedance needs to be >1kΩ (Don't float) to avoid distortion of the output voltage.

6.2) Analog Current Output (4-20mA)

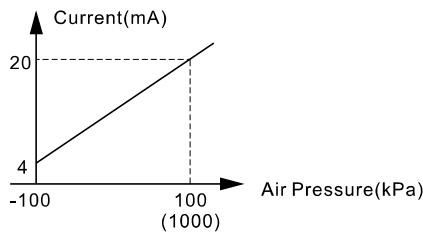

◆ In the analog current output mode, the orange line should pay attention to the following wiring:

1. Don't directly connect 0V or any bias voltage under no load to avoid internal circuit damage.
2. The range of load impedance is 50Ω to 260Ω. (Don't float) to avoid distortion of the output current.

7. Key lock Function

Lock: Press and the SET button simultaneously. Release it when the display turns to "LCK on".

Unlock: Press and the SET button simultaneously. Release it when the display turns to "LCK OFF".

Press any button will display "LCK" in lock on mode.

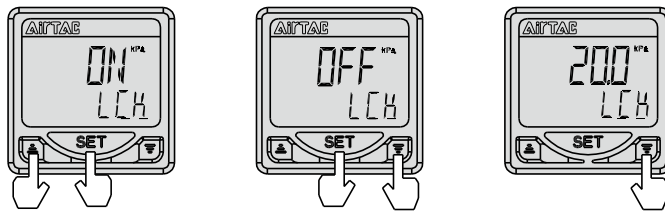

8. Zero-Clear Function

Press and simultaneously to reset the display value to zero.

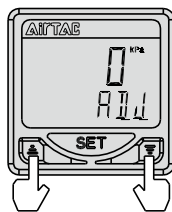

Press and simultaneously.

Dimensions/Assembly Instruction

Panel mount adapter + Front protective cover

Order the Install accessories (Ordering code: F-DPSEB)

Applicable panel thickness(T): 1~5mm

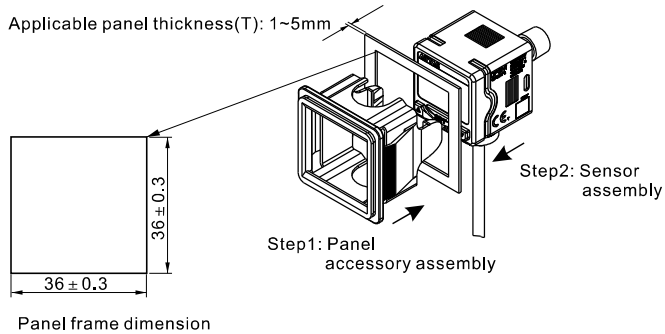

Bracket

Order the Install accessories (Ordering code: F-DPSLB)

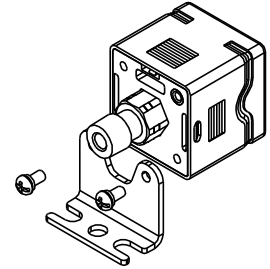
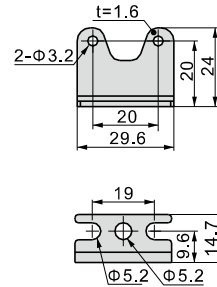

Notes

1. Do not drop, knock or apply excessive impact while handling. Otherwise could cause damage and a malfunction.
2. The tensile strength of the cord is 60N. Applying a greater pulling force on it can cause a malfunction.
3. Do not exceed the screw-in torque of 7N.m when installing piping. Exceeding this value may cause malfunctioning of the sensor.
4. Do not use it with corrosive and/or flammable gases or liquids.
5. Please use it within rated pressure range.
6. Turn off the power before connecting the wires.
7. Don't use in an environment with spattering liquid of oil or solvent.
8. Separate power lines from high voltage lines, avoiding wiring in the same conduit with these lines.