

# Small Bore Hydraulic Cylinder

## *CHN Series*

**CHQ**

CHK

**CHN**

CHM

CHS

CH2

**CHA**

Related  
Products

D-

### *CHN Series*

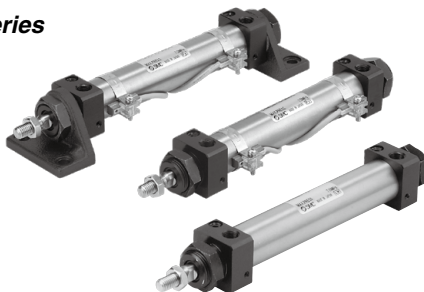

Nominal pressure: **7 MPa**

Bore size (mm): 20, 25, 32, 40

Stainless Steel Tube

# Small Bore Hydraulic Cylinder for 7 MPa

## CHN Series

ø20, ø25, ø32, ø40

### Equipped with cushion mechanism

- A cushion seal system mechanism is now a standard feature.
- Cushion valves are enhanced with a non-slip retaining mechanism.
- The cushion valve is a discreet type valve that does not protrude from the cover face.

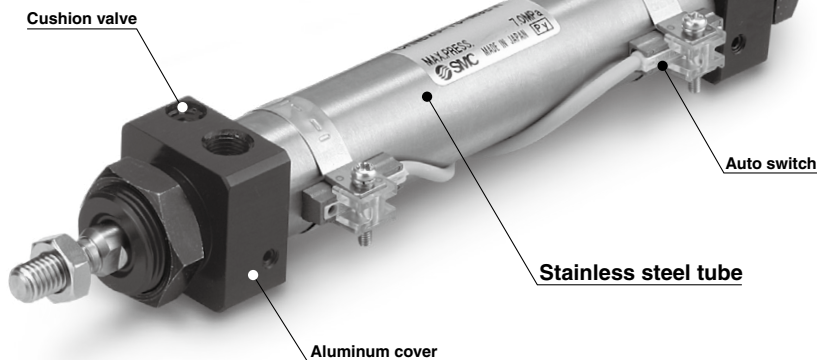
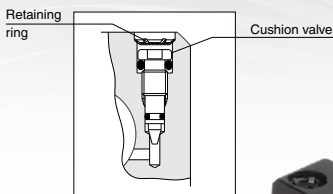

### Reduced cross sectional area

When compared to the same size tie-rod cylinder, the cross sectional area of our CHN series cylinder projects less than 45%, thereby attaining better space savings.

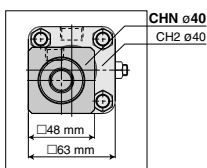

### Lightweight

Using aluminum alloy for both the rod cover and head cover reduces overall weight.

Model	Weight (kg)
CHNB20-100	0.51
CHNB25-100	0.63
CHNB32-100	0.89
CHNB40-100	1.51

Basic type with a 100 mm stroke

### Built-in magnet

All cylinders come with a built-in magnet as a standard feature. This makes possible the mounting of an auto switch for piston position sensing even after the cylinder has been installed.

### Series Variations

Series	Nominal pressure	Bore size (mm)	Mounting bracket	Auto Switches
CHN	7.0 MPa	20	Basic type Axial foot type Rod flange type Head flange type Single clevis type	Band mounting type Reed type Solid state type
		25		
		32		
		40		

# Hydraulic Cylinder

# CHN Series

7 MPa  
 ø20, ø25, ø32, ø40

## How to Order

CHN **L** **25** - **100** - **M9BW** **□** - **C**

### Mounting type

<b>B</b>	Basic type
<b>L</b>	Axial foot type
<b>F</b>	Rod flange type
<b>G</b>	Head flange type
<b>C</b>	Single clevis type

### Bore size

<b>20</b>	20 mm
<b>25</b>	25 mm
<b>32</b>	32 mm
<b>40</b>	40 mm

### Auto switch mounting bracket<sup>(Note)</sup>

Note) This symbol is indicated when the D-A9□ or M9□ type auto switch is specified.  
 This mounting bracket does not apply to other auto switches (D-C7□ and H7□, etc.)  
 Applicable to ø20 only.

### Number of auto switches

<b>Nil</b>	2 pcs.
<b>S</b>	1 pc.
<b>n</b>	*n* pcs.

### Auto switch type

<b>Nil</b>	Without auto switch (built-in magnet)
------------	---------------------------------------

\* Select applicable auto switches from the table below.

### Cylinder stroke (mm)

Refer to the standard stroke table on page 298.

## Applicable Auto Switches/Refer to pages 431 to 490 for further details on each auto switch.

Type	Special function	Electrical entry	Indicator light	Wiring (output)	Load voltage		Auto switch model		Lead wire length (m)					Pre-wired connector	Applicable load								
					DC	AC	Perpendicular	In-line	0.5 (Nil)	1 (M)	3 (L)	5 (Z)	None (N)										
																24 V		12 V		5 V			
Solid state auto switch	—	Grommet	No	3-wire (NPN)	5 V, 12 V	—	M9NV	M9N	●	—	●	○	—	○	IC circuit	Relay PLC							
				3-wire (PNP)			M9PV	M9P	●	—	○	—	○										
		Connector	Yes	2-wire	12 V	M9BV	M9B	●	—	●	○	—	○	—									
				Terminal conduit	3-wire (NPN)	5 V, 12 V	—	H7C	●	—	●	●	—	○	—								
	Diagnostic indication (2-color indicator)	Grommet	Yes	No	2-wire	12 V	—	G39	—	—	—	—	—	—	IC circuit								
					3-wire (NPN)	5 V, 12 V	—	K39	—	—	—	—	—	—	—								
					3-wire (PNP)	5 V, 12 V	M9NWV	M9NW	●	●	●	○	—	○	—								
					2-wire	12 V	M9PWV	M9PW	●	●	●	○	—	○	IC circuit								
					3-wire (NPN)	5 V, 12 V	M9BWB	M9BW	●	●	●	○	—	○	—								
					3-wire (PNP)	12 V	M9NAV <sup>*1</sup>	M9NA <sup>*1</sup>	○	○	●	○	—	○	IC circuit								
Water resistant (2-color indicator)	Grommet	Yes	No	2-wire	12 V	—	M9PAV <sup>*1</sup>	M9PA <sup>*1</sup>	○	○	●	○	—	○	—								
				3-wire (PNP)	12 V	—	M9BAV <sup>*1</sup>	M9BA <sup>*1</sup>	○	○	●	○	—	○	—								
				4-wire	5 V, 12 V	—	H7NF	●	—	●	—	○	○	IC circuit									
				4-wire (NPN)	5 V, 12 V	—	A96V	A96	●	—	●	—	○	○	IC circuit								
Reed auto switch	—	Grommet	Yes	No	2-wire	24 V	12 V	—	5 V	A96V	A96	●	—	●	—	○	○	IC circuit	Relay PLC				
										100 V	A93V <sup>*2</sup>	A93	●	●	●	●	—			—	—		
										100 V or less	A90V	A90	●	—	●	—	—			—	—		
										100 V, 200 V	—	B54	●	—	●	—	—			—	—		
										200 V or less	—	B64	●	—	●	—	—			—	—		
		Connector	No	Yes	No	2-wire	24 V	12 V	—	—	—	—	C73C	●	—	●	●	—		—	IC circuit		
												—	C80C	●	—	●	●	—		—			
												—	A33	—	—	—	—	●		—		—	
												100 V,	—	A34	—	—	—	—		●		—	—
												200 V	—	A44	—	—	—	—		●		—	—
Diagnostic indication (2-color indicator)	Grommet	Yes	No	2-wire	24 V	12 V	—	—	—	B59W	●	—	●	—	—	—	—						

\*1 Water resistant type auto switches can be mounted on the above models, but in such case SMC cannot guarantee water resistance. --(Applicable to ø20 only.)

Consult with SMC regarding water resistant types with the above model numbers.

\*2 1 m type lead wire is only applicable to D-A93.

\* Lead wire length symbols: 0.5 m ..... Nil (Example) M9NW  
 1 m ..... M (Example) M9NWM  
 3 m ..... L (Example) M9NWL  
 5 m ..... Z (Example) M9NWZ  
 None ..... N (Example) H7CN

\* Solid state auto switches marked "○" are produced upon receipt of order.

\* You do not need to specify "N" (i.e., without lead wire) for D-A3□, D-A44, D-G39, and D-K39. This is the only standard specification automatically available for these models.

\* D-A9□V, M9□V, M9□WV, and M9□A(V) models cannot be mounted on ø25 to ø40.

\* Since there are applicable auto switches other than listed, refer to page 310 for details.

\* For details about auto switches with pre-wired connector, refer to pages 474 and 475.

\* D-A9□, M9□, and M9□W type auto switches are shipped with the hydraulic cylinder (but not assembled). (However, they are auto switch mounting brackets are shipped with the mounting brackets mounted already).

# CHN Series



## Specifications

Bore size (mm)	20	25	32	40
<b>Action</b>	Double acting/Single rod			
<b>Fluid</b>	Hydraulic fluid			
<b>Nominal pressure</b>	7 MPa			
<b>Proof pressure</b>	10.5 MPa			
<b>Maximum allowable pressure</b>	9 MPa			
<b>Minimum operating pressure</b>	0.3 MPa			
<b>Ambient and fluid temperature</b>	Without auto switch: -10° to 80°C			
	With auto switch: -10° to 60°C			
<b>Piston speed</b>	8 to 300 mm/s			
<b>Cushion</b>	Cushion seal			
<b>Stroke length tolerance</b>	to 250 mm $\begin{matrix} +1.0 \\ 0 \end{matrix}$			
	251 to 800 mm $\begin{matrix} +1.4 \\ 0 \end{matrix}$			
<b>Mounting type</b>	Basic type, Axial foot type Head flange type, Rod flange type Single clevis type			

Note) Refer to page 214 for definitions of terms related to pressure.

## Accessories

Mounting type		Basic	Axial foot	Head flange	Rod flange	Single clevis
Standard	Mounting nut	● (2 pcs.)	● (2 pcs.)	● (1 pc.)	● (1 pc.)	—
	Rod end nut	●	●	●	●	●

## Option

I-type single knuckle joint Y-type double knuckle joint Bracket for clevis type Knuckle pin Bracket pin	Refer to page 307
---	-------------------

## Hydraulic Fluid Compatibility

Hydraulic fluid	Compatibility
Standard mineral hydraulic fluid	Compatible
W/O hydraulic fluids	Compatible
O/W hydraulic fluids	Compatible
Water/Glycol hydraulic fluids	*
Phosphate hydraulic fluids	Not compatible

\* Consult with SMC.

## Standard Strokes: Refer to page 309 for minimum strokes for auto switch mounting.

Bore size (mm)	Standard strokes (mm)	Long stroke
20	25 to 300	800
25	25 to 400	
32	25 to 500	
40		

\* Standard strokes above have a minimal delivery time.  
Consult with SMC for the manufacture of strokes other than the above.

## Mounting Brackets: Part Nos.

Bore size (mm)	20	25	32	40
Axial foot *	CHN-L020	CHN-L025	CHN-L032	CHN-L040
Flange	CHN-F020	CHN-F025	CHN-F032	CHN-F040

\* When ordering the axial foot type, order 2 pieces for each cylinder.

## Theoretical Output

Bore size (mm)	Rod size (mm)	Operating direction	Piston area (mm <sup>2</sup> )	Operating pressure (MPa)			
				1	3	5	7
20	10	OUT	314	314	942	1570	2198
		IN	235	235	705	1175	1645
25	12	OUT	490	490	1470	2450	3430
		IN	377	377	1131	1885	2639
32	16	OUT	804	804	2412	4020	5628
		IN	603	603	1809	3015	4221
40	18	OUT	1256	1256	3768	6280	8792
		IN	1002	1002	3006	5010	7014

Theoretical output (N) = Pressure (MPa) x Piston area (mm<sup>2</sup>)

## Weight

		Unit: kg			
Bore size (mm)		20	25	32	40
Basic Weight	Basic type	0.27	0.37	0.53	1.05
	Axial foot type	0.51	0.63	0.91	1.59
	Flange type	0.36	0.54	0.72	1.26
	Clevis type	0.25	0.45	0.67	1.00
	Additional weight per 50 mm	0.12	0.13	0.18	0.23

- Calculation method (Example) **CHNL20-100** (Foot type, ø20, 100 mm stroke)
- Basic weight ..... 0.51 kg
- Additional weight ... 0.12/50 mm
- Cylinder stroke ..... 100 mm
- 0.51 + 0.12/50 x 100 = 0.75 kg

### Specific Product Precautions

**Be sure to read this before handling the products.**  
**Refer to back page 50 for Safety Instructions and pages 214 to 221 for Hydraulic Cylinder and Auto Switch Precautions.**

### Caution

When operating a cylinder for the first time, make sure to release the air at low pressure. When the air release is complete, operate the cylinder at reduced pressure, gradually increasing it to the normal operating pressure. However, the piston speed at this time should be adjusted to the minimum speed.

### Mounting

### Caution

1. When mounting with bracket mounting nuts, tighten them using the tightening torques in the table below as a guide.

Bore size (mm)	Mounting nut thread	Mounting nut width across flats (mm)	Tightening torque (N-m)
20	M22 x 1.5	26	45
25	M24 x 1.5	32	60
32	M30 x 1.5	38	85
40	M33 x 1.5	41	110

2. When mounted with one side attached and one side unattached (basic type and flange type) and operating at high speed, bending moment acts on the cylinder due to oscillation at the stroke end, which may cause cylinder damage. In this case, install brackets to suppress the oscillation of the cylinder body, or reduce the piston speed enough so that the cylinder body does not oscillate at the stroke end.

CHQ

CHK

CHN

CHM

CHS

CHZ

CHA

Related Products

D-

# CHN Series

## Construction

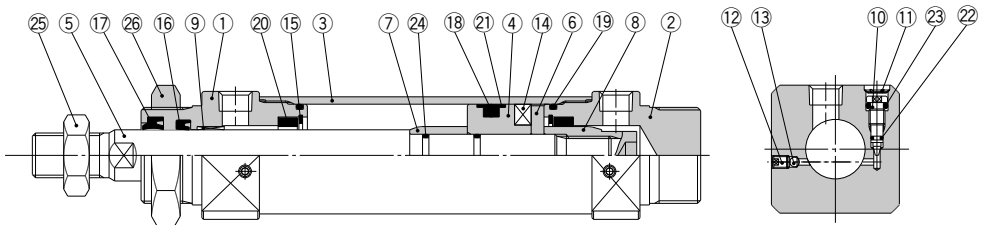

### Parts List

No.	Description	Material	Note
1	Rod cover	Aluminum alloy	Black anodized
2	Head cover	Aluminum alloy	Black anodized
3	Cylinder tube	Stainless steel	
4	Piston	Stainless steel	
5	Piston rod	ø20, 25: Stainless steel ø32, 40: Carbon steel	Hard chromium electro plating
6	Magnet plate	Stainless steel	
7	Cushion ring A	Carbon steel	
8	Cushion ring B	Carbon steel	
9	Bushing	Lead bronze	
10	Cushion valve	Carbon steel	
11	Retaining ring	Spring steel	
12	Air release valve	Alloy steel	
13	Check ball	Bearing steel	

### Replacement Parts: Seal Kit

Bore size (mm)	Seal kit no.	Content
20	CHN20-PS	Nos. 16 to 21 from the chart
25	CHN25-PS	
32	CHN32-PS	
40	CHN40-PS	

\* Seal kit consists of items 16 to 20 and 22 and can be ordered by using the seal kit number for each bore size.

### Parts List

No.	Description	Material	Note
14	Magnet	—	
15	Retaining ring	Spring steel	
16	Rod seal	NBR	
17	Scraper	NBR	
18	Piston seal	NBR	
19	Tube gasket	NBR	
20	Cushion seal	—	
21	Back-up ring	Resin	
22	Cushion valve seal A	NBR	
23	Cushion valve seal B	NBR	
24	Piston gasket	NBR	
25	Rod end nut	Carbon steel	
26	Mounting nut	Carbon steel	

**Dimensions**

**Basic type: CHNB**

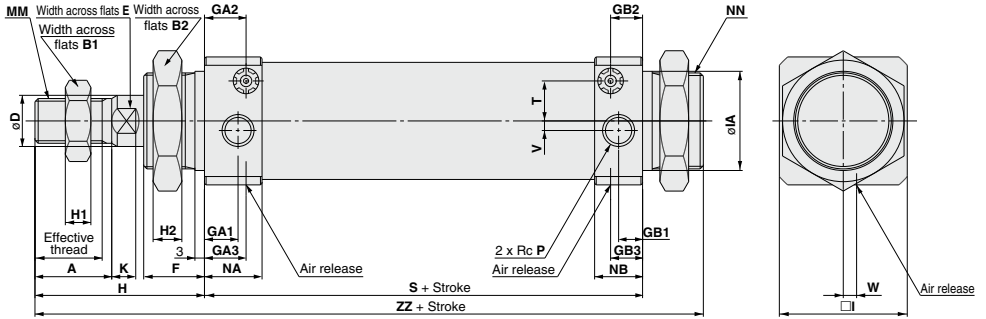

- CHQ**
- CHK
- CHN**
- CHM
- CHS
- CH2
- CHA**
- Related Products
- D-

(mm)

Bore size (mm)	Stroke range (mm)	Effective thread length (mm)	A	B1	B2	D	E	F	GA1	GA2	GA3	GB1	GB2	GB3	H	H1	H2	I
20	25 to 300	15.5	18	13	26	10	8	16	10	12	12	8	10	10	41	5	8	31
25	25 to 400	19.5	22	17	32	12	10	16	10	12	12	8	10	10	46	6	8	34
32	25 to 500	21	24	22	38	16	14	19	11	13	13	8	10	10	53	8	9	40
40	25 to 500	21	24	24	41	18	16	21	12	17	17	11	16	16	54	10	11	48

(mm)

Bore size (mm)	IA	K	MM	NA	NB	NN	P	S	T	V	W	ZZ
20	23f8 <sup>-0.020</sup> <sub>-0.053</sub>	5	M8 x 1.25	17	15	M22 x 1.5	1/8	81	9.5	4.5	6.5	138
25	25f8 <sup>-0.020</sup> <sub>-0.053</sub>	5.5	M10 x 1.25	17	15	M24 x 1.5	1/8	81	11	3.5	5.5	143
32	31f8 <sup>-0.025</sup> <sub>-0.064</sub>	7.5	M14 x 1.5	18	15	M30 x 1.5	1/8	87	13	3	4	159
40	34f8 <sup>-0.025</sup> <sub>-0.064</sub>	7.5	M16 x 1.5	22	21	M33 x 2	1/4	108	16	5	0	183

# CHN Series

## Dimensions

### Axial foot type: CHNL

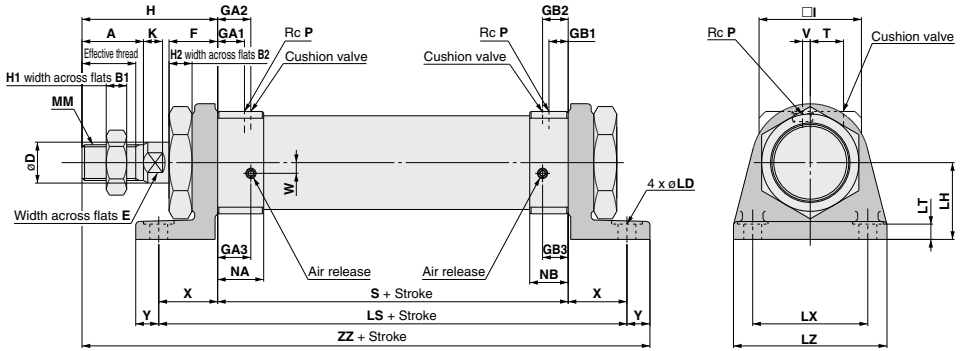

Bore size (mm)	Stroke range (mm)	Effective thread length (mm)	A	B1	B2	D	E	F	GA1	GA2	GA3	GB1	GB2	GB3	H	H1	H2	I	K
20	25 to 300	15.5	18	13	26	10	8	16	10	12	12	8	10	10	41	5	8	31	5
25	25 to 400	19.5	22	17	32	12	10	16	10	12	12	8	10	10	46	6	8	34	5.5
32	25 to 500	21	24	22	38	16	14	19	11	13	13	8	10	10	53	8	9	40	7.5
40	25 to 500	21	24	24	41	18	16	21	12	17	17	11	16	16	54	10	11	48	7.5

Bore size (mm)	LD	LH	LS	LT	LX	LZ	MM	NA	NB	P	S	T	V	W	X	Y	ZZ
20	7	25	121	5.5	40	55	M8 x 1.25	17	15	1/8	81	9.5	4.5	6.5	20	9	151
25	7	28	121	5.5	40	55	M10 x 1.25	17	15	1/8	81	11	3.5	5.5	20	9	156
32	7	30	133	6	45	60	M14 x 1.5	18	15	1/8	87	13	3	4	23	9	172
40	9	35	158	6	55	75	M16 x 1.5	22	21	1/4	108	16	5	0	25	11	198



Rod flange type: **CHNF**

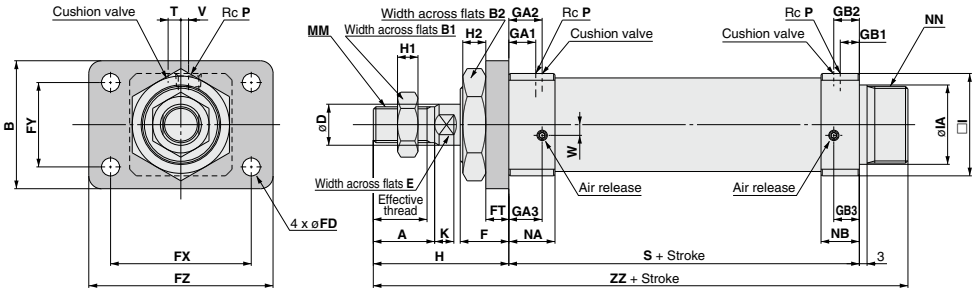

- CHK**
- CHK**
- CHN**
- CHM**
- CHS**
- CH2**
- CHA**
- Related Products
- D-**

Bore size (mm)	Stroke range (mm)	Effective thread length (mm)	A	B	B1	B2	D	E	F	FD	FT	FX	FY	FZ	GA1	GA2	GA3	GB1	GB2
20	25 to 300	15.5	18	38	13	26	10	8	16	7	6	51	21	68	10	12	12	8	10
25	25 to 400	19.5	22	44	17	32	12	10	16	7	9	53	27	70	10	12	12	8	10
32	25 to 500	21	24	50	22	38	16	14	19	7	9	55	33	72	11	13	13	8	10
40	25 to 500	21	24	60	24	41	18	16	21	9	9	66	36	84	12	17	17	11	16

Bore size (mm)	GB3	H	H1	H2	I	IA	K	MM	NA	NB	NN	P	S	T	V	W	ZZ
20	10	41	5	8	31	23f8 <sup>+0.020</sup> <sub>-0.053</sub>	5	M8 x 1.25	17	15	M22 x 1.5	1/8	81	9.5	4.5	6.5	138
25	10	46	6	8	34	25f8 <sup>+0.020</sup> <sub>-0.053</sub>	5.5	M10 x 1.25	17	15	M24 x 1.5	1/8	81	11	3.5	5.5	143
32	10	53	8	9	40	31f8 <sup>+0.025</sup> <sub>-0.064</sub>	7.5	M14 x 1.5	18	15	M30 x 1.5	1/8	87	13	3	4	159
40	16	54	10	11	48	34f8 <sup>+0.025</sup> <sub>-0.064</sub>	7.5	M16 x 1.5	22	21	M33 x 2	1/4	108	16	5	0	183

# CHN Series

## Dimensions

### Head flange type: CHNG

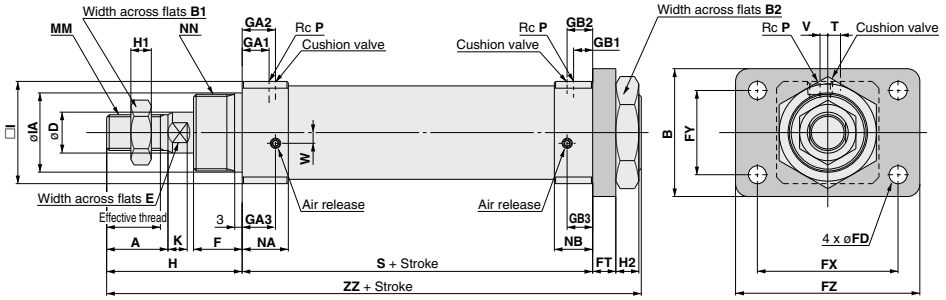

Bore size (mm)	Stroke range (mm)	Effective thread length (mm)	A	B	B1	B2	D	E	F	FD	FT	FX	FY	FZ	GA1	GA2	GA3	GB1	GB2
20	25 to 300	15.5	18	38	13	26	10	8	16	7	6	51	21	68	10	12	12	8	10
25	25 to 400	19.5	22	44	17	32	12	10	16	7	9	53	27	70	10	12	12	8	10
32	25 to 500	21	24	50	22	38	16	14	19	7	9	55	33	72	11	13	13	8	10
40	25 to 500	21	24	60	24	41	18	16	21	9	9	66	36	84	12	17	17	11	16

Bore size (mm)	GB3	H	H1	H2	I	IA	K	MM	NA	NB	NN	P	S	T	V	W	ZZ
20	10	41	5	8	31	23 <sup>+0.020</sup> <sub>-0.033</sub>	5	M8 x 1.25	17	15	M22 x 1.5	1/8	81	9.5	4.5	6.5	138
25	10	46	6	8	34	25 <sup>+0.020</sup> <sub>-0.033</sub>	5.5	M10 x 1.25	17	15	M24 x 1.5	1/8	81	11	3.5	5.5	143
32	10	53	8	9	40	31 <sup>+0.025</sup> <sub>-0.064</sub>	7.5	M14 x 1.5	18	15	M30 x 1.5	1/8	87	13	3	4	159
40	16	54	10	11	48	34 <sup>+0.025</sup> <sub>-0.064</sub>	7.5	M16 x 1.5	22	21	M33 x 2	1/4	108	16	5	0	183

Single clevis type: **CHNC**

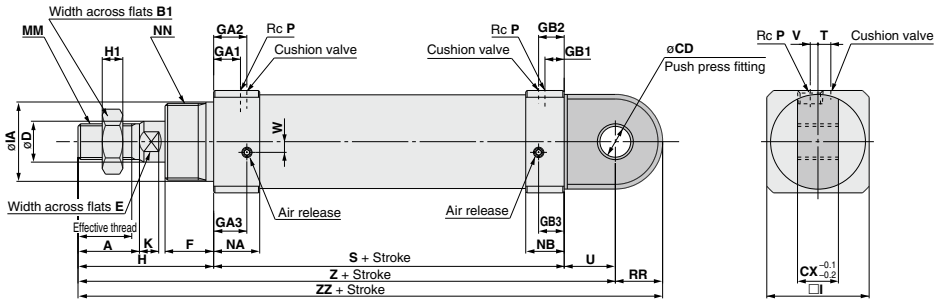

- CHQ**
- CHK
- CHN**
- CHM
- CHS
- CHZ
- CHA**
- Related Products
- D-

Bore size (mm)	Stroke range (mm)	Effective thread length (mm)	A	B1	CD	CX	D	E	F	GA1	GA2	GA3	GB1	GB2	GB3	H	H1	I
20	25 to 300	15.5	18	13	10 <sup>+0.109</sup> / <sub>0</sub>	16	10	8	16	10	12	12	8	10	10	41	5	31
25	25 to 400	19.5	22	17	10 <sup>+0.109</sup> / <sub>0</sub>	16	12	10	16	10	12	12	8	10	10	46	6	34
32	25 to 500	21	24	22	12 <sup>+0.109</sup> / <sub>0</sub>	16	16	14	19	11	13	13	8	10	10	53	8	40
40	25 to 500	21	24	24	16 <sup>+0.034</sup> / <sub>+0.015</sub>	24	18	16	21	12	17	17	11	16	16	54	10	48

Bore size (mm)	IA	K	MM	NA	NB	NN	P	RR	S	T	U	V	W	Z	ZZ
20	23f8 <sup>-0.020</sup> / <sub>-0.053</sub>	5	M8 x 1.25	17	15	M22 x 1.5	1/8	13.5	81	9.5	14	4.5	6.5	136	149.5
25	25f8 <sup>-0.020</sup> / <sub>-0.053</sub>	5.5	M10 x 1.25	17	15	M24 x 1.5	1/8	14.5	81	11	15	3.5	5.5	142	156.5
32	31f8 <sup>-0.025</sup> / <sub>-0.064</sub>	7.5	M14 x 1.5	18	15	M30 x 1.5	1/8	18.5	87	13	20	3	4	160	178.5
40	34f8 <sup>-0.025</sup> / <sub>-0.064</sub>	7.5	M16 x 1.5	22	21	M33 x 2	1/4	22.5	108	16	20	5	0	182	204.5

# CHN Series

## Accessories (Standard)

### Rod end nut

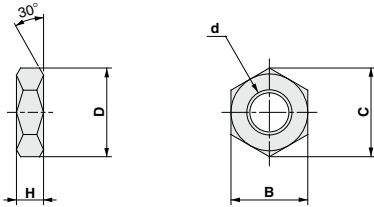

Material: Carbon steel

Part no.	Applicable bore size (mm)	d	H	B	C	D
<b>NT-02</b>	20	M8 x 1.25	5	13	15.0	12.5
<b>NT-03</b>	25	M10 x 1.25	6	17	19.6	16.5
<b>NT-04</b>	32	M14 x 1.5	8	22	25.4	21.0
<b>AC-NI-50</b>	40	M16 x 1.5	10	24	27.7	23

### Mounting nut

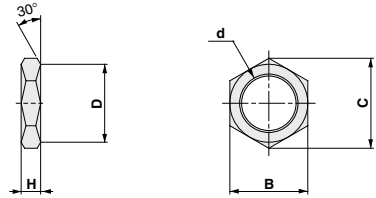

Material: Carbon steel

Part no.	Applicable bore size (mm)	d	H	B	C	D
<b>SO-02</b>	20	M22 x 1.5	8	26	30	26
<b>SO-03</b>	25	M24 x 1.5	8	32	36.9	32
<b>SO-04</b>	32	M30 x 1.5	9	38	43.9	38
<b>SO-05</b>	40	M33 x 2.0	11	41	47.3	41

## Accessory Brackets (Optional)

### I-type single knuckle joint

ø20: I-02  
ø25: I-03

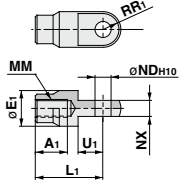

ø32: I-04  
ø40: IHN-04

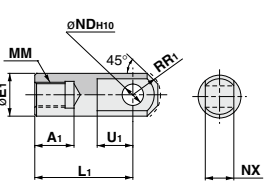

Material: Rolled steel plate

Material: Rolled steel plate

Part no.	Applicable bore size (mm)	A1	E1	L1	MM	R1	U1	ND <sup>H10</sup>	
								Size	Tolerance
I-020B	20	16	20	36	M8 x 1.25	10	14	9 <sup>+0.058</sup> <sub>0</sub>	9 <sup>-0.1</sup> <sub>-0.2</sub>
I-032B	25	18	20	38	M10 x 1.25	10	14	9 <sup>+0.058</sup> <sub>0</sub>	9 <sup>-0.1</sup> <sub>-0.2</sub>
I-04A	32	22	24	55	M14 x 1.5	15.5	20	12 <sup>+0.070</sup> <sub>0</sub>	16 <sup>-0.1</sup> <sub>-0.3</sub>
IHN-04	40	22	24	55	M16 x 1.5	15.5	20	15 <sup>+0.070</sup> <sub>0</sub>	16 <sup>-0.1</sup> <sub>-0.3</sub>

### Y-type double knuckle joint

ø20: Y-02  
ø25: Y-03

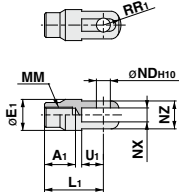

ø32: Y-04C  
ø40: YHN-04

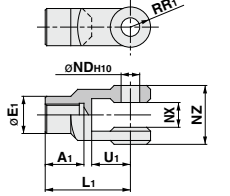

Material: Rolled steel plate

Material: Cast iron

Part no.	Applicable bore size (mm)	A1	E1	L1	MM	R1	U1	ND <sup>H10</sup>	
								Size	Tolerance
Y-020B	20	16	20	36	M8 x 1.25	12	14	9 <sup>+0.058</sup> <sub>0</sub>	9 <sup>+0.2</sup> <sub>+0.1</sub>
Y-032B	25	18	20	38	M10 x 1.25	12	14	9 <sup>+0.058</sup> <sub>0</sub>	9 <sup>+0.2</sup> <sub>+0.1</sub>
Y-04D	32	22	24	55	M14 x 1.5	13	25	12 <sup>+0.070</sup> <sub>0</sub>	16 <sup>+0.3</sup> <sub>+0.1</sub>
YHN-04	40	22	24	55	M16 x 1.5	13	25	15 <sup>+0.070</sup> <sub>0</sub>	16 <sup>+0.3</sup> <sub>+0.1</sub>

Part no.	NZ	Note
Y-03	18	With CDP-1 (with retaining ring)
Y-04C	38	With CDP-3 (with cotter pin)
YHN-04	38	With CDPN-4 (with cotter pin)

### Knuckle pin

ø20, ø25  
Part no.: CDP-1  
Material: Carbon steel

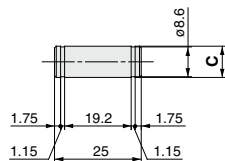

Retaining ring: C type 9 for shaft

ø32, ø40  
Part no.: CDP-3 CDPN-4  
Material: Carbon steel

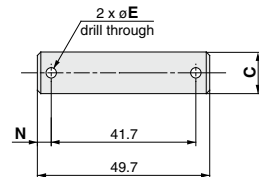

Cotter pin: ø3 x 18 ℓ

### Bracket for clevis type

\* Order bracket pin separately.

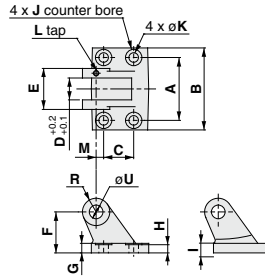

Material: Cast iron

Part no.	Applicable bore size (mm)	A	B	C	D	U (H8)		E	F	G	H	I
						Size	Tolerance					
AD-FI-20	20	46	60	22	16	10	+0.027 0	30	28	6.5	5.5	10
AD-FI-25	25	46	60	22	16	10	+0.027 0	30	30	6.5	5.5	10
AD-FI-32	32	56	80	30	16	12	+0.027 0	36	40	10	9	13
AD-CHN-40	40	64	88	30	24	16	+0.027 0	44	43	10	9	13

Part no.	J	K	L	M	R	Note
AD-FI-20	12	7	M4	5.5	10	M4 set screws (once)
AD-FI-25	12	7	M4	5.5	10	M4 set screws (once)
AD-FI-32	12	7	M5	7	12	M5 set screws (once)
AD-CHN-40	16	9	M5	10	12	M5 set screws (once)

### Bracket pin

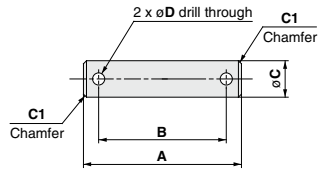

Material: Carbon steel

Part no.	Applicable bore size (mm)	A	B	C (F7)		D	Note
				Size	Tolerance		
AD-EI-20	20	45.5	35.5	10	-0.016 -0.034	3.2	with (2) cotter pins ø3.2 x 15 ℓ
AD-EI-25	25	45.5	35.5	10	-0.016 -0.034	3.2	with (2) cotter pins ø3.2 x 15 ℓ
AD-EI-32	32	52	42	12	-0.016 -0.034	4	with (2) cotter pins ø4 x 20 ℓ
AE-CHN-40	40	60	50	16	-0.016 -0.034	4	with (2) cotter pins ø4 x 20 ℓ

Part no.	Applicable bore size (mm)	C (ø9)	N	E	Note
CDP-1	20	9	—	—	with (2) retaining rings: C type 9
	25				
CDP-3	32	12	4	3	with (2) cotter pins ø3 x 18 ℓ
CDPN-4	40	15	5	3.2	with (2) cotter pins ø3.2 x 20 ℓ

# Auto Switch Mounting

Refer to pages 431 to 490 for detailed auto switch specifications.

## Auto Switches: Proper Mounting Positions and Mounting Heights for Stroke End Detection

**D-A9□V**

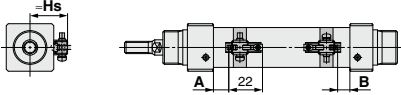

A and B are the dimensions from the end of the head cover/rod cover to the end of the auto switch.

**D-M9□V/M9□WV/M9□AV**

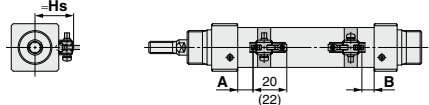

A and B are the dimensions from the end of the head cover/rod cover to the end of the auto switch.  
\* Dimensions inside ( ) are for D-M9□AV.

**D-A9□**

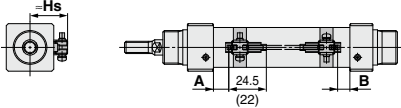

A and B are the dimensions from the end of the head cover/rod cover to the end of the auto switch.  
\* Dimensions inside ( ) are for D-M9□AV.

**D-M9□/M9□W/M9□A**

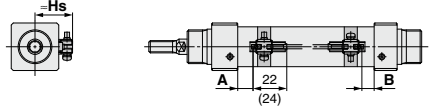

A and B are the dimensions from the end of the head cover/rod cover to the end of the auto switch.  
\* Dimensions inside ( ) are for D-M9□AV.

**D-C7□/C80**

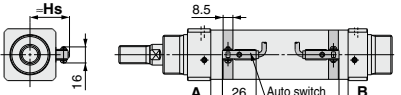

**D-H7□/H7□W/H7NF/H7BA**

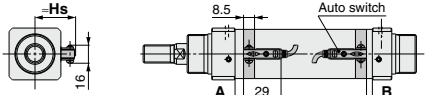

**D-C73C/C80C**

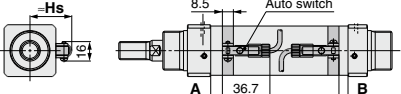

**D-H7C**

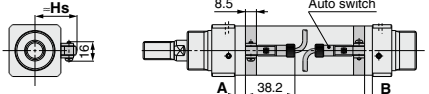

**D-B5□/B64/B59W**

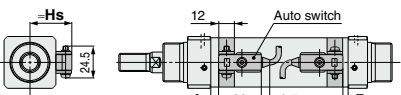

**D-G5□/K59/G5□W/K59W/G5BA/G59F/G5NT**

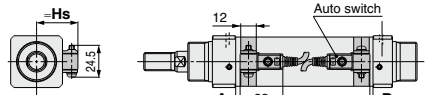

**D-A3□/G39/K39**

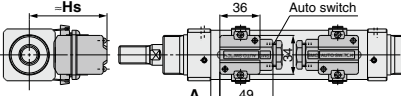

**D-A44**

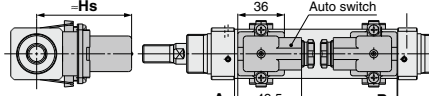

## Auto Switch Proper Mounting Positions

Bore size (mm)	Solid state auto switch								Reed auto switch									
	D-M9□(V) D-M9□W(V) D-M9□A(V)		D-H7□ D-H7□W/H7C D-H7NF/H7BA		D-G5□/K59 D-G5□W/K59W D-G59F/G5BA D-G5NT		D-G39/K39		D-A9□(V)		D-C7□/C80 D-C73C/C80C		D-B5□/B64		D-B59W		D-A3□/A44	
	A	B	A	B	A	B	A	B	A	B	A	B	A	B	A	B	A	B
20	23	14	18.5	9.5	15	6	13	4	19	10	19.5	10.5	13.5	4.5	16.5	7.5	13	4
25	23.5	13.5	19	9	15.5	5.5	13.5	3.5	19.5	9.5	20	10	14	4	17	7	13.5	3.5
32	25.5	16.5	21	12	17.5	8.5	15.5	6.5	21.5	12.5	22	13	16	7	19	10	15.5	6.5
40	31.5	21.5	27	17	23.5	13.5	21.5	11.5	27.5	17.5	28	18	22	12	25	15	21.5	11.5

Note) Adjust the auto switch after confirming the operating conditions in the actual setting.

## Auto Switch Mounting Heights

Bore size (mm)	D-M9□(V) D-M9□W(V) D-M9□A(V) D-A9□(V)		D-H7□/H7□W D-H7NF/H7BA D-C7□/C80		D-C73C/C80C		D-G5□/K59 D-G5□W/K59W D-G59F/G5BA D-G5NT/H7C D-B5□/B64 D-B59W		D-G39/K39 D-A3□		D-A44	
	Hs		Hs		Hs		Hs		Hs		Hs	
20	26		25.5		27		27.5		62		72	
25	28		27.5		29		29.5		64		74	
32	31.5		31		32.5		33		67.5		77.5	
40	35.5		35		36.5		37		71.5		81.5	

### Minimum Auto Switch Mounting Stroke

Auto switch model	(mm)				
	1 pc.	Number of auto switches mounted		n pcs.	
		2 pcs.			
		Different surfaces	Same surface	Different surfaces	Same surface
D-M9□	5	20	55	$20 + 35 \frac{(n-2)}{2}$ (n = 2, 4, 6...) <small>Note 3)</small>	$55 + 35 (n-2)$ (n = 2, 3, 4, 5...)
D-M9□W	10	20	55	$20 + 35 \frac{(n-2)}{2}$ (n = 2, 4, 6...) <small>Note 3)</small>	$55 + 35 (n-2)$ (n = 2, 3, 4, 5...)
D-M9□A	10	25	60	$25 + 35 \frac{(n-2)}{2}$ (n = 2, 4, 6...) <small>Note 3)</small>	$60 + 35 (n-2)$ (n = 2, 3, 4, 5...)
D-A9□	5	15	50	$15 + 35 \frac{(n-2)}{2}$ (n = 2, 4, 6...) <small>Note 3)</small>	$50 + 35 (n-2)$ (n = 2, 3, 4, 5...)
D-M9□V	5	20	35	$20 + 35 \frac{(n-2)}{2}$ (n = 2, 4, 6...) <small>Note 3)</small>	$35 + 35 (n-2)$ (n = 2, 3, 4, 5...)
D-A9□V	5	15	25	$15 + 35 \frac{(n-2)}{2}$ (n = 2, 4, 6...) <small>Note 3)</small>	$25 + 35 (n-2)$ (n = 2, 3, 4, 5...)
D-M9□WV D-M9□AV	10	20	35	$20 + 35 \frac{(n-2)}{2}$ (n = 2, 4, 6...) <small>Note 3)</small>	$35 + 35 (n-2)$ (n = 2, 3, 4, 5...)
D-H7□/H7□W D-H7NF/H7BA	10	15	60	$15 + 45 \frac{(n-2)}{2}$ (n = 2, 4, 6...) <small>Note 3)</small>	$60 + 45 (n-2)$ (n = 2, 3, 4, 5...)
D-C7□ D-C8□	10	15	50	$15 + 45 \frac{(n-2)}{2}$ (n = 2, 4, 6...) <small>Note 3)</small>	$50 + 45 (n-2)$ (n = 2, 3, 4, 5...)
D-H7C D-C73C D-C80C	10	15	65	$15 + 50 \frac{(n-2)}{2}$ (n = 2, 4, 6...) <small>Note 3)</small>	$65 + 50 (n-2)$ (n = 2, 3, 4, 5...)
D-G5□/K59 D-G5□W/K59W D-G59F/G5BA/G5NT D-B5□/B64	10	15	75	$15 + 50 \frac{(n-2)}{2}$ (n = 2, 4, 6...) <small>Note 3)</small>	$75 + 55 (n-2)$ (n = 2, 3, 4, 5...)
D-B59W	15	20	75	$20 + 50 \frac{(n-2)}{2}$ (n = 2, 4, 6...) <small>Note 3)</small>	$75 + 55 (n-2)$ (n = 2, 3, 4, 5...)
D-G39/K39 D-A3□/A44	10	35	100	$35 + 30 (n-2)$ (n = 2, 3, 4, 5...)	$100 + 100 (n-2)$ (n = 2, 3, 4, 5...)

Note 3) When "n" is an odd number, an even number that is one larger than this odd number is used for the calculation.

Note 1) Auto switch mounting

Auto switch model	Auto switches — 2 pcs.	
	Different surfaces	Same surface
	<p>Correct auto switch mounting position is 3.5 mm from the back face of the switch holder.</p>	<p>Mount auto switches offset (in circumferential direction of cylinder tube) so that auto switch units and lead wires do not run up against each other.</p>
D-M9□ D-M9□W	Less than 20 stroke <small>Note 2)</small>	Less than 55 stroke <small>Note 2)</small>
D-M9□A	Less than 25 stroke <small>Note 2)</small>	Less than 60 stroke <small>Note 2)</small>
D-A9□	—	Less than 50 stroke <small>Note 2)</small>

Note 2) Minimum stroke for auto switch mounting in types other than those mentioned in Note 1.

### Operating Range

Auto switch model	(mm)			
	Bore size			
	20	25	32	40
D-M9□(V) D-M9□W(V) D-M9□A(V)	4.5	4	4	4.5
D-H7□/H7C D-H7□W D-H7NF/H7BA	4.5	5	4.5	5
D-G5□/K59/G59F D-G5□W/K59W D-G5BA/G5NT	5.5	5	4.5	5

Auto switch model	(mm)			
	Bore size			
	20	25	32	40
D-G39/K39	9	8.5	10	10.5
D-A9□(V)	8	7.5	7	8
D-C7□/C80 D-C73C/C80C	10.5	9.5	8.5	10
D-B5□/B64	13.5	11.5	10	12
D-B59W	13.5	13	11.5	13.5
D-A3□/A44	11.5	10	9	10.5

\* Since this is a guideline including hysteresis, not meant to be guaranteed. (Assuming approximately ±30% dispersion.) There may be the case it will vary substantially depending on an ambient environment.

## Auto Switch Mounting Brackets: Part Nos.

Auto switch models	Bore size (mm)			
	φ20	φ25	φ32	φ40
D-A9□(V) D-M9□(V) D-M9□W(V)	Note 1) BMA3-020	BJ3-1 + BHN3-025	BJ3-1 + BHN3-032	BJ3-1 + BHN3-040
D-M9□A(V)	Note 2) BMA3-020S	—	—	—
D-H7□ D-H7□W D-H7NF D-H7BA D-C7□/C80 D-C73C/C80C	BMA2-020A	BHN3-025	BHN3-032	BHN3-040
D-G5□/G5□W D-G59F D-G5BA/G5NT D-B5□/B64 D-B59W	BA-01	BHN2-025	BGS1-032	BH2-040
D-G39/K39 D-A3□/A44	BD1-01M	BD1-02M	BHN1-032	BDS-04M

Note 1) Set part number which includes the auto switch mounting band (BMA2-020A) and the holder kit (BJ5-1/Switch bracket: Transparent).

Since the switch bracket (made from nylon) are affected in an environment where alcohol, chloroform, methylamines, hydrochloric acid or sulfuric acid is splashed over, so it cannot be used. Please consult SMC regarding other chemicals.

Note 2) Set part number which includes the auto switch mounting band, stainless steel screw and the holder kit (BJ4-1/Switch bracket: White).

Note 3) For the D-M9□A(V) type auto switch, do not install the switch bracket on the indicator light.

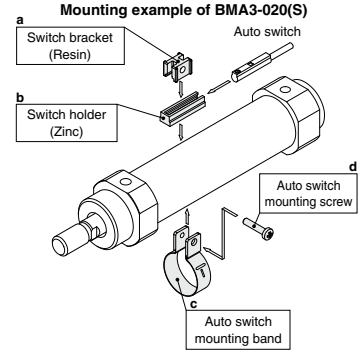

(1) BJ□-1 is a set of "a" and "b".

(2) BMA2-020A(S) is a set of "c" and "d".  
Band (c) is mounted so that the projected part is on the internal side (contact side with the tube).  
BJ4-1 (Switch bracket: White)  
BJ5-1 (Switch bracket: Transparent)

### [Stainless steel mounting screw kits]

The following stainless steel mounting screw kits are available for use depending on the operating environment. (Switch mounting bands are not included and should be ordered separately.)

BBA3: D-G5, K5, B5, B6

BBA4: D-C7, C8, H7

Note) Refer to the table below for details on BBA3, BBA4.

The above stainless steel screws are used when a cylinder is shipped with the D-H7BA or G5BA auto switches.

When only an auto switch is shipped independently, the BBA3 or BBA4 is attached.

### Stainless steel mounting screw kit details.

Part no.	Contents			Applicable auto switch mounting bracket part nos.	Applicable auto switches
	Description	size	pcs.		
BBA3	Auto switch mounting screw set	M4 x 0.7 x 22L	1	BA-01, BA-02, BA-32, BA-04, BA-05, BA-06, BA-08, BA-10	D-B5, B6 D-G5, K5
				BA2-020, BA2-025, BA2-032, BA2-040	
				BA5-050, BHN2-025, BSG1-032	
				BH2-040, BH2-050, BH2-080, BH2-100	
				BAF-32, BAF-04, BAF-05, BAF-06, BAF-08, BAF-10	
				BJ2-006, BJ2-010, BJ2-016	
BBA4		M3 x 0.5 x 14L	1	BM2-020A, BM2-025A, BM2-032A, BM2-040A	D-C7, C8 D-H7
				BMA2-020A, BMA2-025A, BMA2-032A, BMA2-040A, BMA2-050A, BMA2-063A	
				BHN3-025, BHN3-032, BHN3-040	

Besides the models listed in "How to Order," the following auto switches are applicable.

Refer to pages 431 to 490 for detailed auto switch specifications.

Auto switch type	Part no.	Electrical entry	Features
Solid state	D-H7A1, H7A2, H7B	Grommet (in-line)	—
	D-G59, G5P, K59		Diagnostic indication (2-color indicator)
	D-H7NW, H7PW, H7BW		Water resistant (2-color indicator)
	D-G59W, G5PW, K59W		With timer
	D-G5BA, H7BA		With diagnostic output (2-color indicator)
	D-G5NT D-G59F		—
Reed	D-C73, C76, B53	Grommet (in-line)	—
	D-C80		Without indicator light

\* Solid state auto switches are also available with pre-wired connector. Refer to pages 474 and 475 for details.

\* Normally closed (N.C. = b contact), solid state auto switches (D-F9G, F9H) are also available. For details, refer to page 443.



## How to Mount and Move the Auto Switch

### ⚠ Caution

1. Tighten the screw under the specified torque when mounting auto switch.
2. Set the auto switch mounting band perpendicularly to cylinder tube.

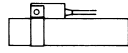

Mounting correctly

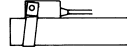

Mounting incorrectly

### <Applicable auto switch>

Solid state ..... **D-M9N, M9P, M9B, M9NV, M9PV, M9BV**  
**D-M9NW, M9PW, M9BW, M9NWW, M9PWW, M9BWW**  
**D-M9NA, M9PA, M9BA, M9NAV, M9PAV, M9BAV**  
 Reed ..... **D-A90, A93, A96, A90V, A93V, A96V**

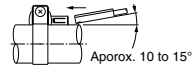
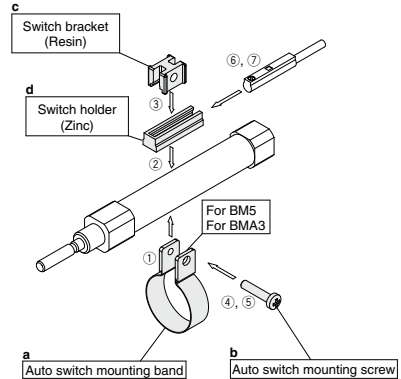

Figure 1. Switch insert angle

## How to Mount and Move the Auto Switch

### Mounting the Auto Switch

1. Mount the auto switch mounting band around the auto switch setting position on the cylinder tube.
2. Place the switch holder in the opening of the auto switch mounting band (1).
3. Make the concave part of the switch bracket faced downward and set the switch bracket on the switch holder (2).  
 Set the switch bracket so that both ends of the auto switch mounting band enter the portion between the ribs on both side surfaces of the switch bracket.  
 For the D-M9□A (V) type auto switch, do not install the switch bracket on the indicator light.
4. Pass the auto switch mounting screw (M3) supplied with the auto switch mounting band and engage it with the M3 female thread of the auto switch mounting band through the through-hole in the switch bracket.
5. Tighten the auto switch mounting screw with the specified tightening torque (0.6 to 0.7 N·m).
6. Insert the auto switch into the auto switch mounting groove of the switch holder (2).
7. After checking the detection position, tighten the set screw (M2.5) supplied with the auto switch to secure the auto switch.



### Tightening torque for the set screw (M2.5) supplied with the auto switch (N·m)

Auto switch model	Tightening torque
<b>D-M9□(V)</b>	0.05 to 0.15
<b>D-M9□(V)</b>	
<b>D-M9□A(V)</b>	
<b>D-A9□(V)</b>	0.1 to 0.2

When tightening the set screw supplied with the auto switch, use a watchmaker's screw driver with a handle diameter of 5 to 6 mm.

### Adjustment the Auto Switch Position

1. To make the fine adjustment, loosen the set screw (M2.5) supplied with the auto switch and slide the auto switch inside the auto switch mounting groove to adjust the position.
2. To move the auto switch setting position largely, loosen the screw (M3) that secures the auto switch mounting band and slide the auto switch together with the switch holder on the cylinder tube to adjust the position.

Note) When removing the screw connection part with the auto switch mounting screw after the auto switch mounting band has been assembled, be careful not to drop the switch bracket, switch holder, auto switch mounting screw, or auto switch mounting band.

### <Switch bracket>

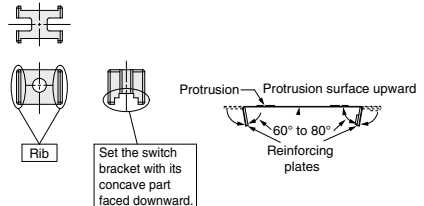

CHK

CHK□

CHN

CHM

CHS□

CH2□

CHA

Related Products

D-□

## How to Mount and Move the Auto Switch

### ⚠ Caution

1. Tighten the screw under the specified torque when mounting auto switch.
2. Set the auto switch mounting band perpendicularly to cylinder tube.

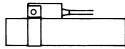

Mounting correctly

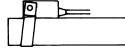

Mounting incorrectly

### <Applicable auto switch>

Solid state ..... D-G59, D-G5P, D-K59, D-G5BA  
 D-G59W, D-G5PW, D-K59W  
 D-G59F, D-G5NT, D-G5NB  
 Reed ..... D-B53, D-B54, D-B64, D-B59W

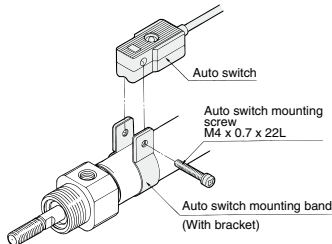

1. Put an auto switch mounting band on the cylinder tube and set it at the auto switch mounting position.
2. Put the mounting section of the auto switch between the auto switch mounting band mounting holes, then adjust the position of mounting holes of switch to those of mounting band.
3. Lightly thread the auto switch mounting screw through the mounting hole into the thread part of band fitting.
4. After reconfirming the detection position, tighten the auto switch mounting screw to secure the auto switch while properly contacting the auto switch bottom part and the cylinder tube. (The tightening torque of M4 screw should be about 1 to 1.2 N·m.)
5. Modification of the detection position should be made in the condition of 3.

### <Applicable auto switch>

Solid state ..... D-H7A1, D-H7A2, D-H7B, D-H7BA  
 D-H7C, D-H7NF, D-H7NW, D-H7PW  
 D-H7BW  
 Reed ..... D-C73, D-C76, D-C80, D-C73C, D-C80C

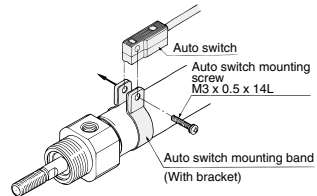

1. Put a mounting band on the cylinder tube and set it at the auto switch mounting position.
2. Put the mounting section of the auto switch between the auto switch mounting band mounting holes, then adjust the position of mounting holes of switch to those of mounting band.
3. Lightly thread the auto switch mounting screw through the mounting hole into the thread part of the auto switch mounting band fitting.
4. After setting the whole body to the detecting position by sliding, tighten the auto switch mounting screw to secure the auto switch while properly contacting the auto switch bottom part and the cylinder tube. (Tightening torque of M3 screw should be 0.8 to 1 N·m.)
5. Modification of the detection position should be made in the condition of 3.

## How to Mount and Move the Auto Switch

### Caution

1. Tighten the screw under the specified torque when mounting auto switch.
2. Set the auto switch mounting band perpendicularly to cylinder tube.

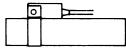

Mounting correctly

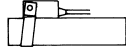

Mounting incorrectly

### <Applicable auto switch>

Solid state ..... D-G39, D-K39

Reed ..... D-A33, D-A34, D-A44

## How to Mount and Move the Auto Switch

D-A3, D-G3/K3 type

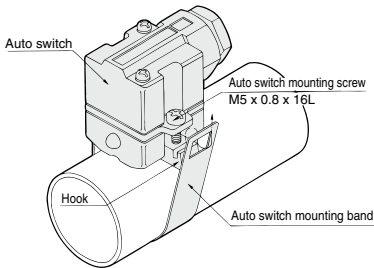

### D-A4

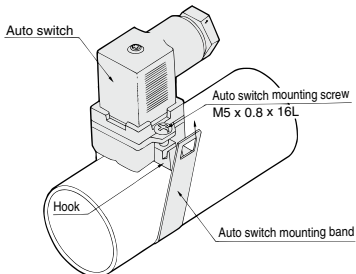

1. Loosen the auto switch mounting screws at both sides to pull down the hook.
2. Put an auto switch mounting band on the cylinder tube and set it at the auto switch mounting position, and then hook the band.
3. Screw lightly the auto switch mounting screw.
4. Set the whole body to the detecting position by sliding, tighten the mounting screw to secure the auto switch. (The tightening torque should be about 2 to 3 N·m.)
5. Modification of the detecting position should be made in the condition of 3.

CHQ

CHK

**CHN**

CHM

CHS

CH2

**CHA**

Related Products

D-

# Series CHN Model Selection 1

## Cylinder Cushion Selection

### Procedure

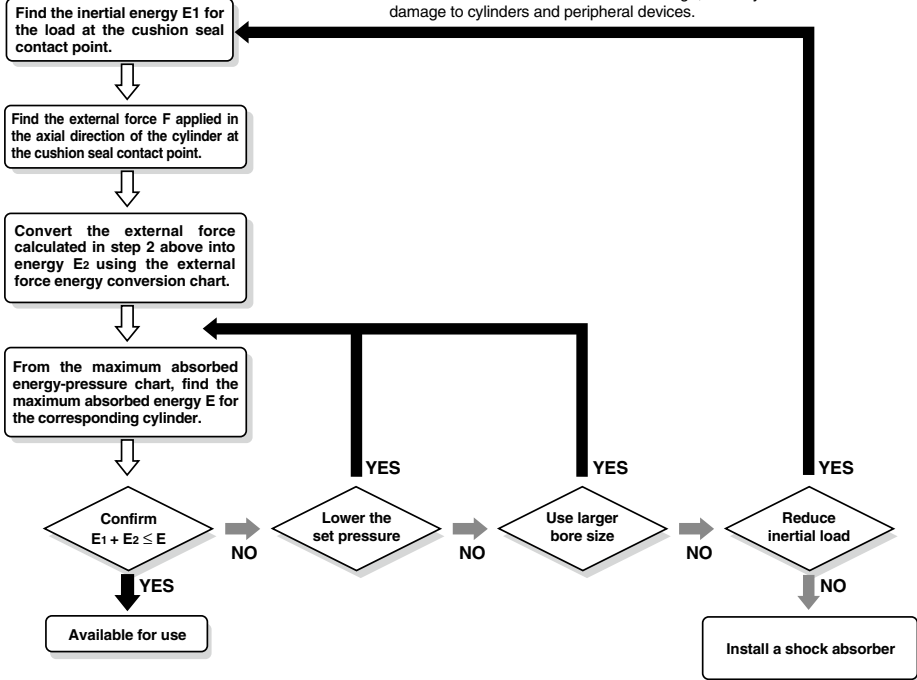

### Caution

Use a cylinder cushion within the maximum absorbed energy range.  
When used outside the allowable range, it may cause damage to cylinders and peripheral devices.

### Calculation Example

<Design conditions>

Cylinder: CHN25

Set pressure P1: 5 MPa

Load weight M: 50 kg

Piston speed V: 0.3 m/s (at the cushion seal contact point)

Load transfer direction: Downward  $\theta$ : 30°

(External force applied to the cylinder is gravity only).

Operating direction: Out

Gravitational acceleration g: 9.8 m/s<sup>2</sup>

<Calculation>

1. Load inertial energy  $E_1$  at the cushion seal contact point

$$E_1 = MV^2/2 = 50 \times 0.3^2/2 = 2.25\text{J}$$

2. External force F applied in axial direction of the cylinder at the cushion seal contact point

$$F = Mg \sin \theta = 50 \times 9.8 \times \sin 30^\circ = 245\text{N}$$

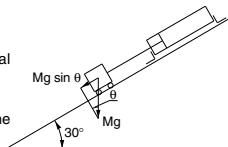

3. Convert the external force calculated in step 2 into energy  $E_2$ .

In the "External force and energy conversion chart" on page 313-2, draw a vertical line from the value of F (= 245N). The point where this line intersects with the diagonal line (0.27J) is the energy caused by external force.

$$E_2 = 0.27\text{J}$$

4. Find the maximum absorbed energy E for a cylinder.

In the "Maximum absorbed energy and pressure chart" on page 313-2, draw a vertical line from the set pressure 5MPa. The point where this line intersects with the line for  $\phi 25$  (3.7J) is the maximum absorbed energy.

$$E = 3.7\text{J}$$

5. Confirm that  $E_1 + E_2 \leq E$

$$E_1 + E_2 = 2.25 + 0.27 = 2.52\text{J}$$

$$\text{Since } E = 3.7\text{J}, E_1 + E_2 \leq E$$

Therefore, the cylinder cushion is available for use.

# Model Selection 2

## Maximum Absorbed Energy Chart & External Force and Energy Conversion Chart at Cushion Seal Contact Point

### Maximum absorbed energy pressure and chart in terms of cushion performance characteristics

Be sure to keep the combined values of kinetic energy of the load operated by the cylinder and the energy generated by the external force within the values that are shown in the bottom chart.

- CHQ**
- CHK**
- CHN**
- CHM**
- CHS**
- CH2**
- CHA**
- Related Products
- D-**

External force and energy conversion chart at cushion seal contact point

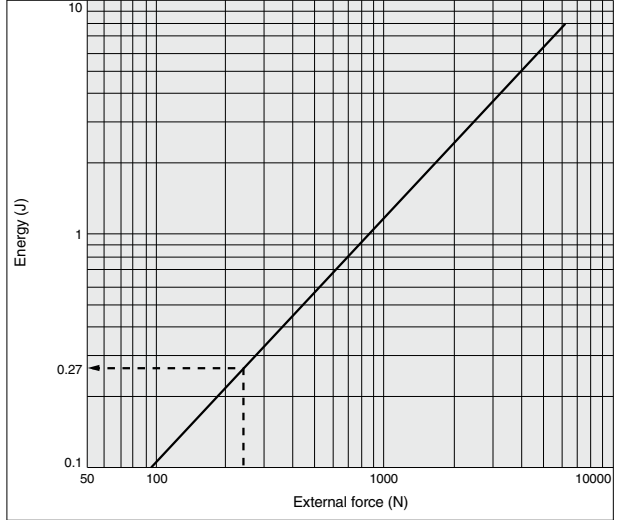

Maximum absorbed energy and pressure chart

