

**HIGH PERFORMANCE
TRIPLE MIRROR
PIR SENSOR**

**PIR-T15WE
PIR-T15AM (with ANTI-MASK)**

WIDE ANGLE PROTECTION
UP TO 49' (15m) × 80°

PIR-T40NAM (with ANTI-MASK)

VERTICAL CURTAIN PROTECTION
UP TO 135' (40m) × 10.5' (3.2m)

FEATURES

- 4 Selectable operation modes; low position, high position, pet (PIR-T15), middle (PIR-T40NAM) and high density
- Up to 49' (15m) × 80 degree coverage (PIR-T15WE/AM)
- Up to 135' (40m) × 10.5' (3.2m) coverage (PIR-T40NAM)
- 6.6' (2m) to 20' (6m) Installation height (depending on operation mode)
- High performance triple mirror optical system
- Precise detection area adjustment function
- Anti-masking function (PIR-T15AM/40NAM)
- Lightning surge protection
- Suitable for indoor and outdoor use (IP55)
- Available in white (W) and grey/black (G)



PIR-T15WE/AM (W)
PIR-T40NAM

PIR-T15WE/AM (G)

A unique triple mirror optical system with signal processing technology eliminates nuisance alarms from small animals

TRIPLE MIRROR OPTICAL SYSTEM

The unique combination of triple mirrors and three twin pyros enable 4 selectable operation modes including low position, high position, pet (PIR-T15), middle (PIR-T40NAM) and high density; from a mounting height of 6.6' (2m) to 20' (6m).

OPTIMISED DETECTION AREA

The triple mirror optical system features a geared mirror array allowing detection patterns to be dynamically optimised for maximum performance depending on the chosen mounting height and operation mode.

PET IMMUNITY

Independently controlled pyro devices in each optical unit use intelligent signal processing to eliminate nuisance alarms from small animals, and a dedicated pet operation mode (PIR-T15) further enhances discrimination performance against medium-sized animals.

PRECISE AREA ADJUSTMENT

Precise detection area adjustment is made possible by projecting coloured LED's onto the surface of each mirror -visible only from inside the detection zone during the alignment process- allowing sensitive zones to be fine-tuned to individual site requirements as desired. Unnecessary areas can be cancelled using the supplied area-masking sheet.

DESIGN CONSCIOUS

The PIR-T15's/40's unassuming design allows it to blend discreetly into any industrial, commercial or domestic environment, and the internally adjustable optic system helps to conceal the detection area and direction for more secure protection.

OTHER FUNCTIONS

Enhanced features including creep zone detection, near area cancellation, dual outputs, and lightning surge protection make the PIR-T15's/40's a key addition to the TAKEX family of high performance intrusion detection sensors.

<PARTS DESCRIPTION>

[Cover unit]

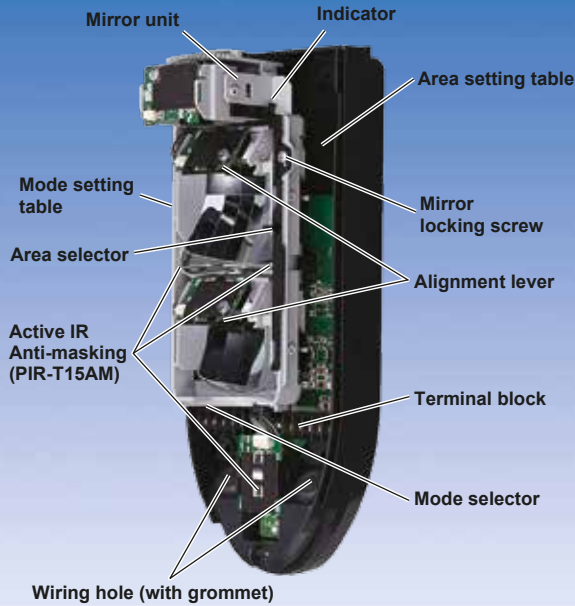

PIR-T15W/AM

[Sensor unit]

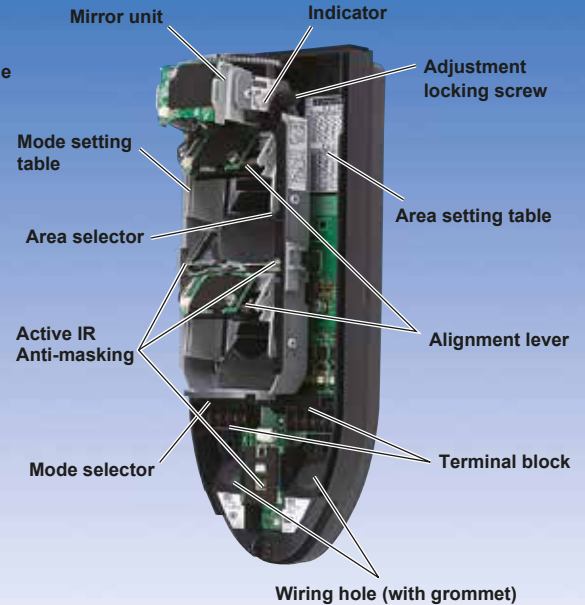

PIR-T40NAM

High performance



Triple mirror optical system

Triple mirror optical units combined with fuzzy logic signal processing substantially reduce nuisance alarms and activations.



Pet immunity

A dedicated pet operation mode (PIR-T15) further enhances discrimination performance against medium-sized animals in the detection area.



Detection area checking function

The unit is equipped with an LED detection area checking function for precise area adjustment and control.



Weather proof housing

The lid is designed to channel rain and snow away from the front surface of the sensor preventing nuisance alarms.



Anti-masking (PIR-T15AM/PIR-T40NAM)

An anti-masking alarm output signals any attempt to shield or cover the unit.



MASK



Lightning protection

Enhanced protection from induced lightning and other electrical surges.

Enhanced features



Varied installation height

Mounting height of 6.6' (2m) to 11.5' (3.5m) for normal operation (max. 20' (6m) in specialised operation mode).



Detection area adjustment

The mirror unit can be adjusted for optimal area setting.

PIR-T15WE/AM : Horizontal $\pm 45^\circ$, Vertical 17°

PIR-T40NAM : Horizontal $\pm 90^\circ$, Vertical 17°



Pole/Ceiling mounting

Various pole attachment brackets are available (sold separately).



Dual output

A second N.O. output is provided for signalling external devices.



Insect/Water protection

Suitable for indoor and outdoor use (IP55).

Eco friendly



Environmental design

Certified RoHS compliant: free from Lead, Mercury, Cadmium, Hexavalent Chromium, Polybrominated biphenyl, Polybrominated diphenyl ether.

PIR-T15WE/AM : Wide angle protection 15m

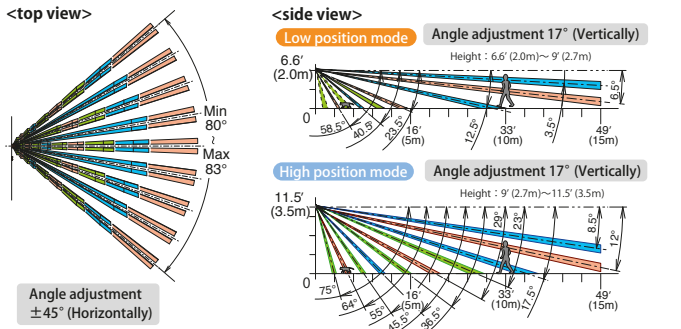

Standard operation

Low position mode
Height : 6.6' (2.0m) ~ 9' (2.7m)

High position mode
Height : 9' (2.7m) ~ 11.5' (3.5m)

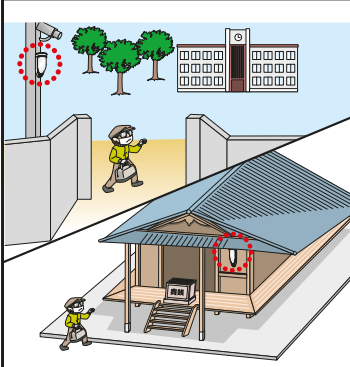

Signal CCTV, alarm, or lighting controllers in a wide range of intruder applications in the standard 'low position operation mode'.



Use to activate lighting systems for safety applications in warehouses, or for monitoring intrusion attempts from up to 11.5' (3.5m) mounting height.

Specialised operation

Pet mode
Height : 8' (2.5m) ~ 9.9' (3.0m)

High density mode
Height : 6.6' (2.0m) ~ 20' (6.0m)

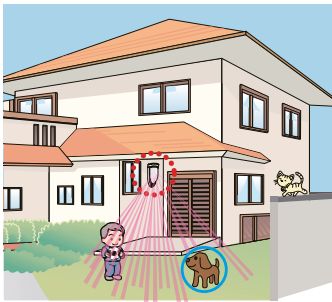

The dedicated 'Pet mode' further enhances discrimination performance against medium-sized animals moving within the detection area.

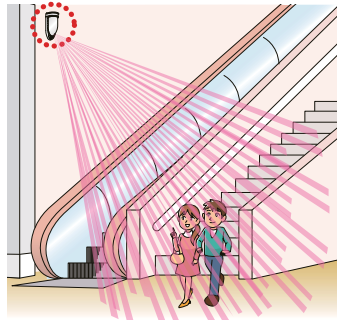

Mount up to 6m in height with a coverage of 49' (15m) x 80° 'high density mode', perfect for high installations such as open ceiling entrances.

※Maximum detection distance : 49' (15m) in all operation modes of PIR-T15WE/AM.

PIR-T40NAM : Vertical curtain protection 40m

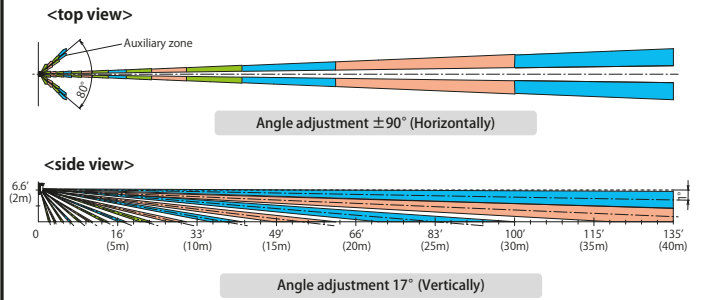

Standard operation

Low position mode
Height : 6.6' (2.0m) ~ 8.3' (2.5m)

Middle position mode
Height : 8.3' (2.5m) ~ 11.5' (3.5m)

High position mode
Height : 11.5' (3.5m) ~ 13' (4.0m)

Maximum detection distance
Low position mode : 135' (40m)
Middle position mode : 115' (35m)

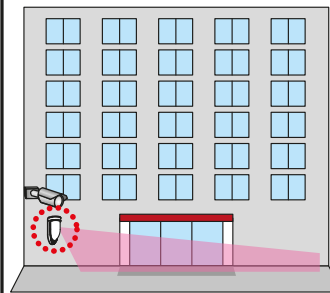

Rotating the mirrors horizontally by 90° allows intrusion detection along a wall.

Maximum detection distance : 100' (30m)

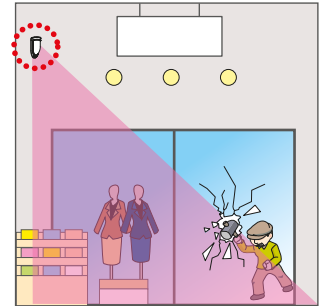

Installing in a high position can minimize the blind area

Specialised operation

High density mode
Height : 6.6' (2.0m) ~ 20' (6.0m)

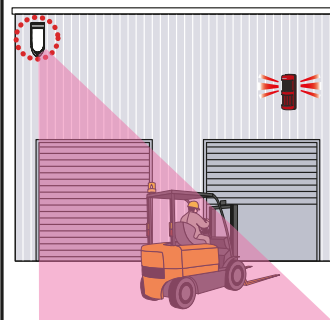

Installing the sensor in a high position will not obstruct the path of vehicles for traffic reminder systems.

Maximum detection distance : 150' (45m)

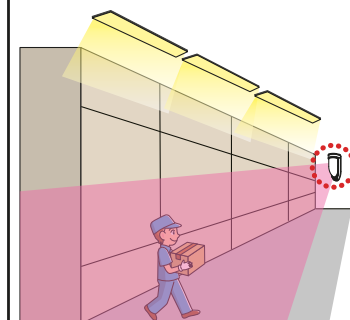

The long vertical curtain detection zone matches the lighting control for energy saving in factory or warehouse with tall shelving.

※Maximum detection distance : 135' (40m) in standard operation modes of PIR-T40NAM. 150' (45m) can be achieved in high density mode, however Pet Immunity function is disabled.

Feature of Passive sensor

Possible to detect human under fog.



Invisible by eye or CCTV

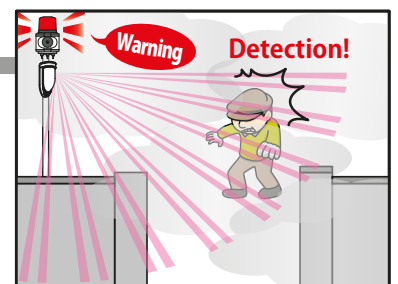

The passive sensor can detect.

TRIPLE MIRROR PASSIVE SENSOR

Detection area

PIR-T15WE/AM

In the setting of installation
height : 9' (2.7m)
distance : 50' (15m)

[Top view]

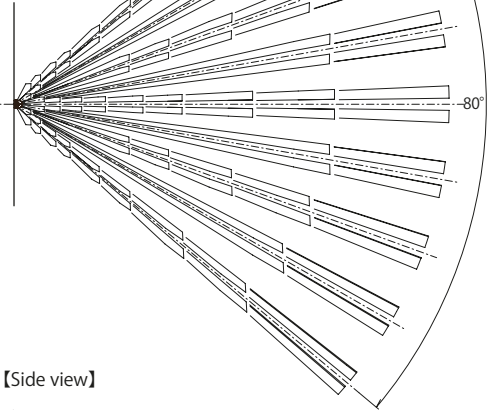

[Side view]

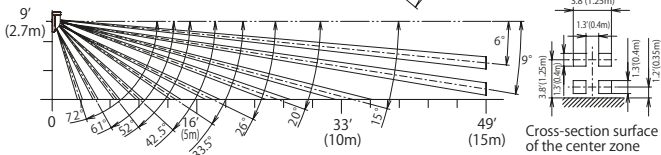

PIR-T40NAM

In the setting of installation
height : 6.6' (2.0m)
distance : 135' (40m)

[Top view]

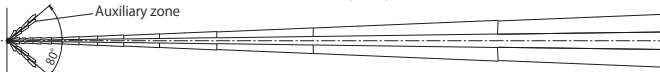

[Side view]

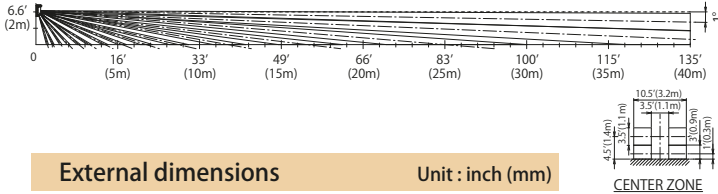

External dimensions

Unit : inch (mm)

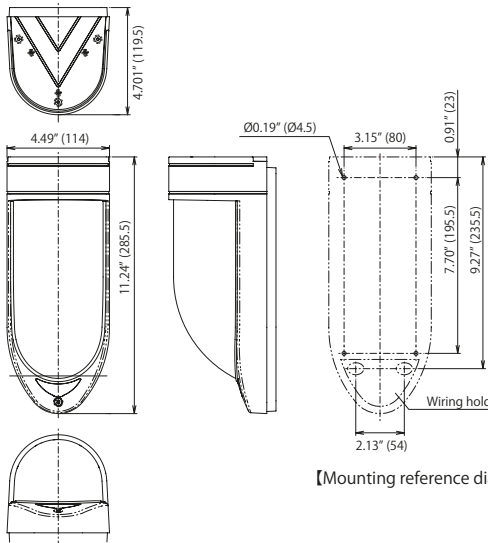

[Mounting reference diagram]

Terminal configuration

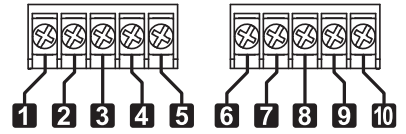

- 1 2 Power input (non-polarity)
9 to 28V DC/Max. 40mA
- 3 4 Alarm output - Contact method :
Dry semi-conductor contact
N.O./N.C. selectable
- 5 LED control input (L/C) - Control lighting on/off of the alarm LED
- 7 8 Tamper output - Contact method : Dry mechanical contact
- 9 10 Output for external device : Dry semi-conductor contact N.O.
- 6 7 Anti-masking output - Contact method : Dry semi-conductor contact N.C. (PIR-T15AM/40NAM model only)

Specifications

Model	Triple mirror passive sensor		
Model number	PIR-T15WE (W/G)	PIR-T15AM (W/G)	PIR-T40NAM
Detection system	Passive infrared		
Detection area	Wide angle (80°) detection Detection distance : 49'(15m), 108 rays (54 pairs)		Vertical curtain distance Detection distance: Max 150'(45m), 46 rays (23 pairs)
Power supply	9 to 28V DC (non-polarity)		
Current consumption	Max. 40mA		Max. 50mA
Alarm output	Contact method : Dry semi-conductor contact, N.C./N.O. selectable Contact operation : One-shot operation when detecting intrusion Continuous output in the event of cover monitor error Continuous output in the event of alignment position error Continuous output in the event of self diagnosis error Continuous output in the event of power voltage error Continuous output in the event of long-term diagnosis error (PIR-T15) Contact rating : 24V (AC/DC) 0.25A (resistive load) (built-in contact protective resistor 3.3Ω)		
External output	Contact method : Dry semi-conductor contact N.O. Contact operation : One-shot operation/Off delay operation selectable when detecting intrusion Contact rating : 24V (AC/DC) 0.25A (resistive load) (built-in contact protective resistor 3.3Ω)		
Tamper output	Contact method : Dry mechanical contact, N.C. Contact operation : Continuous output Contact rating : 24V (AC/DC) 0.1A (resistive load) (built-in contact protective resistor 3.3Ω)		
Anti-masking output	N/A		Contact method : Dry semi-conductor contact N.C. Contact operation : Continuously output when an object is placed in front of the lens (until normal recovery) Contact rating : 24V (AC/DC) 0.25A (resistive load) (built-in protective resistor 3.3Ω)
Alarm LED	Red LED : Blinks* during warm up Lights up* when detecting intrusion Continuously blinks in the event of cover monitor error Continuously lit in the event of alignment position error Continuously blinks in the event of self diagnosis error Continuously lit in the event of power voltage error Continuously blinks in the event of long-term diagnosis error (PIR-T15) Continuously blinks in the event of Anti-masking error (PIR-T15AM/40NAM) (*ON/OFF selectable using the mode selector)		
Memory LED	Red LED : Blinks for 3 minutes during memory display, Auto reset operation either of continuous lighting for 47 minutes or blinking for 50 minutes selectable (Blinks to lights/blinks, ON/OFF selectable using the mode selector)		
Functions	Sensitivity selection, Operation mode selection, Alarm memory LED, Selfdiagnosis, Low voltage monitoring, Temperature compensation, Tamper, LED area checker, Environmental adjustment, Creep zone detection, Walk test mode, Near area cancellation, Long-term diagnosis (PIR-T15) Anti-masking (PIR-T15AM/40NAM)		
Mounting positions	6.6' to 20'(2.0 to 6.0m) (varies depending on the operation mode) • Low position mode : 6.6' to 8.3'(2.0 to 2.5m) Maximum detection distance : 135'(40m) • Middle position mode : 8.3' to 11.5'(2.5 to 3.5m) Maximum detection distance : 115'(35m) • High position mode : 11.5' to 13'(3.5 to 4.0m) Maximum detection distance : 100'(30m) • High density mode : 6.6' to 20'(2.0 to 6.0m) Maximum detection distance : 150'(45m)		
Area angle adjustment range	Horizontal direction : ±45° (by 5° pitch) Vertical direction : 17° (no stage adjustment)		±90° (in 5° steps) 17° (no stage adjustment)
Ambient temperature range	-25~+55°C (no condensation and freezing)		
Installation place	Indoor/outdoor wall surface *Can be mounted on poles and ceilings (or under eaves) using optional accessories		
IP rating	IP55		
Connections	Terminals (M2.6 self up terminal)		
Weight	Approx. 600g		
Appearance	Body, Window : resin		

Options

- Pole attachment <BP-32>



- Pole attachment <BP-02>



- Ceiling attachment <KP-32>



TAKEX TAKENAKA ENGINEERING CO., LTD.

In Japan

Takenaka Engineering Co., Ltd.
83-1, Gojo-sotokan, Higashino,
Yamashina-ku, Kyoto 607-8156, Japan
Tel : 81-75-501-6651
Fax : 81-75-593-3816
http : // www. takex-eng. co. jp

In the U.S.

Takex America Inc.
151 San Zenon Way
Sunnyvale, CA 94086 U.S.A.
Tel : 408-747-0100
Fax : 408-734-1100
http : // www. takex. com

In Australia

Takex America Inc.
4/15 Howleys Road Notting Hill,
3168 Victoria, Australia
Tel : 03-9546-0533
Fax : 03-9547-9450

In the U.K.

Takex Europe Ltd.
Takex House, Aviary Court, Wade Road,
Basingstoke, Hampshire. RG24 8PE, U.K.
Tel : (+44) 01256-475555
Fax : (+44) 01256-466268
http : // www. takexeurope. com

Please note:

This sensor is designed to detect intrusion and to initiate an alarm; it is not a burglary or a crime preventing device. TAKEX is not responsible for damage, injury or losses caused by accident, theft, Acts of God (including inductive surge by lightning), abuse, misuse, abnormal usage, faulty installation or improper maintenance.