



PCE Americas Inc.
 711 Commerce Way
 Suite 8
 Jupiter
 FL-33458
 USA
 From outside US: +1
 Tel: (561) 320-9162
 Fax: (561) 320-9176
 info@pce-americas.com

PCE Instruments UK Ltd.
 Units 12/13
 Southpoint Business Park
 Ensign way
 Hampshire / Southampton
 United Kingdom, SO31 4RF
 From outside UK: +44
 Tel: (0) 2380 98703 0
 Fax: (0) 2380 98703 9
 info@pce-instruments.com

OPERATION MANUAL

GLOSS METER PCE-IGM / SGM Series

www.pce-instruments.com/english
www.pce-instruments.com

Safety Instructions

Attention: The instrument is a safe device. Before operating, please read the safety instructions and strictly comply with the following terms to avoid unexpected damages. We shall not be liable for any losses by incorrect operation.

Battery	<p>The device configures a built -in battery. Please use the original one. Do not use other batteries to prevent unnecessary damages.</p> <p>Do not dis assemble, extrude or heat the battery.</p> <p>When fully charged, please cut off the external power supply in time.</p> <p>Please charge the battery biweekly if long time not use. Otherwise, it may cause the damage of the battery.</p> <p>For the first three times, please run out the power and charge full to ensure the battery reach the optimal state.</p>
External Power Source	<p>Please use the original power adapter when charging. Otherwise, it will shorten the battery life or cause explosion.</p> <p>Please cut off the external power source if you don't use it for a long time.</p>
Gloss Meter	<p>Do not use the device in inflammable and explosive environment.</p> <p>Do not disassemble the device which will cause damage explosion.</p> <p>Please stop using the machine when you smell something burning and send it back to repair center.</p>

Content

Introduction

Cautions

1 External Structure Description

2 Operating Instruction

2.1 Turning On/Off

2.2 Calibration

2.2.1 Calibration

2.2.2 Change Calibration Value

2.3 Measurement

2.3.1 Basic Mode

2.3.2 Statistical Mode

2.3.3 Continuous Mode

2.4 Connecting to PC

2.5 Print

3 System Function Description

3.1 Data Management

3.1.1 Check Record

3.1.2 Delete Record

3.2 Mode Selection

3.3 Mode Parameter

3.3.1 Average Measure under Basic Mode

3.3.2 Statistical Mode Parameter

3.3.3 Continuous Mode Parameter

3.4 Angle Selection

3.5 Tolerance Setting

3.6 Function Setting

3.6.1 Auto Save

3.6.2 Time Setting

3.6.3 Language Setting

3.6.4 Backlight Time

3.6.5 Backlight Brightness

3.6.6 Operation Habit

3.6.7 Buzzer Switch

3.6.8 Restore Factory Settings

4 Routine Maintenance

5 Technical Specifications

Introduction

The gloss meter is in accordance with ISO 2813(International Standard) and GB/T 9754(China National Standard). The gloss meter features with large touch screen and QC software. It has the characters of easy to use, stable performance and precise measurement. This instrument is powered by built-in Li-ion battery.

Advantages

1. Large touch screen (3.5inch), high resolution (480*320), full-view display.
2. Comply with ISO 2813, ASTM D 523, GB/T 9754 standards.
3. Aesthetic design perfectly combined with ergonomics structure.
4. Three measurement angles (20°, 60°, 85°) , can measure simultaneously(except the single-angle gloss meter).
5. Three operating modes, multi-functions setting.
6. QC software with powerful extending function.
7. Input standard data manually, easy to operate.
8. High hardware configuration with multiple innovative technologies.
9. Auto power-off function to save electricity consumption.

Cautions

1. The gloss meter is a precise measuring instrument. Please avoid dramatic change of external environment when measuring. Those changes including the flicker of surrounding light, the rapid change of temperature and humidity will affect the measuring accuracy.
2. Keep the instrument balanceable. Make sure the measuring aperture cling to the test sample, and no shaking or shifting when measuring. Please prevent the gloss meter from fierce collision or crash. This device is not water-proof. Do not use it in the environment of high humidity or in the mist.
3. Keep the device clean. Avoid dust, powder or solid particles entering the measuring aperture and the devices.
4. After using, please turn it off. Keep the instrument and calibration board in the instrument case.
5. Users can not do any changes on the device without permission. Since it may affect measuring accuracy or even damage the device.

1. External Constructions

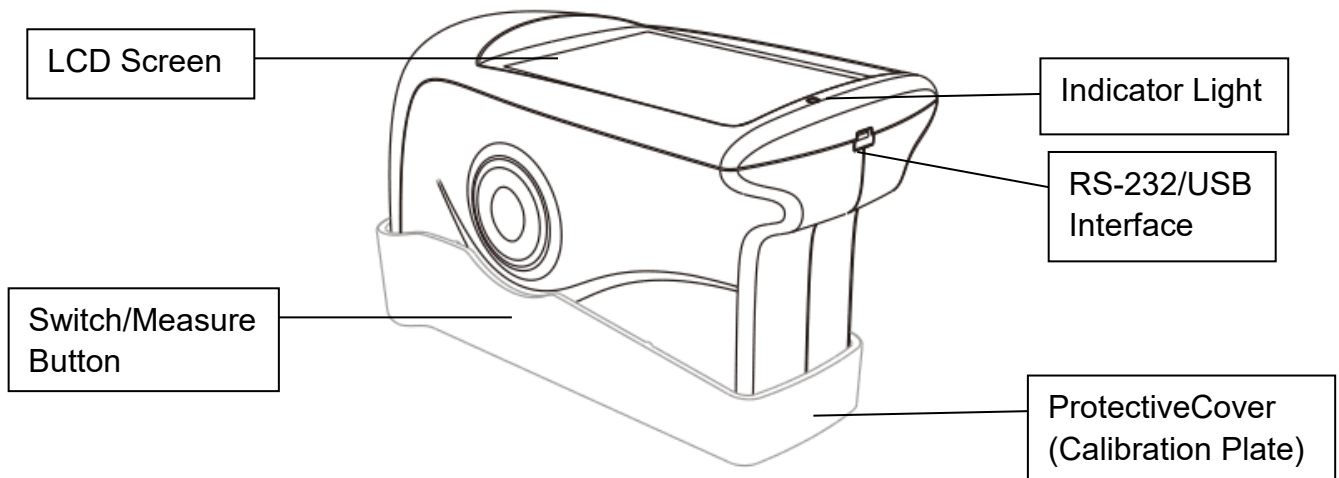

Figure 1 External Constructions

Button Function Instruction

LCD Screen: Display measuring data and instrument operation navigation.

Switch/Measure button: Long-press the button 3 seconds to turn on or turn off the gloss meter. Short press the button is to measure.

Indicator Light: When turning on, it will show green light. After startup, the light is off. Low power and charging status will show red light. Fully charged will show green light.

USB interface: This interface is a common interface. The instrument automatically judges the connection status. USB interface is used to connect transfer data to PC. RS-232 interface is used to connect to the printer. USB cable can connect power adapter and **computer** for charging the gloss meter (specification for external adapter is: 5V=2A).

Protective Cover (Calibration plate): It is to protective the measuring aperture. Built-in calibration plate is used for instrument calibrating.

Attention: The method to separate the protective cover from the instrument is shown in figure 2. Hold the instrument with one hand, the other hand hold the protective cover, and then separate it according to the "Open" mark. You only need to separate it from one side. Do not separate it from two sides.

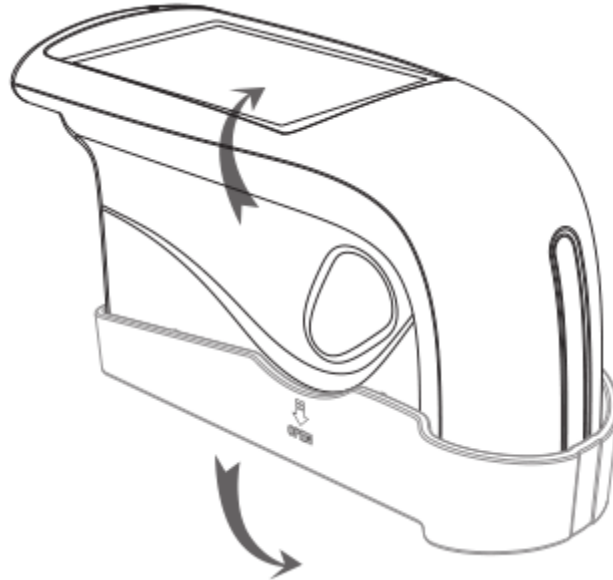

Figure 2 Separation Method

2. Operating Instruction

2.1 Turn on/off

Long-press the switch button 3 seconds to turn on the instrument. The LCD screen will display boot logo. After a few seconds, it will enter into the measurement interface automatically, as shown in figure 3. Long-press the switch button 3 seconds again, it will be turn off.

Basic Mode				
T005			16:35	2015.10.23
		20°	60°	85°
T001	T102316	22.5	21.5	21.3
T002	T102316	23.8	24.8	26.6
T003	T102316	33.3	31.5	32.7
T004	T102316	45.5	42.9	42.1
T005	T102316	60.5	66.3	63.9
Delete			Menu	

Figure 3 Standard Mode Measurement

2.2 Calibration

In figure 3, click “Menu” to get into main menu as shown in figure 4. Select “Calibration” to enter into Calibration interface as shown in figure 5.

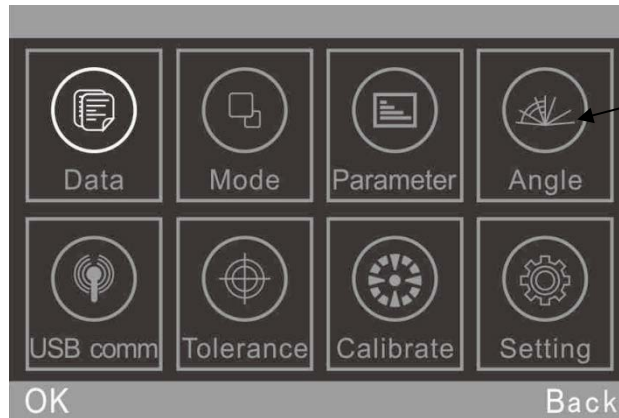

Remarks: Single angle gloss meter doesn't have angle selection option. The substitute option is basic mode average measurement.

Figure 4 Main Menu

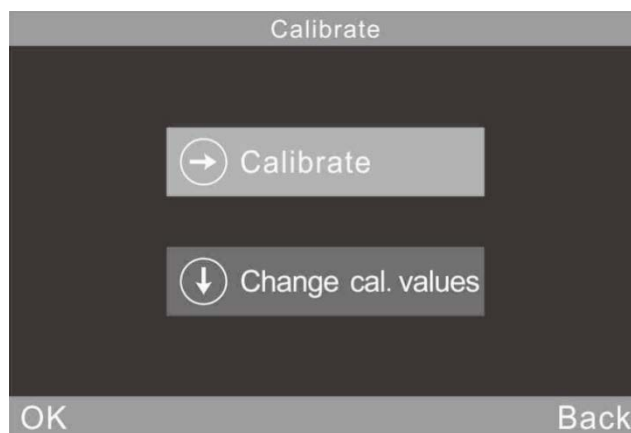

Figure 5 Sub-menu Interface for Calibration

2.2.1 Calibration

Click “Calibrate”, it will remind you to put away the calibration plate. Make sure the calibration plate is installed well on the instrument. Click “OK” or press measure button to start calibration.

When operating environment change (such as the rapid change of temperature, altitude and humidity), it must do calibration. In order to ensure the accuracy, please use the original standard plate for calibration. The dust on the standard plate will affect calibration accuracy. Please clean the standard plate and ensure it's clean when calibrating.

The Standard plate is a precise optical component. Please avoid it from **strong light**. Due to environment factors, the gloss value of standard plate will change over time. Therefore, it's better to send it back to the factory or qualified local National Institute of Metrology for the calibration. (Once a year)

Attention: The SN code (serial number) corresponds to the internal number of the instrument. In the calibration interface, it will show the “Calibration Plate Number”. It is more important when you have 2pcs or more gloss meters in

hand.

2.2.2 Change Calibration Values

Click “Change cal. values”, users can select “Change 20° cal. value”, “Change 60° cal. value” and “Change 85° cal. value”.

Attention:

1. **Take caution in operating this function. It's better to operate by manufacturer or qualified metrology institutes.** The calibration value needs to be modified only when it is different from the actual calibration plate value. Before modifying the standard value, please backup the original standard value.

2. Single angle instrument only can modify one angle value.

2.3 Measurement

The instrument has three measurement modes: “Basic Mode”, “Statistical Mode” and “Continuous Mode”. Click “Mode” in main menu, entering into the interface as shown in figure 6.

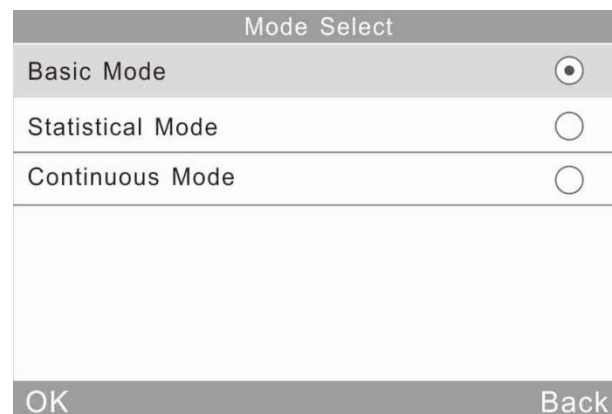



Figure 6 Mode Selection

Basic Mode: It is a basic sample test mode which belongs to single measurement. The results will be saved automatically each time. Those data can be used as the standard in Statistic Mode. It can display 5 sets test **data simultaneously**.

Statistical Mode: It has statistical evaluation function and can multi-measure a single sample. If open the difference switch, you can get the results comparing with standard sample.

Continuous Mode: The continuous measuring times can be set to 99 and you can set interval time. When press “Test” button, the instrument starts to measure automatically and will stop measurements according to the settings. If press “Test” button during the test, it will pause or end the current

measurement. This mode is used to measure large area samples and evaluate homogeneity of large-area samples.

The Instrument has three measurement angles: 20°, 60° and 85°. You can select it by clicking “Mode” in Main Menu or click icon () to enter the interface as shown in figure 7. (Remarks: Single angle gloss meter doesn't have this option)

Angle Select	
20°	<input type="radio"/>
60°	<input type="radio"/>
85°	<input type="radio"/>
20° 60°	<input type="radio"/>
60° 85°	<input type="radio"/>
20° 60° 85°	<input checked="" type="radio"/>
OK	Back

Figure 7 Angle Selection

2.3.1 Basic Mode Measurement

This mode also comes with average measurement function. Details will present on chapter 3.3.1 Basic Mode Average.

(1) Single angle measurement in Basic Mode: e.g.: 60°. Press “Test” button will measure the gloss value under 60°, as shown in figure 8.

Basic Mode		
T005		16:35 2015.10.23
60°		
T001	T102316	21.5
T002	T102316	24.8
T003	T102316	31.5
T004	T102316	42.9
T005	T102316	66.3
Delete	Menu	

Remarks: This icon in single angle gloss meter will only show one angle and cannot click for selection.

Figure 8 Single angle measurement under Basic Mode

Click “Basic Mode” at the top of the interface. It will enter average measurement interface directly.

“T005” at the upper left means the record number of current measurement.

The number begins with letter “T”. The icon () is a shortcut key for angle selection. (Remarks: Single gloss meter doesn’t have this option.) “16:33” and “2015.10.23” are time and date.

“T001-T005” is the record number of five measurements.

“T102316” is a default name of measuring record. It is making up of “T”+“month”+“day”, “T” means basic record, “102316” means the measuring record at 16:00 pm on 23th October.

Click any name. It will pop up a dialog box with two options “Delete Record” and “Edit Name” as shown in figure 9. If click “Delete Record”, it will display a warning interface as shown in figure 22. Click “Ok”, this record will be deleted. If click “Edit Name”, you can modify the name with maximum eight-bit character (only numbers or letters) as shown in figure 23.

Click “Delete” at lower-left corner to delete the current record.

“60°” means the current measurement is under angle 60°.

The last record “66.3” in yellow is the current test data.

Click “Menu” at lower-right corner to enter the main menu interface.

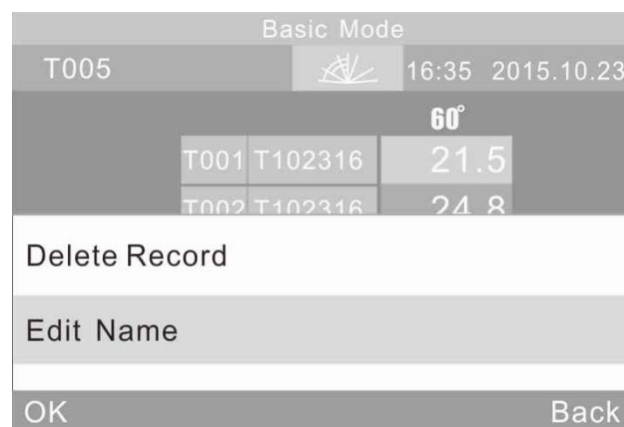

Figure 9 Click Name to Enter the Operation Interface

(2) Multi-angle measurement under Basic Mode: as shown in figure 10, the angles are “20°60°85°”. (Remarks: Single gloss meter doesn’t have this option.)



Basic Mode				
T005			16:35	2015.10.23
		20°	60°	85°
T001	T102316	22.5	21.5	21.3
T002	T102316	23.8	24.8	26.6
T003	T102316	33.3	31.5	32.7
T004	T102316	45.5	42.9	42.1
T005	T102316	60.5	66.3	63.9
Delete		Menu		

Figure 10 Multi-angle Measurement

2.3.3 Statistical Mode Measurement

(1) Statistical Mode: A single angle measurement is shown in figure 11.

Statistics Measure						
S006	S102316		16:35	2015.10.23		
T003	75.2				6/6	
		60°	73.5			
	Mean	Max	Min	Std. Dev	Diff.	Result
60°	74.8	76.1	72.9	1.5	-0.4	Pass
Delete		Menu				

Remarks: This icon in single angle gloss meter will only show one angle and cannot click for selection.

Figure 11 Single Angle Measurement under Statistical Mode

Click “Statistics Measure” at the top of the interface. It will enter statistical mode parameter settings directly.

“S006” means the record number of current measurement which begins with letter “S”.

The icon () is a shortcut key for angle selection. (Remarks: Single gloss meter doesn't have this option.)

“6/6”: The first “6” means you have finished the 6th measurement, the second “6” means the statistical measurement times is 6. How to set times for measurements will explain on chapter 3.3.2 Statistics Mode Parameter. When finished all measurements, those value will be saved as a complete statistics record automatically.

“75.2” means the last measuring value.

“74.8, 76.1, 72.9, 1.5, -0.4” means average value, max value, min value, standard deviation, difference value respectively.

$$s = \sqrt{\frac{1}{n-1} \sum_{i=1}^n (x_i - \bar{x})^2}$$

Standard Deviation: the formula is

Difference: The difference between the sample and the target value.

Result: “Pass” means the sample is qualified and the result is in the tolerance range. “Fail” means the sample is unqualified and the result is not in the tolerance range (Tolerance setting is explained in chapter 3.5).

After completing the current testing, click “Delete” will delete this record.

Attention: Only when the difference switch is open, the standard value, standard deviation and difference will display.

(2) Multi-angle measurement in Statistical Mode: as shown in figure 12, the angles are “20°60°85°”. (Remarks: Single angle gloss meter doesn’t have this option).



Statistics Measure						
S006	S102316		16:35	2015.10.23		
T003	44.5	75.2	89.8	6/6		
20°	44.6	60°	73.5	85°	90.3	
	Mean	Max	Min	Std. Dev	Diff.	Result
20°	44.3	47.7	41.9	2.8	-0.2	Pass
60°	74.8	76.1	72.9	1.5	-0.4	Pass
85°	90.4	90.8	89.8	0.5	-0.6	Pass
Delete			Menu			

Figure 12 Multi-angle measurement under Statistical Mode

“T003 44.5 75.2 89.8” is the standard value of Statistics Measure (T003 is the Standard record number, 44.5 is the value under angle 20°, 75.3 is the value under angle of 60°, 89.8 is the value under angle of 85°)

2.3.3 Continuous Mode

(1)Single angle measurement: as shown in figure 13.

Continuous Measure				
C006	C102316		16:35	2015.10.23
6/8				
	Value	Mean	Max	Min
60°	76.0	74.8	76.1	72.9
Delete		Menu		

Remarks: This icon in single angle gloss meter only shows one angle and cannot click for selection.

Figure 13 Continuous Mode-Single Angle Measurement

Click “Continuous Measure” at the top of the interface. It will enter continuous mode parameter settings directly.

“C006” is the current measurement number which begins with the letter “C”. The icon () is a shortcut key for angle selection. (Remarks: Single angle gloss meter doesn’t have this option)

“C102316” is a default name for measurement record. It is made up of “C”+“month”+“day”, “C” means continuous record, “102316” means it’s measuring at 16:00 pm on 23th October. Click the record name, you can modify it (Max: 8-bit numbers or characters), as shown in Figure 23.

(2) Multi-angles measurement: as shown in figure 14. The angles are “20°60°85°” (Remark: single angle gloss meter doesn’t have this option).

Continuous Measure				
C006	C102316		16:35	2015.10.23
6/8				
	Value	Mean	Max	Min
20°	42.1	44.3	47.7	41.9
60°	76.0	74.8	76.1	72.9
85°	90.6	90.4	90.8	89.8
Delete		Menu		

Figure 14 Multi-angles measurement

2.4 Connecting to PC

Click “Comm” to enter the interface shown in figure 15. Follow the tips to connect instrument to PC. Use USB cable to connect the instrument with PC first. Click “OK”, the instrument will enter “Communicating...”, and then you can control the instrument through the software.(Precondition: please install the software on your PC properly. The software and installation instruction are in CD.)



Figure 15 Communicating

2.5 Print

Connect the instrument to mini printer. It will print measurement data automatically when measuring.

3 System Function Description

3.1 Data Management

Click “Data” in main menu to enter data management interface as shown in figure 16. Data management is mainly for checking and operating the records.

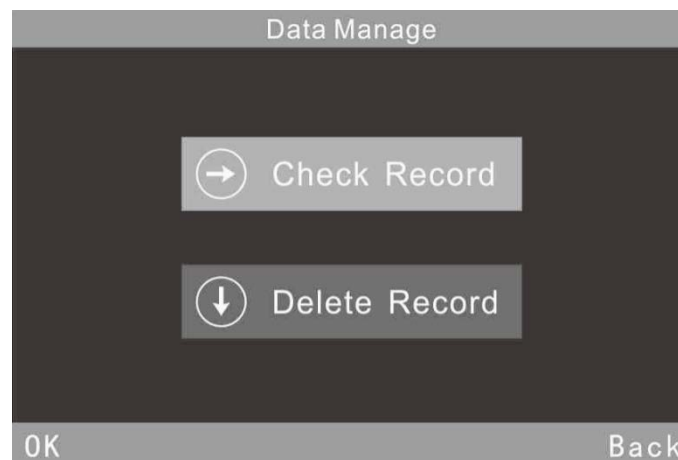

Figure 16 Data Management

3.1.1 Check Record

Click “Check Record”, shown in figure 17, you can check basic record, **statistical record and continuous record.** (此处单词间要注意空格)

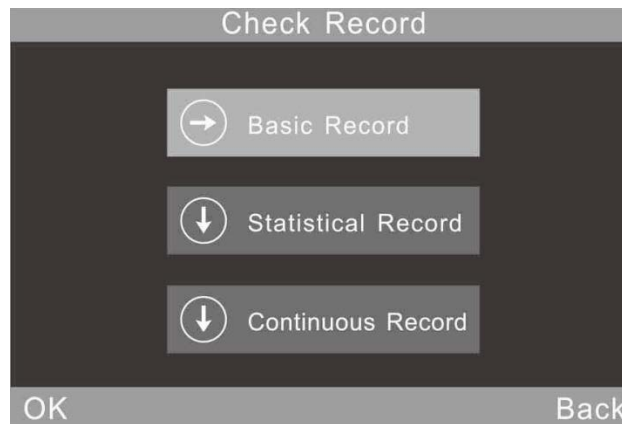

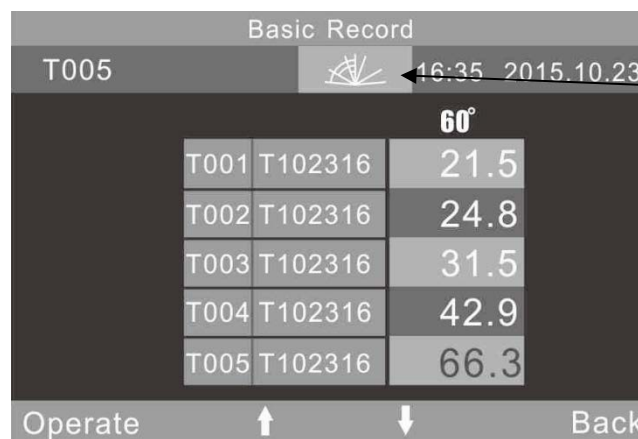

Figure 17 Check Record

You can check records in single angle mode, double angle mode and tri-angle mode. Click the shortcut icon () to select angles directly, as shown in figure 7. (Remarks: Single angle gloss meter don't have this option)

(1) Check Basic Record

There are 5 record one page on the screen. When choose angle 60°, please see Figure 18. When choose tri-angle “20°60°85°”, please see Figure 19.



Remarks: This icon in single angle gloss meter only shows one angle and cannot click it for selection.

Figure 18 Single Angle Record in Basic Mode

Basic Record				
T005			16:35	2015.10.23
		20°	60°	85°
T001	T102316	22.5	21.5	21.3
T002	T102316	23.8	24.8	26.6
T003	T102316	33.3	31.5	32.7
T004	T102316	45.5	42.9	42.1
T005	T102316	60.5	66.3	63.9

Operate ↑ ↓ Back

Figure 19 Tri-angle Record in Basic Mode

You can check record by clicking “↑” and “↓”. When click one record before release, the No. and name of this record will become yellow, as shown in figure 20. After release, it will enter the operation interface as shown in figure 21.

When click “Operation”, you can operate the last record.

Basic Record				
T005			16:35	2015.10.23
		20°	60°	85°
T001	T102316	22.5	21.5	21.3
T002	T102316	23.8	24.8	26.6
T003	T102316	33.3	31.5	32.7
T004	T102316	45.5	42.9	42.1
T005	T102316	60.5	66.3	63.9

Operate ↑ ↓ Back

Figure 20 Select Basic Record

Basic Record	
T005	16:35 2015.10.23
60°	
Delete Record	
Edit Name	
Standard Entering	
Search	
OK	Back

Figure 21 Basic Record Operation (此处图片更换)

Delete Record: Click "Delete Record", it will pop up a warning interface as shown in figure 22. Click "OK", the selected record will be deleted. Click "Back" to give up the current operation.

Edit Record Name: Click "Edit Name" to edit the current record name (Max: 8-bit characters). After completing it, click "OK", then the modified name will be saved.

Standard Entering: Click "Standard Entering", the selected record will be transferred as a standard record of statistic measurement.

Search: Users can search the record by "Search Index" and "Search Name" if the instrument has stored too much data.



Figure 22 Warning for Deleting Record

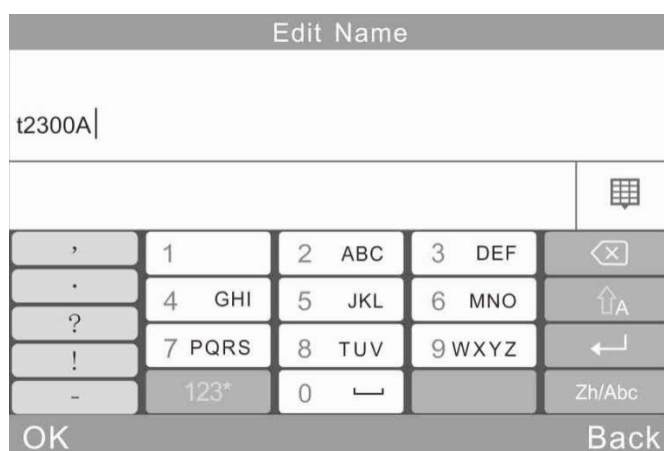

Figure 23 Edit Name

(2) Check Statistical Record

When choose the angle 60°, it will display only one record, shown in Figure 24.
 When choose the angle 20°60°85°, please see Figure 25.
 Click the record name “S102316”, you can modify it, shown in Figure 23.

Statistical Record						
S006	S102316		16:35	2015.10.23		
T003	75.2					
	Mean	Max	Min	Std. Dev	Diff.	Result
60°	74.8	76.1	72.9	1.5	-0.4	Pass
Operate ↑ ↓ Back						

Figure 24 Single Angle Measurement in Statistical Mode

Statistical Record						
S006	S102316		16:35	2015.10.23		
T003	44.5	75.2	89.8			
	Mean	Max	Min	Std. Dev	Diff.	Result
20°	44.3	47.7	41.9	2.8	-0.2	Pass
60°	74.8	76.1	72.9	1.5	-0.4	Pass
85°	90.4	90.8	89.8	0.5	-0.6	Pass
Operate ↑ ↓ Back						

Figure 25 Tri-angle Measurement in Statistical Mode

Statistical Record						
S006	S102316		16:35	2015.10.23		
T003	44.5	75.2	89.8			
	Mean	Max	Min	Std. Dev	Diff.	Result
Delete Record						
Edit Name						
Search						
OK Back						

Figure 26 Operation Menu of Statistical Record (此处图片更换)

(3) Check Continuous Record

This operation is same with Check **Statistical Record**, please refer to the former description.

3.1.2 Delete Record

Click “Delete Record” in “Data”, shown in figure 27. There are three modes: “Delete Basic Record”, “Delete Statistical Record” and “Delete Continuous Record”.



Figure 27 Delete Record



Figure 28 Warning Interface

3.2 Mode Selection

Click “Mode” to select different measurement mode according to requirements, as shown in Figure 6.

3.3 Mode Parameter

Click “Parameter” to set the mode parameters, as shown in Figure 29.

Or click the name at the top of the interface to enter corresponding mode parameters setting interface directly.

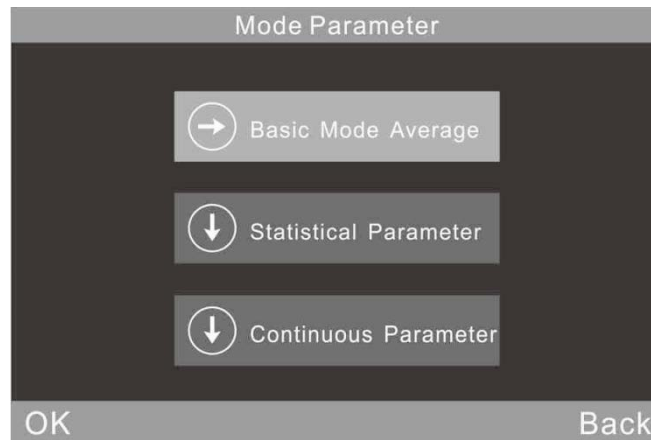

Remarks: Basic Mode Average function of single angle gloss meter is in the main menu.

Figure 29 Sub-menu of Mode Parameter

3.3.1 Average Measurement in Basic Mode

This is an additional functional for Basic Mode. Click “Basic Mode Average” to set measurement times, as shown in figure 30. The number range is 0-99.

Users can modify measurement angle, edit name and delete record in this mode. All testing data will be saved in basic record.

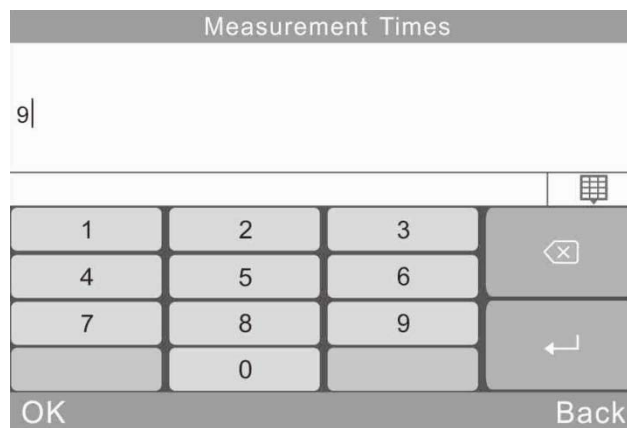

Figure 30 Measurement Times Setting

Basic Mode				
T005			16:35	2015.10.23
6/9		20°	60°	85°
		60.5	66.3	63.9
T001	T102316	22.5	21.5	21.3
T002	T102316	23.8	24.8	26.6
T003	T102316	33.3	31.5	32.7
T004	T102316	45.5	42.9	42.1
T005	T102316	60.1	66.0	63.8
Delete		Menu		

Figure 31 Multi-angle Measurement in Basic Mode Average

3.3.2 Statistical Mode Parameter

Users can set measurement times, difference switch, select standard and input standard.

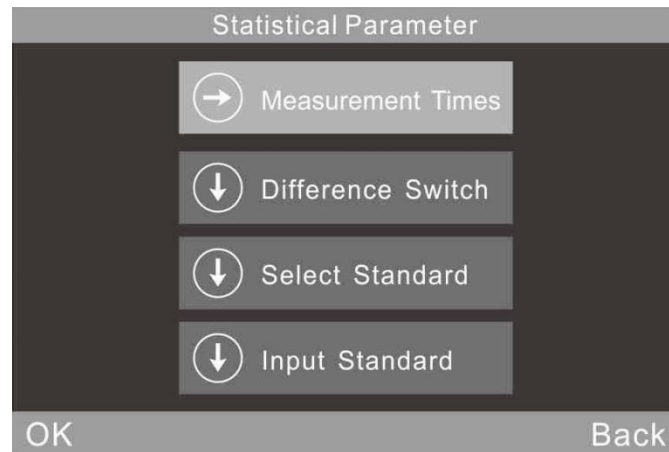

Figure 32 Sub-menu of Statistical Mode Parameter

(1) Measurement Times

You can set measurement times (range 1 to 99).

The instrument will calculate automatically and display average value (mean), Max value, Min value. If open the difference switch, it will also display standard deviation, difference value and results.

(2) Difference Switch

When the difference switch is closed, statistic measurement only evaluates the average value, Max value and Min value. It will not show the comparative function. In figure 33, upper-left part doesn't show the standard data, only show the Mean value, Max value and Min value.

When open the difference switch, it will have the function of comparing data with standard sample, as shown in figure 11 or figure 12(Attention: Single angle gloss meter only shows single angle value)

Statistics Measure					
S006	S102411		16:35	2015.10.23	
				6/6	
20°	44.6	60°	73.5	85°	90.3
	Mean	Max	Min		
20°	44.3	47.7	41.9		
60°	74.8	76.1	72.9		
85°	90.4	90.8	89.8		
Delete			Menu		

Figure 33 Statistic Measurement When Difference Switch Closed

(3) Select Standard

The standard of statistics measurement defaults to the last record of basic record. If need to select other records as the standard, click “Select Standard” and click arrow to turn the page.

Eg: Click “Search”, users can search the record by “Search Index” and “Search Name”. Click the searched record to choose it as an entering standard.

Basic Record				
T005			16:35	2015.10.23
		20°	60°	85°
T001	T102316	22.5	21.5	21.3
T002	T102316	23.8	24.8	26.6
T003	T102316	33.3	31.5	32.7
T004	T102316	45.5	42.9	42.1
T005	T102316	60.5	66.3	63.9
Search		↑	↓	Back

Figure 34 Multi-angle Standard Entering (此处图片更换)

(4) Input Standard

Input a new basic record data as the standard of statistical mode. This new record will be automatically saved in basic record database.

Click “Input Standard” as shown in figure 35. In the interface “Check Basic Record”, if you select single angle mode, you can only input the corresponding single angle standard. If you select multi-angle mode, you can input the multi-angle standard in order. Then click “OK” to edit name as shown in figure 23.

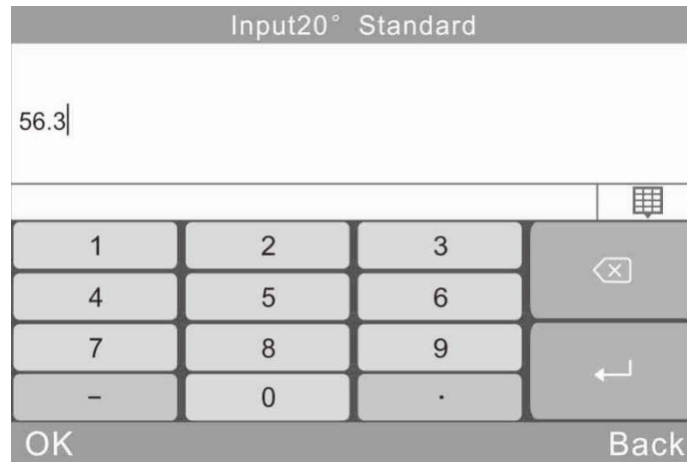

Figure 35 Input Standard

3.3.3 Continuous Mode Parameter

There are two functions: **Measurement Times** and Interval Time, shown in figure 36 and 37.

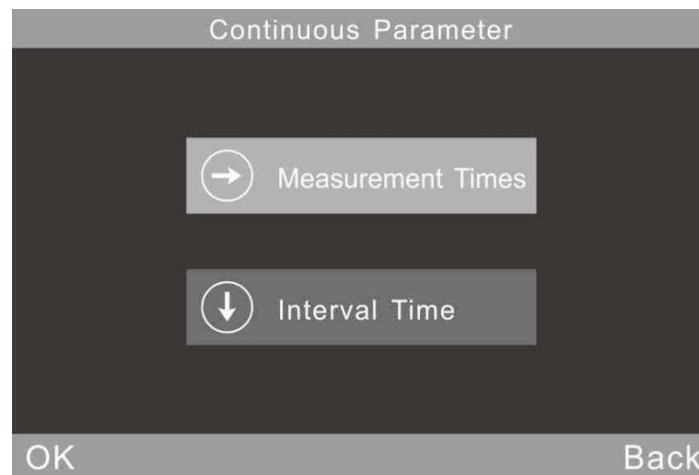

Figure 36 Sub-menu of Continuous Mode Parameter

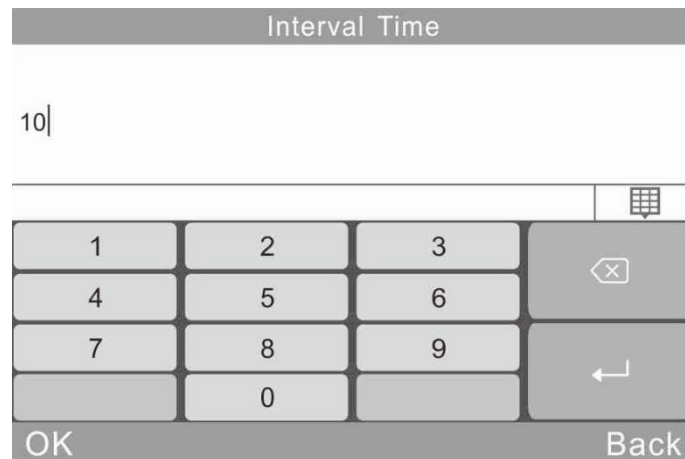

Figure 37 Interval Time Setting in Continuous Mode

3.4 Angle Selection

Click “Angle” to choose measurement angles according to requirements, shown in figure 7.

3.5 Tolerance Setting

Click “Tolerance”, shown in figure 38. Tolerance data is the standard of judgment to compare difference between statistical record and standard record. If the difference is within the tolerance range, the sample is qualified. Otherwise, the sample is unqualified.



Figure 38 Tolerance Setting

3.6 Function Setting

Click “Setting” to set other functions as shown in figure 39. Function setting includes “Auto save”, “Time Setting”, “Language Setting”, “Backlight Time”, “Operation Habit”, “Screen Brightness”, “Buzzer Switch”, “Restore Factory” (增加操作习惯，并注意所以引号方向)

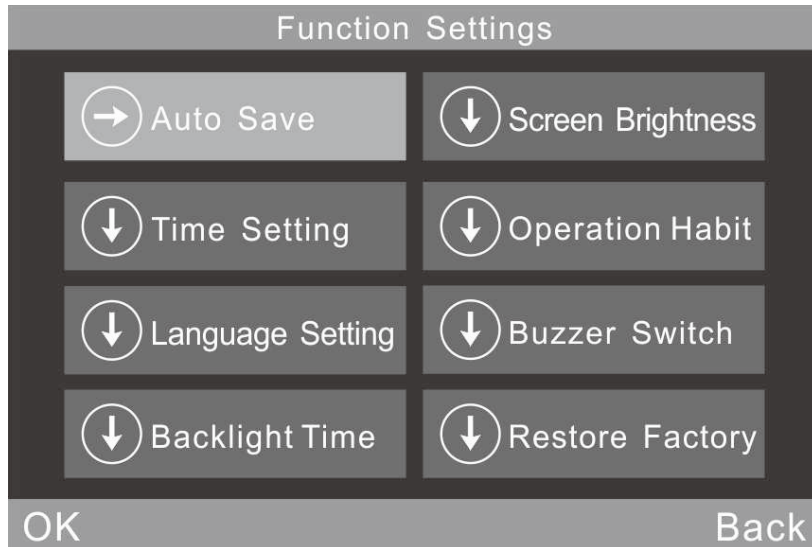

Figure 39 Function Setting (此处更换图片)

3.6.1 Auto Save

Click "Auto Save". It has two options: "On" and "Off". If select "Off", you have to save the data manually when measuring. If select "on", the instrument will save data automatically.

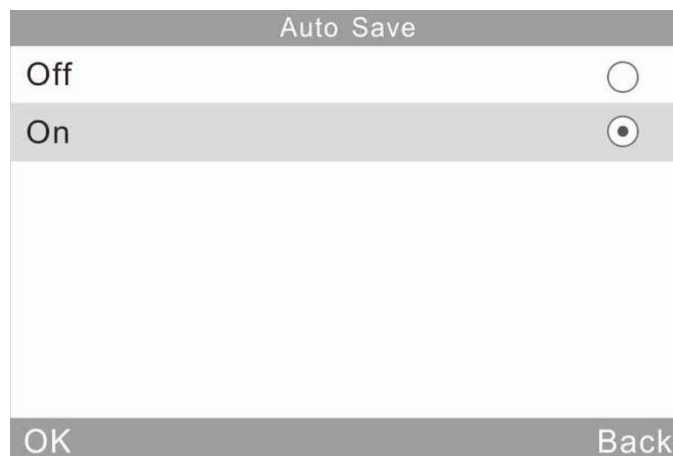

Figure40 Auto Save

3.6.2 Time Setting

Click "Time Setting" to set time and date, shown in figure 41.

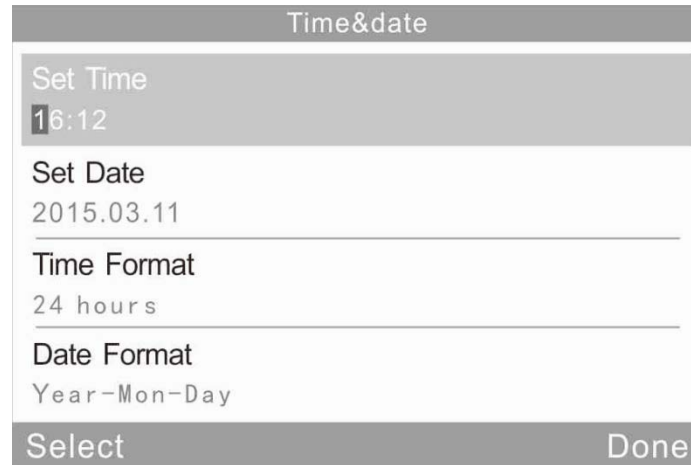

Figure 41 Time Setting

3.6.3 Language Setting

Click “Language Setting” to set English or Chinese.



Figure 42 Language Setting

3.6.4 Backlight Time

Click “Backlight Time” to set the backlight time according to the requirements

Remarks: The instrument will turn off after one minute when the backlight goes out.

3.6.5 Screen Brightness

Click “Screen Brightness” to adjust the brightness by “+” and “-”.

3.6.6 Operation Habit

Click “Operation Habit”. If you want to use the instrument by right hand, you can choose “Right”. If want to use the instrument by left hand, then you can choose “Left”.

3.6.7 Buzzer Switch

Click “Buzzer Switch” in “Settings”. When click “Off”, it will not make a sound when measuring. When click “on”, it will make a sound when measuring.

3.6.8 Restore Factory

Click “Restore Factory” in “Settings”, there will pop up a warning interface as shown in figure 43. Click “OK”, the instrument will restore factory settings and all records will be cleared.

Note: When set it, there will be a warning. Please operate it carefully! If you don't want to restore factory settings, please **click “Back”**.



Figure 43 Restore Factory Settings

4 Routine Maintenance

- (1) The gloss meter is a precise instrument. Please operate and store it in standard laboratory environment (Temperature: 20°C, Standard atmospheric pressure, Humidity: 50~70%RH). Please avoid to use it in humid environment, strong electromagnetic interface environment, high light intensity environment and dusty environment.
- (2) Standard plate is a precise optical component. Avoid being damaged by sharp object, avoid dirtying the **board and** avoid exposing it to sun. Regularly clean the standard plate by using soft cloth with alcohol in one direction. Ensure there are no tiny particles or sundries on the soft cloth. Before calibrating, clean the standard plate to make accurate calibration.
Attention: Forbid to use acetone solvent!
- (3) In order to ensure the accuracy of the instrument, it is better send it back to the factory or qualified Local National Institute of Metrology for calibration. (Once a year)
- (4) It needs to modify calibration value when the calibration value is different from practical measurement value. View chapter 2.2.2 for details.
- (5) The gloss meter is powered by built-in battery. When long time not using

this instrument, please charge it biweekly in order to protect the battery and extend the battery life.

- (6) The internal clean work of the instrument should be finished by manufacturer (suggest once a year). Do not use cleaning tools to clean the internal instrument. Otherwise it will cause irreversible damage.

5. Technical Specifications

Measurement Angle	20°/60°/85°/20°60°85°		
Standard	ISO 2813, GB/T 9754, ASTM D 523, ASTM D 2457		
Measuring Area(mm)	20°: 10x10, 60°: 9x15 (small aperture: 1.5x2), 85°: 5x36		
Measuring Range	20°: 0-2000GU, 60°: 0~1000GU, 85°: 0~160GU		
Division Value	0.1 GU		
Range	0-10GU	10-100GU	100-2000GU
Repeatability	±0.1GU	±0.2GU	±0.2%GU
Reproducibility	±0.2GU	±0.5GU	±0.5%GU
Chromaticity Corresponding	Corresponding with CIE 1931(2°) under CIE C light source		
Measuring Time	0.5 second		
Dimension	L*W*H : 160mm*75mm*90mm		
Weight	350g		
Battery	3200mAh Li-ion Battery, >10000 times(within 8 hours)		
Display	TFT 3.5inch, touch screen, resolution: 320*480		
Interface	USB/RS-232		
Storage	Basic mode: 1000, Statistical Mode:5000, Continuous Mode: 5000		
Software	GQC6 Quality Control Software with QC report printing function and more extended functions.		
Operation Temperature	0~40°C (32~104°F)		
Storage Temperature	-20~50°C (-4~122°F)		
Humidity	<85% relative humidity, no condensation		
Standard Accessories:	Power Adapter, USB cable, User Manual, CD (Including QC software), Wiping Cloth, Calibration Plate		
Optional Accessories:	Miniature Printer		
Note	The specifications are subject to change without notice.		