

PCE Americas Inc.
711 Commerce Way
Suite 8
Jupiter
FL-33458
USA
From outside US: +1
Tel: (561) 320-9162
Fax: (561) 320-9176
info@pce-americas.com

PCE Instruments UK Ltd.
Units 12/13
Southpoint Business Park
Ensign way
Hampshire / Southampton
United Kingdom, SO31 4RF
From outside UK: +44
Tel: (0) 2380 98703 0
Fax: (0) 2380 98703 9
info@pce-instruments.com

www.pce-instruments.com/english
www.pce-instruments.com

USER MANUAL Laboratory Balances PCE-SD Series



1. General description

SD series platform scales are destined for general use.

All scales are metrologically tested - calibration or legal verification on demand.
SD series scales are made in two main versions: with LED display (basic) and with LCD display (option).

Scales have following verification features:

- a seal protecting scale casing against opening,
- notified body stamps and green metrological marking placed on the balance name plate.

Legal verification is valid for 3 years unless the seal is broken.

NACE classification: 29.24.23.

Certificates:



Certificate of type
approval no. T7950

2. Completeness









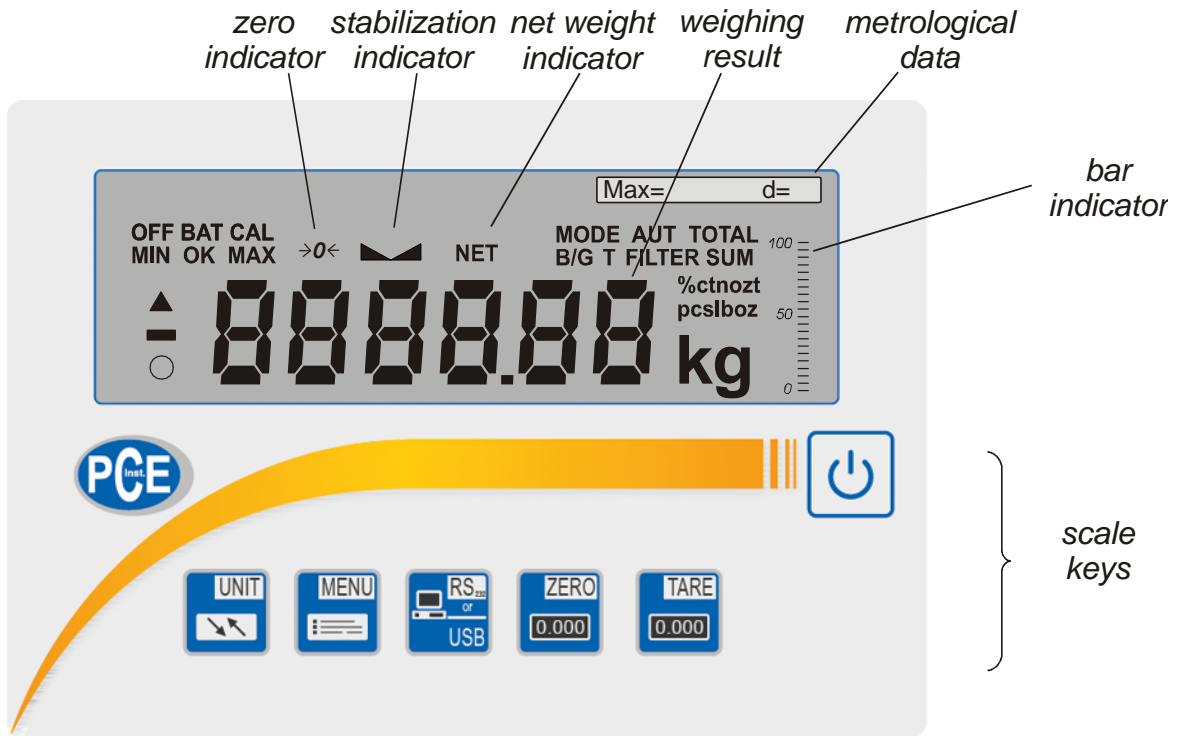

Standard set consist of:

1. Indicator
2. Column with 3 pcs screws
3. Platform
4. Feeder
5. User Manual
6. Guarantee card

3. Keys and indicators







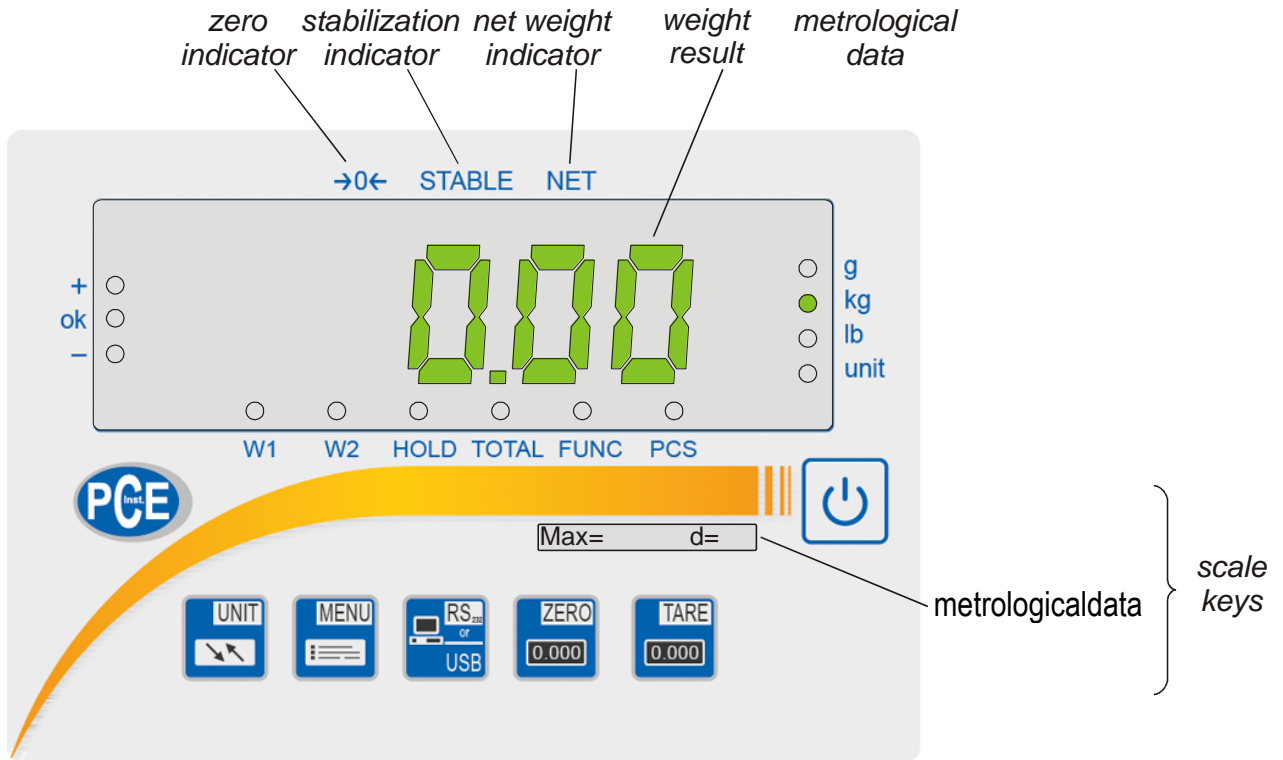

LCD display version:



- | | | |
|---------------|---|---|
| Keys: |  | - switch-on / switch-off (standby), |
| " |  | - tare (subtract package weight from weighed mass), |
| " |  | - zeroing (when the platform is empty), |
| " |  | - result printout, |
| " |  | - menu, |
| " |  | - function switch: net weight / gross weight |
| Indicators: | $\rightarrow 0 \leftarrow$ | - zero indicator (unloaded scale), |
| " |  | - result stabilization indicator, |
| " | NET | - net weight (after using  key), |
| " | MODE | - special function menu turning on indicator |
| " | B/G | - gross weight (after using TARE and  key) |
| " | AUT | - autotare function on, |
| " | T | - tare memory function on, |
| " | TOTAL, FILTER, SUM | - special functions indicators, |
| " | % , ct , n , g/m2 , lb , mg | - unit indicators, |
| " | pcs | - pieces counting indicator, |
| " | n | - measurements quantity indicator (total function), |
| " | OFF | - scale turned off  (standby) |
| " | MIN | - weighing result under threshold I (<i>thr</i> function), |
| " | OK | - weighing result between threshold I and II, |
| " | MAX | - weighing result above threshold II, |
| " | BAT | - battery discharge indicator, |
| " | Δ , O | - ACt/V function indicator, |
| bar indicator | | - scale load indicator (0-100%) |

LED display version:



- Keys:**
- "  - switch-on / switch-off (standby),
 - "  - tare (subtract package weight from weighed mass),
 - "  - zeroing (when the platform is empty),
 - "  - result printout,
 - "  - menu,
 - "  - function switch: special function/weighing,
- Indicators:**
- " $\rightarrow 0 \leftarrow$ - zero indicator (unloaded scale),
 - "  - result stabilization indicator,
 - " NET - net weight (after using  key),
 - " W1 - first range on in two-range scale,
 - " W2 - second range on in two-range scale,
 - " HOLD - indication „locked” (concerns LOC and UP functions),
 - " FUNC - special function turned on,
 - " PCS - pieces counting,
 - " g, kg, lb, unit - weight unit (g-gram, kg-kilogram, lb-pound, unit – other),
 - " MIN - weighing result under threshold I (*thr* function),
 - " OK - weighing result between threshold I and II,
 - " MAX - weighing result above threshold II,

During inscribing numerical values needed during using special functions keys have special functions.

4. Scale external outputs

Meter in aluminium housing:

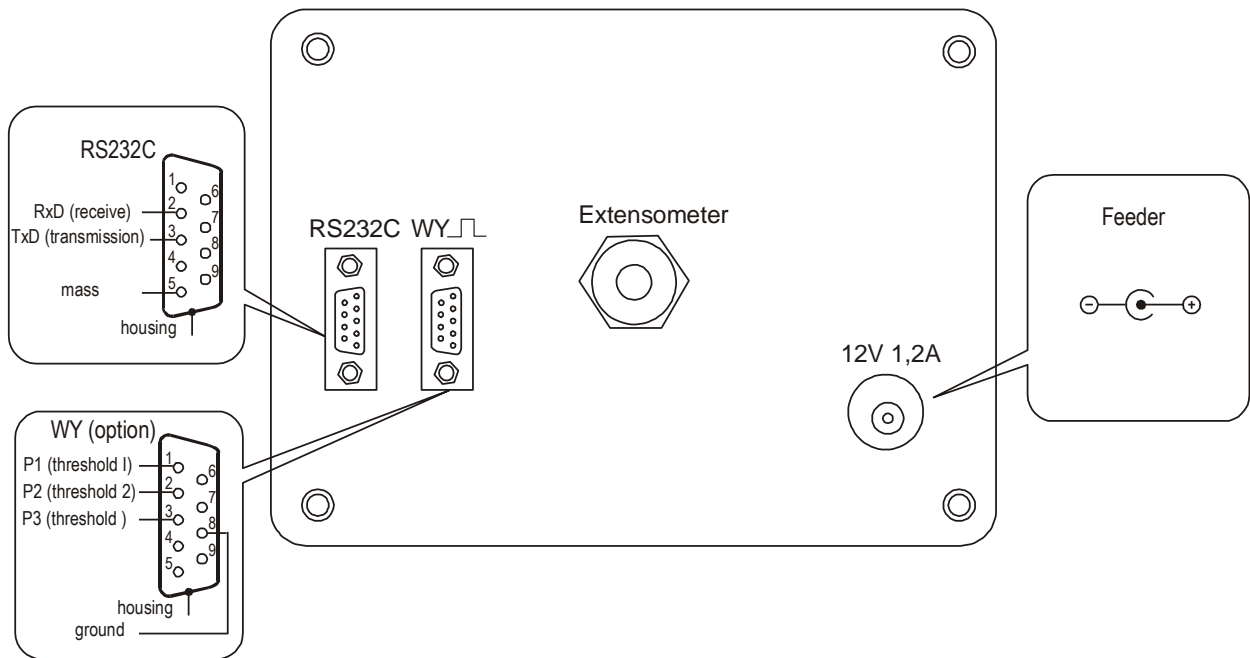

Meter in stainless steel housing:

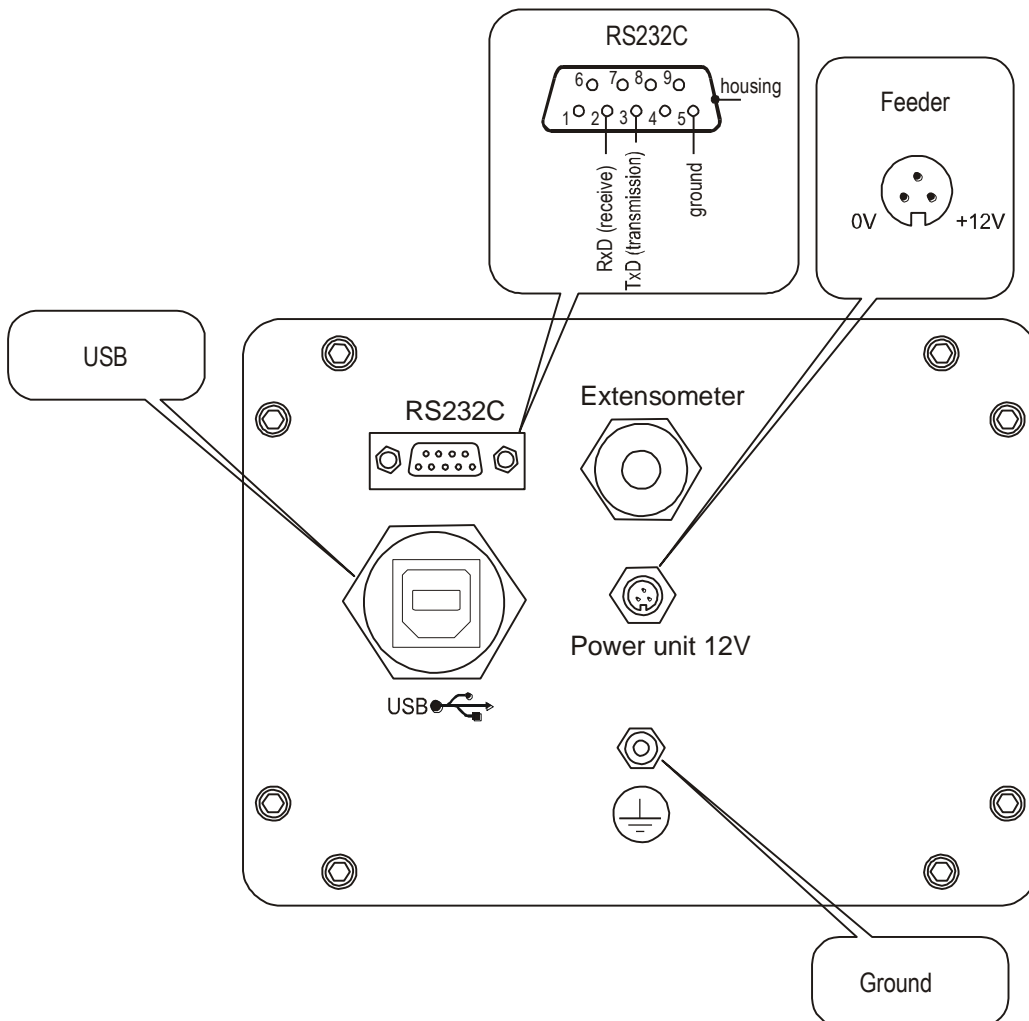

Separate ground connection (scales in stainless steel version) must be connected using additional conductor.

Extensometers are connected permanently.

5. Security rules

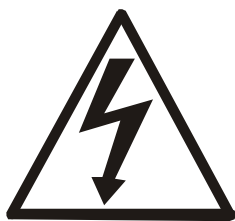

To avoid electrical shock or damage of the scale or connected peripheral devices, it is necessary to follow the security rules below.

- All repairs and necessary regulations can be made by authorised personnel only.
- To avoid fire risk use a feeder of an appropriate type (supplied with the scale). Pay attention that supply voltage is compatible with specified technical data.
- Do not use the scale when its cover is opened.
- Do not use the scale in explosive conditions.
- Do not use the scale in high humidity.
- If the scale seems not to operate properly, unplug it from the mains and do not use until checked by authorised service.



According to legal regulations it is forbidden to dispose of wasted electronic equipment in waste containers.

- Please return wasted scale to the point of purchase or other company specialised in recycling of wasted electronic components.

6. Preparation

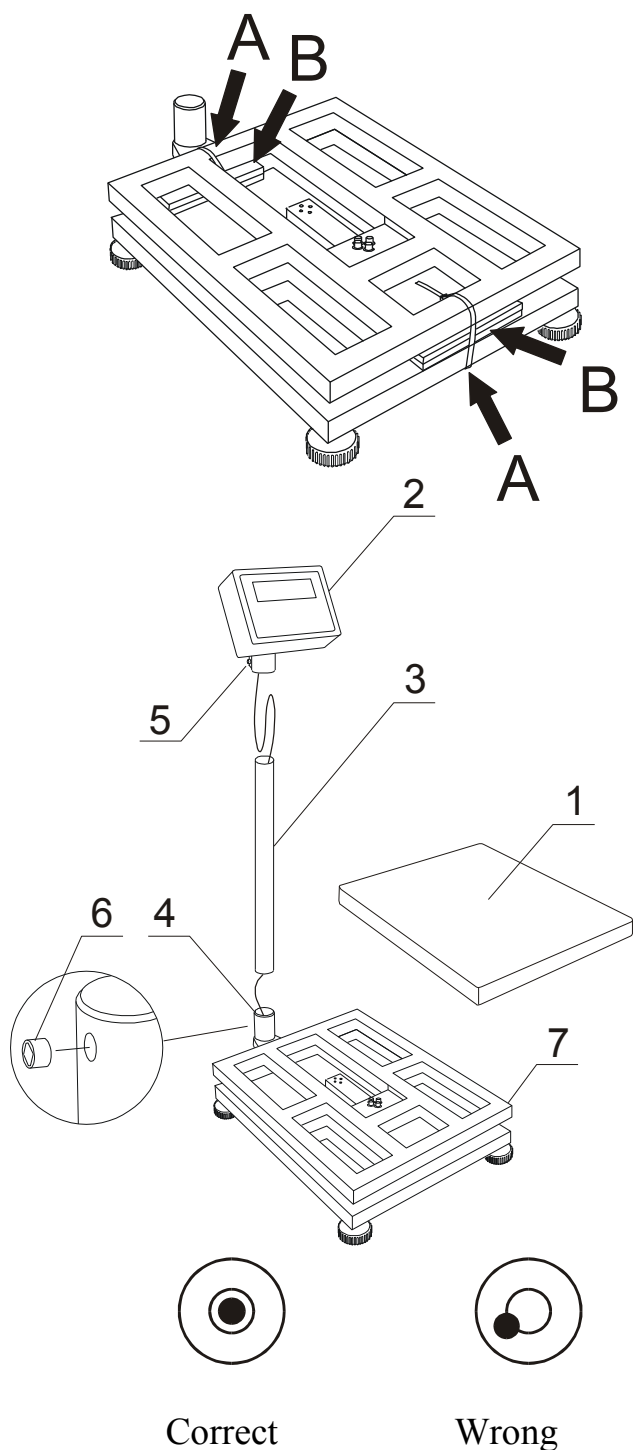

1. Take the scale out of the package removing protective foils.
2. Take out the pan 1.
3. Cut bands A and remove protection elements B.

Attention: Protections elements not allowed scale work properly.

4. Hold bought indicator 2 and column 3, softly pulling connecting cable.
5. Put a column 3 to holder 4.
6. Lay junction cable to manner showed on drawing and put cable to interior of column. Put indicator 2 on column 3 and tighten screw 5.
7. Catch scale platform 7, and take out scale from package carefully.



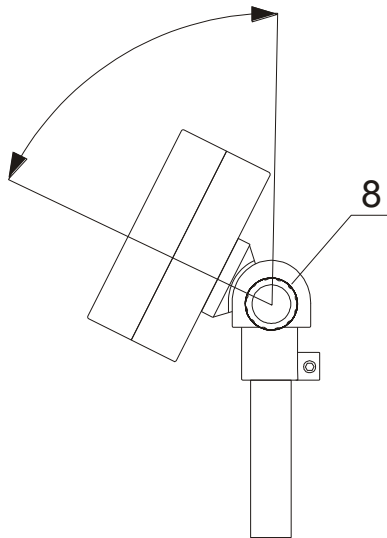

Attention: Unfixed column 3 can be drop from holder 4.

8. Use hex key to drive three screws 6 in to holes on holder 4 for standstill column.
9. Place the scale on a stable ground not affected by mechanical vibrations and airflows.
10. Level the scale with the rotating rear legs so that the air bubble in the water-level at the back of the scale is in the middle. Lock the legs with the nut.
11. Put the pan 1 on the platform 7.



12. Remove screw 8 and adjust correct angle to read scale indications. Lock indicator - screw 8.

7. General rules

1. Before each measurement make sure that zero indicator is displayed. If zero indicator does not displayed or “----“ communicate appears, press  key and wait until zero indication and zero indicator appears.
2. The scale is equipped with a tare equal to its range. To tare the scale press  key (left or right). Storing a tare value does not extend measuring range, but only subtracts it from a load placed on a pan. To make weight control easier and to avoid range overdrawn, the scale is equipped with a load indicator (graduated in percentages).
3. Weighing result should be read when the indicator "▲▲" lights, which signalises stabilisation of a result.
4. When the scale is not used but it is necessary to be ready to work immediately, it can be switched off by pressing  key. The scale reading system is then switched off to "standby" mode (signalled by the indicator "OFF" in version with the LCD display). To switch the scale on press  key. The scale is immediately ready to operate maximum accuracy (after self tests).
5. Weighed sample should be placed in the centre of the pan.



Place the scale on a platform to avoid dropping weighed objects on the pan.



Do not overload the scale more than 20% of maximum load (Max).

6. Protect the scale against dust, aggressive dusts and liquids. To clean the scale wash it with water with soap and dry it afterwards.
7. A scale equipped with lead-acid accumulator automatically controls accumulator state, signalises its discharge on LCD display and after around 1h a scale switches itself off to avoid discharging the accumulator below threshold voltage.



Do not discharge an accumulator because it can be damaged.

After discharge signalising appears an accumulator should be charged as quickly as possible by connecting external feeder. Charging is more effective when scale is turned off with  key, then charging time is about 10 hours.

It is also possible to connect accumulator directly to PA6V charger leaving accumulator in a scale or take it out if needed. In order to take accumulator out take off a pan, disconnect accumulator wire and unscrew mounting screws.

8. Balance checking

It is advised to check scale indication accuracy before and after series of measurement using any load with known weight.

To check the scale with legal verification use a calibration weight with valid calibration certificate. In case permissible error is exceeded it is advised to contact the nearest service to calibrate the scale.

9. Scale adjustment



To adjust a balance it is necessary to break protective marks, therefore to calibrate the scale please contact the nearest service.

10. Accumulator change (option)

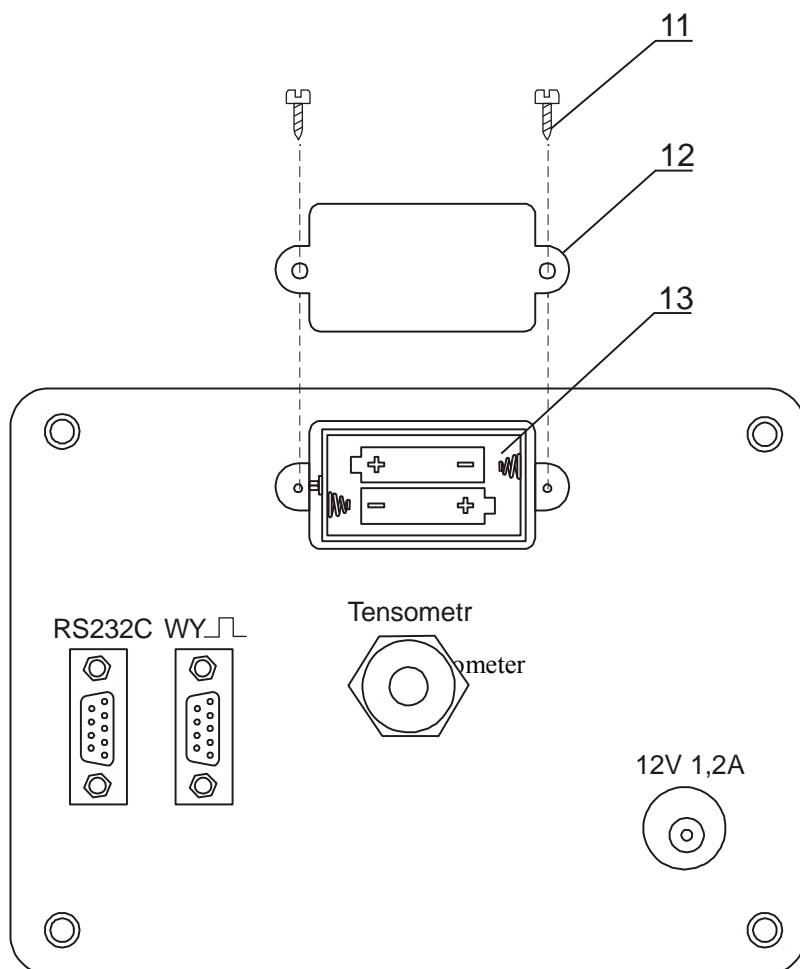

1. Remove screws 11 holding plate 12, remove the plate.

Take out container with accumulators 13 and place 4 AA format accumulators.

The way of packing accumulators into the container is shown on the figure on the left and is also shown on the container.

11. Connecting a computer, printer or lable printer

The scale is equipped with RS232C, which can be used to connect external devices such as computer or a printer.

When cooperating with computer, the scale sends weighing result after initialize signal from computer or after pressing  key on the scale.

When cooperating with a printer data is send automatically after result stabilisation, but next transmission is possible after removing previously weighted sample.

When cooperating with label printer after pressing  key, the scale sends instructions set for the label printer. Label number 0001, hour, data (if the clock is installed and on) and nett weight. During transmission *LabEL* communicate is displayed.

The way of sending data and transmission parameters is set using *SERIAL* special function.

Set of send data is set using special function *PrInt*.

The following data can be send:

- Header (scale type, Max, d, e, serial number),
- Operator identification number,
- Successive printout number (measurement),
- Identification number or product bar code,
- Number of pcs (PCS function only),
- Single detail mass (PCS function only),
- Net weight,
- Tare (package mass),
- Gross weight,
- Total mass (Total function only).

If the scale is equipped with two serial joints *Print* function is set independently for both interfaces.

Computer must have a special program for cooperation with data from a scale.

Except RS232C joint, the scale can be equipped with USB interface.

11.1 Detailed LonG protocol description

Communication parameters: 8 bits, 1 stop bit, no parity, baud rate 4800bps ,

- initialising signal (data send order) – correspond to press  key
 Computer→Scale: **S I** CR LF (53h 49h 0Dh 0Ah),
 Scale→Computer: scale response according to description below (16 bytes):

Byte	1	-	sign „-“ or space
Byte	2	-	space
Byte	3÷4	-	digit or space
Byte	5÷9	-	digit, decimal point or space
Byte	10	-	digit
Byte	11	-	space
Byte	12	-	k, l, c, p or space
Byte	13	-	g, b, t, c or %
Byte	14	-	space
Byte	15	-	CR
Byte	16	-	LF

Attention:

Network number different than zero (*SErIAL / nr* function) changes scale working mode: communication with a computer is possible after logging the scale in with 02h scale number command. To log the scale out use 03h command.

- Asking about scale presence in system (testing scale connection with computer):
 Computer→Scale: **S J** CR LF (53h 4Ah 0Dh 0Ah),
 Scale→Computer: **M J** CR LF (4Dh 4Ah 0Dh 0Ah),
- Displaying a inscription on scale's display (text communicate from computer):
 Computer→Scale: **S N n n X X X X X X** CR LF, nn-displaying time in seconds; XXXXXX-6 signs to display
 Scale→Computer: **M N** CR LF (4Dh 4Eh 0Dh 0Ah),
- Scale tarring (calling →**T**← key press) :
 Computer→Scale: **S T** CR LF (53h 54h 0Dh 0Ah),
 Scale→Computer: without response,
- Scale zeroing (calling →**0**← key press):
 Computer→ Scale: **S Z** CR LF (53h 5Ah 0Dh 0Ah),
 Scale →Computer: without response,
- Scale turning on / off (calling **I/** key press):
 Computer→ Scale: **S S** CR LF (53h 53h 0Dh 0Ah),
 Scale →Computer: without response,
- Entering to special function menu (calling **MENU** key press):
 Computer→ Scale: **S F** CR LF (53h 46h 0Dh 0Ah),
 Scale →Computer: without response,

- Setting threshold 1 value (option):
 Computer → Scale: **S L D1...DN CR LF** (53h 4Ch D1...DN 0Dh 0Ah)
 D1...DN – threshold value, maximum 8 characters („-“ – negative value, digits, dot – decimal separator), number of digits after dot should be the same as on scale display,
 Scale → Computer: without response,
 Example:
 · in order to set low threshold 1000g in scale B1.5 (d=0.5g) the following order should be sent:
 S L 1 0 0 0 . 0 CR LF (53h 4Ch 31h 30h 30h 30h 2Eh 30h 0Dh 0Ah),
 · in order to set low threshold 100kg in scale B150 (d=50g) the following order should be sent:
 S L 1 0 0 . 0 0 CR LF (53h 4Ch 31h 30h 30h 2Eh 30h 30h 0Dh 0Ah),,
- Setting threshold 2 value (option):
 Computer → Scale: **S H D1...DN CR LF** (53h 48h D1...DN 0Dh 0Ah),
 D1...DN – threshold value, maximum 8 characters
 Scale → Computer: without response.
- Setting threshold 3 value (option):
 Computer → Scale: **S M D1...DN CR LF** (53h 4Dh D1...DN 0Dh 0Ah),
 D1...DN – threshold value, maximum 8 characters
 Scale → Computer: without response.

Connecting cable WK-1 (scale – computer / 9-pin interface):

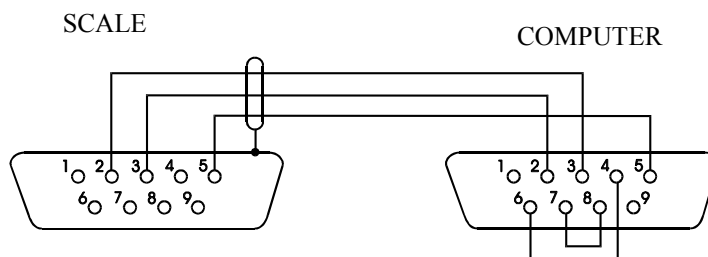

Connection cable WD-1 (connects scale with PCE-BP 1 printer):

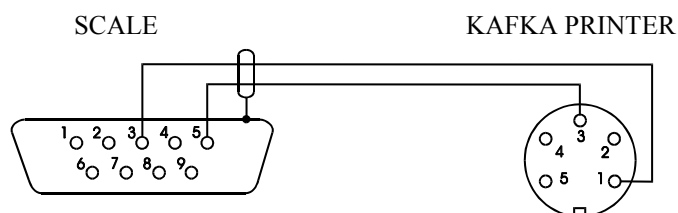

Setting of internal swithes of PCE-BP 1 printer:

SW-1	SW-2	SW-3	SW-4	SW-5	SW-6	SW-7	SW-8
on	off	on	off	off	on	off	off

11.2 Detailed EPL protocol description

Transmission parameters: 8 bits, 1 stop bit, no parity, baud rate 9600bps,

- After using  key in scale:
- Scale→Label printer : set of instruction in EPL-2 language that initialize label printing:

US	- Steering instruction
FR"0001"	- Label number define instruction
?	- Instruction that starts list of variable signs
mm:gg	- 5 signs: minutes:hour
rrrr.mm.dd	- 10 signs: year.month.day
masa	- 10 signs: scale indication+ mass unit
P1	- Steering instruction

Attention:

- a. Except variable signs constant signs can also be inscribed e.g. factory name, product name and so on.
- b. In standard only one label pattern is possible to printout (number 0001). Using bigger amount of patterns (other label numbers) is possible thanks to *LABEL* special function.
- c. To achieve label printout, label printer must have inscribed label pattern (label pattern is created on computer and using computer it is saved to label printer memory). Label pattern is designed by ZEBRA DESIGNER program which is supplied together with label printer.
- d. Scales parameters and transmission protocol must correspond to label printer type.

12. Start-up

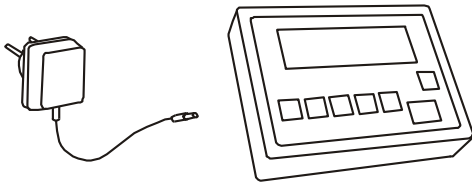

Leave the pan empty, plug a scale to the mains with a ground contact. The scale proceeds with following start-up actions:

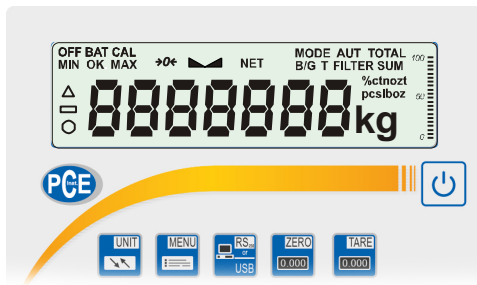

Display test

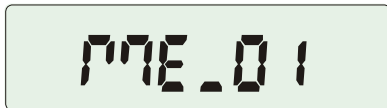

Meter type displaying



Program version



The scale is now ready to work.

Attention:

Displaying program version means positive result of all tests.

13. Weighing with tare

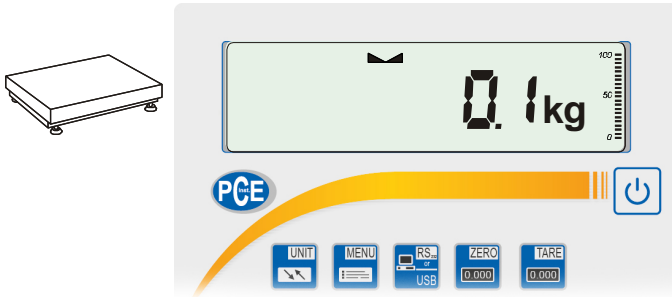

If the scale is not loaded and $\rightarrow 0 \leftarrow$ indicator doesn't indicate, press  key.



Zero indication and $\rightarrow 0 \leftarrow$ indicator mean that the scale is ready to work.





After putting container (package) tare the scale using  key. NET indicator will show up.



Put on weighted object and readout net weight (NET indicator shows that scale indicates net weight).



In order to readout gross weight press  key (B/G indicator shows that scale indicates gross weight). Press again  key in order to come back to net indications.



14. Scale menu

All scales except for basic metrological functions: weighing and taring, have many special functions and configuration options.



In order to ease using functions user can create his own (personalized) menu.

Creating personalized menu:

In „out of the box” scale after pressing *MENU* key only *SETuP* option (it contains all configuration options) is available.



One of the configuration options is *Menu* that is used to create personalized menu.



To add a function to personalized menu press  key when the function is indicating.

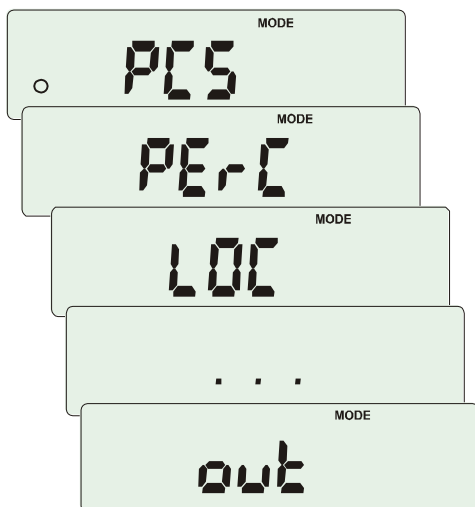

Chosen function is indicated with „o” sign on the left side of display.

After adding all necessary functions press *out* in order to come back to weighing mode. User now after pressing *MEnu* key has access to selected earlier functions and to *SETuP* option.

DEFAULT option is used to set factory settings.

15. Menu navigation rules



Choosing menu options:

Scale menu shows up after pressing *Menu* key. It is sequentially displayed in the form of abbreviations.

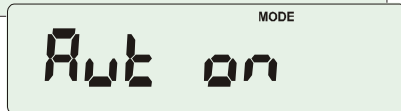
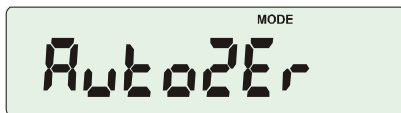

Choosing menu position (option) is done by pressing  key when it is displayed on the screen.

After choosing position (option) usually several options show up:

- on* – turning on selected option,
- OFF* - turning off,
- out* – out to menu.

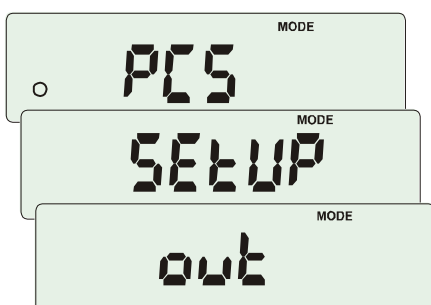
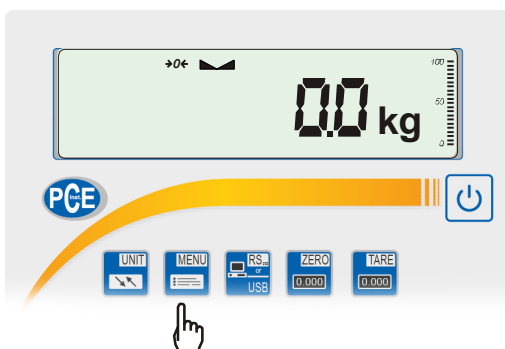

Accelerated working with menu:

Faster menu options moving is enabled by using  key.

Immediate out to previous menu level is done by using  key.

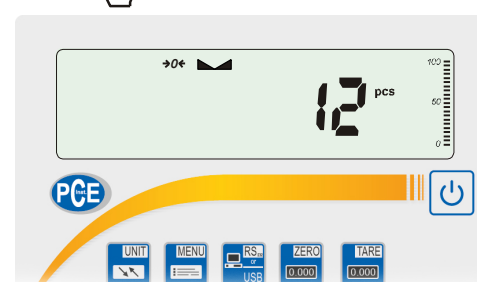
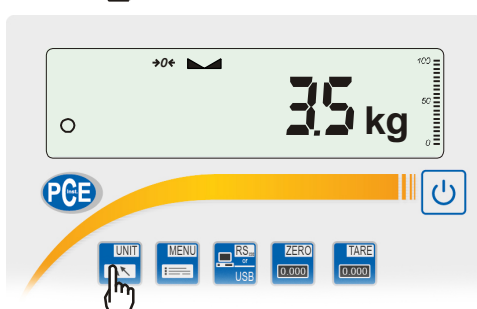
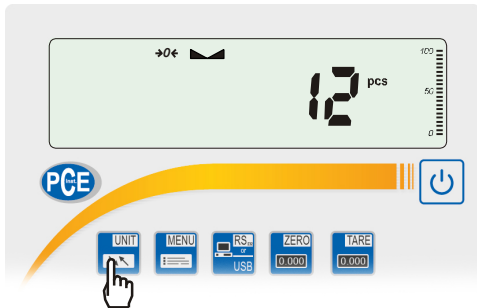
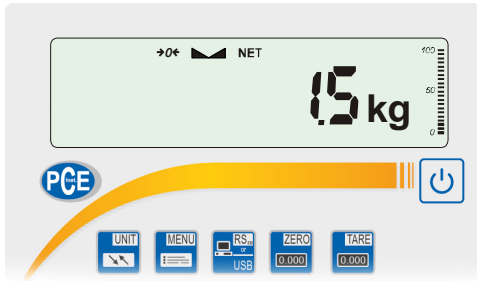
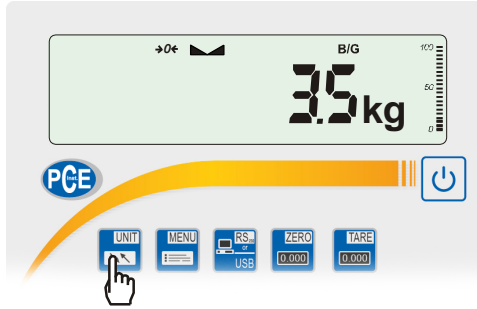
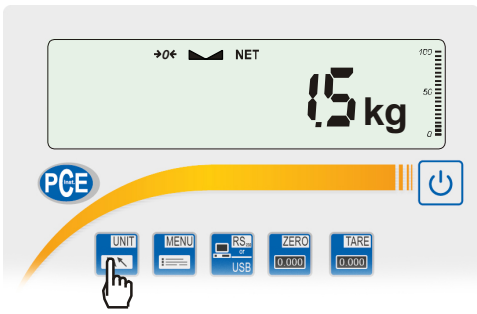

 key working method:

During standard weighing  key is used to switch between net and gross indication.

When special function e.g. PCS is turned on, using  key enables to go back to standard weighing mode.

Sign „o” on the left side signalsizes that special function is turned on and user can go back to function mode by pressing  key.

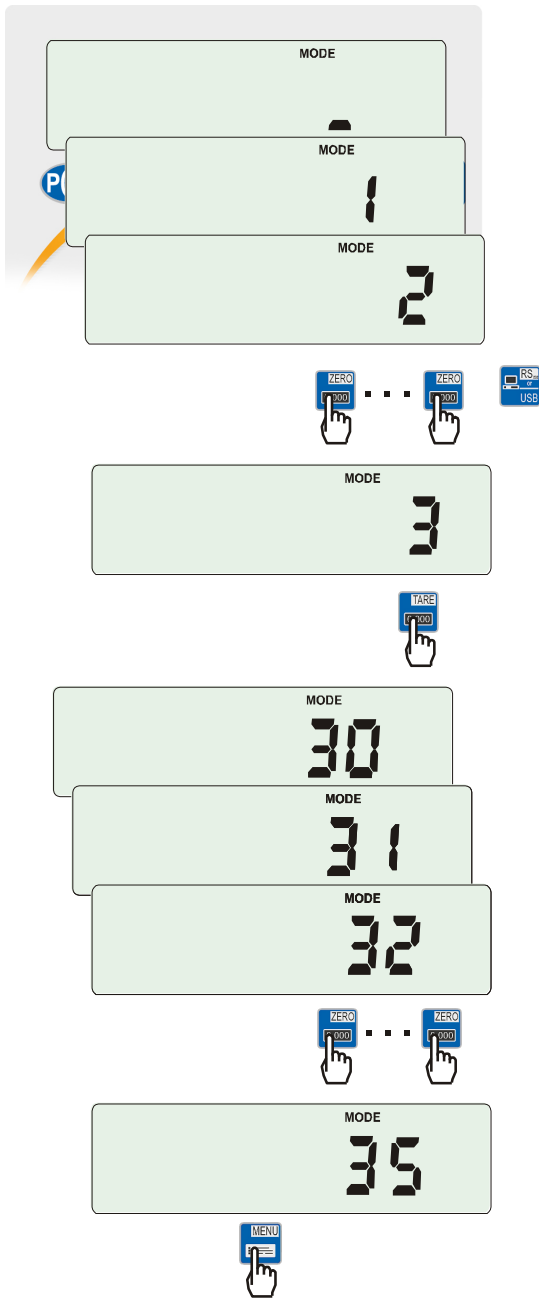

Inscribing numerical values:

Inscribing numerical values is needed in some special functions e.g. *tArE* function requires to inscribe tare values.

Keys:



- increasing digit value,
- decimal point,



- next digit position,



- end of inscribing.

USER MANUAL

Menu diagram:

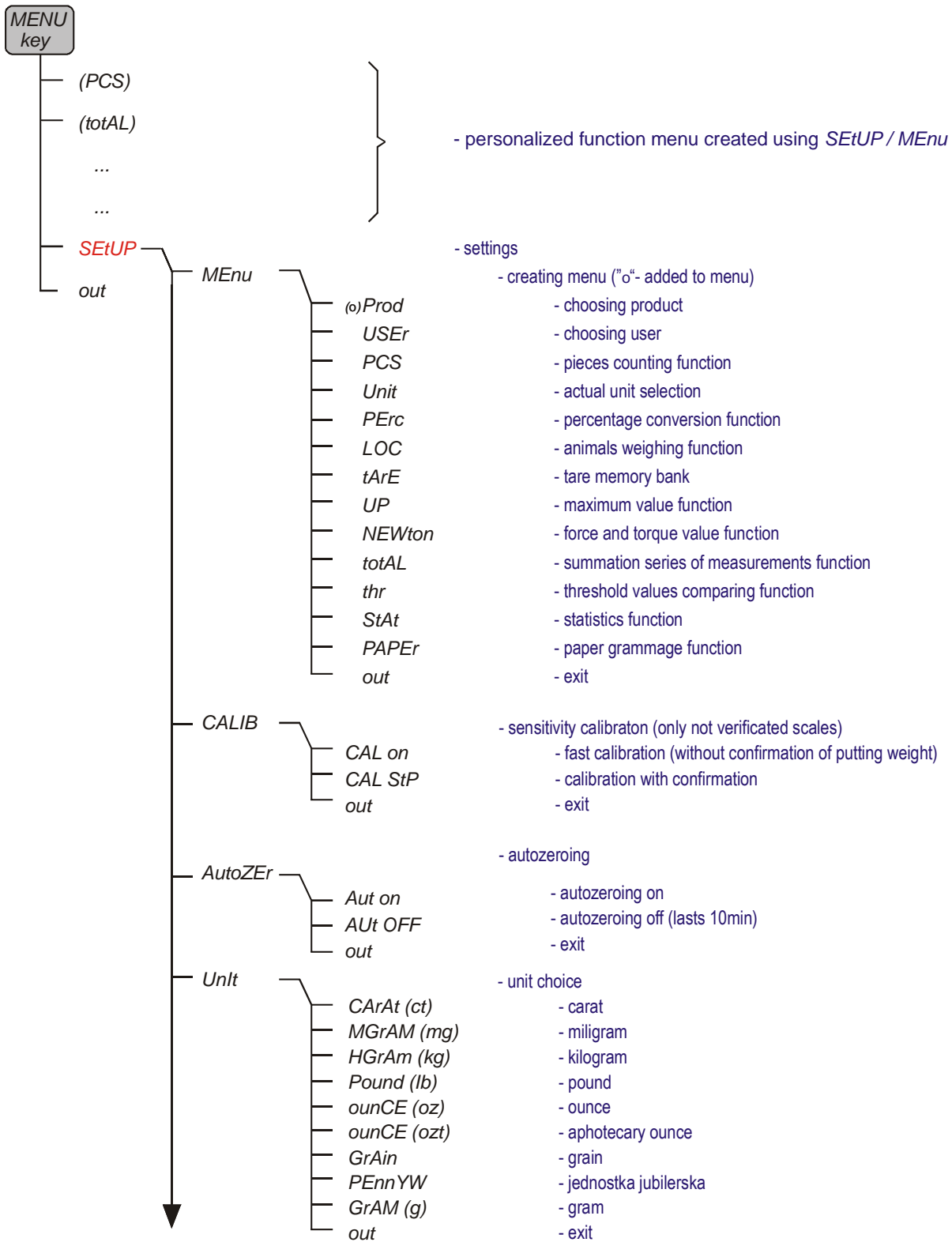

USER MANUAL

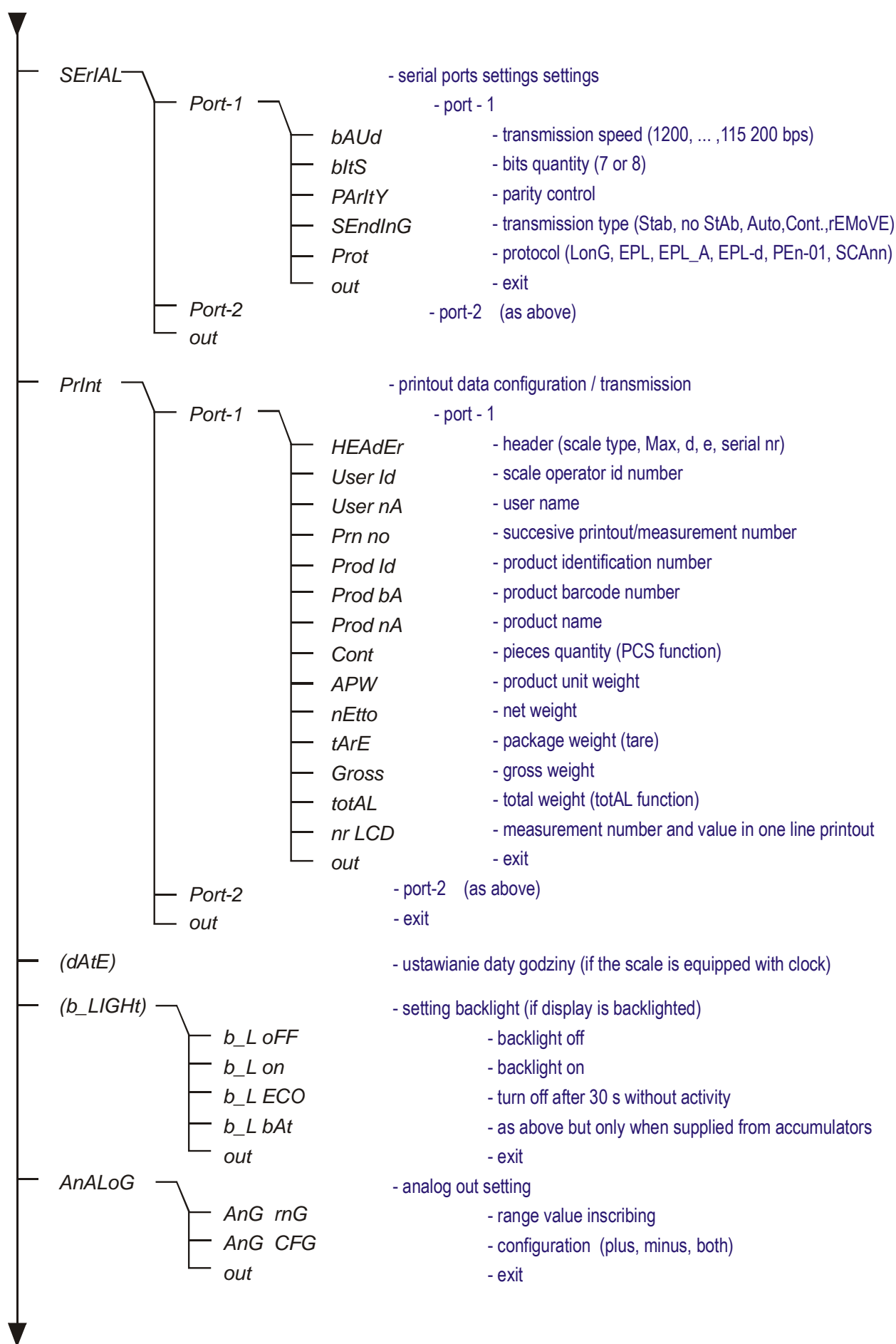

USER MANUAL

	<i>(bAttEry)</i>	- turn on/off accumulator charging (if the scale is equipped with accumulator)
	<i>(AUto OFF)</i>	- automatic turning off - saving accumulator power (as above)
	<i>(ZEro)</i>	- scale start zero inscribing (factory zero)
	<i>dEFAULT</i>	- restore default settings for all options
	<i>SErVICE</i>	- options only for service
	<i>out</i>	- exit

16. Scale setup (SEtUP)

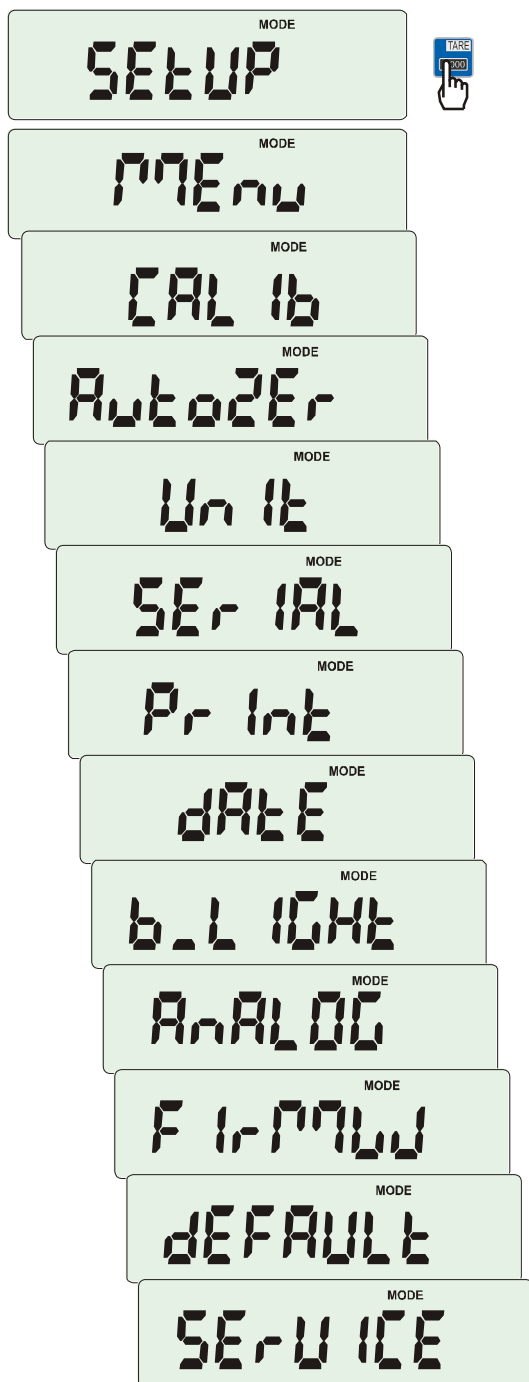
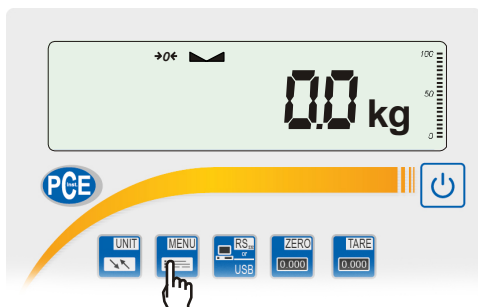

SEtUP contains all options used for setting scale work mode:

- MEnu – creating personalized user menu
- CAL Ib – scale sensitivity calibration
- AutoZEr(ing) – self-maintaining zero indication (unloaded scale)
- Un It – weight unit selection
- SEr IAL – setting serial ports
- Pr Int – transmission (printout) data selection
- FILT Er – anti-disturbance filter
- b_LIGHt – backlight setting
- Ad420 – analogue out configuration
- FirMw(are) – updating software (only for service)
- dEFAULT – reset to factory settings (sample of using in chapter 15)
- SErV ICE – service menu (only for service)

16.1 Scale calibration (CALib)

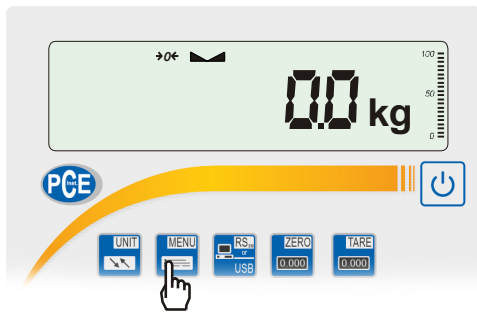

Press key.

Press key when CALib appears.

The following options will be displayed:

-CAL on – calibration with external recommended standard of mass (see technical data).

-CAL StP- calibration with external weight, confirmation of successive steps - key, out - leave without changes

Press key when CAL StP option appears (calibration in two steps).

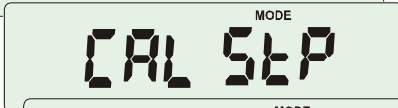
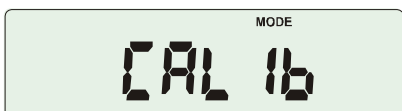

Press key when weight value used for calibration is indicating or use other option and inscribe proper value (keys , ,)

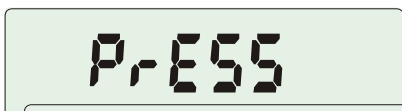
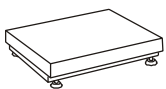

Press and wait for writing zero to the scale.

1000g

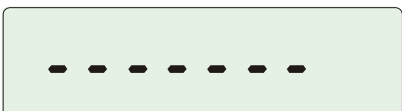
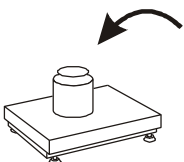

When LOAD message appears put standard of mass on the pan. Press key (CAL on doesn't need pressing key).

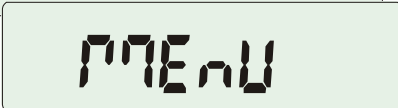

Wait until internal calibration is finished and zero indication is displayed.



16.2 Autozeroing function (AutoZEr)

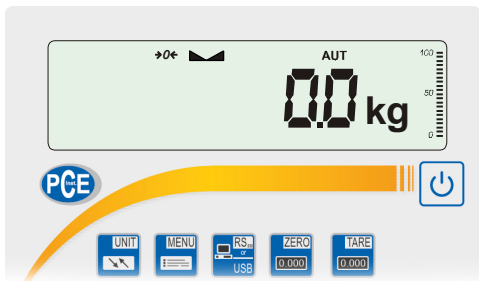
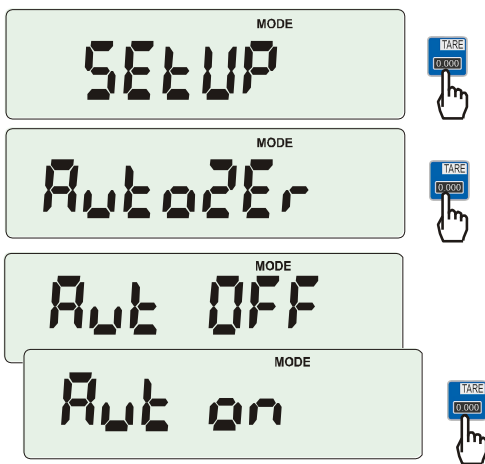
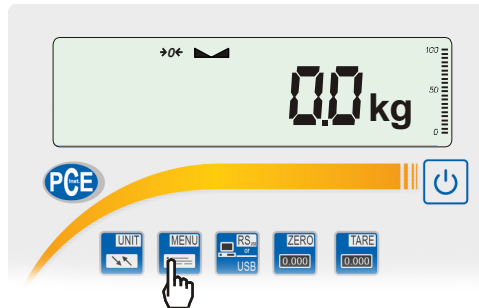

When the function is activated, the scale automatically ensures stable zero indication if the pan is empty or if zero indication was acquired by pressing **TARE 0.000** key.

To turn on the function use **TARE 0.000** key and using **TARE 0.000** key choose AutoZEr and then Aut on. To leave the function press **MENU** key, then with **TARE 0.000** key choose AutoZEr and Aut OFF.

Note:

1. Aut sign occurs only in scales with LCD display.
2. In scales with **ZERO 0.000** key active function changes name into AutoZE (autozeroing) and works only when the scale is unbaised.

16.3 Weight unit selection (Unit)

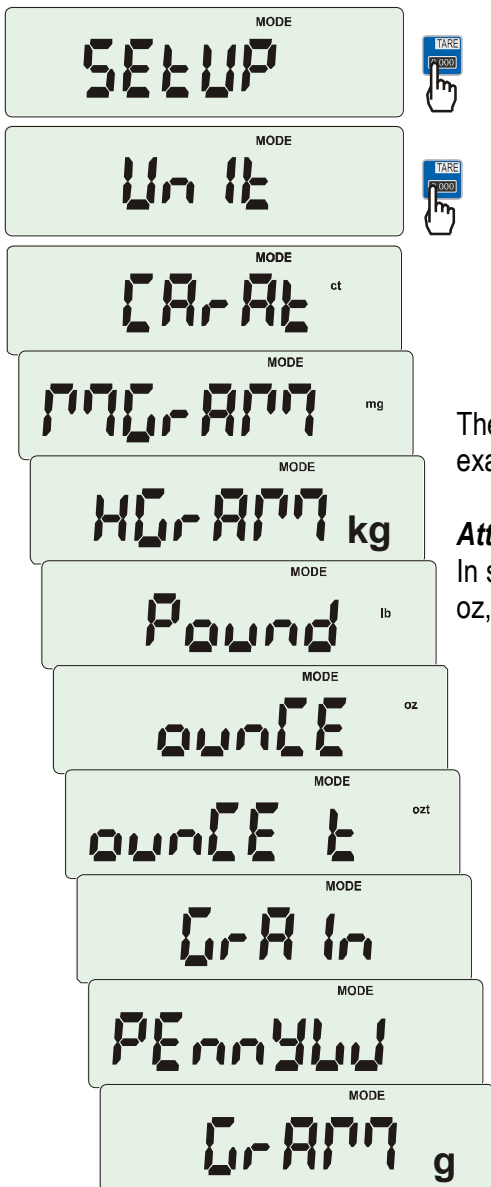
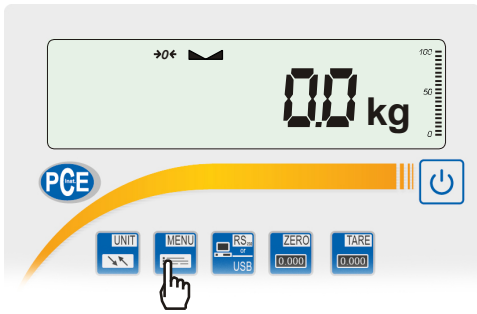

The function allows selecting weighing unit:

- CarAt (1 ct= 0,2 g) - carat,
- MGrAM (1mg=0,001g) milligram,
- KGrAM (1kg=1000g) kilogram,
- Pound (1 lb=453,592374g) English pound,
- OunCE (1oz=28,349523g) - ounce,
- OunCEt(1ozt=31,1034763g) pharmaceutical ounce,
- GrIn (1gr=0,06479891g) - grain
- PennYW (1dwt=1,55517384g) jewellery mass unit,
- GrAM (1g) - gram.

The way of choosing carats as weighing unit is shown on the example.



Attention:

In scale with LED display designations of mass units: lb, kg, oz, ozt, ct are not displayed. Units are pointed by diode light.

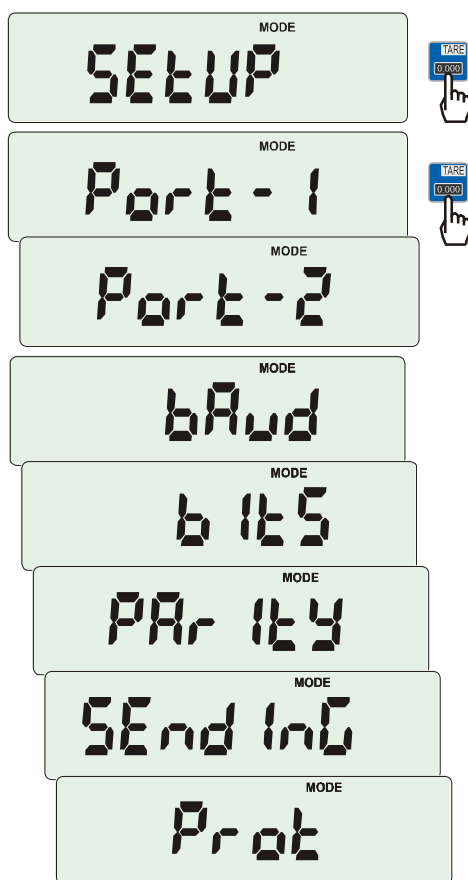
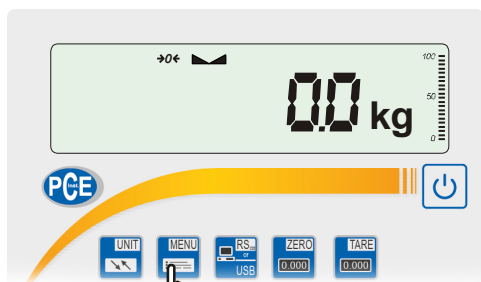
16.4 Serial port parameters setting (SERIAL)



The function allows setting independently communication parameters of both of serial ports *Port-1* and *Port-2* (executed in RS232C, RS485, USB or LAN standard):

- transfer protocol (*Prot*):
 - Long* – cooperation with printer or computer,
 - EPL* – cooperation with label printer in normal mode (activates *LABEL* function),
 - EPL_A* – cooperation with label printer in automatic mode (activates *LABEL* function),
 - EPL_d* – cooperation with special label printers,
 - Pen-01* – cooperation with PEN-01,
 - SCAnn* – cooperation with MJ-4209 barcode readers.
 - baud rate (*bAud*): (4800, 9600,115 200bps),
 - number of bits in single char. (*bits*): 7, 8,
 - parity control (*PARitY*):
 - nonE* – no control
 - Odd* –nonparity
 - Even* – parity control,
 - scale number in network (*nr*):
 - (if the scale doesn't work in network the number must be 0),
 - transmission through serial interface (*SendInG*) :
 - StAb* – transmission after  key is used and result is stable,
 - noStAb* – transmission after  key is pressed without need of stabilisation,
 - Auto* - automatic transmission after load is put on and result is stable (*Auto*),
 - Cont* - continuous transmission, about 10 results per second (*Cont.*),
 - Remove* - trans
- Default parameter values:
Long, 9600 bps, 8 bits, none, StAb

In order to set needed parameters choose *SERIAL* function, select appropriate parameter and press  key when required option or parameter value is displayed.

In scales with an additional serial port appear *Port-1* and *Port-2*, for the independent setting of both ports.

16.5 Printout configuration (PrInt)

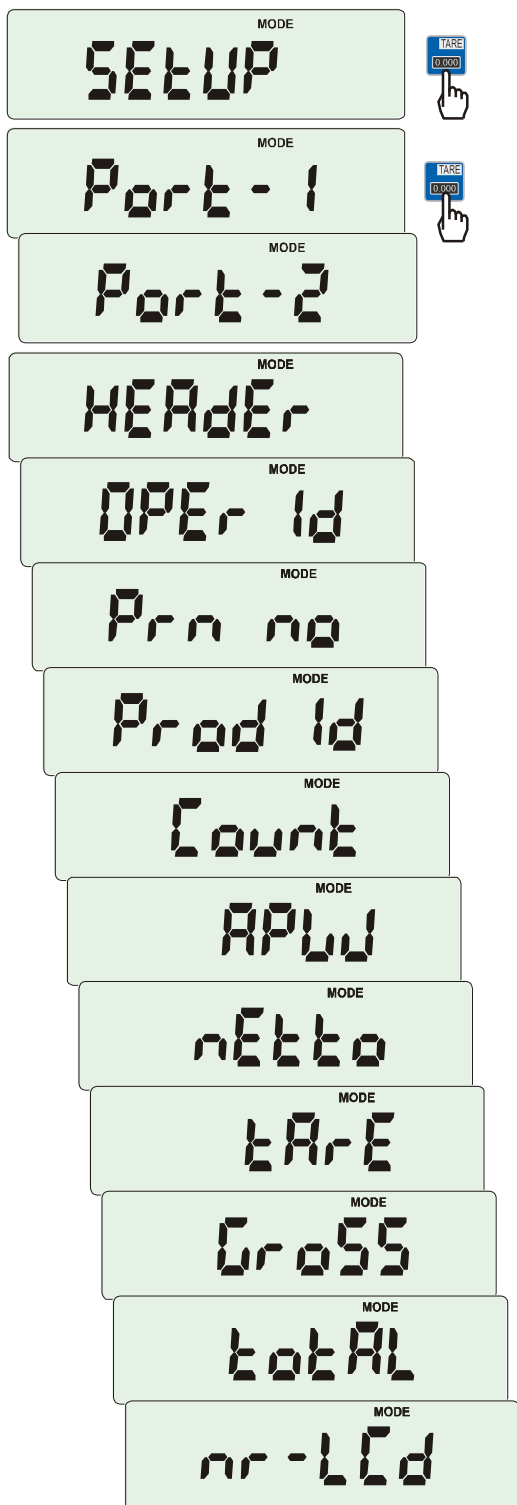
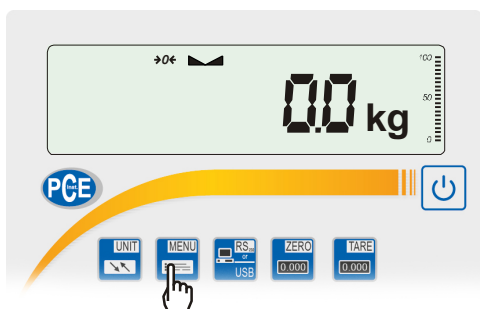

Function is used for printing additional information stored in scale memory, weighed product identification data and scale operator id. That information is inscribed using scale keys or scanner.





The function allows to switch on/off following positions on the printout:

- HEAdEr – header: name, model and scale number,
- USEr Id – scale user identification number,
- USEr nA – user name,
- Prn no – successive printout number (choose this option to zero counter),
- Prod Id – product number,
- Prod bA – product barcode (inscribed or scanned),
- Prod nA – product name,
- Count – counting result (PCS function),
- APW – unitary mass (PCS function),
- netto – net mass
- tArE – current tare value,
- GroSS – gross mass,
- totAL – total mass (*totAL* function)

Attention:

If *Prod Id* or *USEr Id* is chosen, it is possible to inscribe quickly their new values (with omission of main menu).

In order to do that hold (about 3 seconds) *MENU* key and release it when *Prod Id* or *USEr Id* indicates. Inscribe new value using keys:

-  - increasing digit,
-  - decimal point,
-  - next digit,
-  - end.

While inscribing *Prod id* user can use barcode reader connected to RS232C interface.

If the scale is equipped with two serial joints *Print* function is set independently for both interfaces.

Sample printout during normal weighing (all printout positions deactivated):

```
20.07 kg
20.04 kg
20.04 kg
```

Sample printout during normal weighing with clock option (all printout positions deactivated):

```
20.07 kg 2012-11-08 10:01
20.04 kg 2012-11-08 10:01
20.04 kg 2012-11-08 10:01
```

Sample printout during normal weighing (some printout positions activated):

```
BA30
MAX: 30kg e=d=0.01kg
S/N  :

ID OPER.      : 000001
DATE          : 2012-11-08
TIME          : 12:26
NO            :      3
ID PROD.      : 01
COUNT        : 0 PCS
APW           : 0.000 g
NET           : 3.08 kg
TARE          : 0.00 kg
GROSS         : 3.08 kg
TOTAL         : 0.00 kg
```

16.6 Setting backlight function (b_LIGHT)

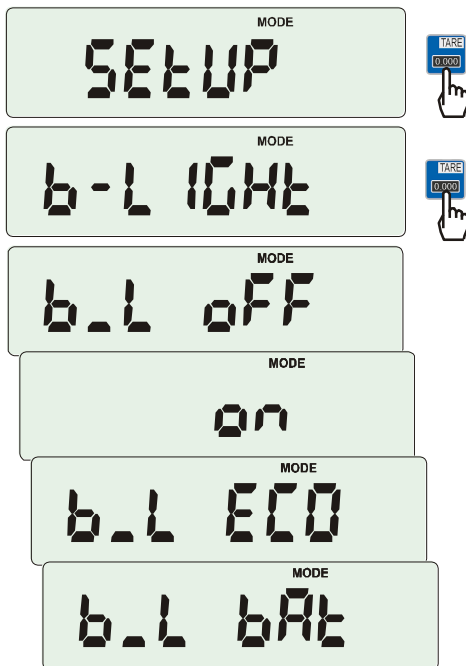
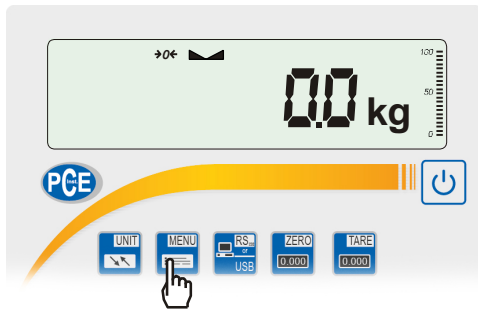

The function is used for choosing the work mode of scale display backlight:

- *b_L OFF* – switch backlight off,
- *b_L on* – switch backlight permanently on,
- *b_L ECO* – switch off after 30 seconds of inactivity (no load changes and no key operation),
- *b_L bAt* – like above, but when powering from accumulators only,
- *out* – out without changes.

Switching backlight off causes decrease of energy consumption by the scale, what is important during powering from accumulators.

16.7 Analog out configuration (AnALoG)

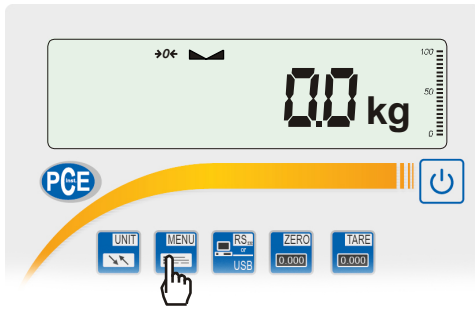

This option enables to set-up analog out (4-20mA or 0-10V) working method used e.g. in PLC regulators:

- *AnG mG* – inscribing Max value
- *AnG CFG* – working mode configuration (*PLUS* – workmode for only positive values, *MinuS* – only for negative values, *both* – for both)

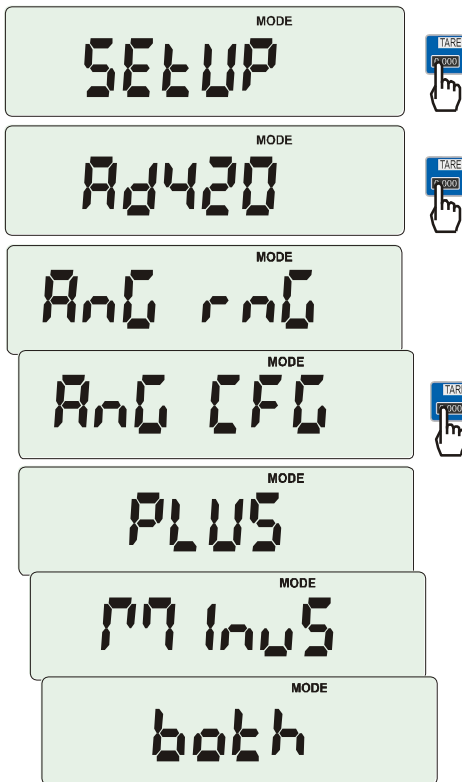

16.8 Entering reference zero value (ZErO)

Note: This function is enabled in non-legalized scales only.

ZErO function allows entering new value of reference zero (value referred to empty pan) without need of contacting with authorised service centre.

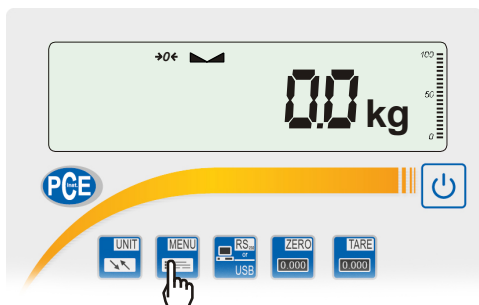

Press key.

When ZErO is displayed press key.

On the display a sign ZEr Cod will show up momentary and the a dash on last digit position.

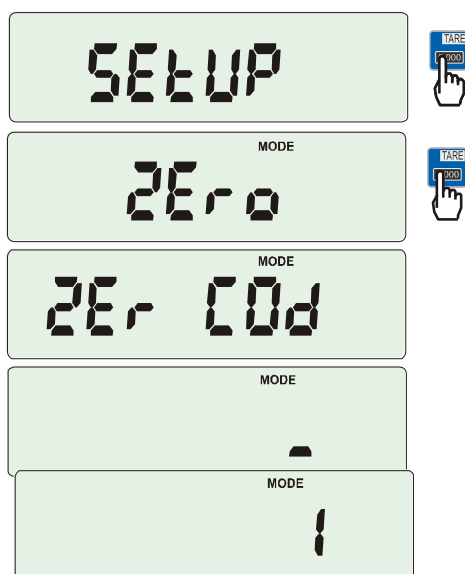

To enter code (in new scale: 1234) use keys:

- increasing digit,
- next digit,
- end of inscribing.

The following options appear successively on display:

- ZEr Cod – enter new secure code value,
- ZEr SEt – enter new zero value

Using key, choose ZEr SEt. Direct result from A/C converter will appear on scale display.

When the pan is empty press key.

Wait for finishing zeroing process.

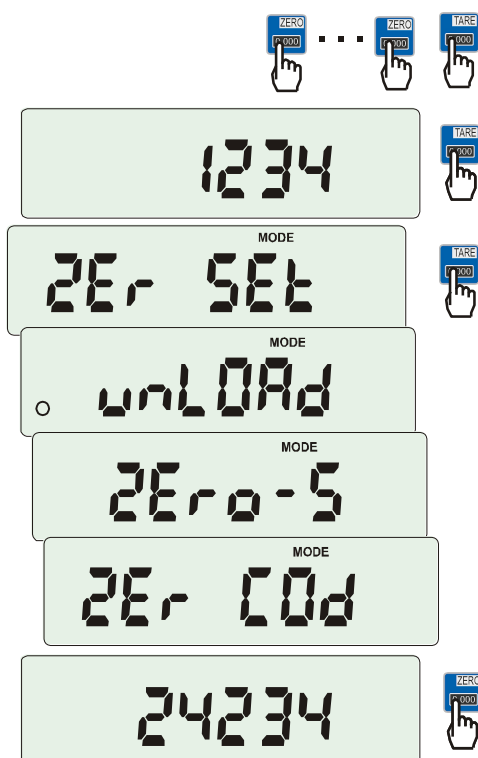

In order to change access code use ZEr Cod option (as mentioned earlier).

17. Special function description

All scales besides basic metrological functions: weighing and taring, have a set of special functions. Depending on meter type functions set differs. Below a list of functions available in standard ME-01 type meters:

- Products data base (*Prod*),
- Users data base (*USEr*),
- pieces counting function (*PCS*),
- change of mass unit (*UnIt*),
- percentage weighing function (*PErC*),
- selecting label number function (*LAbEL*),
- weighing large animals function (*LOC*),
- entering tare function (*tArE*),
- maximum value indication function (*UP*)
- force measuring function (*nEWton*)
- statistical calculations (*StAt*)
- paperweight calculation function (*PAPEr*)

and functions that require additional equipment to be completely functional:

- option with accumulator supply:
 - Setting accumulators charging (*bAttErY*)
 - Automatic switching off scale function (*AutoOFF*)
- options with the clock:
 - setting current date and time function (*dAtE*)
 - total weight function (*totAL*)
- options with the transoptors connectors (*WYŮ*):
 - checkweighing function (*thr*)
- option with radio connection:
 - function of choosing communication channel (*rF Chn*)

LabEL function is available in scales with EPL or EPL-A transmission protocol activates (go to *SetuP/SERIAL*).

In scales with LED display special functions don't have additional marks on display and names of some functions are shortened.

17.1 Products and users database (Prod i USEr)

Scale is equipped with products and users database with capacity up to 300 products and 10 users.

Database consists of:

- *M nr* – memory number where data is saved,
- *Prod Id* - product identification number,
- *Prod bA* – product barcode,
- *Prod nA* – product name,
- *USEr Id* – user identification number,
- *USEr nA* – user name,
- *APW* - unitary weight (used when pieces counting),
- *PtArE* - inscribing permanent tare to the product,
- *thr Lo* - threshold value (low),
- *thr Hi* - threshold value (upper).

Database can be build in Excel datasheet form, where each product has one row and each column have product data. This way created database, saved in *.csv extension with semicolons can be send to scale usind Scale Database software and scale's serisl interface. Scale Database is available on our webpage.

Database and possibility to cooperate with external devices: printer, label printer, barcode reader and computer enables to built product identification and product archiving systems.

Product barcode readout (during scale working) initiates searching through database and in case of finding proper record, recalls product data (*Found* communicate). Barcode reader enables also to insert numerical data conveniently (standard ME-01 meter doesn't have numerical keys). Using alphanumeric code (for example 128 code) it can be also used to insert names of products and users.

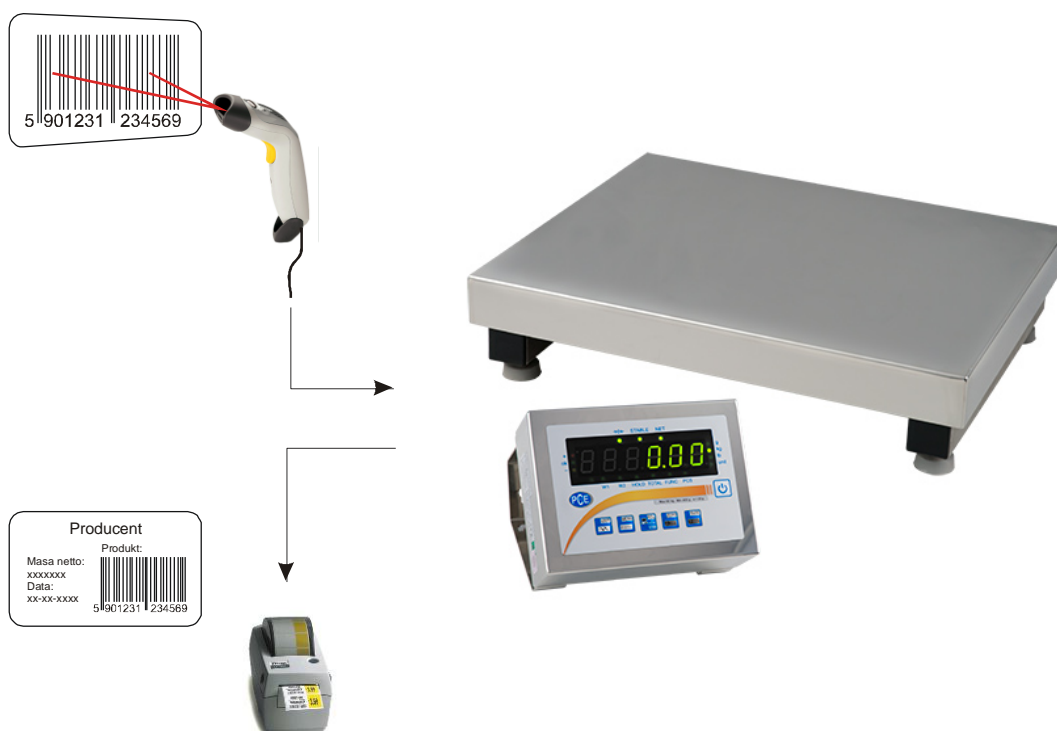

Inscribing data to base

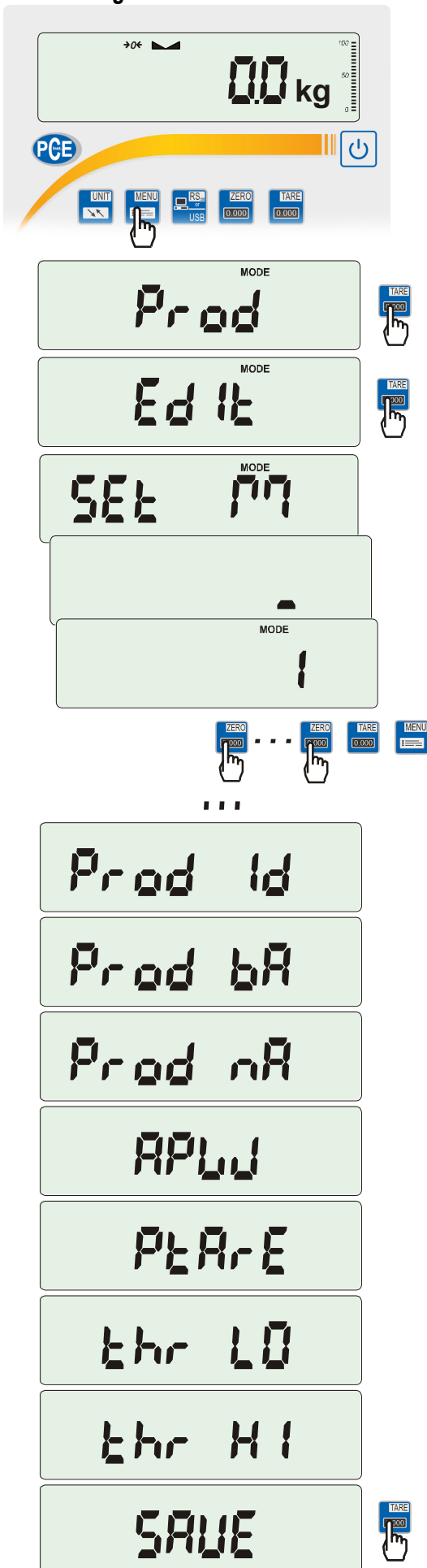

Prod and *USER* options enables adding and deleting product and user data.

For products database available options are:

- *EdIt* –
- *Add* – add product to database,
- *dEL OnE* – deleting single element from database
- *dEL ALL* – deleting all elements from database
- *dAtAb* – changing working mode with database (default mode *Stb*):
 - *Stb* – searching products in database and working with products outside the base; if product is found then *Found* communicate appears and all product data is recalled; if there is no product in database then no communicate appears, the scale stores id/barcode number temporarily in memory and enables to send it to the port (to printer/computer) together with actual weighing result.
 - *LIMIt* – searching through products from database; if product is found then *Found* communicate appears and all product data is recalled; if there is no product in database then *not Found* communicate appears.
- *Prn_P* – sending all products database to port.

To inscribe data use *EdIt* option and keys:

- increasing digit,
- next digit,
- end of inscribing.

Barcode reader (connected to RS232C interface) can also be used to inscribe data and this way it is faster and more effective.

Each database product has following data:

- *M Id* – memory cel number in products database,
- *Prod Id* – product identification number,
- *Prod bA* – product barcode,
- *Prod nA* – product name (inscribed from PC or barcode reader),
- *APW* – product unitary weight (optional),
- *PtArE* – product package weight (optional),
- *thr LO* – lower threshold (MIN value),
- *thr HI* – upper threshold (MAX value).

Saving inscribed product data is done by using *SAVE* option.

Users database is edited by similar function named *USER* and consists of several options:

- *USER Id* – user identification number,
- *USER nA* – user name (inscribed from PC or scanner),
- *Pm_U* – sending users database to port.

Saving data is also done by *SAVE* option.

Recalling from database

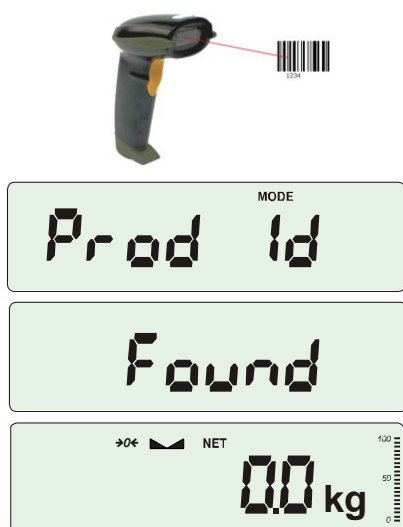

The fastest way to recall product from database is to readout his barcode number (*Prod bA*) by using barcode reader (option). It can be done in any moment.

After readout of proper barcode scale indicates one of communicates:

- *SCAN* – barcode from outside the base accepted (*Std* mode),
- *not Found* – barcode from outside the base not accepted (*LIMIt* mode),
- *Found* – product barcode found in database and data recalled.

Attention: If the scale doesn't indicate any communicate, check barcode reader connections, port configuration and transmission protocol (*SERIAL* function).

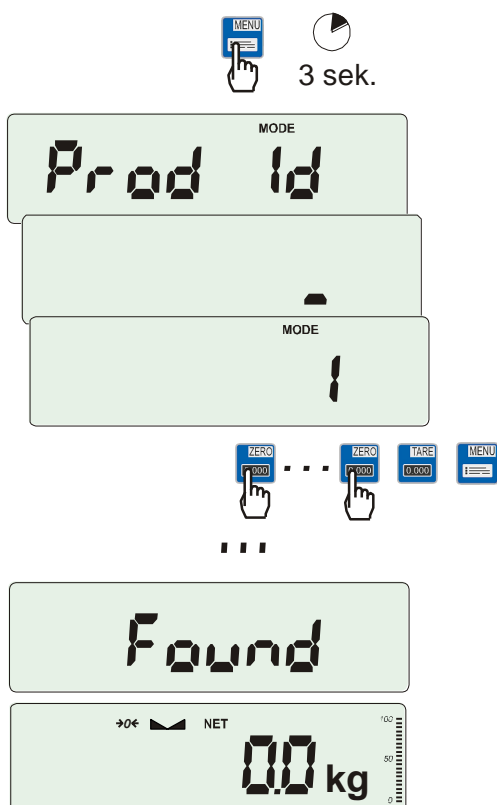

Other fast way is to press and hold *MENU* key. *Prod Id* communicate indicates and after a few seconds user can inscribe identification number. If the number is already saved in base *Found* communicate appears and all the product data is recalled.

To edit data choose *EdIt* option and use following keys:

- increasing digit,
- next dixit,
- end of inscribing.

Product recalling is also possible by using *Prod* and *Prod Id* options (previous site).

Weighing results and data transmission from scale to computer or to printer

To each weighing results transmission a set of product and user identification data is added. The set is activated in Print option.

Available data from products and users base (*Print / SEtuP* option):

- *USEr Id* – user identification number,
- *USEr nA* – user name (inscribed from PC or scanner).
- *Prod Id* – product identification number,
- *Prod bA* – product barcode (inscribed or scan),
- *Prod nA* – product name (inscribed from PC or scan).

17.2 Pieces counting function (PCS)

The diagram illustrates the PCS function steps. It shows a scale with a pan containing 5 pieces, then 10 pieces. The display shows '0.0 kg', '1.3 kg', 'PCS', 'PCS OFF', 'PCS on', 'PCS ..', 'PCS 5', 'PCS 500', 'PCS SET', 'PC APW', 'PCS r5', '5 pcs', and '15 pcs'.

This function enables to count identical pieces, e.g. turnbuckles or buttons.

A measurement is performed in two phases:

- first phase - single piece weight calculation on the basis of defined pieces amount (5, 10, 20, 50, 100, 200 or 500 pieces),
- second phase – pieces counting.

First phase options:

- PCS .. – recalling of a value inserted earlier (this quantity must be inscribed earlier),
- PCS SET – set any amount of pieces in a sample,
- PCS APW – set unitary mass directly,
- PCS rS – inserting number of details in a sample and receiving of their mass from other scale connected by RS-232C.

It is advised that single piece weight is not less than one reading unit and sample weight used in first phase is bigger than 100 reading units.

To leave function press **MENU** key and then using **TARE** key choose PCS and PCS OFF.

Note:

1. APW too LOW communicate signalises that a sample was not put on the pan or if single piece weight is less than one-tenth readout plot (counting is not possible).
2. APW LOW communicate signalizes that single piece weight is more than one-tenth but less than one readout plot. (counting possible but with bigger errors, result blinks).
3. In scales equipped with LED display pcs sign is replaced with "■".

17.3 Percentage weighing function (PErC)

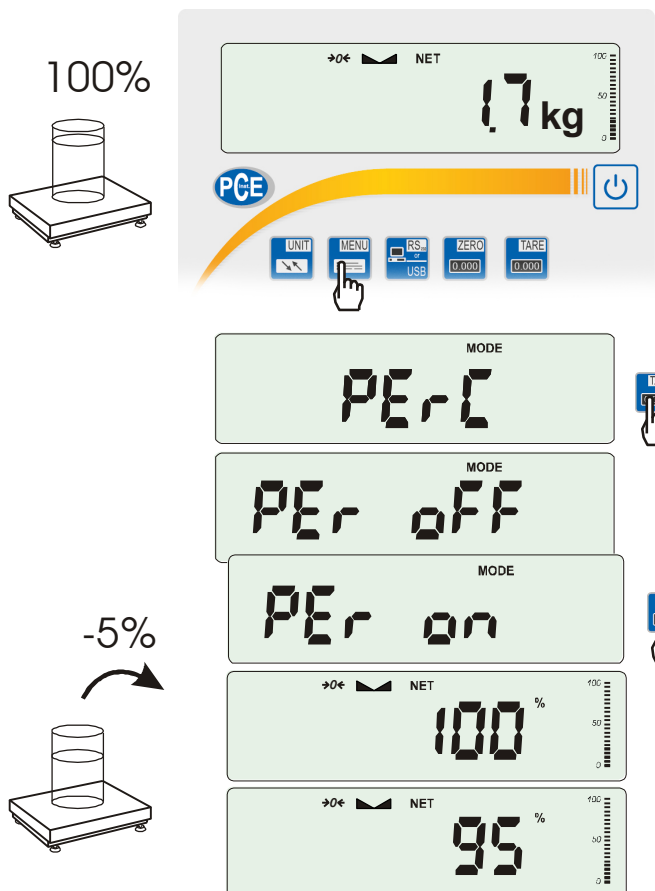

This function allows displaying weighing result in percents.

A measurement is performed in two phases:

- first phase – weighing a reference sample (100%),

- second phase – measuring specific sample as a percentage of the reference sample.

Weighing result is displayed in different format, depending on the weight value of reference sample.

The function has the following options:

- *PEr OFF* – disable the function,
- *PEr ON* – set current scale indication as 100% and activate percentage weighing,
- *out* – exit without changing settings.

Note:

1. *PEr Err* message informs that reference 100% mass is less than 0,5*Min or was not defined.
2. In scales with LCD display sign "■" is replaced with %.

17.4 Label choosing function (LAbEL)

This function is used in scale with *ELTRON* (*SERIAL* function) data protocol. This protocol enables label printout with actual scale indication and chosen data from *Print* special function (variable data), for example date and time. Other data, for example company address, product name, barcode can appear on label as a constant text. Label patterns with number (4 digit) used by user should be saved in scale memory according to printer manual. Label pattern choice is made by inscribing label number using *LAbEL* function.

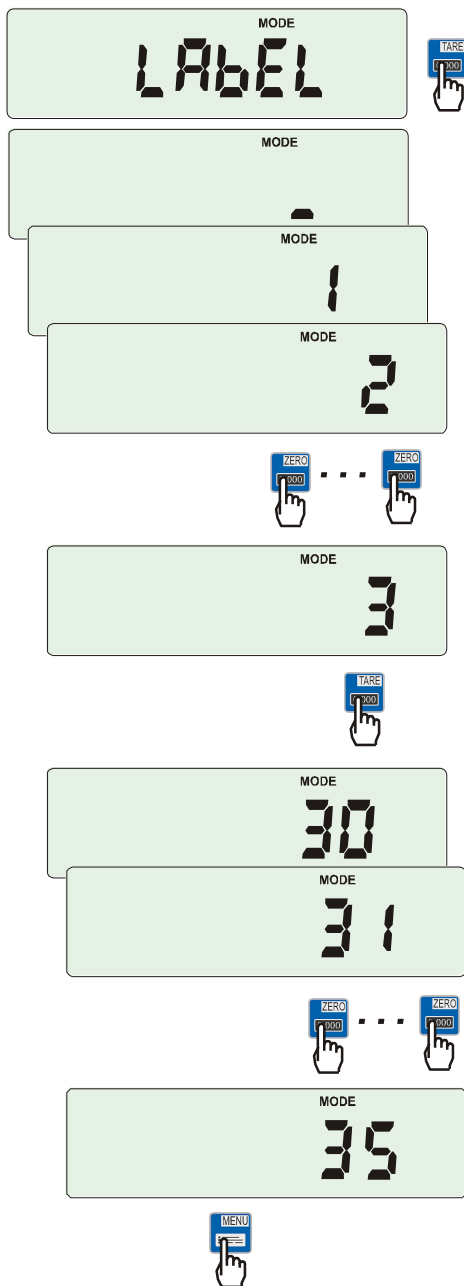

Press button.

When LAbEL is displayed, press key. Actual label number will show.

To enter new label number, press key, to exit function without number change, press .

To inscribe label number use keys:

- increasing digit,
- next dixit,
- end.

After entering label number, putting load and pressing key will cause sending data to label printer.

Data format sent to label printer (label nr 1, language EPL-2):

US	(55 53 0D 0A)
FR"0001"	(46 52 22 30 30 30 31 22 0D 0A)
?	(3F 0D 0A)
00:00	(30 30 3A 30 30 0D 0A)
2000.00.00	(32 30 30 30 2E 30 30 2E 30 30 0D 0A)
10 g	(20 20 20 20 20 31 30 20 20 67 0D 0A)
P1	(50 31 0D 0A)

17.5 Weighing animals function (LOC)

The function allows weighing animal moving on the scale.

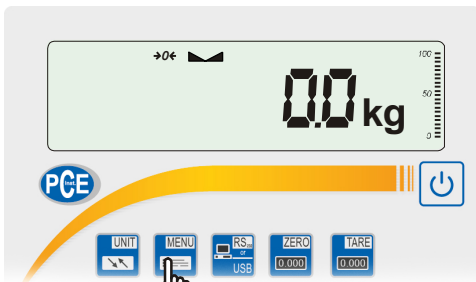

Press  key.

When LOC function is displayed press  key. The following options appear on display successively:

- LOC off – leave the function,
- LOC on – automatic weighing after loading the scale,
- LOC Prn – the measurement initiated manually by pressing  key.

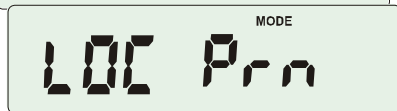
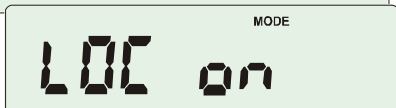

When LOC on is displayed press  key.

Tare the scale using  key if necessary and place the animal on the pan.

Wait until the weighing result is averaged – scale display blinks. Then scale will show stable (averaged) result and will send it through serial port.

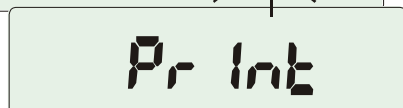
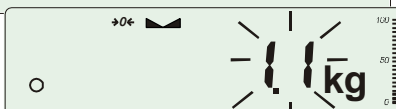
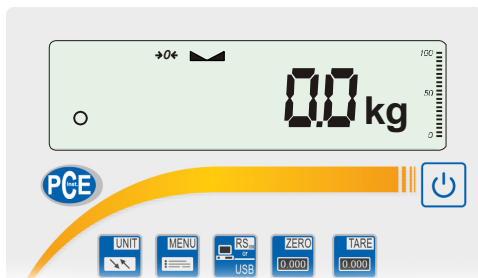

The result remains on display for about 30 second.



Important notes:

1. The loads lower than Min value are not averaged.
2. In case when putting animal on scale takes more than 5s it is suggested to choose LOC PRN option (measurement started manually by pressing  key).

17.6 Constant tare memory function (tArE)



This function enables to measure gross weight of a sample placed in a container of a known weight value (stored in the memory) and to display calculated net weight of the sample. Tare value is recalled from the memory with  or  key when the pan is empty. Tare value may be entered using keypad or by putting container on the pan.

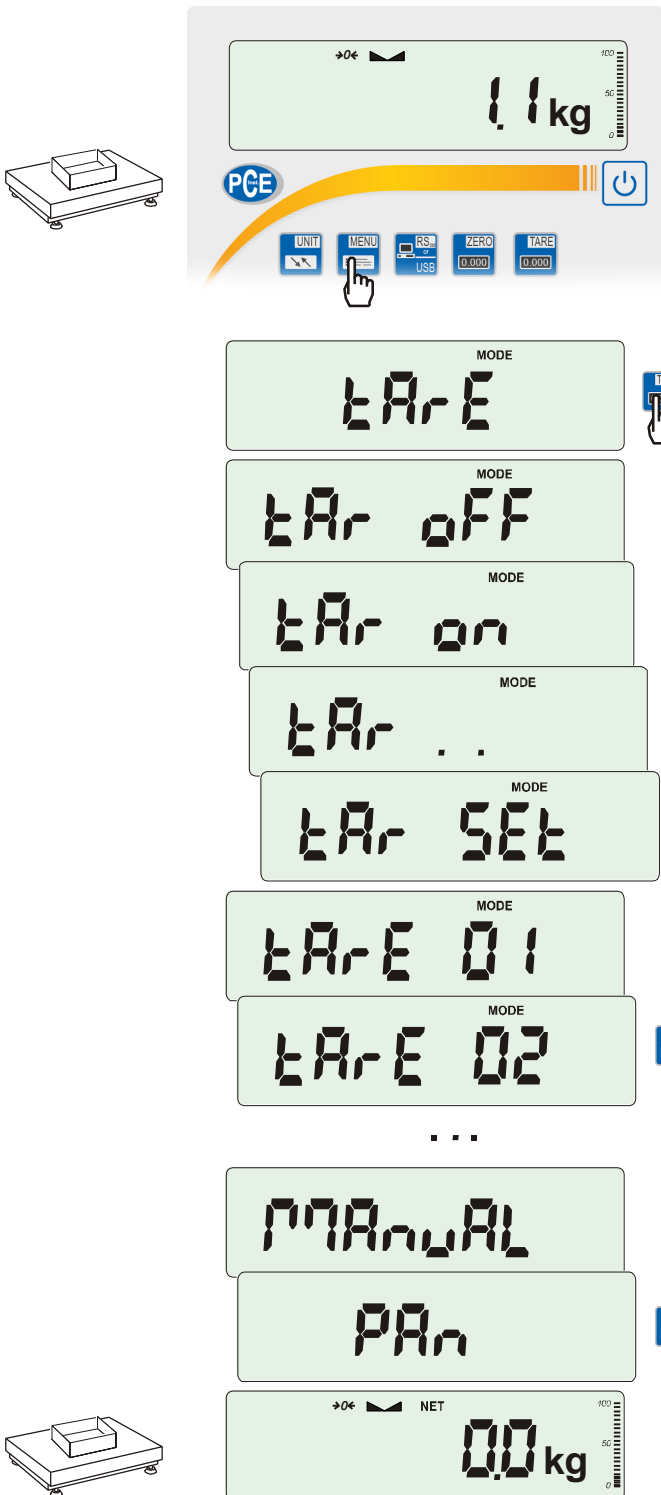



Inscribing tare value to memory:





The diagram illustrates the sequence of screen displays during the tare inscription process:





- Initial display: 1.1 kg
- Press MENU: tArE (MODE)
- Press TARE 0.000: tAr OFF (MODE)
- Press TARE 0.000: tAr on (MODE)
- Press TARE 0.000: tAr .. (MODE)
- Press TARE 0.000: tAr SET (MODE)
- Press TARE 0.000: tArE 01 (MODE)
- Press TARE 0.000: tArE 02 (MODE)
- Press TARE 0.000: ...
- Press TARE 0.000: MANUAL
- Press TARE 0.000: PAN
- Press TARE 0.000: NET 0.0 kg

After pressing  key and choosing tArE function, using  key, the following options are available:

- *tAr OFF* – leave the function,
- *tAr on* – activate the function with the previous tare value,
- *tAr ..* – sample tare value from the pan,
- *tAr SET* – enter tare value with keys: , ,  and 
- *out* – printout a setting value of tare.

Press  key when *tAr SET* is displayed. By pressing  key choose proper memory cell where tare will be stored: *tAr 01, 02, ... , 10*.

Choose inscribing method :

- *MANUAL* – inscribing using keys: , ,  and ,
- *Pan* – inscribing mass value that is on the pan.

After storing tare, the scale starts working with inscribed tare value.

Note:

Tare value is stored in memory also after unplugging the scale from the mains.

Weighing with constant tare

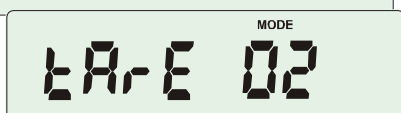
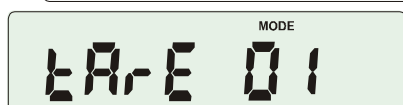
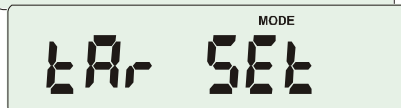
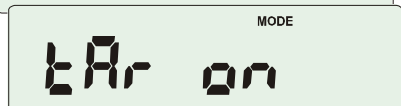
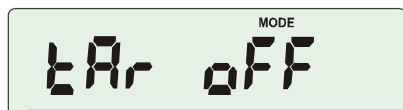
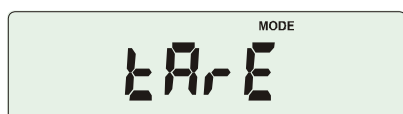
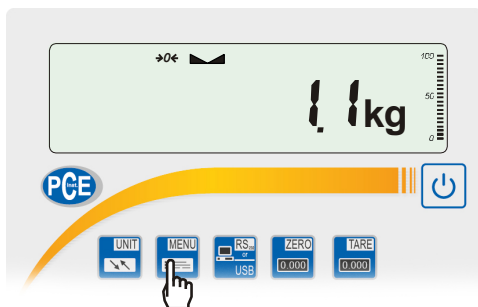
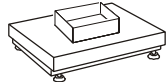

...

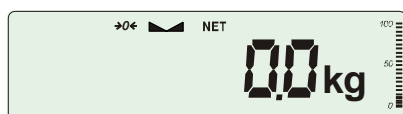

In order to use tare value that is located in memory, choose from menu *tArE* function and then *tAr on* option.



A list of memory cells will show up:

tAr 01, 02, ... , 10.

Cells with inscribed value are marked with "o" sign on the left side, active value marked with "▲".

ATTENTION: In scales with LED display, cells with inscribed value are marked with "■".

Choose proper memory cell using  key .

tArE function is activated with chosen tare value. Moreover the scale will indicate net weight (weight on the pan minus tare values). Using  key (or  , while empty pan) causes scale zeroing and then subtraction of recalled tare. Minus indication will show up.

17.7 Maximum value indication function (UP)

This function allows holding maximum (or minimum) value that is indicating at the moment.

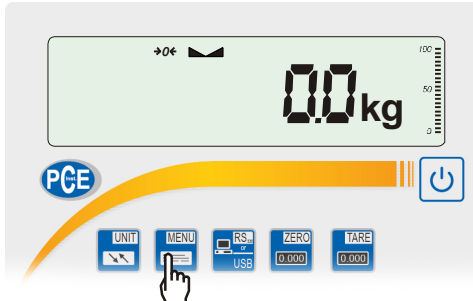

Before measurement scale should be tared.

Function has following options:

- UP OFF – function off,
- HIGH – holding maximum value,
- LOW – holding minimum value.

Pressing  key will cause result zeroing.



Note:

Autozeroing function and the stabilisation indicator are deactivated when UP function is running.

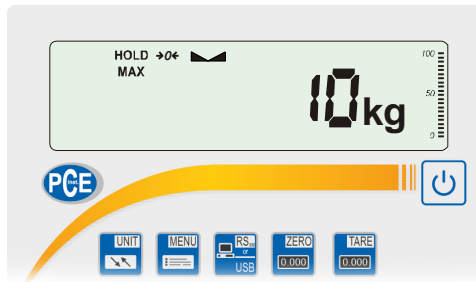
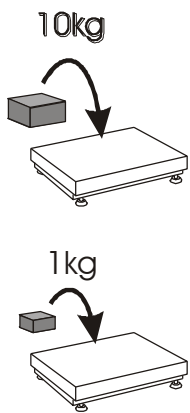

17.8 Force measuring function (nEWton)

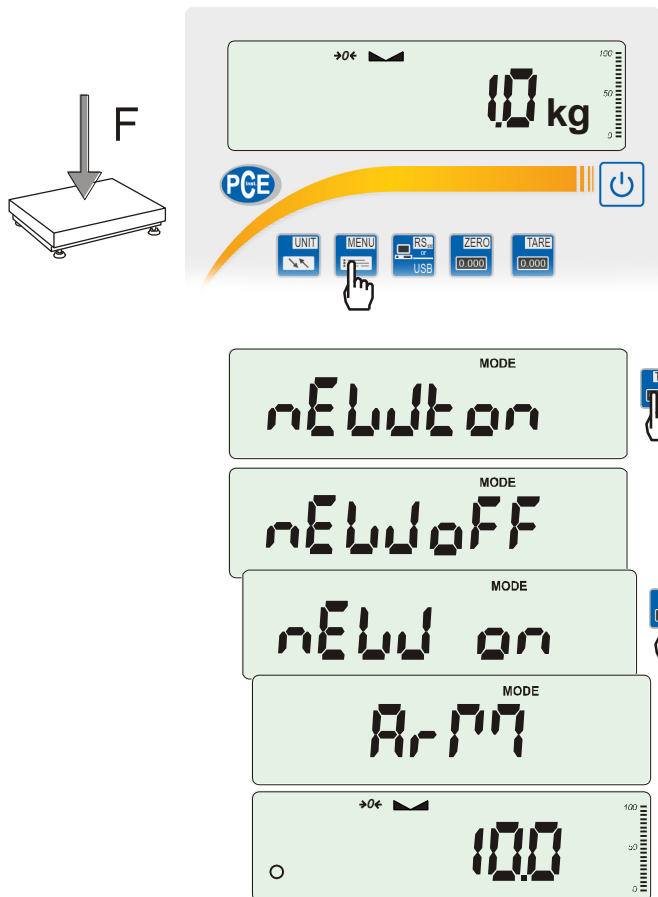

Function activation causes displaying result in force units (N).



Press  key.

Using  key choose *NEWto* function.

Function has several options:

- *nEW off* – function off,
- *nEW on* – measurement in Newtons,
- *ArM* – torque measurement (arm length should be inscribed in meters using ,  and  keys).

Attention:

Units conversion from mass (kg) to force (N) is made for acceleration of gravity ($g=9,80665\text{m/s}^2$)

Note: $1\text{N} \approx 0,1019\text{kg}$

17.9 Total weight function (totAL)

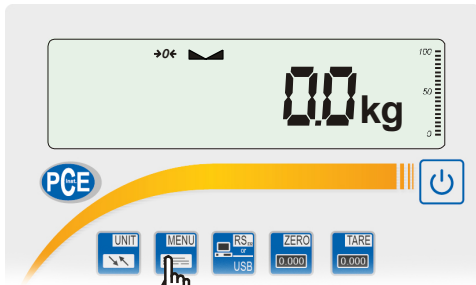

The function allows calculating total weight for series of measurements, which can be greater than scale capacity. It allows calculating total weight as well as average value.

Press key.

When *totAL* is displayed press key.

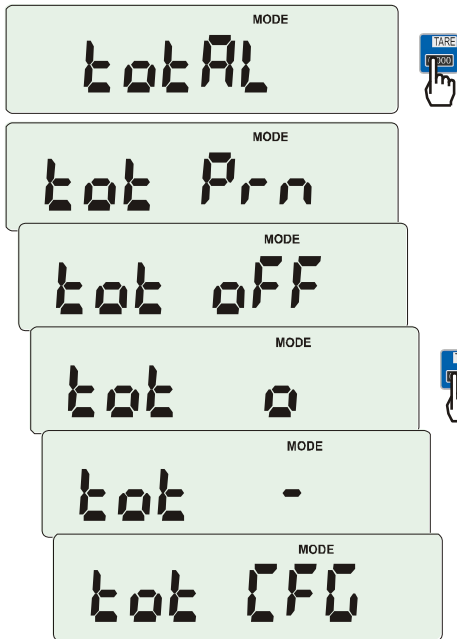

The following options will appear successively:

- *tot Prn* - report printout without clearing total register,
- *tot OFF* - clearing total register, report printout and leaving the function,
- *tot □* - working with receipt printout after each measurement,
- *tot -* working without receipt printout,
- *tot CFG* – saving measurement mode (using key: *Manual*, after taking off the load : *auto*).

Press key when *tot □* is displayed.

Perform measurement series by pressing key for storing results into total register.

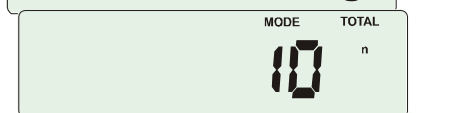
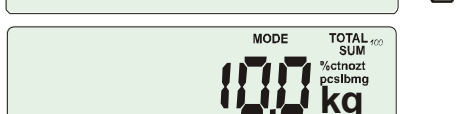
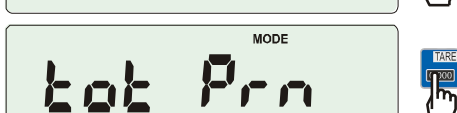
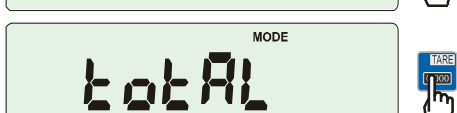
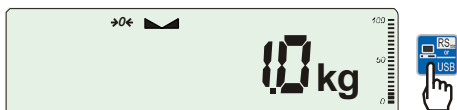
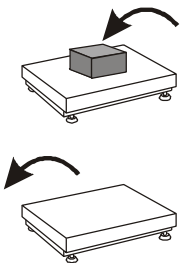

In order to print and display results enter the function by choosing *totAL* and *tot Prn* option from menu.

The results are displayed in the following sequence:

- total weight (SUM ≡),
 - number of registered measurements (n),
 - average value (=),
- regarding that moving to display successive result is performed after pressing key.

Attention: In scales with LED display SUM sign is replaced by “≡”.

In order to go back to total weighing without zeroing total register press key several times.

USER MANUAL

To leave the function with clearing total register, select *totAL* function from menu and choose *tot oFF* option. Scale prints the communicate informing about clearing registers.

The form of receipt after each measurement:

Date: ...	Time. ...
measurement no	weight
measurement no	weight

Report form:

Date: ...	Time. ...
TOTAL WEIGHT	=
NUMBER OF SAMPLES	=
AVERAGE VALUE	=

Note:

When the scale doesn't have an internal clock, Date and Time do not appear on printout.

Maximum number of measurements is 99 999.

Maximum total load 99 999 000d.

The weighing unit of the total value from the register (Total) is the same as the weighing unit stated on the keypad or is 1000 times greater, what is signalled by "o" indicator at the left of the display.

If the registered value is too big to be displayed, "E" communicate appears on the display. If the number of series is too high and cannot be displayed, "Err1" communicate appears on the display

17.10 Checkweighing function (thr)

This function allows comparing weighing result with two programmed reference values: lower and upper threshold. Comparison result is signalled with indicators (MIN, OK, MAX) and sound signal generated when threshold values are exceeded.

If comparison result is:

- smaller than zero threshold – no signal,
- smaller than lower threshold – the scale signals MIN (yellow colour),
- between threshold values - the scale signals OK (green colour, with the short sound signal),
- greater than upper threshold - the scale signals MAX (red colour, long sound signal).

The checkweighing results can be use to control:

- optical indicator (*Indication mode*),
- batching devices (*Batching mode*).
-

Standard scale is set for cooperation with optical indicator.

On outputs P1-P3 (*Relays socket*) short-circuit states appear as result of comparison scale indication with threshold values.

On the chart below output states are shown during increasing load on the scale for both working modes:

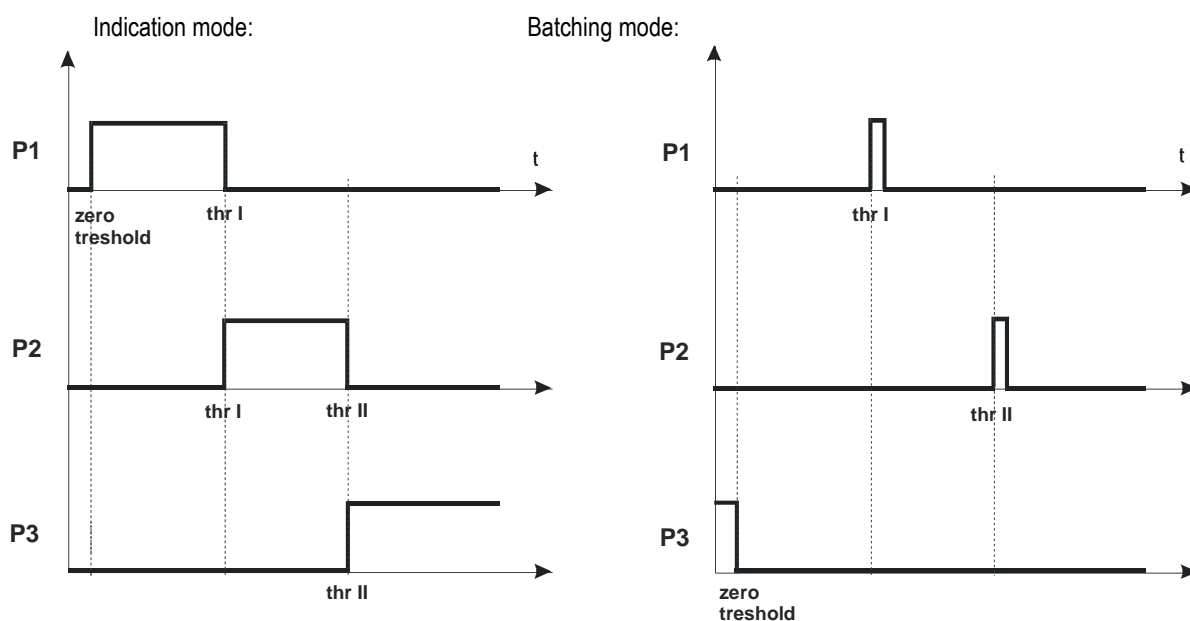

In *Batching mode* on P1 (thr I) and P2 (thr II) outputs short-circuit impulses appears for time of 0,5s. On P3 (zero) output short-circuit state appears when indication does not exceed threshold value signalling zero load.

Operation sequence:

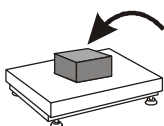
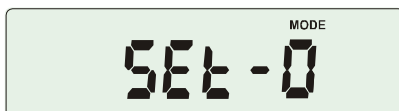
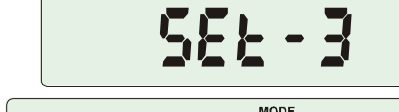
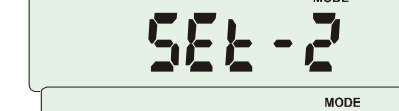
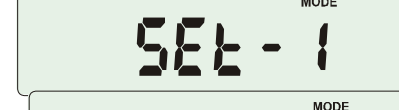
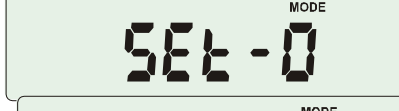
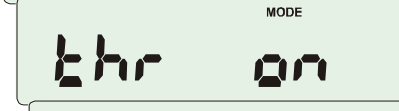
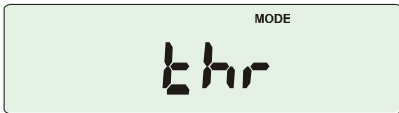

Press key and choose thr pressing key.

The following options are displayed successively:

- *thr off* – deactivate the function,
- *thr on* – activate the function,
- *thr Prn* – check last threshold values (press key several times),
- *thr CFG* – choose *Relays* socket mode:
 - 0 – exit to weighing
 - 1 – *Batching* mode
 - 2 – *Indication* mode.

Choose *thr-on* option using key. The following options for entering thresholds are displayed:

- *SEt-0* - go to weighing with signalling threshold excess,
- *SEt-1* - set lower threshold value,
- *SEt-2* - set upper threshold value,
- *SEt-3* - set zero signalisation threshold.

Using key, select *SEt-1* option. Set lower threshold value using the following keys:

- digit increase,
- decimal point,
- move to next digit,
- finish.

Then select *SEt-2* option and enter upper threshold value.

Choosing *SEt-0* option will cause starting work with signalisation of exceeding thresholds and zero.

To change *Relays* socket mode use *thr CFG* option. Default option is *Indication*.

To leave the function, press key and then choose *thr* and *thr off* options.

Relays connection diagram:

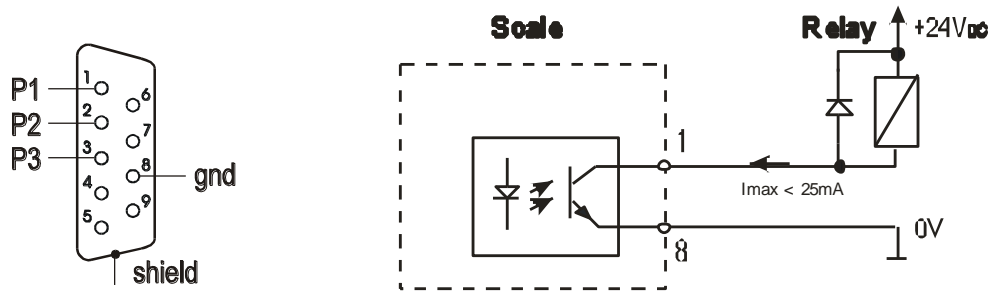

Relays output is the open collector transistor output with load capacity 25mA / 24V. Transmitter inputs must be protected with diodes, e.g. 1N4148.

It is advised to use MS3K/P electronic board (sold separately), consisting of RM96P transmitters, with DC24V input voltage and AC250V, 3A output.

Important notes:

1. After switching the scale on, both thresholds are set to maximum values.
2. When setting upper threshold value, pay attention that its value is not below lower threshold value.
3. Setting lower and upper threshold value is possible after sending appropriate orders from computer, what is described in scale user manual.

17.11 Setting date and time function (dAtE)

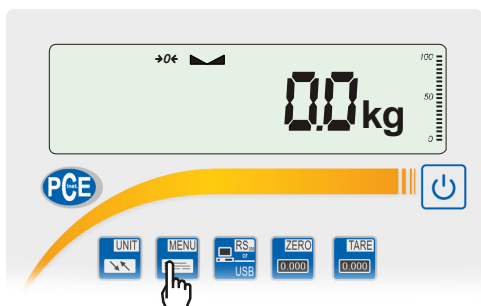

The function allows setting current date and time of scale internal clock and mode of its use.

The function has the following options:

- *dAt OFF* – deactivate date and time during printout of current weighing result,
- *dAt on* – activate date and time during printout of current indication ( key),
- *dAt SET* - change current date and time,
- *dAt PIn* – data and time secure password (to prevent from changing date and time by unauthorized personnel),
- *dAt For* – data printout in *USA* or *EU* format.



The example at the left presents how to set current date and time using *dAt SET* option.

After setting proper date and time activate it with *dAt on* option.

UE: rrrr-mm-dd gg:mm

USA: mm-dd-rrrr gg:mm AM/PM



(gg – hours, mm – minutes, AM – before noon, PM – after noon, mm - month, dd - day, rrrr - year).

Attention: Inscripting non-zero *PIN* value causes showing *PIN* sign during next date and time changing and inscribing 4 digit code is necessary. (using keys ,  and ).

17.12 Radio communication channel choose function (rF CHn)

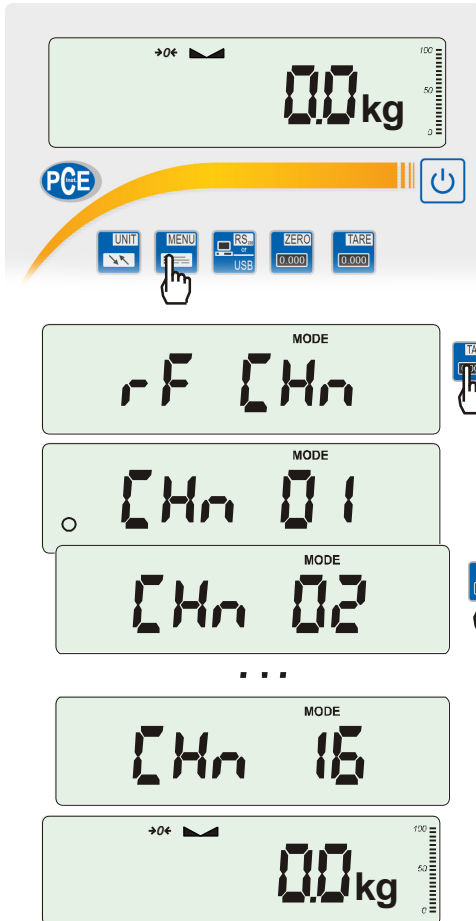
Function enables choosing radio communication channel between the scale and a pilot. In scale and in pilot the same radio channels must be chosen. Function should be used when communication is disturbed by other devices that use the same communication channel.



Press  key and choose rF CHn by pressing  key.

The following communicates will appear on display successively:

- CHn 01 – channel 1,
- CHn 02- – channel 2
- ...
- CHn 16 -- channel 16
- out – out without changing channel.

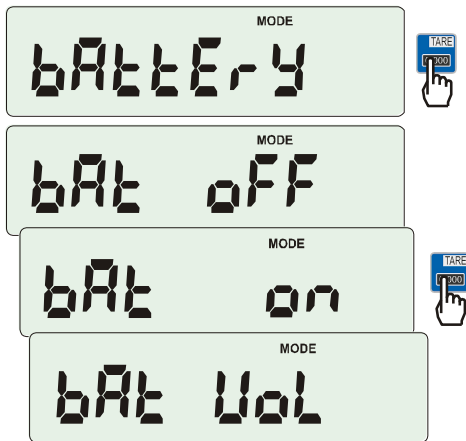
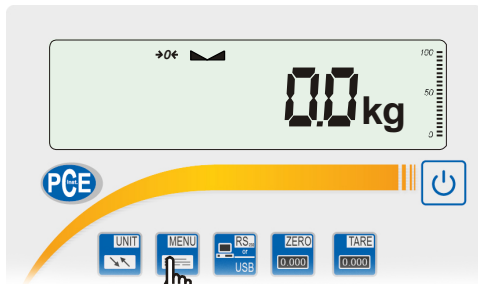

In default setting channel 01 is on.

17.13 Charging accumulators function (bAttErY) - option



bAttErY function allows switching on or off charging accumulators during work with feeder and checking their power level.

The function has the following options:

- *bAt OFF* – charging off (option required if ordinary batteries are used !!!),
- *bAt on* - charging on, accumulators are being charged even after switching scale off using  key,
- *bAt Vol* - reading power level of accumulators in % (go back to mass indication, pressing  key),
- *out* – leave without changes

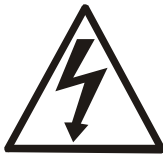

An attempt of charging ordinary batteries can cause serious damage of the scale.

17.14 Automatic switching off the scale function (AutoOFF)

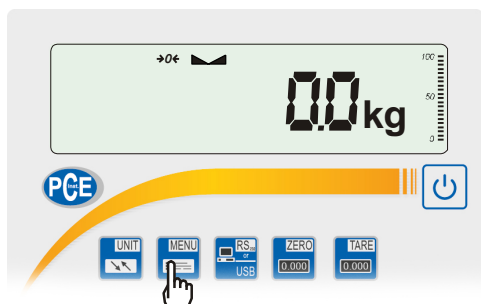

The function is helpful in scales supplied from accumulators. The function causes scale to switch off automatically.

Press  key.

When *AutoOFF* is displayed press  key.

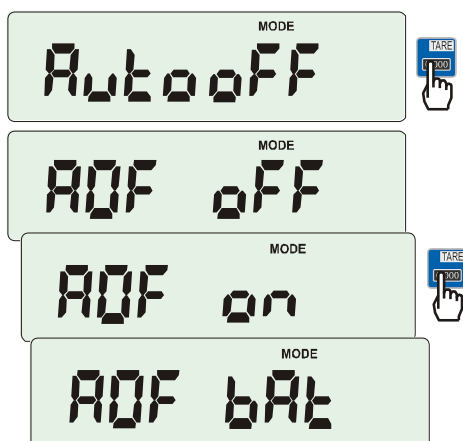

The following options appear successively on display:

- *AOF OFF* – deactivate function,
- *AOF on* – activate function- scale turns off after 5 minutes of not making any actions,
- *AOF bAt* – as above but only when supplied from accumulators.
- *Out* – out without changes.



Order of operations:

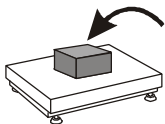
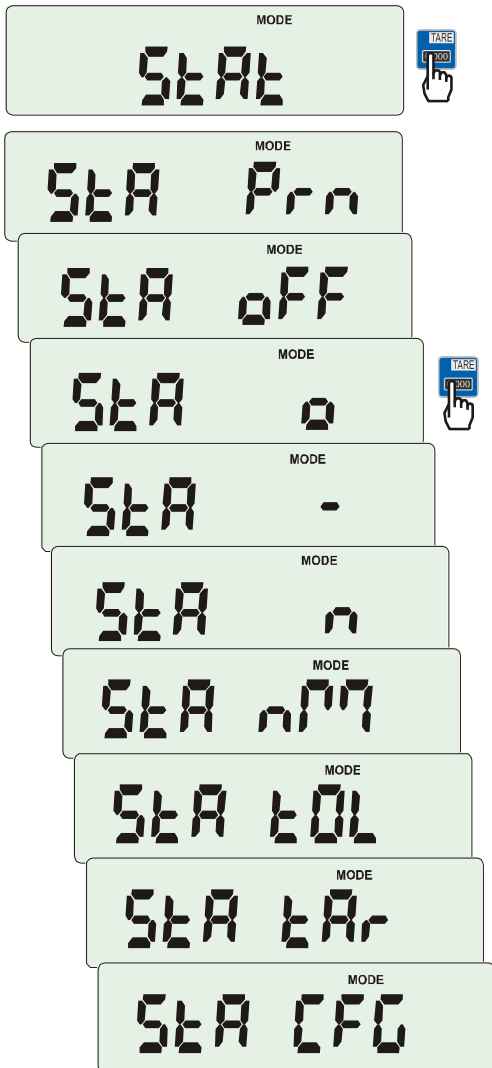
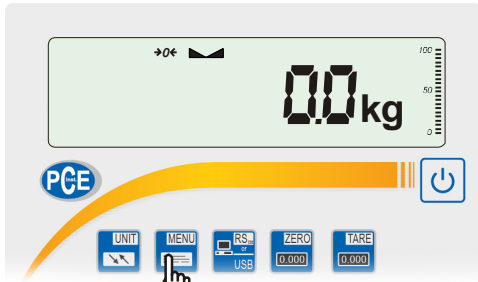

Press key.

When StAt is displayed, press key.

The following options are displayed:

- *StA Prn* – monitoring and printout of statistical data,
- *StA oFF* – deactivate function,
- *StA □* – activate function, work with printout of chosen weighting results,
- *StA --* – activate function, work without printout,
- *StA n* – maximal samples value,
- *StA nM* – inscribing nominal value for statistics,
- *StA tOL* – inscribing tolerance in %,
- *StA tAr* – automatic tare on/off
- *StA CFg* – function configuration:
 - *Auto* – Automatic work (samples are confirmed after loading the scale and indication stabilization.),
 - *ManuAL* – manual work (confirmation is made by pressing key).
- *out* – exit from function.

Remember first to inscribe nominal weight value and tolerance (mentioned above).

After that, push key when StA o is displayed.

Put on successive objects on the pan (remove after indication stabilization) in order to add them to measurements register.

In order to obtain printed statistical results from measurements series, press key and key when StAt is displayed and later StA Prn.

After printout two options are enabled:

- *rESET* – erasing results,
- *Contin* – continuation.

Pressing  key printouts estimated values and histogram :

Nominal - nominal value,

Tolerance - accepted value in percentage.

N - number of sample

IN TOL. – number of samples in toleranc

-TOL – amount of measurements

under allowable lower value

+TOL – amount of measurements above

allowable upper value

TOTAL - sum of weights of all n samples

AVERAGE – average weight as (Total)/n

MIN – minimum weight in n samples

MAX– maximum weight in n samples

ST. DEV. – standard deviation

ST. DEV.% – standard deviation percentage

To finish work with this function and

zeroing result register press 

key and then when StAt. and Sta oFF is

displayed press  button.

Statistics function cooperation with computer and

Printer. Scale can be equipped with two serial ports

marked as RS232C-I (computer) and RS232C-II

(printer). After each data printout by printer identical

set of data is sent to computer. After sending by

computer initialization signal S A CR LF

(53h 49h 0Dh 0Ah) the scale sends to computer

statistic data enclosed in histogram.

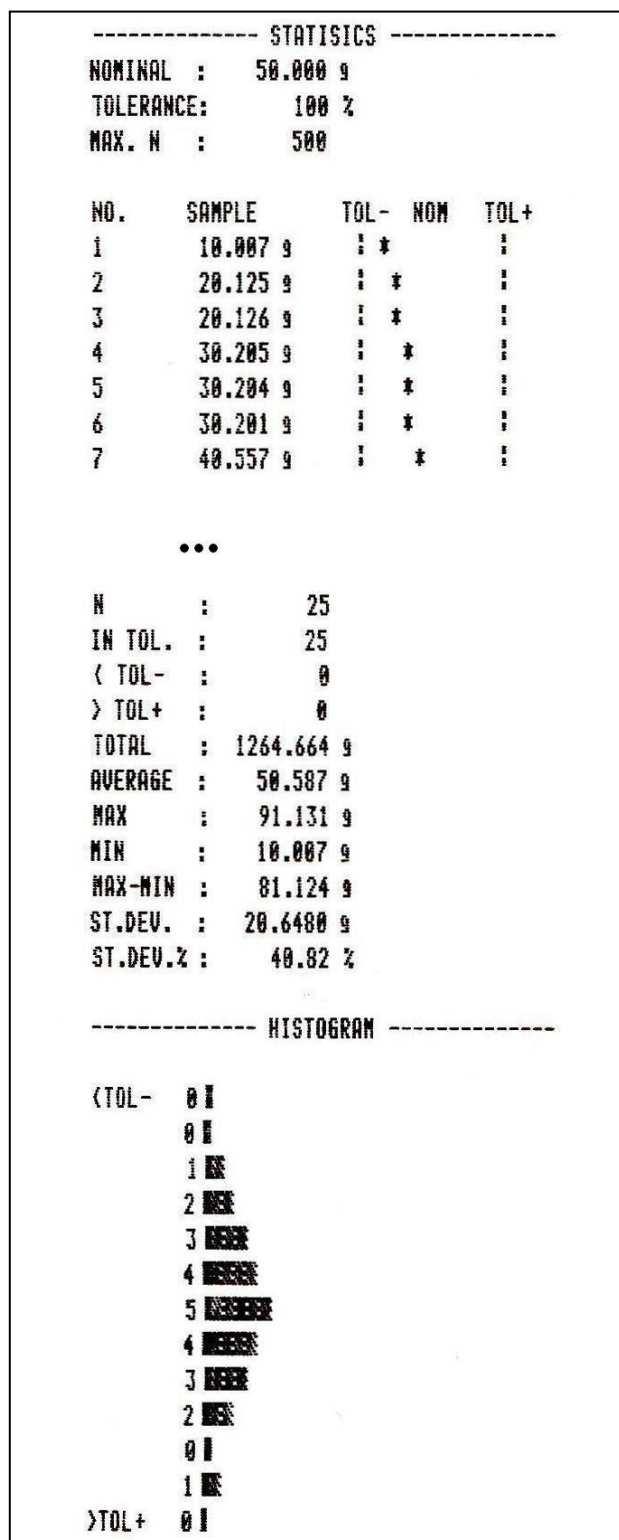

17.16 Paperweight calculation (PAP)

5

00kg

PCE

UNIT MENU RS-232C USB ZERO 0.000 TARE 0.000

MODE PAP Err

MODE PAP OFF

MODE PAP on

MODE PAP n

MODE PAP ArE

MODE 10 pcs

MODE

MODE 1

ZERO 0.000 ZERO 0.000 TARE 0.000 MENU

...

MODE 5 pcs

MODE PAP on

80

This function enables to calculate paperweight of 1m² of paper basing on samples of known area. For quick access, the function is accessible directly by pressing key.

The balance must be tared just before the measurement.

Place the specific sample quantity of the same area (possible values: 1, 2, 5, 10, 20, 50, 100).

Press key to access function menu. To enter the function press key when *PAPER* is displayed.

Following options show on the display:

- *PAP OFF* – turn off the function,
- *PAP on* – turn on,
- *PAP n* – inscribing number of paper pieces on pan,
- *PAP ArE* – inscribing surface of single piece (in m²)

Press key when *PAP ArE* is displayed.

Enter number of samples using:

- increasing digit,
- next digit,
- end of inscribing.

Press key when *PAP ArE* is displayed.

Enter area of a single sample (as above).

The result of paperweight measurement is finished with „o” mark pointing g/m² unit.

In order to finish work with function, press and then using key choose *PAPER* and *PAP OFF*.

Note:

“PAP Err” communicate marks that wrong values were inscribed in *PAP n* or *PAP ArE*.

18. Maintenance and repair of small defects

1. The scale should be kept clean. The balance must be kept clean and protected from dust, and aggressive liquids. In order to clean it is recommended to wipe the scale with cloth soaked in soapy water and then dry.
2. Take care that no dirt gets between the platform and the scale base. If found any, remove the pan (lift it up), remove dirt and then replace the pan.
3. In case of improper operation caused by short-lasting power supply decay, unplug the scale from the mains and then plug it again after few seconds.
4. If the scale is switched on with empty pan and "SErvice" communicate appears, the load cell has been mechanically damaged.
5. It is forbidden to make any repairs by unauthorised persons.
6. To repair the scale, please contact our nearest service.

Error communicates:

Communicate	Possible cause	Remedy
<i>C-1 ... 6</i> (over 1 min.)	selftests failed	if displayed more than 1 minute, contact an authorised service
unLOAD /SErvice	the scale was switched on with loaded pan	remove a load from the pan
	mechanical damage of the load cell	contact an authorised service
<i>L</i>	pan missing	put the pan on
	mechanical damage	contact an authorised service
<i>H</i>	overloading	remove the load from the pan
	mechanical damage	contact an authorised service
 indicator does not appear	unstable ground vibrations air flows	place the scale on a stable ground not affected by mechanical vibrations and airflows
	scale is damaged	contact an authorised service
- - - - -	taring in progress	as above
- -	taring could not be finished (the load is too small or B\G key was used)	zero the scale or press B\G key again
- -	the load is too big to be zeroed	tare the scale (→T←)

Konformitätserklärung

Certificate of conformity



Hiermit erklären wir, dass die Bauart der nachfolgend bezeichneten, elektronischen, nichtselbsttätigen Waage

Benennung / Name :	Plattformwaage
Typ / Type :	PCE-SD Serie
Nr. der EG-Bauartzulassung / Approval No. of EC:	T8418
Eichklasse / accuracy class :	III
Herstellernummer / Serial number:	
Benannten Stelle für die EG Bauartzulassung:	0122 / NMI / NL

dem in der Bescheinigung über die Bauartzulassung beschriebenen Baumuster sowie den geltenden Anforderungen folgender EG-Richtlinien entspricht:

We hereby declare that the product to which this declaration refers conforms with the following standards:

EG-Waagerichtlinie: **2009/23/EC**
Council Directive: PN-EN 45501:1999

EG-EMV-Richtlinie: **2004/108/WE**
Electromagnetic compatibility (EMC): PN-EN 61000-4-3+A1:2008+A2:2011
PN-EN 61000-6-3:2008+A1:2011

EG-Niederspannungsrichtlinie: **2006/95/EG**
Low Voltage Directive: PN-EN 61010-1:2004

Die Konformitätserklärung gilt bezüglich der EG-Waagerichtlinie nur in Verbindung mit einer Konformitätsbescheinigung einer benannten Stelle.

Der vorstehende Satz entfällt, wenn die nichtselbsttätige Waage von PCE Deutschland GmbH geeicht wurde.

Datum: 01.01.2014

Information's concerning double-range scale (option)

1. General description

Double-range scale's have capability of work with greatest accuracy in bottom measuring range part. Weighing of smallest mass is more precise.

This type of scale's have two measurement range:

- Max_1 - 50 % of maximum load (mostly),
 - Max_2 – 100% of maximum load,
- and adequate reads digit: d_1 i d_2 ($d_1 < d_2$).

Double-range options causes change of scale's operation:

- after turn on (in small mass range 0- Max_1) scale displays result with reading unit d_1 ,
- when the load pass the Max_1 scale changes reading unit on d_2 ; from this moment scale displays result with reading unit d_2 on all measure range (0- Max_2),
- return to unit d_1 is succeed after zeroing the scale ( key), or when all mass is removed from pan (indicator "Zero").

