



# Network Video Recorder

## User's Manual







# Foreword

## General

This user's manual (hereinafter referred to be "the Manual") introduces the installation, functions and operations of the Network Video Recorder (NVR) devices (hereinafter referred to be "the Device"). Read carefully before using the Device, and keep the manual safe for future reference.

## Safety Instructions

The following signal words might appear in the manual.

Signal Words	Meaning
 <b>DANGER</b>	Indicates a high potential hazard which, if not avoided, will result in death or serious injury.
 <b>WARNING</b>	Indicates a medium or low potential hazard which, if not avoided, could result in slight or moderate injury.
 <b>CAUTION</b>	Indicates a potential risk which, if not avoided, could result in property damage, data loss, reductions in performance, or unpredictable results.
 <b>TIPS</b>	Provides methods to help you solve a problem or save you time.
 <b>NOTE</b>	Provides additional information as a supplement to the text.

## Revision History

Version	Revision Content	Release Time
V2.3.1	Added 8 models.	February 2023
V2.3.0	<ul style="list-style-type: none"> <li>Added smart tracking and sub screen mirroring.</li> </ul>	August 2022
V2.2.0	Added Analytics+ SSA and Quick Pick.	June 2022
V2.1.0	Updated cluster service.	April 2022
V2.0.0	<ul style="list-style-type: none"> <li>Added intelligent diagnosis.</li> <li>Added report query.</li> <li>Added resetting password through DMSS app.</li> <li>Added LLDP.</li> <li>Updated several figures of the local interface.</li> </ul>	March 2022

Version	Revision Content	Release Time
V1.3.0	<ul style="list-style-type: none"> <li>Added some models.</li> <li>Updated the web login page.</li> <li>Added privacy masking.</li> <li>Added Analytics+ codec.</li> </ul>	November 2021
V1.1.0	Combined Analytics+ and non-Analytics+ models and deleted discontinued models.	May 2021
V1.0.10	Added several models.	April 2021
V1.0.9	Added 6 models.	February 2021
V1.0.8	Added 5 models.	January 2021
V1.0.6	<ul style="list-style-type: none"> <li>Added picture search, picture search playback, disk health monitoring, and exporting and importing face database.</li> <li>Updated Analytics+ search, human detection, configuration of Face Detection+, and display settings.</li> </ul>	May 2020
V1.0.5	Added split tracking, main-sub tracking, analytics list, configuring video quality analytics, iSCSI, and cluster service.	May 2020
V1.0.4	<ul style="list-style-type: none"> <li>Added 16 models.</li> <li>Added PoE status, switch, and display.</li> </ul>	April 2020
V1.0.3	<ul style="list-style-type: none"> <li>New GUI baseline, replaces all interfaces.</li> <li>Added Analytics+ functions.</li> </ul>	July 2019
V1.0.2	Updated the description of rear panel.	May 2019
V1.0.1	<ul style="list-style-type: none"> <li>Updated icons on the rear panel.</li> <li>Added video metadata function and non-motor vehicle detection function.</li> </ul>	September 2018

## Privacy Protection Notice

As the device user or data controller, you might collect the personal data of others such as their face, fingerprints, and license plate number. You need to be in compliance with your local privacy protection laws and regulations to protect the legitimate rights and interests of other people by implementing measures which include but are not limited to: Providing clear and visible identification to inform people of the existence of the security area and provide required contact information.

## About the Manual

- The manual is for reference only. If there is inconsistency between the manual and the actual product,
- We are not liable for any loss caused by the operations that do not comply with the manual.
- The manual would be updated according to the latest laws and regulations of related regions. For detailed information, see the paper manual, CD-ROM, QR code or our official website. If there is inconsistency between paper manual and the electronic version, the electronic version shall prevail.
- All the designs and software are subject to change without prior written notice. The product updates might cause some differences between the actual product and the manual. Please contact the customer service for the latest program and supplementary documentation.
- There still might be deviation in technical data, functions and operations description, or errors in print. If there is any doubt or dispute, please see our final explanation.
- Upgrade the reader software or try other mainstream reader software if the manual (in PDF format) cannot be opened.
- All trademarks, registered trademarks and the company names in the manual are the properties of their respective owners.
- Please visit our website, contact the supplier or customer service if there is any problem occurred when using the device.
- If there is any uncertainty or controversy, please see our final explanation.



# Important Safeguards and Warnings

This section introduces content covering the proper handling of the Device, hazard prevention, and prevention of property damage. Read carefully before using the Device, and comply with the guidelines when using it.

## Transportation Requirements



Transport the Device under allowed humidity and temperature conditions.

## Storage Requirements



Store the Device under allowed humidity and temperature conditions.

## Operation Requirements



- Do not place the Device in a place exposed to sunlight or near heat sources.
- Keep the Device away from dampness, dust, and soot.
- Install the Device on a stable surface to prevent it from falling.
- Do not drop or splash liquid onto the Device, and make sure that there is no object filled with liquid on the Device to prevent liquid from flowing into it.
- Put the Device in a well-ventilated place, and do not block its ventilation.
- Operate the Device within the rated range of power input and output.
- Do not disassemble the Device.
- Use the Device under allowed humidity and temperature conditions.

## Installation Requirements



- Do not connect the power adapter to the device while the adapter is powered on.
- Strictly comply with the local electric safety code and standards. Make sure the ambient voltage is stable and meets the power supply requirements of the device.
- Do not expose the battery to environments with extremely low air pressure, or extremely high or low temperatures. Also, it is strictly prohibited to throw the battery into a fire or furnace, and to cut or put mechanical pressure on the battery. This is to avoid the risk of fire and explosion.
- Use the standard power adapter or cabinet power supply. We will assume no responsibility for any injuries or damages caused by the use of a nonstandard power adapter.



- Do not place the Device in a place exposed to sunlight or near heat sources.
- Keep the Device away from dampness, dust, and soot.
- Put the Device in a well-ventilated place, and do not block its ventilation.
- Install the Device on a stable surface to prevent it from falling.
- The power supply must conform to the requirements of ES1 in IEC 62368-1 standard and be no higher than PS2. Please note that the power supply requirements are subject to the device label.
- The device is a class I electrical appliance. Make sure that the power supply of the Device is connected to a power socket with protective earthing.
- Use power cords that conform to your local requirements, and are rated specifications.
- Before connecting the power supply, make sure the input voltage matches the power requirements of the Device.
- When installing the Device, make sure that the power plug and appliance coupler can be easily reached to cut off power.
- Install the Device near a power socket for emergency disconnect.
- It is prohibited for non-professionals and unauthorized personnel to open the Device casing.

# Table of Contents

Foreword .....	I
Important Safeguards and Warnings .....	IV
1 Introduction.....	1
1.1 Overview .....	1
1.2 Features .....	1
2 Front Panel and Rear Panel .....	4
2.1 Front Panel.....	4
2.1.1 N41C1P/N41C2P .....	4
2.1.2 N42C1P/N42C2P/N42C3P/N52B5P/N54A4P/N54B3P/N54B5N .....	6
2.1.3 N82B2P/N82B3P/N82B5P .....	7
2.1.4 N84B3P/N84B3N/N84B5N .....	8
2.1.5 N98A5N/N98A6N/N98A7N .....	9
2.2 Rear Panel.....	10
2.2.1 N41C1P/N41C2P.....	10
2.2.2 N42C1P/N42C2P/N42C3P/N52B5P/N54A4P/N54B3P/N54B5N .....	11
2.3 Alarm Connection .....	14
2.3.1 Alarm Port .....	14
2.3.2 Alarm Input Port.....	14
2.3.3 Alarm Output Port.....	16
2.3.4 Alarm Relay Specifications .....	17
2.4 Two-way Talk.....	17
2.4.1 Device-end to PC-end.....	17
2.4.2 PC-end to the Device-end .....	18
3 Device Installation.....	19
3.1 Device Installation Diagram.....	19
3.2 Checking Unpacked NVR.....	20
3.3 HDD Installation .....	20
3.3.1 N41C1P/N41C2P.....	20
3.4 CD-ROM Installation.....	23
3.5 Connection Sample.....	27
3.5.1 N41C1P/N41C2P.....	27
3.5.2 N42C1P/N42C2P/N42C3P/N52B5P/N54A4P/N54B3P/N54B5N .....	28
3.5.3 N42C1P/N42C2P/N42C3P/N52B5P/N54A4P/N54B3P/N54B5N .....	29

---

4 Starting the Device .....	30
5 Local Operations .....	31
5.1 Initialization .....	31
5.2 Startup Wizard .....	34
5.3 Login .....	39
5.4 Main Menu .....	41
5.5 Quick Operation Bar .....	43
5.6 Live View .....	44
5.6.1 Live Page .....	45
5.6.2 Navigation bar .....	45
5.6.3 Live View Control Bar .....	46
5.6.3.1 Instant Playback .....	47
5.6.3.2 Digital Zoom .....	48
5.6.3.3 Instant Backup .....	49
5.6.3.4 Manual Snapshot .....	49
5.6.3.5 Two-way Talk .....	49
5.6.3.6 Stream Switch .....	49
5.6.3.7 Picture Search .....	50
5.6.3.8 Quick Pick .....	51
5.6.4 Shortcut Menu .....	53
5.6.5 Analytics+ Live View Mode .....	56
5.6.6 Split Tracking .....	58
5.6.7 PTZ .....	60
5.6.7.1 PTZ Settings .....	60
5.6.7.2 PTZ Control .....	62
5.6.7.3 Configuring PTZ Functions .....	64
5.6.7.3.1 Configuring Presets .....	64
5.6.7.3.2 Configuring Tours .....	65
5.6.7.3.3 Configuring Patterns .....	65
5.6.7.3.4 Configuring AutoScan .....	66
5.6.7.4 Using PTZ Functions .....	67
5.6.7.4.1 Presets .....	67
5.6.7.4.2 Tours .....	67
5.6.7.4.3 Patterns .....	67
5.6.7.4.4 AutoScan .....	67
5.6.7.4.5 Calling AutoPan .....	68

---

---

5.6.7.4.6 Auxiliary Button .....	68
5.6.8 Wireless Pairing .....	68
5.6.9 Sequence.....	69
5.6.10 Fisheye.....	72
5.6.10.1 Fisheye De-warp on Live View Interface .....	72
5.6.10.2 Fisheye De-warp During Playback.....	74
5.6.11 Temperature Monitoring .....	74
5.6.12 Shortcut Menu to Add Camera .....	75
5.6.13 Smart Tracking .....	76
5.7 Camera .....	76
5.7.1 Initializing Remote Devices.....	76
5.7.2 Adding Remote Devices.....	81
5.7.2.1 Adding Cameras from Search.....	81
5.7.2.2 Adding Cameras Manually.....	83
5.7.2.3 Importing Cameras.....	85
5.7.3 Changing IP Address of Remote Device.....	86
5.7.3.1 Changing IP Address of Connected Remote Device.....	87
5.7.3.2 Changing IP Address of Unconnected Cameras .....	87
5.7.4 Configuring Image Settings .....	87
5.7.5 Configuring Overlay Settings.....	91
5.7.5.1 Overlay .....	91
5.7.5.2 Privacy Masking.....	91
5.7.6 Configuring Encoding Settings.....	92
5.7.6.1 Configuring Audio and Video Encoding Settings .....	92
5.7.6.2 Snapshot .....	95
5.7.7 Modifying Channel Name.....	97
5.7.8 Checking the PoE Status .....	97
5.7.9 Updating Remote Devices .....	98
5.7.10 Viewing Remote Device Information .....	99
5.7.10.1 Device Status.....	99
5.7.10.2 Firmware.....	100
5.8 Recording Management .....	101
5.8.1 Recording Schedule.....	101
5.8.1.1 Configuring Video Recording Schedule .....	101
5.8.1.2 Configuring Snapshot Schedule.....	106
5.8.1.3 Configuring Recording Mode.....	107

---

5.8.2 Search and Playback .....	109
5.8.2.1 Search Page.....	109
5.8.2.2 Playback .....	111
5.8.2.3 Smart Search Playback .....	114
5.8.2.4 Clipping Videos.....	114
5.8.2.5 Backing Up.....	115
5.8.2.6 File List.....	116
5.8.2.7 Tag Playback.....	116
5.8.3 Recording Information .....	117
5.9 Analytics+ .....	118
5.9.1 Overview.....	118
5.9.2 Smart Plan.....	119
5.9.3 Face Detection .....	120
5.9.3.1 Enabling Smart Plan .....	120
5.9.3.2 Configuring Face Detection.....	120
5.9.3.3 Analytics+ Search (Face Detection).....	122
5.9.4 Face & Body Detection .....	124
5.9.4.1 Enabling Smart Plan .....	124
5.9.4.2 Configuring Face & Body Detection .....	124
5.9.4.3 Analytics+ Search (Face & Body Detection) .....	125
5.9.5 Face Detection+.....	125
5.9.5.1 Enabling Smart Plan .....	126
5.9.5.2 Creating Face Database.....	126
5.9.5.2.1 Creating Local Face Databases.....	126
5.9.5.2.2 Creating Remote Face Databases .....	127
5.9.5.2.3 Creating the Passerby Database .....	127
5.9.5.3 Adding Images to Face Database.....	128
5.9.5.3.1 Adding Face Images One by One.....	128
5.9.5.3.2 Adding Face Images in Batches .....	131
5.9.5.4 Configuring Face Detection+ .....	132
5.9.5.4.1 Configuring Analytics+ by recorder .....	132
5.9.5.4.2 Configuring Analytics+ by camera.....	134
5.9.5.5 Analytics+ Search (Face Detection+).....	135
5.9.5.5.1 Search by Attributes .....	135
5.9.5.5.2 Search by Image .....	137
5.9.5.5.3 Report Query.....	138

---

5.9.6 IVS .....	139
5.9.6.1 Enabling Smart Plan .....	139
5.9.6.2 Configuring IVS.....	140
5.9.6.2.1 Tripwire .....	140
5.9.6.2.2 Intrusion .....	142
5.9.6.2.3 Abandoned Object Detection.....	145
5.9.6.2.4 Fast Moving .....	148
5.9.6.2.5 Parking.....	151
5.9.6.2.6 Crowd Gathering.....	154
5.9.6.2.7 Missing Object Detection .....	157
5.9.6.2.8 Loitering Detection.....	160
5.9.6.3 Analytics+ Search (IVS) .....	163
5.9.7 Stereo Analysis.....	164
5.9.7.1 Enabling Smart Plan.....	165
5.9.7.2 Configuring Stereo Analysis .....	165
5.9.7.2.1 People Approach Detection .....	165
5.9.7.2.2 Fall Detection.....	166
5.9.7.2.3 Violence Detection .....	168
5.9.7.2.4 People No. Exception Detection .....	169
5.9.7.2.5 People Stay Detection.....	170
5.9.7.3 Analytics+ Search (Stereo Analysis).....	171
5.9.8 Video Metadata .....	172
5.9.8.1 Enabling Smart Plan .....	173
5.9.8.2 Configuring Video Metadata.....	173
5.9.8.3 Analytics+ Search (Video Metadata) .....	175
5.9.8.3.1 Human Detection .....	175
5.9.8.3.2 Motor Vehicle Detection .....	176
5.9.8.3.3 Non-motor Vehicle Detection .....	178
5.9.8.3.4 Report Query.....	179
5.9.9 ANPR.....	180
5.9.9.1 Adding Vehicle Blocklist and Allowlist.....	181
5.9.9.2 Configuring ANPR.....	182
5.9.9.3 Analytics+ Search (ANPR).....	183
5.9.10 Crowd Distribution .....	183
5.9.10.1 Enabling Smart Plan.....	183
5.9.10.2 Configuring Crowd Distribution.....	183

---

5.9.10.3 Report Query .....	184
5.9.11 People Counting .....	185
5.9.11.1 Enabling Smart Plan .....	185
5.9.11.2 Configuring People Counting .....	185
5.9.11.3 Configuring In Area No. ....	187
5.9.11.4 Queuing.....	188
5.9.11.5 Report Query.....	189
5.9.12 Heat Map.....	189
5.9.12.1 Enabling Smart Plan.....	190
5.9.12.2 Configuring Heat map .....	190
5.9.12.3 Report Query .....	191
5.9.12.3.1 General .....	191
5.9.12.3.2 Fisheye .....	192
5.9.13 SMD.....	192
5.9.13.1 Enabling Smart Plan.....	192
5.9.13.2 Configuring SMD .....	192
5.9.13.3 Analytics+ Search (SMD) .....	195
5.9.14 Vehicle Density.....	195
5.9.14.1 Enabling Smart Plan.....	195
5.9.14.2 Configuring Vehicle Density .....	196
5.9.14.3 Report Query .....	196
5.9.15 Main-sub Tracking.....	198
5.9.16 Video Quality Analytics.....	199
5.9.16.1 Configuring Video Quality Analytics.....	200
5.9.16.2 Analytics List.....	202
5.9.17 Entries Frequency.....	203
5.10 Alarm Settings.....	204
5.10.1 Alarm Information.....	204
5.10.2 Alarm Status .....	205
5.10.3 Alarm Input.....	206
5.10.4 Alarm Output.....	207
5.10.5 Video Detection .....	208
5.10.5.1 Motion Detection .....	209
5.10.5.2 Video Loss .....	209
5.10.5.3 Video Tampering .....	210
5.10.5.4 Scene Change.....	211

---



---

5.10.5.5 PIR Alarm.....	212
5.10.6 Audio Detection.....	214
5.10.7 Thermal Alarm.....	214
5.10.8 Exception.....	215
5.10.9 Disarming.....	217
5.11 Network.....	218
5.11.1 TCP/IP.....	218
5.11.2 Routing Table.....	222
5.11.3 Port.....	222
5.11.4 External Wi-Fi.....	224
5.11.5 Wi-Fi AP.....	225
5.11.5.1 General Settings.....	225
5.11.5.2 Advanced Settings.....	227
5.11.8 Repeater.....	228
5.11.9 PPPoE.....	231
5.11.10 DDNS.....	232
5.11.11 UPnP.....	233
5.11.11.1 Configuring Router.....	233
5.11.11.2 Configuring UPnP.....	233
5.11.12 Email.....	235
5.11.13 SNMP.....	237
5.11.14 Multicast.....	239
5.11.15 Alarm Center.....	240
5.11.16 Register.....	241
5.11.17 Switch.....	242
5.11.18 P2P.....	244
5.12 Storage.....	245
5.12.1 Basic.....	245
5.12.2 Disk Manager.....	246
5.12.3 RAnalytics+D.....	247
5.12.3.1 Creating RAnalytics+D.....	248
5.12.3.2 Viewing RAnalytics+D Information.....	250
5.12.3.3 Creating Hot Spare Disk.....	250
5.12.4 Disk Group.....	251
5.12.5 Disk Quota.....	252
5.12.6 Disk Check.....	253

---

5.12.6.1 Manual Check.....	253
5.12.6.2 Detection Report.....	254
5.12.6.3 Disk Health Monitoring .....	256
5.12.7 Record Estimate .....	257
5.12.7.1 Calculating Recording Time.....	259
5.12.7.2 Calculating HDD Capacity for Storage.....	259
5.12.8 FTP .....	260
5.12.9 iSCSI .....	262
5.13 Account .....	263
5.13.1 Group.....	264
5.13.2 User .....	265
5.13.2.1 Adding User.....	265
5.13.2.2 Changing Password .....	267
5.13.3 Resetting Password .....	268
5.13.3.1 Enabling Password Reset .....	268
5.13.3.2 Resetting Password on Local Interface.....	269
5.13.4 ONVIF User .....	274
5.14 Security.....	275
5.14.1 Security Status .....	275
5.14.2 System Service.....	277
5.14.2.1 Basic Services .....	277
5.14.2.2 802.1x .....	279
5.14.2.3 HTTPS.....	281
5.14.3 Attack Defense.....	281
5.14.3.1 Firewall .....	281
5.14.3.2 Account Lockout.....	283
5.14.3.3 Anti-DoS Attack .....	283
5.14.3.4 Sync Time-Allowlist.....	284
5.14.4 CA Certificate.....	285
5.14.4.1 Device Certificate .....	285
5.14.4.2 Trusted CA Certificate .....	288
5.14.5 Audio/Video Encryption.....	288
5.14.6 Security Warning .....	290
5.14.6.1 Security Exception.....	290
5.14.6.2 Illegal Login .....	290
5.15 System .....	291

---

5.15.1 General Settings .....	291
5.15.1.1 General.....	291
5.15.1.2 Date and Time.....	293
5.15.1.3 Holiday .....	295
5.15.2 Serial Port.....	297
5.16 Output and Display .....	298
5.16.1 Display.....	298
5.16.2 Tour .....	300
5.16.3 Custom Layout .....	302
5.17 POS.....	305
5.17.1 Settings.....	305
5.17.1.1 Privacy Setup.....	307
5.17.1.2 Connection Mode.....	307
5.17.2 Search.....	308
5.18 Audio .....	308
5.18.1 File Management.....	309
5.18.2 Audio Play .....	310
5.18.3 Broadcast.....	311
5.19 Operation and Maintenance.....	313
5.19.1 Log .....	313
5.19.2 System .....	314
5.19.2.1 System Version .....	314
5.19.2.2 Analytics+ Algorithm Version.....	315
5.19.2.3 HDD Info.....	315
5.19.2.4 BPS.....	316
5.19.2.5 Device Status .....	316
5.19.3 Network.....	317
5.19.3.1 Online User .....	317
5.19.3.2 Network Load .....	318
5.19.3.3 Network Test .....	319
5.19.4 Maintenance and Management.....	320
5.19.4.1 Device Maintenance.....	320
5.19.4.2 Exporting System Settings .....	321
5.19.4.3 Restoring Defaults .....	323
5.19.4.3.1 Restoring Defaults on the Local Interface.....	323
5.19.4.3.2 Resetting Device through the Reset Button .....	324

---

5.19.4.4 System Update .....	325
5.19.4.4.1 Upgrading File.....	325
5.19.4.4.2 Online Upgrade .....	326
5.19.4.4.3 Uboot Upgrading.....	327
5.19.4.5 Intelligent Diagnosis .....	327
5.20 USB Device Auto Pop-up.....	328
5.21 Shutdown.....	328
6 Web Operation .....	332
6.1 Network Connection .....	332
6.2 Web Login .....	332
6.3 Web Main Menu.....	333
6.4 Cluster Service .....	335
6.4.1 Configuring Cluster IP.....	336
6.4.2 Main Device.....	336
6.4.3 Sub Device.....	337
6.4.4 Transferring Videos.....	338
6.4.5 Configuring Cluster Control .....	338
6.4.5.1 Cluster Control.....	338
6.4.5.2 Arbitrage IP .....	339
6.4.6 Cluster Log.....	339
7 Glossary.....	340
8 FAQ .....	341
Appendix 1 HDD Capacity Calculation.....	346
Appendix 2 Mouse Operation.....	347
Appendix 3 Remote Control.....	348
Appendix 4 Compatible Network Camera List.....	351
Appendix 5 Cybersecurity Recommendations .....	358

# 1 Introduction

## 1.1 Overview

The NVR is a high performance network video recorder. This product supports local live view, multiple-window display, recorded file local storage, remote control and mouse shortcut menu operation, and remote management and control function.

This product supports center storage, front-end storage and client-end storage. The monitor zone in the front-end can be set in anywhere. Working with other front-end devices such as IPC, NVS, this series product can establish a strong security network through the CMS. In the network system, there is only one network cable from the monitor center to the monitor zone in the whole network. There is no audio/video cable from the monitor center to the monitor zone. The whole project is featured by simple connection, low-cost, low maintenance work.

## 1.2 Features

### Analytics+ Functions



Analytics+ functions are available on select models and vary with models.

- Face detection. The system can detect the faces are on the video image.
- Face Detection+. The system can compare the detected faces with the images in the face database in real time.
- Human body detection. The system activates alarm actions once human body is detected.
- People counting. The system can effectively count the number of people and flow direction.
- Heat map. The system can monitor the active objects in a specific area.
- Automatic number plate recognition (ANPR). The system can effectively monitor the passing vehicles.

### Smart Playback



This function is available on select models.

- IVS playback. It can screen out and replay the records meeting the set rules.
- Face detection playback. It can screen out and replay the records with human faces.
- Face Detection+ playback. It can compare the face information in the video with the information in the database and replay the corresponding records.

- ANPR playback. It can screen out the record with a specific car plate number or all the records with car plate numbers.
- Human body detection playback. It can screen out and replay the records with specific human bodies.
- Smart search. It includes smart functions such as searching by attribute and searching by image to enable users to get target records quickly.

## Real-Time Security

- VGA, HDMI port. Connect to monitor to realize real-time security. Some series support TV/VGA/HDMI output at the same time.
- Shortcut menu for preview.
- Support multiple popular PTZ decoder control protocols. Support preset, tour and pattern.

## Playback

- Support independent real-time recording for each channel. At the same time it supports functions such as smart search, forward play, network monitor, record search and download.
- Support various playback modes: slow play, fast play, backward play and frame-by-frame play.
- Support time title overlay so that you can view the event accurate occurred time.
- Support specified zone enlargement.

## User Management

Users can be added to user groups for management. Each group has a set of permissions that can be individually edited.

## Storage

- With corresponding settings (such as alarm settings and schedule settings), you can back up related audio/video data in the network video recorder.
- You can take records via the web and the record files are saved on the PC in which the client locates.

## Alarm

- Respond to external alarm simultaneously (within 200 ms). Based on user's pre-defined relay settings, the system can process the alarm input correctly and sends user screen or voice prompts (supporting pre-recorded audio).
- Support settings of the central alarm server, so that the system can automatically notify users of the alarm information. Alarm input can be derived from various connected peripheral devices.
- Alert you of alarm information via email.

## Network Security

- Send audio/video data compressed by IPC or NVS to client-ends through the network, and then the data will be decompressed and displayed.
- Support max 128 connections at the same time.
- Transmit audio/video data by protocols such as HTTP, TCP, UDP, MULTICAST and RTP/RTCP.
- Transmit some alarm data or alarm info by SNMP.
- Support web access in WAN/LAN.

## Window Split

Adopt video compression and digital processing to display several windows in one monitor. Support 1/4/8/9/16/25/36 window split in preview and 1/4/9/16 window split in playback.

## Record

Support regular record, motion record, alarm record and smart record. Save the recorded files in the HDD, USB device, client-end PC or network storage server and you can search or playback the saved files at the local-end or via the Web/USB devices.

## Backup

Support network backup and USB record backup. You can back up the record files in devices such as network storage server, peripheral USB 2.0 device and burner.

## Network Management

- Supervise NVR configuration and control power via Ethernet.
- Support web management.

## Peripheral Equipment Management

- Support peripheral device control and you can freely set the control protocol and connection port.
- Support transparent data transmission such as RS-232 and RS-485.

## Auxiliary

- Support switch between NTSC and PAL.
- Support real-time display of system resources information and running status.
- Support log record.
- Local GUI output. Shortcut menu operation with the mouse.
- IR control function (for some series only). Shortcut menu operation with remote control.
- Support to play the video/audio files from remote IPC or NVS.

## 2 Front Panel and Rear Panel



The following front panel and rear panel figures are for reference only.

### 2.1 Front Panel

#### 2.1.1 N41C1P/N41C2P



The figure is for reference only.

The N41C1P/N41C2P front panel is shown as below.

Figure 2-1 Front panel

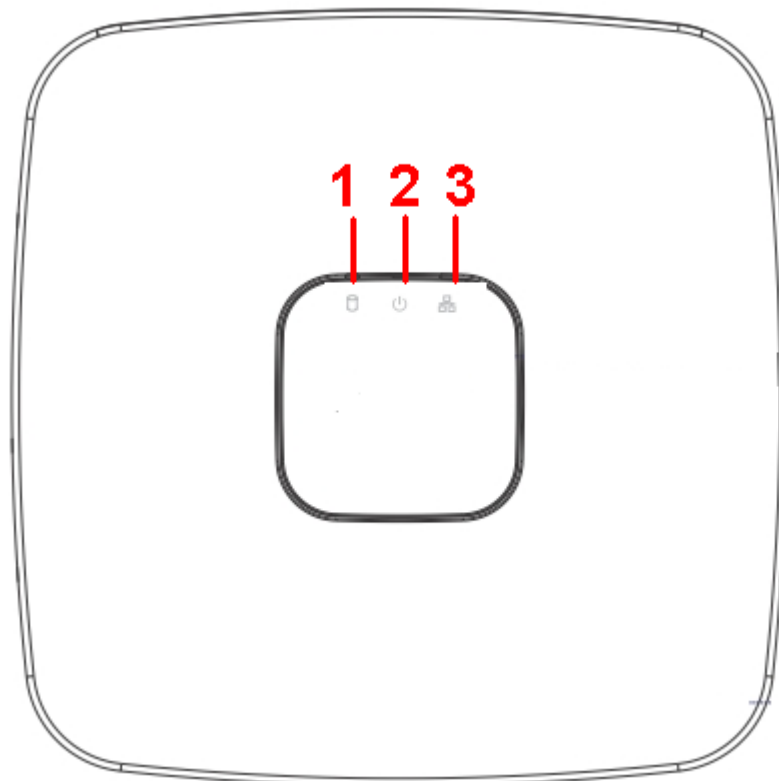

The N41C1P/N41C2P front panel is shown as below.



Figure 2-2 Front panel

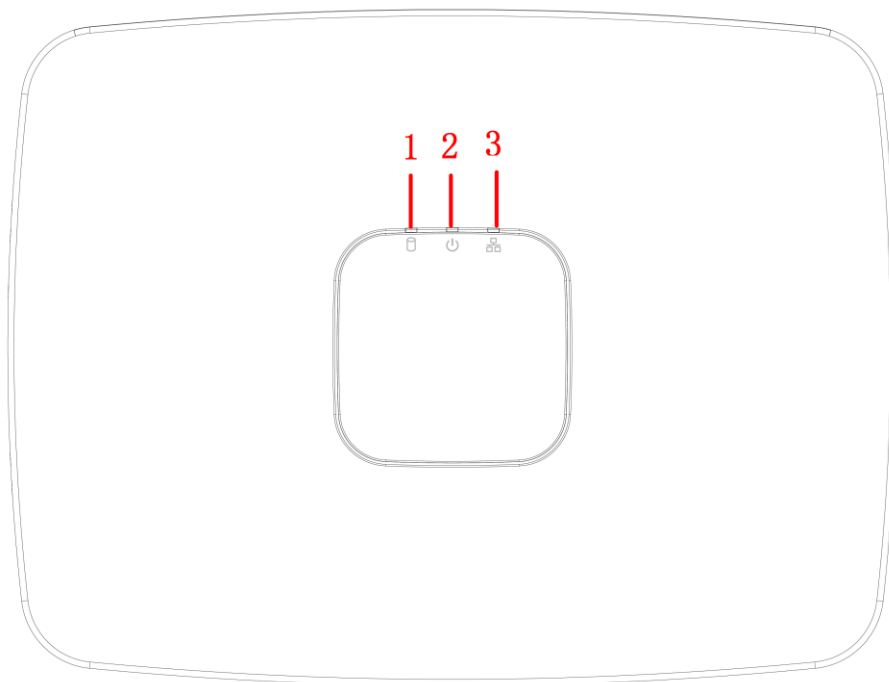

Table 2-1 Icons

No.	Name	Function
1	HDD status indicator light	The red light becomes on when HDD is abnormal.
2	Power indicator light	The red light becomes on when the power connection is normal.
3	Network status indicator light	The red light becomes on when the network connection is abnormal.



The figure is for reference only.

Figure 2-3 Front panel

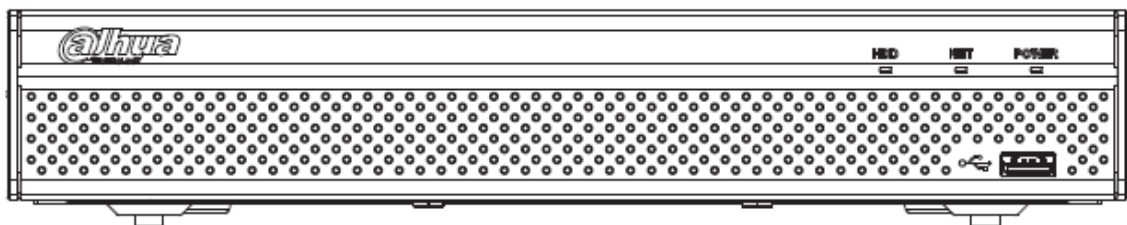



Table 2-2 Icons

Icon	Name	Function
HDD	HDD status indicator light	The blue light is on when the HDD is malfunction.
NET	Network status indicator light	The blue light is on when the network connection is abnormal.

Icon	Name	Function
POWER	Power status indicator light	The blue light is on when the power connection is OK.
	USB port	Connect to peripheral USB storage device, mouse and more.

## 2.1.2

### N42C1P/N42C2P/N42C3P/N52B5P/N54A4P/N54B3P/N54B5N



The figures are for reference only.

The N42C1P/N42C2P/N42C3P/N52B5P/N54A4P/N54B3P/N54B5N series front panel is shown as below.

Figure 2-4 Front panel

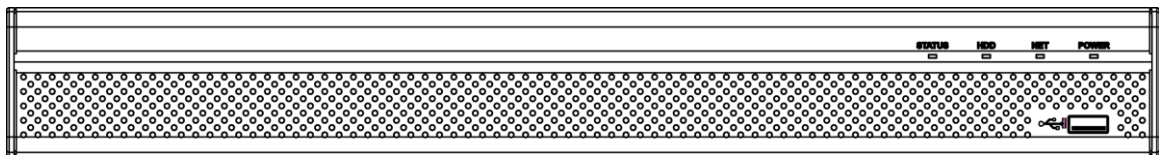

The N42C1P/N42C2P/N42C3P/N52B5P/N54A4P/N54B3P/N54B5N series front panel is shown as below.

Figure 2-5 Front panel

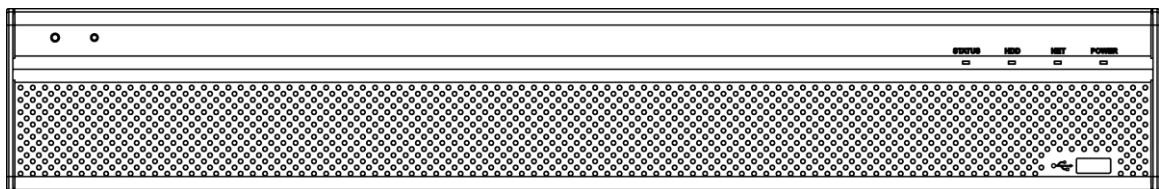

The N42C1P/N42C2P/N42C3P/N52B5P/N54A4P/N54B3P/N54B5N series front panel is shown as below

Figure 2-6 Front panel

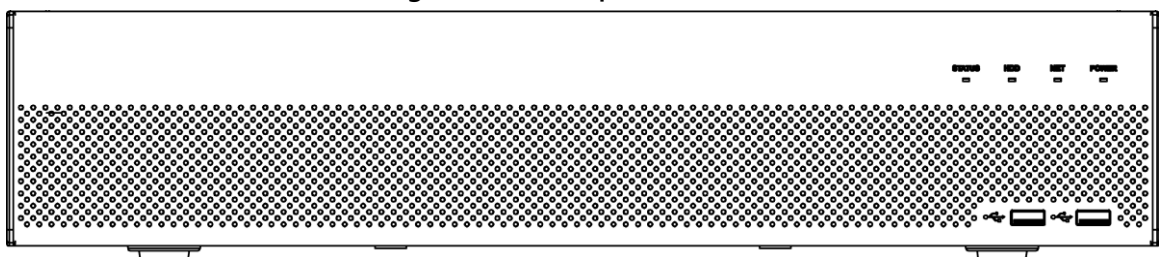



Table 2-3 Icons

Icon	Name	Function
STATUS	Status indicator light	The blue light is on when the Device is working properly.

Icon	Name	Function
HDD	HDD status indicator light	The blue light is on when the HDD malfunctions.
NET	Network status indicator light	The blue light is on when the network connection is abnormal.
POWER	Power status indicator light	The blue light is on when the power connection is normal.
	USB 2.0 port	Connect to peripheral USB 2.0 storage device, mouse, burner and more.

### 2.1.3 N82B2P/N82B3P/N82B5P



The figure is for reference only.

The NVR22-I/NVR22-I2 front panel is shown as below.

Figure 2-12 Front panel

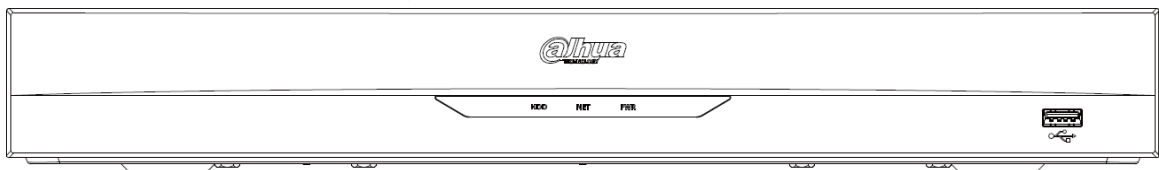

The NVR22-P-I/NVR22-P-I2 front panel is shown as below.

Figure 2-13 Front panel



The NVR22-8P-I/NVR22-8P-I2 front panel is shown as below.

Figure 2-14 Front panel

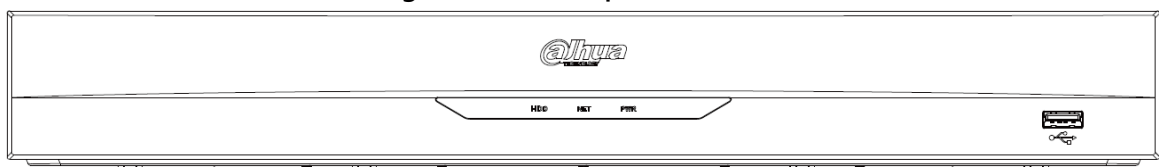

The NVR22-16P-I/NVR22-16P-I2 front panel is shown as below.

Figure 2-15 Front panel



The NVR52-EI/NVR52-8P-EI/NVR52-16P-EI front panel is shown as below.

Figure 2-16 Front panel

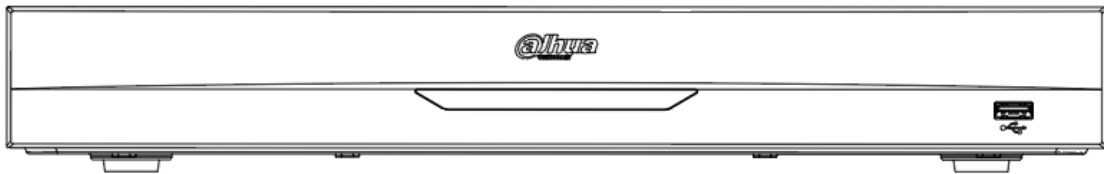



Table 2-6 Icons

Icon	Name	Function
HDD	HDD status indicator light	The blue light is on when the HDD malfunctions.
NET	Network status indicator light	The blue light is on when the network connection is abnormal.
PWR	Power status indicator light	The blue light is on when the power connection is OK.
	USB 2.0 port	Connect to peripheral USB 2.0 storage device, mouse, burner and more.

## 2.1.4 N84B3P/N84B3N/N84B5N



The figures are for reference only.

The N84B3P/N84B3N/N84B5N series front panel is shown as below.

Figure 2-20 Front panel

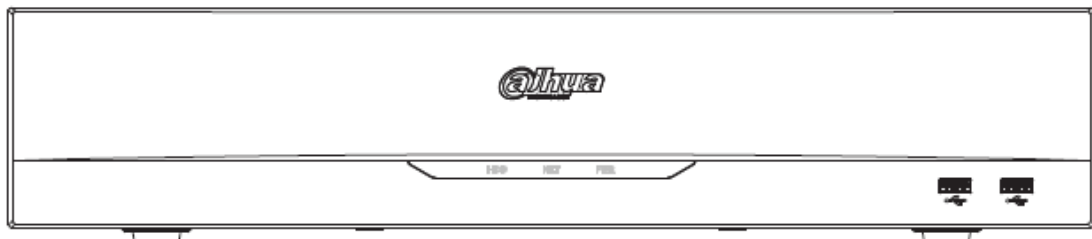

The N84B3P/N84B3N/N84B5N front panel is shown as below.

Figure 2-21 Front panel



The N84B3P/N84B3N/N84B5N front panel is shown as below.

Figure 2-22 Front panel

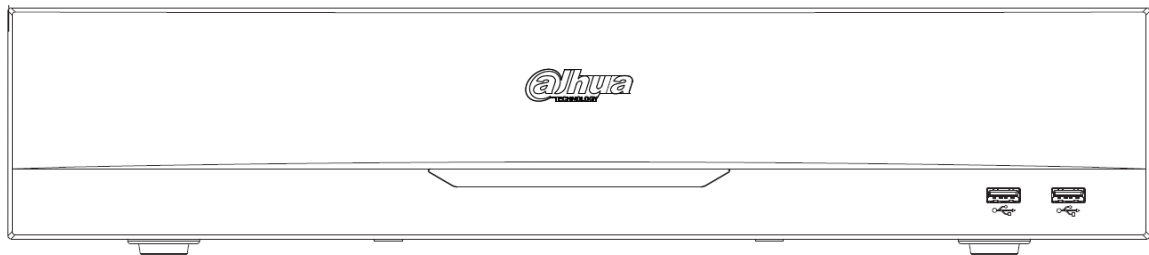



Table 2-10 Icons

Icon	Name	Function
HDD	HDD status indicator light	The blue light is on when the HDD malfunctions.
NET	Network status indicator light	The blue light is on when the network connection is abnormal.
PWR	Power status indicator light	The blue light is on when the power connection is normal.
	USB 2.0 port	Connect to peripheral USB 2.0 storage device, mouse, burner and more.

## 2.1.5 N98A5N/N98A6N/N98A7N

The N98A5N/N98A6N/N98A7N front panel is shown as below.

Figure 2-24 Front panel

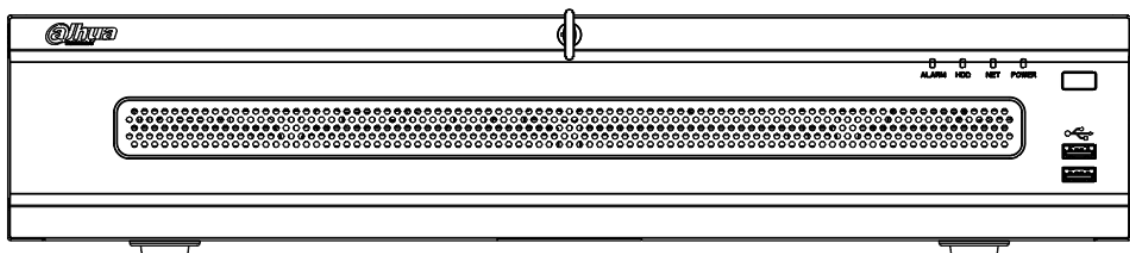



Table 2-12 Front panel description

Icon	Name
ALARM	Alarm indicator light
HDD	HDD status indicator light
NET	Network status indicator light
POWER	Power status indicator light
	USB 2.0 port

Icon	Name
	<p>Power on-off button</p>

## 2.2 Rear Panel

### 2.2.1 N41C1P/N41C2P

The N41C1P/N41C2P series rear panel is shown as below.

Figure 2-55 Rear panel

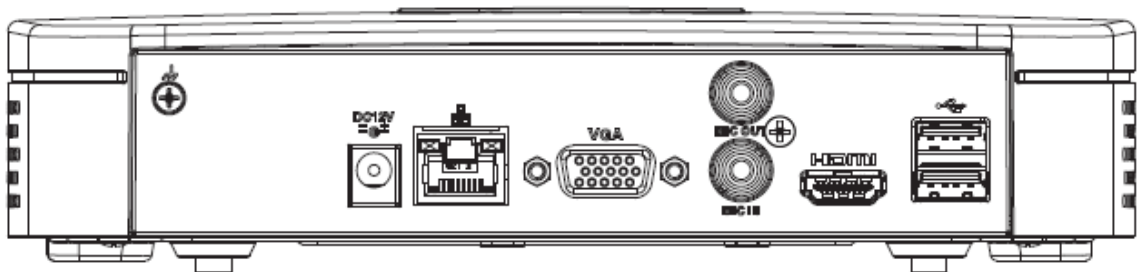

The N41C1P/N41C2P series rear panel is shown as below.

Figure 2-56 Rear panel

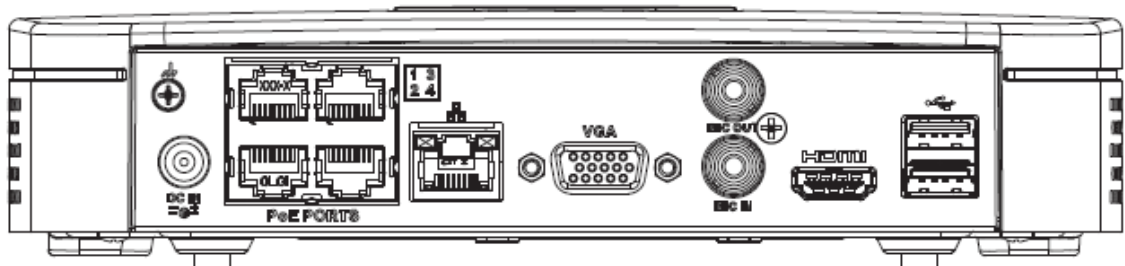

The N41C1P/N41C2P series rear panel is shown as below.

Figure 2-57

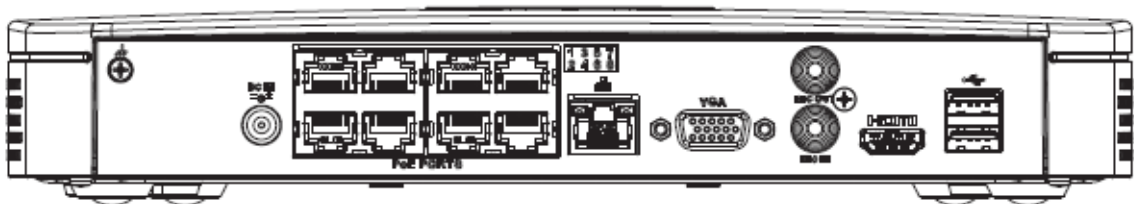





Table 2-20 Ports

Port Name	Connection	Function
	USB port	USB port. Connect to mouse, USB storage device, USB burner and more.
	Network port	10/100 Mbps self-adaptive Ethernet port. Connect to the network cable.
HDMI	High Definition Media Interface	High definition audio and video signal output port. It transmits uncompressed high definition video and multiple-channel data to the HDMI port of the display device. HDMI version is 1.4.
VGA	VGA video output port	VGA video output port. Output analog video signal. It can connect to the monitor to view analog video.
	GND	Ground end.
	Power input port	Power socket. <ul style="list-style-type: none"> <li>• For N41C1P/N41C2P: 12 VDC/2 A power.</li> <li>• For NVR41-P-4KS2: 48 VDC/72 W power.</li> <li>• For NVR41-8P-4KS2: 48 VDC/96 W power.</li> </ul>
MIC IN	Audio input port	Bidirectional talk input port. It is to receive the analog audio signal output from the devices such as microphone, pickup.
MIC OUT	Audio output port	Audio output port. It is to output the analog audio signal to the devices such as the sound box. <ul style="list-style-type: none"> <li>• Bidirectional talk output.</li> <li>• Audio output on 1-window video monitor.</li> <li>• Audio output on 1-window video playback.</li> </ul>
PoE PORTS	PoE port	Built-in switch. Support PoE function. For PoE series product, you can use this port to provide power to the network camera.

## 2.2.2

### N42C1P/N42C2P/N42C3P/N52B5P/N54A4P/N54B3P/N54B5N

The N42C1P series rear panel is shown as below.

Figure 2-58 Rear panel

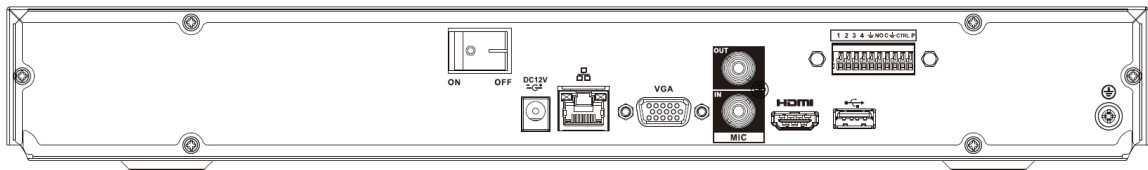

The N42C1P series rear panel is shown as below.

Figure 2-59 Rear panel

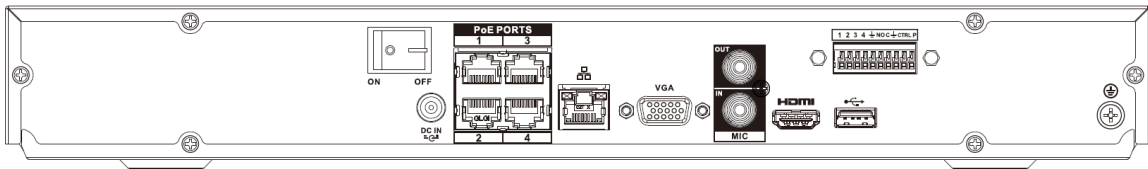

The N42C2P series rear panel is shown as below.

Figure 2-60 Rear panel

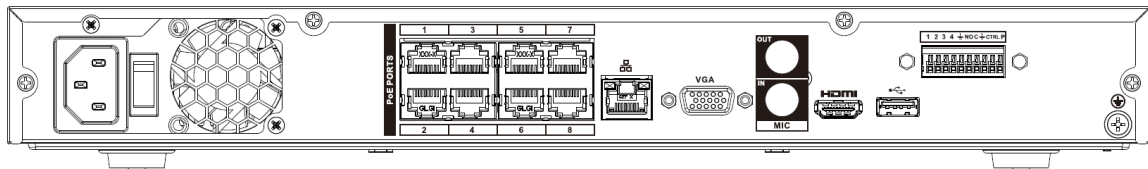

The N42C3P series rear panel is shown as below.

Figure 2-61 Rear panel

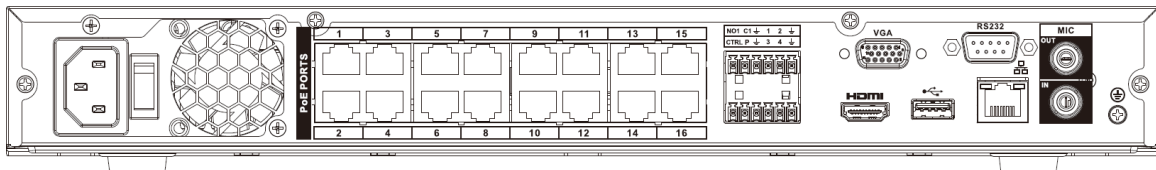





Table 2-21 Rear panel description

Name		Function
	Power switch	Power on/off button.
		Input 12 VDC/4 A. For NVR42-4KS2 series product only.
	Power input port	Switch power port. Input 48 VDC/96 W. For NVR42-P-4KS2 series product only.
		Input 90~264-12 VAC 5 A/52 V 2.5 A-190 W. For NVR42-8P-4KS2/NVR42-16P-4KS24K 1U (S2) with 8 PoE ports/ 4K 1U (S2) with 16 PoE ports series product only.
MIC IN	Audio input port	Bidirectional talk input port. It is to receive the analog audio signal output from the devices such as microphone, pickup.



Name		Function
MIC OUT	Audio output port	Audio output port. It is to output the analog audio signal to the devices such as the sound box. <ul style="list-style-type: none"> <li>• Bidirectional talk output.</li> <li>• Audio output on 1-window video monitor.</li> <li>• Audio output on 1-window video playback.</li> </ul>
1-4	Alarm input port 1-4	<ul style="list-style-type: none"> <li>• There are two types; NO (normal open)/NC (normal close).</li> <li>• When your alarm input device is using external power, please make sure the device and the NVR have the same ground.</li> </ul>
	GND	Alarm input ground port.
N1, N2	Alarm output port 1-2	<ul style="list-style-type: none"> <li>• 2 groups of alarm output ports. (Group 1: port NO1-C1, Group 2: port NO2-C2). Output alarm signal to the alarm device. Please make sure there is power to the external alarm device.</li> <li>• NO: Normal open alarm output port.</li> <li>• C: Alarm output public end.</li> </ul>
C1, C2		
A	RS-485 communication port	RS485_A port. It is the cable A. You can connect to the control devices such as speed dome PTZ.
B		RS485_B. It is the cable B. You can connect to the control devices such as speed dome PTZ.
	Network port	10/100/1000 Mbps self-adaptive Ethernet port. Connect to the network cable.
	USB port	USB port. Connect to mouse, USB storage device, USB burner and more.
RS-232	RS-232 debug COM	It is for general COM debug to configure IP address or transfer transparent COM data.
HDMI	High Definition Media Interface	High definition audio and video signal output port. It transmits uncompressed high definition video and multiple-channel data to the HDMI port of the display device. HDMI version is 1.4.
VGA	VGA video output port	VGA video output port. Output analog video signal. It can connect to the monitor to view analog video.
PoE PORTS	/	Built-in Switch. Support PoE. For PoE series product, you can use this port to provide power to the network camera.

## 2.3 Alarm Connection

### 2.3.1 Alarm Port

The alarm port is shown as below. The following figure is for reference only.

Figure 2-97 Alarm port

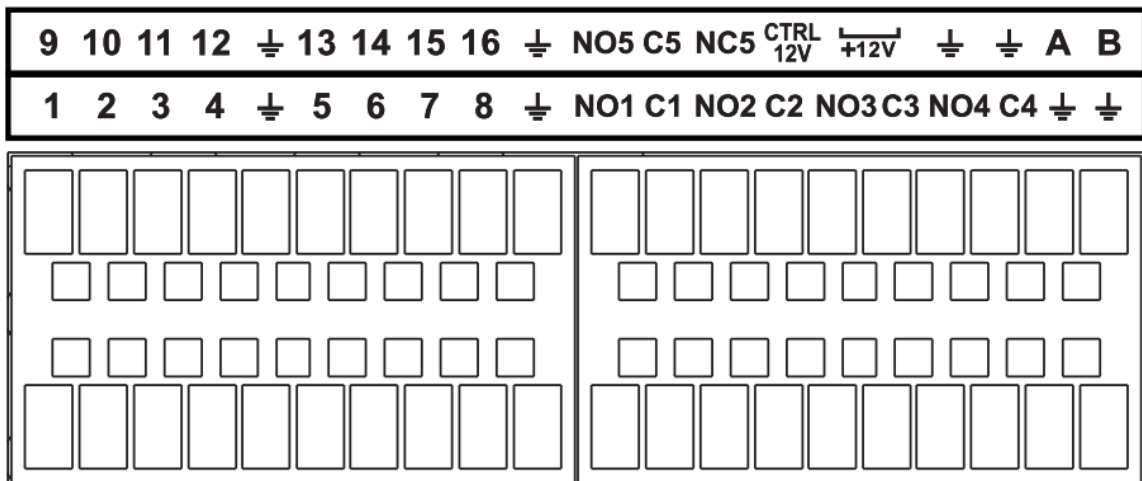

Table 2-45 Alarm port description

Icon	Function
1-16	ALARM1-ALARM16. The alarm becomes activated in the low level.
NO1 C1, NO2 C2, NO3 C3, NO4 C4	Four NO activation output groups. (On-off button).
NO5 C5 NC5	One NO/NC activation output group. (On-off button).
CTRL (CTRL 12 V)	Control power output. Disable power output when alarm is canceled. Current is 500 mA.
P (+12 V)	Rated current output. Current is 500 mA.
⏏	GND.
A/B	485 communication port. They are used to control devices such as PTZ. Please parallel connect 120 TΩ between A/B cables if there are too many PTZ decoders.



- Different models support different alarm input ports. Please see the specifications sheet for detailed information.
- Slight difference might be found on the alarm port layout.

### 2.3.2 Alarm Input Port

Connect the positive end (+) of the alarm input device to the alarm input port (ALARM IN 1-

16) of the NVR. Connect the negative end (-) of the alarm input device to the ground end

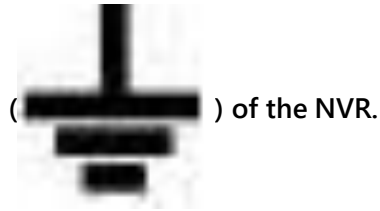

Figure 2-98 Alarm input port (1)

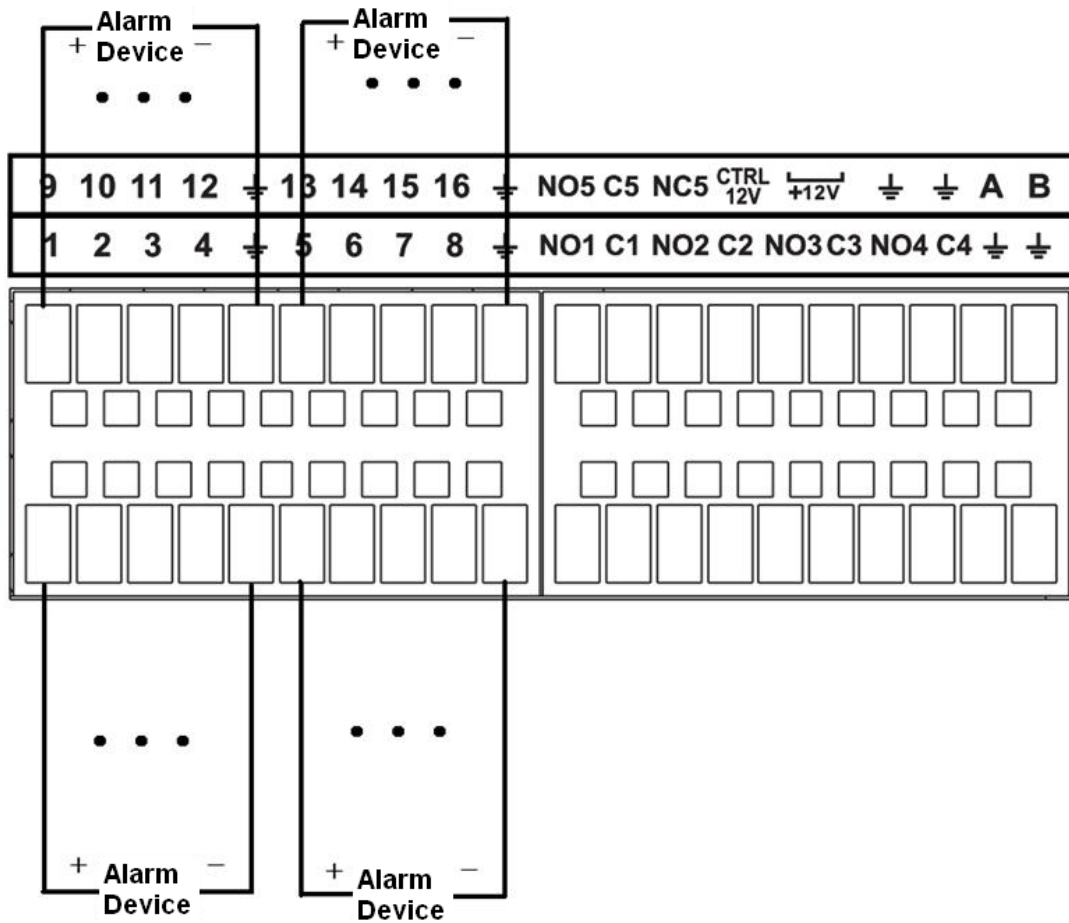
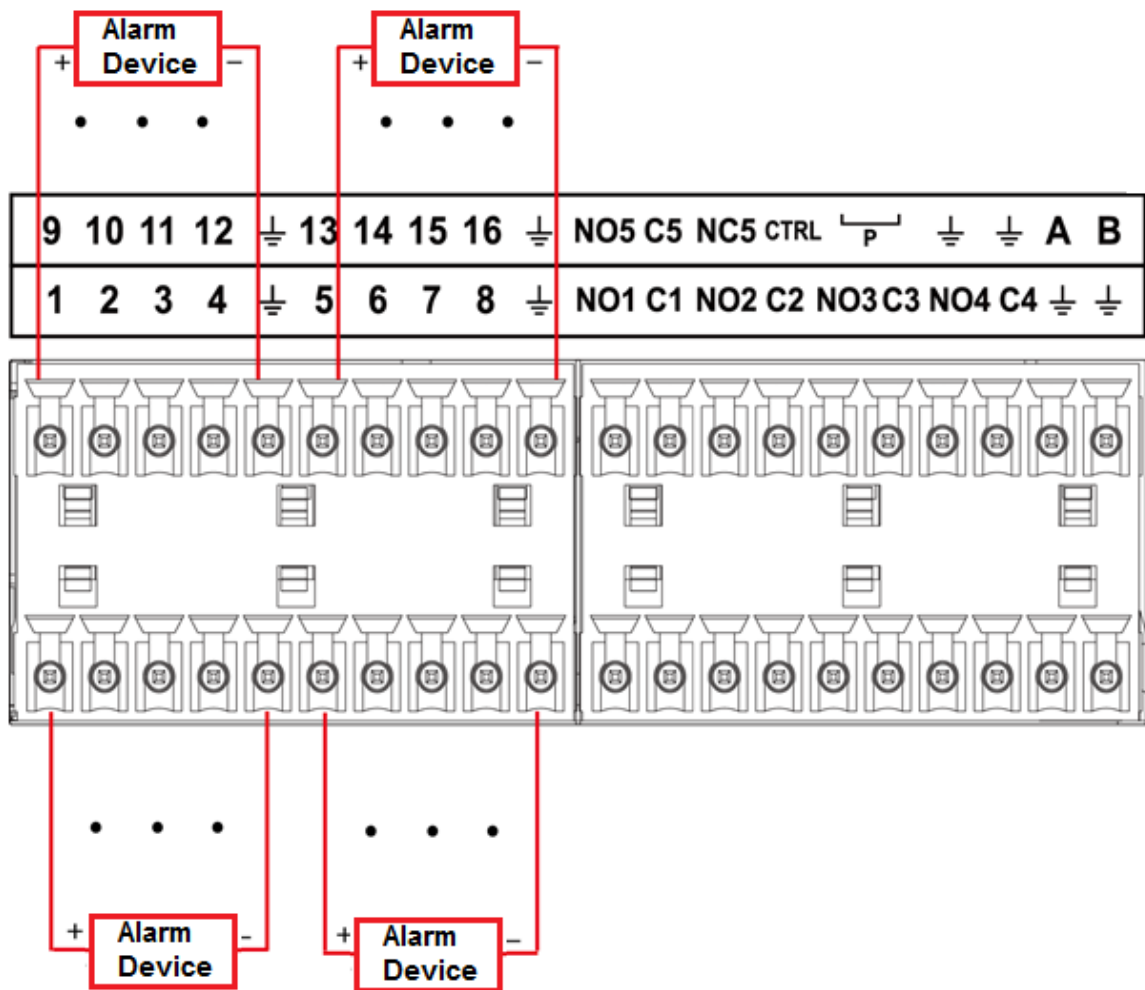

Figure 2-99 Alarm input port (2)



- There are two alarm input types: NO/NC.
- When connect the ground port of the alarm device to the NVR, you can use any of the



- Connect the NC port of the alarm device to the alarm input port (ALARM) of the NVR.
- When there is peripheral power supplying for the alarm device, please make sure it is earthed with the NVR.

### 2.3.3 Alarm Output Port

- There is peripheral power supplying for the external alarm device.
- In case overload might result in NVR damage, please see the following relay specifications for detailed information.
- A/B cable of the RS-485 is for the A/B cable connection of the speed PTZ.

## 2.3.4 Alarm Relay Specifications

Table 2-46 Alarm relay specifications

Model: JRC-27F		
Material of the touch	Silver	
Rating (Resistance Load)	Rated switch capacity	30 VDC 2 A, 125 VAC 1 A
	Maximum switch power	125 VAC, 160 W
	Maximum switch voltage	250 VAC, 220 VDC
	Maximum switch current	1 A
Insulation	Between touches with same polarity	1000 VAC 1 minute
	Between touches with different polarity	1000 VAC 1 minute
	Between touch and winding	1000 VAC 1 minute
Surge voltage	Between touches with same polarity	1500 V (10×160 μs)
Length of open time	3 ms max	
Length of close time	3 ms max	
Longevity	Mechanical	50 × 10 <sup>6</sup> MIN (3 Hz)
	Electrical	200 × 10 <sup>3</sup> MIN (0.5 Hz)
Temperature	-40 °C to +70 °C	

## 2.4 Two-way Talk

### 2.4.1 Device-end to PC-end

#### Procedure

- Step 1** Connect the speaker or the pickup to the first audio input port on the device rear panel.
- Step 2** Connect the earphone or the sound box to the audio output port in the PC.
- Step 3** Log in to the web and then enable the corresponding channel real-time monitor.
- Step 4** Enable two-way talk.

Figure 2-100 Enable two-way talk

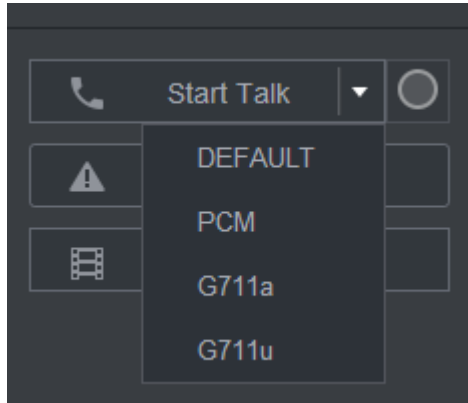

**Step 5** At the device end, speak by the speaker or the pickup, and then you can get the audio from the earphone or sound box at the PC end.

Figure 2-101 Device to PC

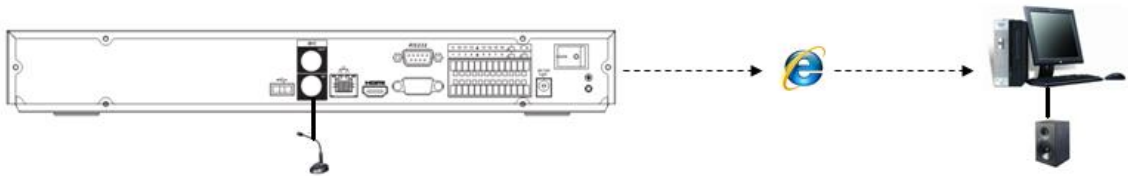

## 2.4.2 PC-end to the Device-end

### Device Connection

1. Connect the speaker or the pickup to the audio output port in the PC.
2. Connect the earphone or the sound box to the first audio input port in the device rear panel.
3. Log in to the web and then enable the corresponding channel real-time monitor.
4. Enable bidirectional talk. See Figure 2-100.

### Listening Operation

At the PC-end, speak by the speaker or the pickup, and then you can get the audio from the earphone or sound box at the device-end.

Figure 2-102 PC to device

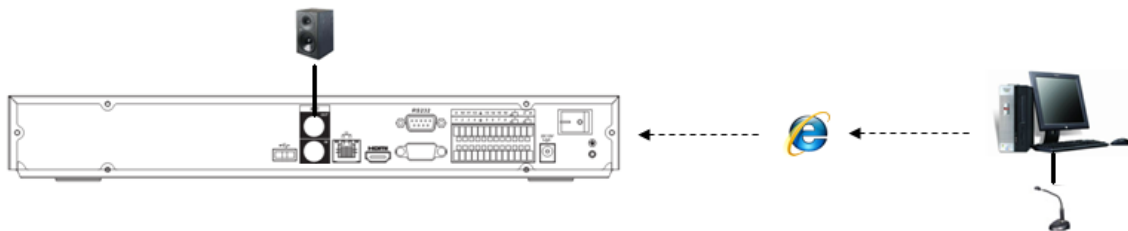

## 3 Device Installation



All the installation and operations here should conform to your local electric safety rules.

### 3.1 Device Installation Diagram

Please see the following diagram to install the NVR.

Figure 3-1 Installation flowchart

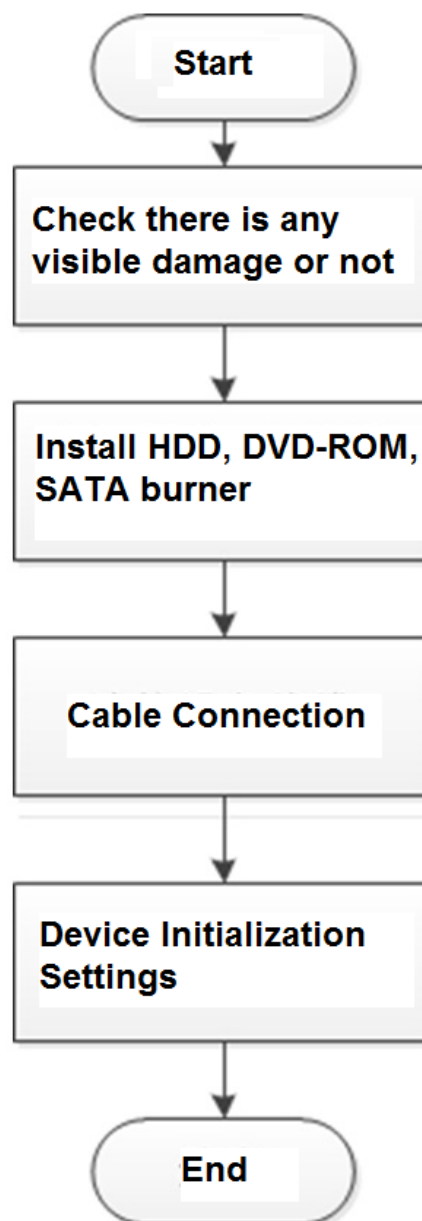

## 3.2 Checking Unpacked NVR

When you receive the NVR, check against the following checklist. If any of the items are missing or damaged, contact the local retailer or after-sales service immediately.

Table 3-1 Checklist

Sequence	Item	Description	
1	Overall packaging	Appearance	No obvious damage.
		Package	Not distorted or broken.
		Accessories	Nothing missing.
2	The Device	Appearance	No obvious damage.
		Model	The model description is consistent with the contract.
		Label	Not torn up.  Keep the label well. You need to provide the serial number on the label when calling the after-sales service.

## 3.3 HDD Installation

For the first time installation, make sure whether the HDD has been installed or not. We recommend to use HDD of enterprise level or security level. It is not recommended to use PC HDD.



- Shut off the power before you replace the HDD.
- Use the dedicated SATA HDD for monitoring recommended by the HDD manufacturer.
- You can see the Appendix for HDD space information and recommended HDD brand.

### 3.3.1 N41C1P/N41C2P

#### Background Information



Connect cable and then secure the HDD on the NVR if it is not convenient to connect the HDD data cable and power cable at first.

#### Procedure

- Step 1** Loosen the screws of the bottom of the chassis.



Figure 3-2 Lossen screws

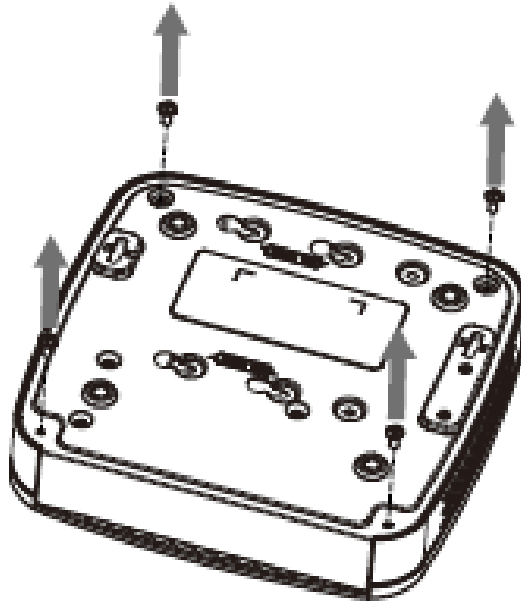

**Step 2** Place the HDD in accordance with the four holes in the bottom.

Figure 3-3 Aligh HDD



**Step 3** Turn the device upside down and then secure the screws firmly.

Figure 3-4 Secure screws

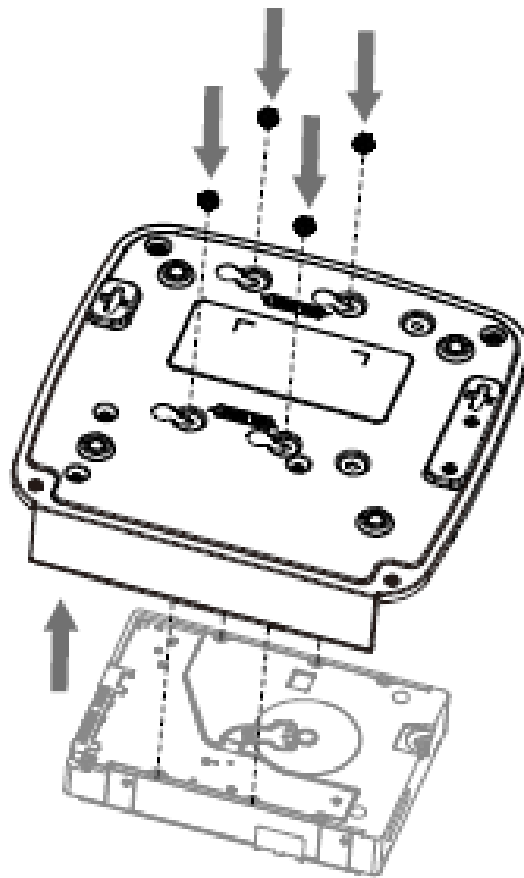

**Step 4** Connect the HDD cable and power cable to the HDD and the mainboard respectively.

Figure 3-5 Connect cables

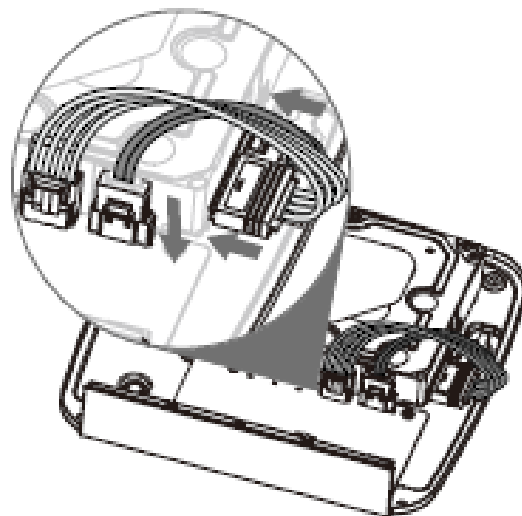

**Step 5** Put the cover back and then fix the screws of the rear panel. The installation is complete.

Figure 3-6 Put back the cover

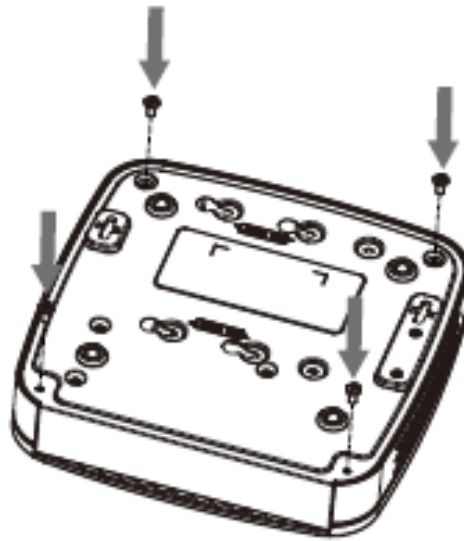

## 3.4 CD-ROM Installation

### Procedure

Step 1 Open the top cover and then remove the HDD bracket.

Figure 3-37 Open the top cover



Step 2 Take off the bottom of the HDD bracket and CD-ROM bracket.

Figure 3-38 Take out HDD bracket



Figure 3-39 Take out CD-ROM bracket



**Step 3** Fix the CD-ROM bracket at the HDD bracket.

Figure 3-40 Fix bracket



**Step 4** Install a pair of the CD-ROM bracket. Please make sure that the reverse side is secure too.

Figure 3-41 Install bracket



Figure 3-42 Install bracket (reverse side)



**Step 5** Install SATA burner. Line up the SATA burner to the hole positions.

Figure 3-43 Install SATA burner



**Step 6** Use screw driver to fix the screws.

Figure 3-44 Fasten screws



**Step 7** Put the bracket back. Please adjust the CD-ROM to the proper position so that the button of the front panel is directly facing the pop-up button of the CD-ROM.

Figure 3-45 Put bracket back



**Step 8** Connect the SATA cable and power wire.

Figure 3-46 Connect cables

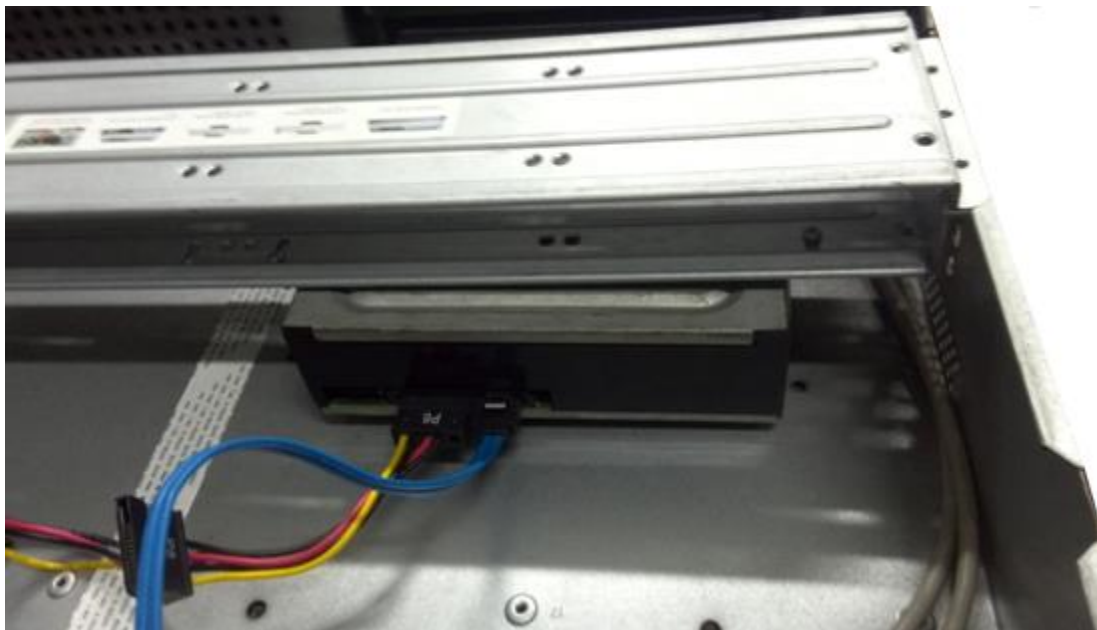

**Step 9** Secure the HDD bracket and put the top cover back.

Figure 3-47 Put cover back



## 3.5 Connection Sample



The following figures are for reference only and might differ from the actual product.

### 3.5.1 N41C1P/N41C2P

Figure 3-48 Typical connection

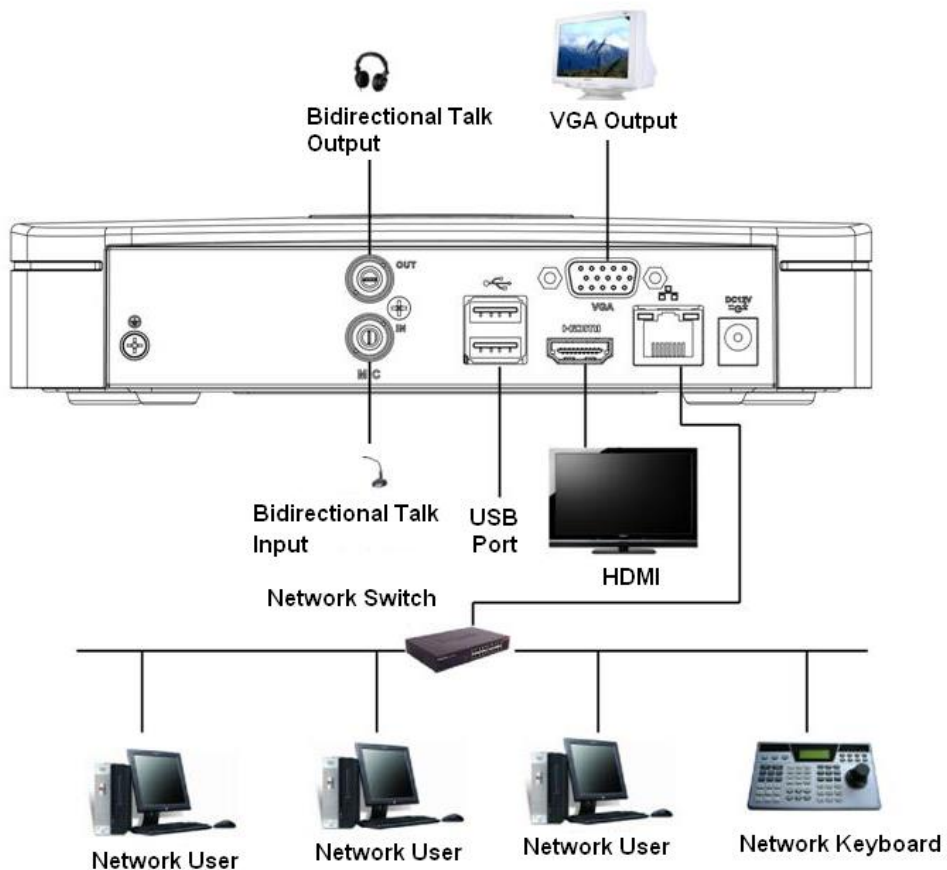

### 3.5.2

## N42C1P/N42C2P/N42C3P/N52B5P/N54A4P/N54B3P/N54B5N

Figure 3-52 Typical connection

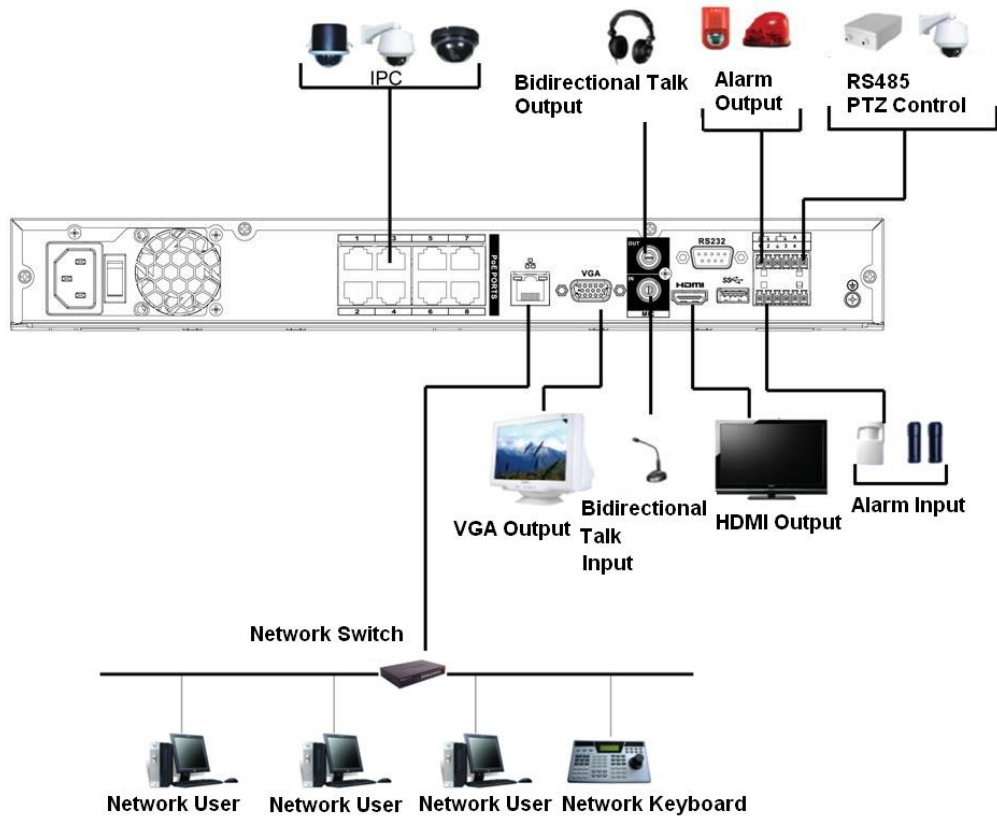



### 3.5.3

## N42C1P/N42C2P/N42C3P/N52B5P/N54A4P/N54B3P/N54B5N

Figure 3-53 Typical connection

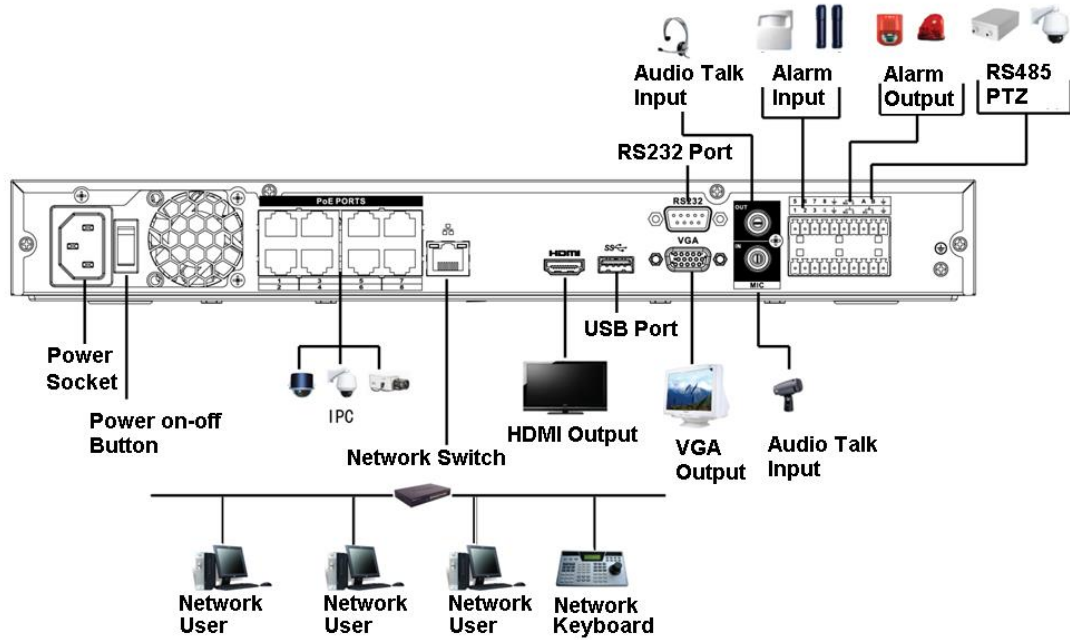

## 4 Starting the Device

### Background Information



- For device security, connect the NVR to the power adapter first and then connect the device to the power socket.
- The rated input voltage matches the device power button. Make sure the power wire connection is OK. Then press the power button.
- Always use the stable current, if necessary UPS is a best alternative measure.

### Procedure

Step 1 Connect the device to the monitor and then connect a mouse.

Step 2 Connect power cable.

Step 3 Press the power button on the front panel or turn on the power switch on the rear panel to start up the device.

After the device starts, the system is in multiple-channel display mode by default.



The Device will verify license during starting up. If the verification failed, the icon



is displayed on the screen. Contact the technical support.

## 5 Local Operations



The following figures are for reference only. Slight difference might be found on the actual interface.

### 5.1 Initialization

#### Background Information

- For first-time use, set a login password for the admin account (default user).
- We recommend setting password protection so that you can reset password in case you forgot.



- For your device safety, keep your login password well, and change the password regularly.
- The IP address of the Device is 192.168.1.108 by default.

#### Procedure

**Step 1** Start the NVR.

**Step 2** Set region, time zone, and time according to the actual situation, and then click Next.



Click  to shut down the device. The system integrator or the user can shut down the Device directly after setting the time zone.

**Step 3** Set the login password for the admin account and then click Next.

Figure 5-1 Set password

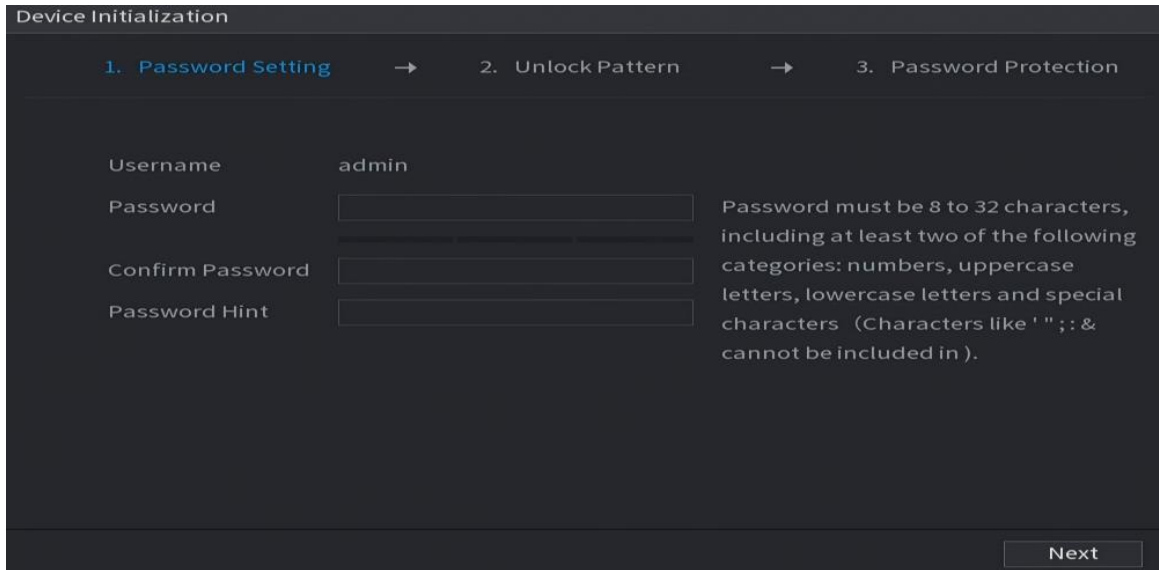

Device Initialization

1. Password Setting → 2. Unlock Pattern → 3. Password Protection

Username: admin

Password:



Confirm Password:

Password Hint:

Password must be 8 to 32 characters, including at least two of the following categories: numbers, uppercase letters, lowercase letters and special characters (Characters like ' ; : & cannot be included in ).

Next

Table 5-1 Password parameters

Parameter	Description
User	By default, the user is admin.
Password	Enter the password for admin and then confirm the password.
Confirm Password	
Password Hint	Enter the information that can remind you of the password.  On the login window, click  to display the password hint.

**Step 4** Set unlock pattern.



- The pattern that you want to set must cross at least four points.
- If you do not want to configure the unlock pattern, click Skip.
- Once you have configured the unlock pattern, the system will require the unlock pattern as the default login method. If you did not configure the unlock pattern, you need to enter password for login.

Figure 5-2 Draw unlock pattern

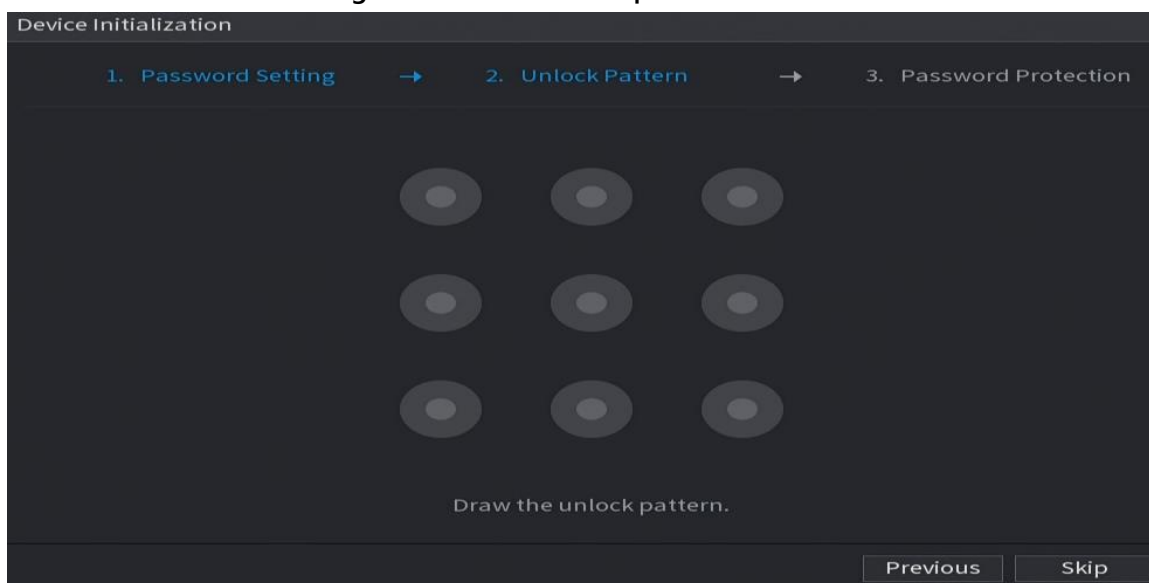

**Step 5** Set password protection.

- After configuration, if you forgot the password for admin user, you can reset the password through the linked email address or security questions. For details on resetting the password, see "5.13.3 Resetting Password".
- If you do not need password protection, disable Reserved Email and Security Question.

Figure 5-3 Set password protection

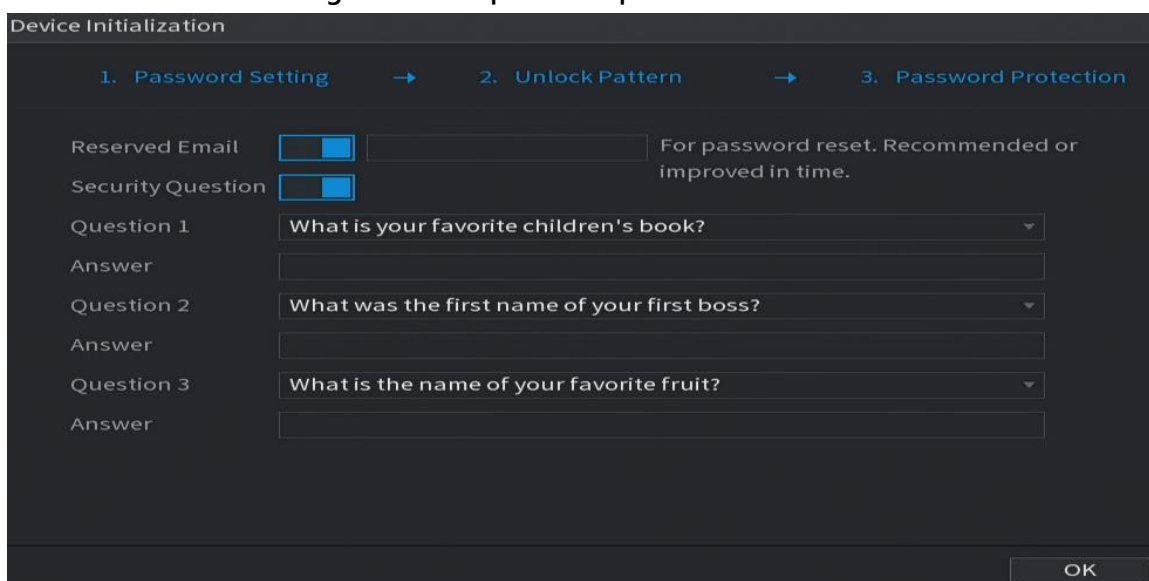

Table 5-2 Security question parameters

Password Protection Mode	Description
Email Address	Enter the linked email address. Enter an email address for password reset. If you forgot the password, enter the security code that you will get from this linked email address to reset the password of admin.
Security Questions	Configure the security questions and answers. If you forgot the password, you can reset the password after entering the answers to the questions.

**Step 6** Click Save.

## 5.2 Startup Wizard

### Background Information

After initialization, the system goes to Startup Wizard. You can quickly configure your device.



Startup Wizard is displayed only when you log in to the Device for the first time or have restored the Device to factory settings.

### Procedure

**Step 1** Select Auto Check for Updates, and then click Next.

If you select the Auto Check for Updates checkbox, the system will notify you automatically when updates are available.

Figure 5-4 Startup wizard

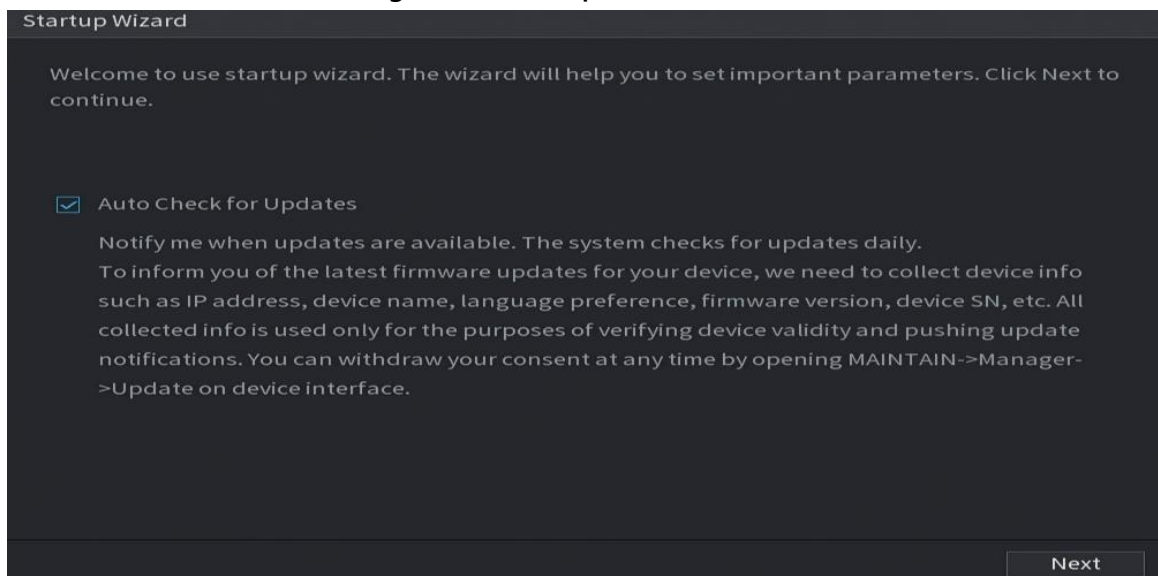

**Step 2** Configure IP address, and then click Next.



The number of network adapters might vary with models. Configure the IP address of the network adapter according to the actual connection situation.

- 1) Click

Figure 5-5 Edit network adapter

NIC Name	IP Address	Network ...	NIC Member	Modify	Unbind
NIC1			1		





IP Address: 17... Default Gateway: 1... MTU: 1500  
 MAC Address: ... Subnet Mask: 255.255.0.0 Mode: Static

IP Version: IPv4  DHCP  
 Preferred DNS: ...  
 Alternate DNS: ...  
 Default Card: NIC1

- 2) Configure parameters.

Table 5-3 Network parameters

Parameter	Description
Network Mode	<ul style="list-style-type: none"> <li>• Single NIC: Two network adapters work separately. If one</li> </ul>

Parameter	Description
Default Ethernet Port	<p>of the two network adapters is disconnected, the system network status is regarded as offline.</p> <ul style="list-style-type: none"> <li> <b>Fault Tolerance</b>                      : Two network adapters share one IP address. Normally only one network adapter is working. When this adapter fails, the other network adapter will start working automatically to ensure the network connection.  <ul style="list-style-type: none"> <li>◇ When you test the network status, the network is regarded as offline only when both network adapters are disconnected.</li> <li>◇ The two network adapters are used under the same LAN.</li> </ul> </li> <li> <b>Load Balance</b>                      : Two network adapters share one IP address. The two adapters work at the same time to share the network load averagely. If one of them fails, the other can continue working normally.  <ul style="list-style-type: none"> <li>◇ When testing the network status, the network is regarded as offline only when both of the two network adapters are disconnected.</li> <li>◇ The two network adapters are used under the same LAN.</li> </ul> </li> </ul> <p> The Device with single Ethernet port does not support this function.</p>
IP Version	Select IPv4 or IPv6. Both versions are supported for access.
DHCP	Enable the system to automatically obtain a dynamic IP address.
MAC Address	Displays the MAC address of the Device.
IP Address	<ul style="list-style-type: none"> <li>• Enter the IP address and then configure the corresponding subnet mask and default gateway.</li> <li>• After configuration, click Test to check whether there is conflict in IP address.</li> </ul> <p> IP address and default gateway must be on the same network segment.</p>
Subnet Mask	
Default Gateway	





To unbind NIC, on the TCP/IP page, click . The unbinding will take effect after the Device restarts.

3) On the TCP/IP page, configure DNS server. This step should be performed when you enable the domain name service.

You can get DNS server address or manually enter it.

- Automatically get DNS server address: When there is a DHCP server in the network, you can enable DHCP, and then the Device gets a dynamic IP address.
- Enter DNS server address: Select IP Version, and then configure the preferred DNS server and alternate DNS server.

4) On the Default Card drop-down list, select the default NIC.

5) Click Next.

**Step 3** Enable P2P, and then click Next.

Scan the QR code on the actual interface to download the app. Register an account and then you can add the Device to the app.



Before using the P2P function, make sure that the NVR has connected to the WAN. The Status becomes Online after you successfully configure P2P.

Figure 5-6 P2P

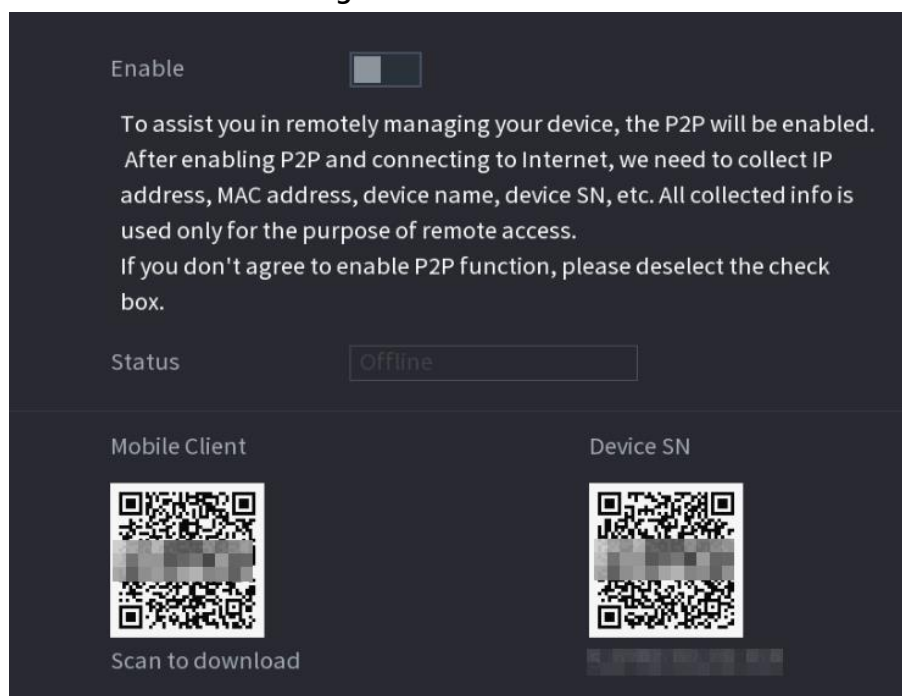

**Step 4** Add cameras according to the actual situation.

After adding cameras, you can view the video images transmitted from the cameras, and change camera configuration.



- The number of cameras that can be added to the NVR varies with models.
- The system supports adding camera through searching, manual add and batch add. This section uses adding by searching as an example.
- Initialize the camera before adding to the Device.

1) Click Search Device.

The devices found are displayed at the upper pane, excluding devices already added.

Figure 5-7 Search device

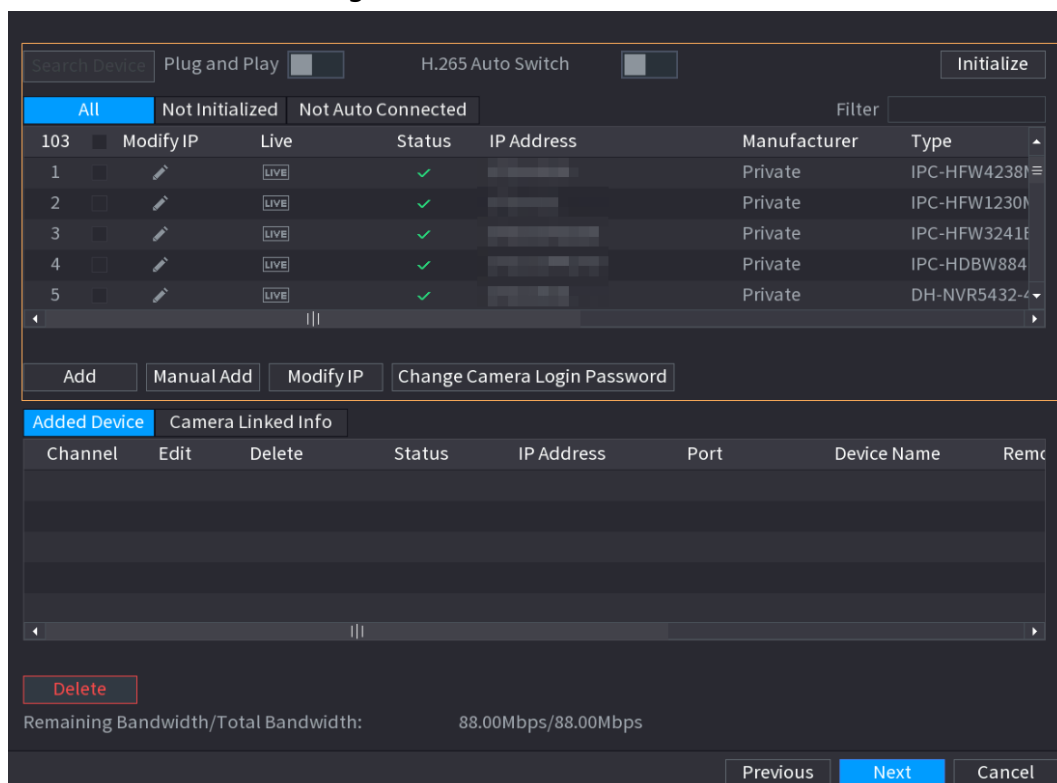

- To view the live image of a camera, click LIVE and then enter the username and password. You can only view live images of cameras accessed through private protocol.
- To filter the remote devices, select device name from the Filter drop-down list.
- To filter out the uninitialized devices, click the Not Initialized tab, and then you can initialize the devices remotely.
- To view all remote devices added through plug and play, click the Not Auto Connected tab. You can remove devices added through plug and play, and they can be automatically added again after plug and play is enabled.

2) (Optional) Enable Plug and Play.

When Plug and Play is enabled, the Device automatically adds cameras on the same LAN.



For uninitialized cameras, the Device automatically initializes them before adding them.

3) Enable H.265 Auto Switch

When H.265 Auto Switch is enabled, the video compression standard of added remote devices is switched to H.265 automatically.

4) Double-click a camera, or select a camera and then click Add to register it to the Added Device list.

5) Click Next.

**Step 5** Manage HDD. You can view HDD name, physical position, health status, capacity, and more.



- To configure read/write property, select an option from the Properties drop-down list.
- To format an HDD, select the HDD, and then click Format.

Figure 5-8 Manage HDD

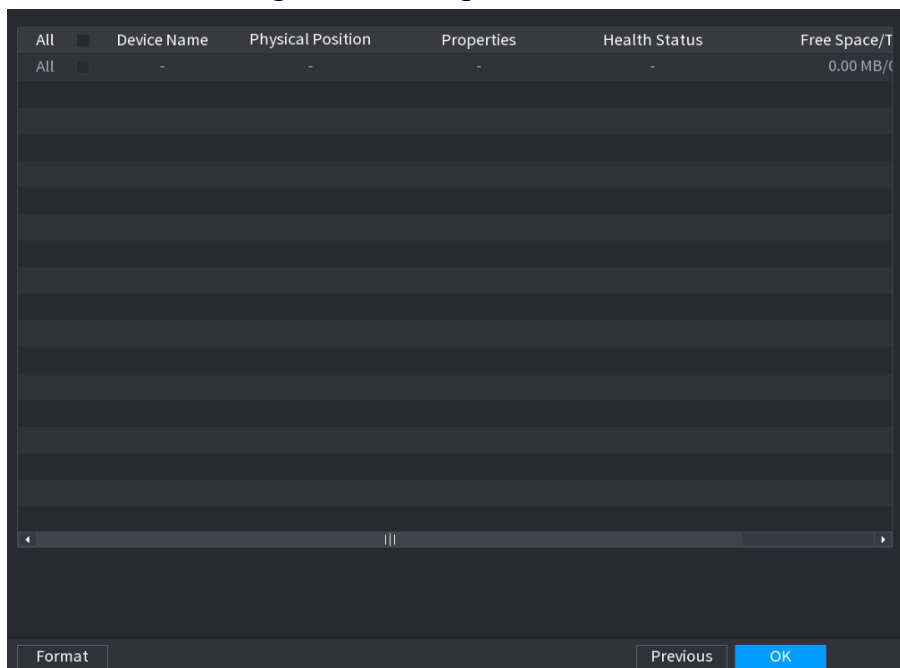

**Step 6** Click OK.

When the Device prompts whether to restart, click OK. The configurations through startup wizard take effect after the Device restarts.

## 5.3 Login

### Background Information

Log in to the Device to perform local operations.

## Procedure

- Step 1 Right-click the live page, and then click the shortcut menu.
- If you have configured unlock pattern, the unlock pattern login window is displayed. Click **Forgot Pattern** to switch to password login.
  - If you did not configure unlock pattern, the password login window is displayed.

Figure 5-9 Unlock pattern login

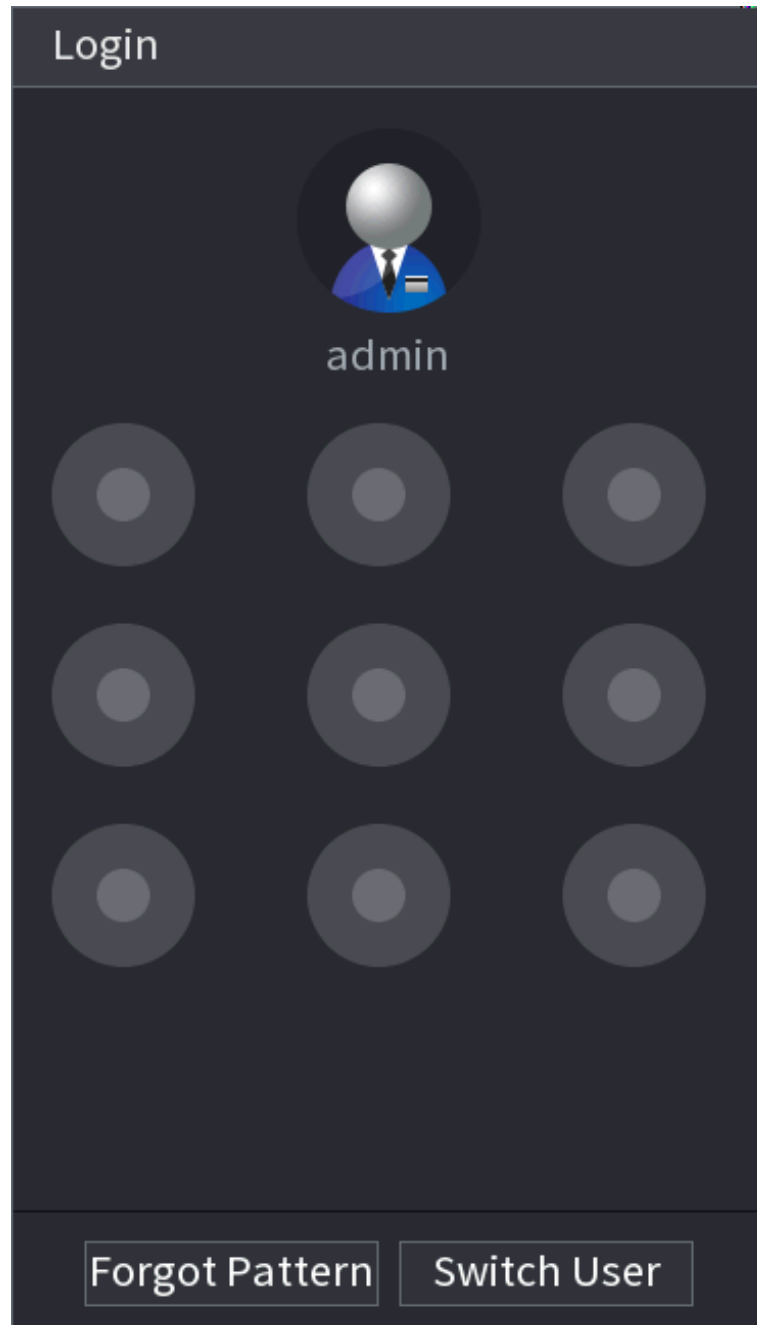
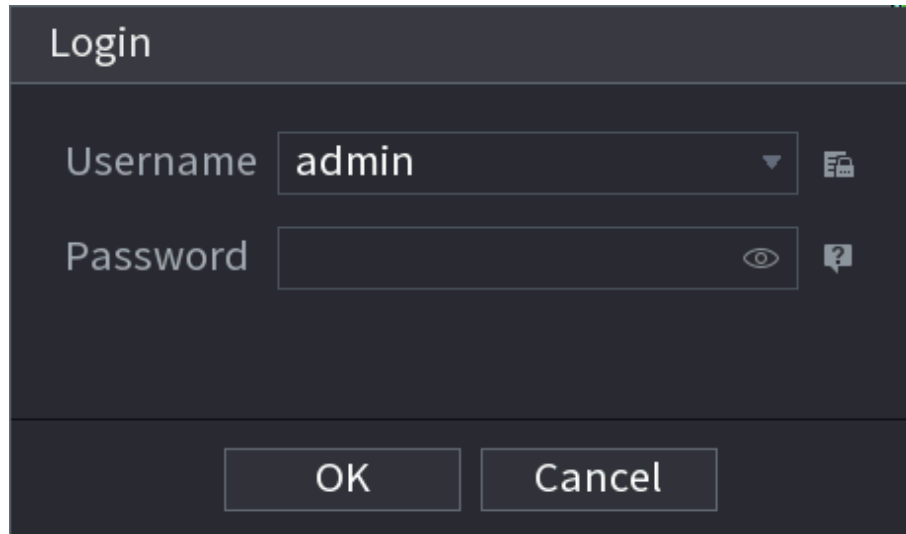

Figure 5-10 Password login

A dark-themed login dialog box titled "Login". It contains two input fields: "Username" with the text "admin" and a dropdown arrow, and "Password" which is currently empty. To the right of the "Username" field is a lock icon, and to the right of the "Password" field is an eye icon. Below the input fields are two buttons: "OK" and "Cancel".

Login

Username admin

Password

OK Cancel

Step 2 Draw unlock pattern, or enter password and then click OK.

## 5.4 Main Menu

After login, right-click the live page, and then click Main Menu.

Figure 5-11 Main menu

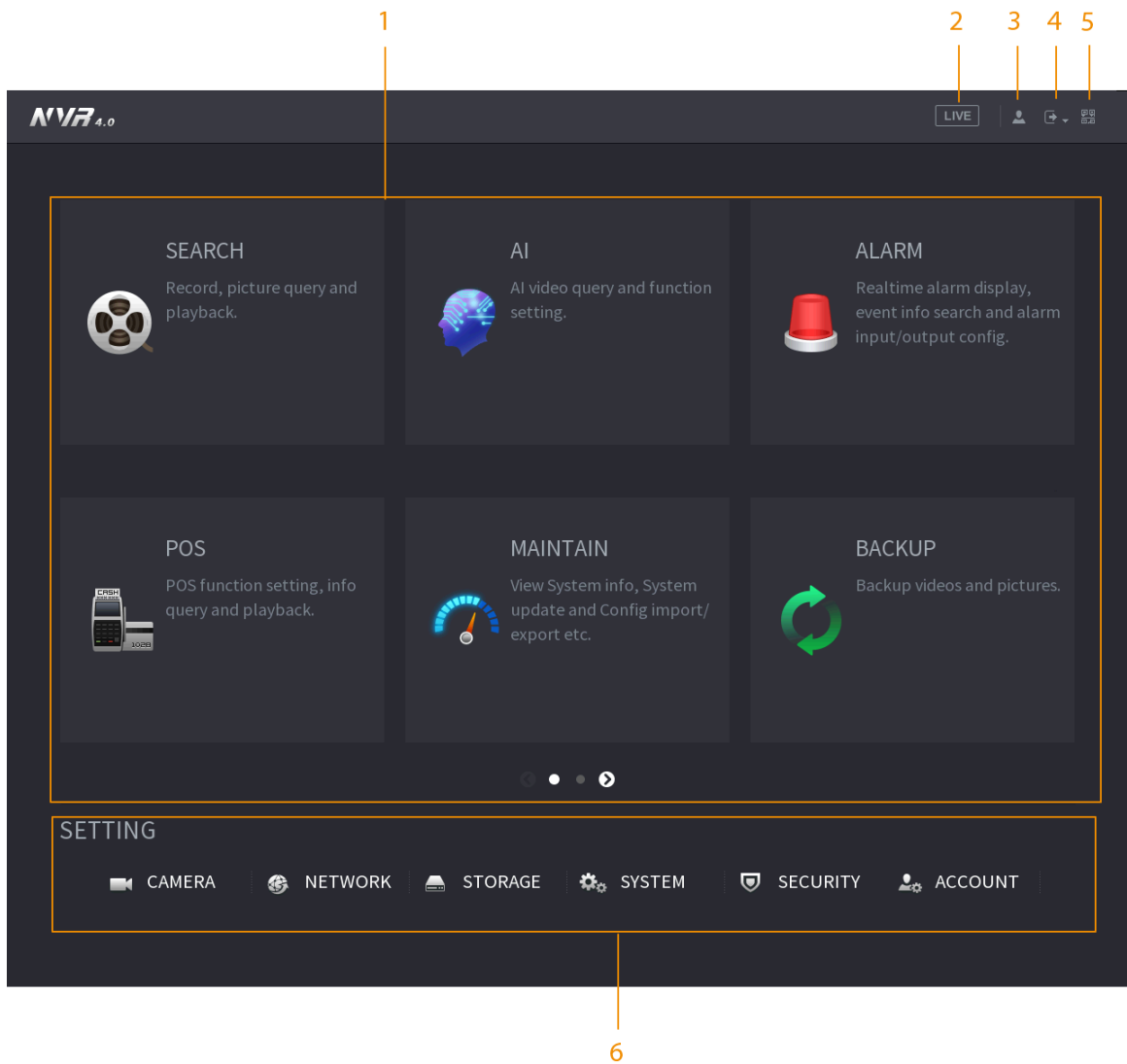

Table 5-4 Main menu description

No.	Description
1	Click each tile to open the corresponding configuration page.
2	Go back to live view.
3	Point to the icon to view the current username.
4	Log out of, restart, or shut down the Device.
5	Click the icon to get the QR codes of mobile client and device SN. You can add the Device to the mobile client for remote management.
6	Configure the settings of camera, network, storage, system, security and account.

## 5.5 Quick Operation Bar

You can click the icons on the main menu to go to the corresponding configuration page. After that, you can go to other function tiles or setting item through the quick operation bar. This section uses ALARM and CAMERA as examples to show how to quickly access other modules.

### Shortcut Icons on Function Titles

Click ALARM to go to the ALARM page.

Figure 5-12 Quick operation bar (1)

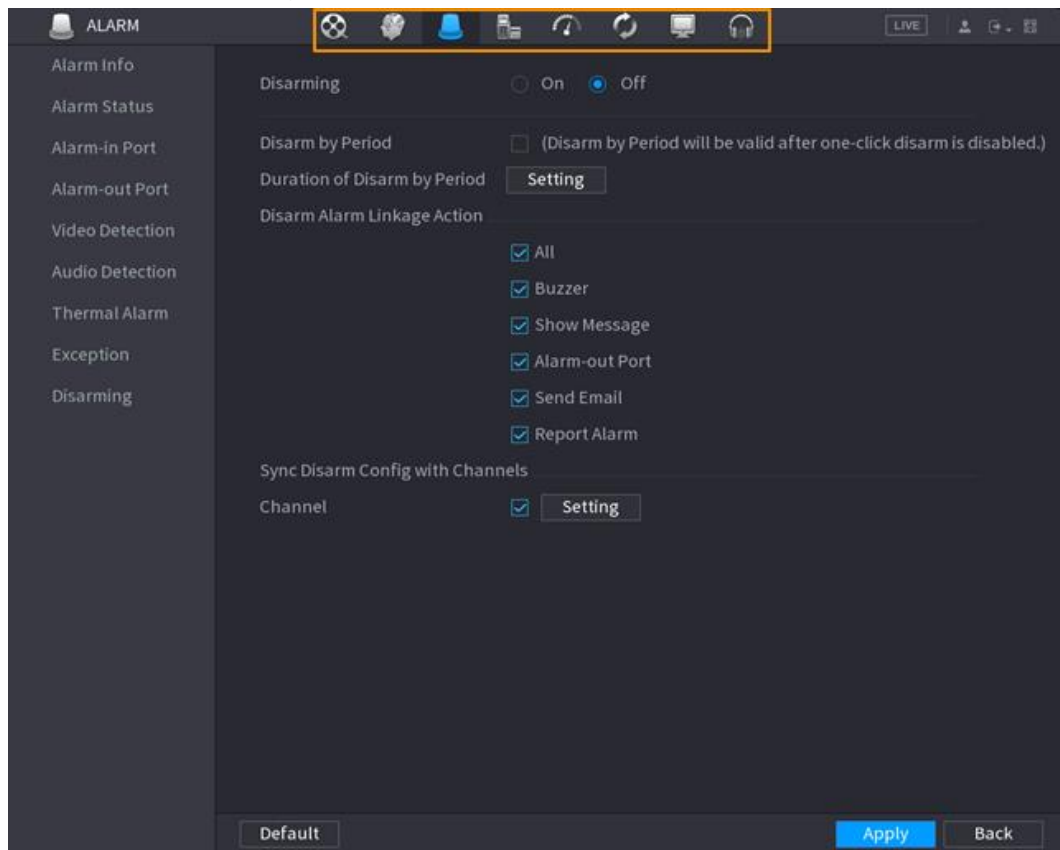

Table 5-5 Quick operation bar description (1)

Icon	Description
	Go to the SEARCH page.
	Go to the ALARM page.
	Go to the Analytics+ page.
	Go to the POS page.
	Go to NETWORK page.
	Go to the MAnalytics+NTAnalytics+N page.
	Go to the BACKUP page.
	Go to the DISPLAY page.

Icon	Description
	Go to the AUDIO page.

## Shortcut Icons on Setting Menu

Click CAMERA to go to the CAMERA page.

Figure 5-13 Quick operation bar (2)

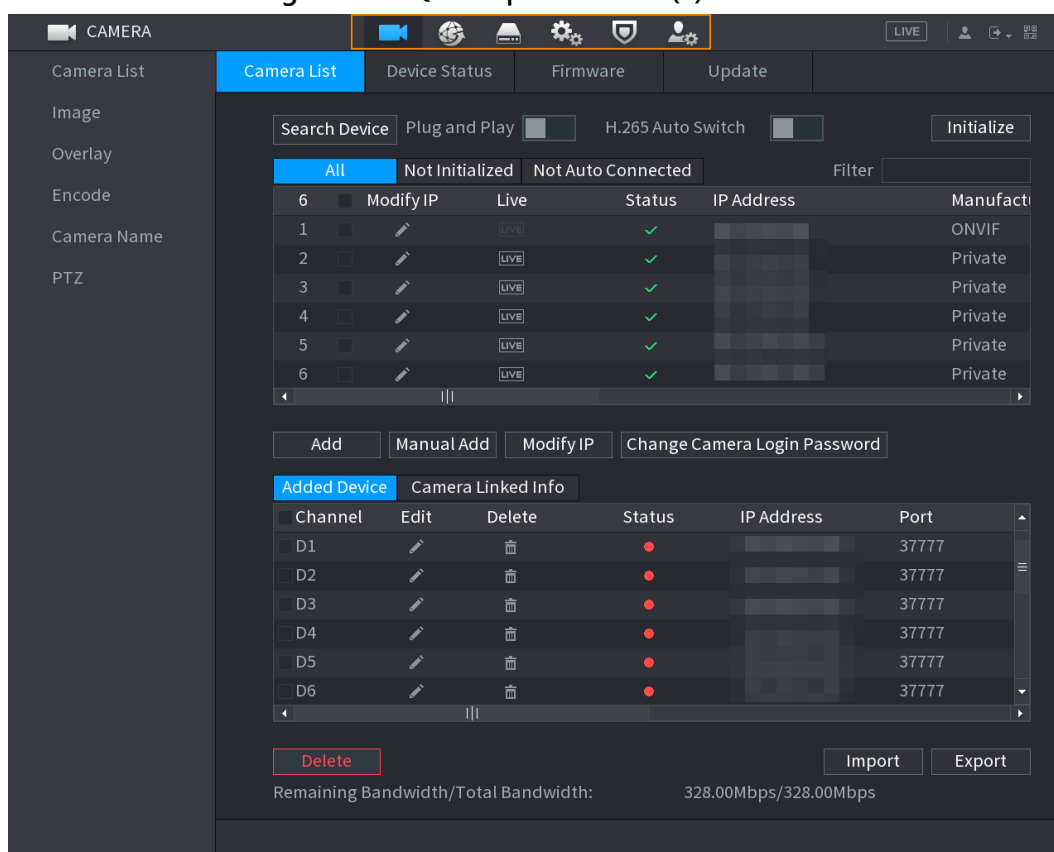

Table 5-6 Quick operation bar description (2)

Icon	Description
	Go to the CAMERA page.
	Go to the NETWORK page.
	Go to the STORAGE page.
	Go to the SYSTEM page.
	Go to the SECURITY page.
	Go to the ACCOUNT page.

## 5.6 Live View

After you logged in, the system goes to multiple-channel live view mode by default. You can view the live video of each channel.





The number of window splits might vary depending on the model you are using.

## 5.6.1 Live Page

On the live view page, you can view the live video of each channel. The corresponding channel displays date, time, and channel name after you overlay the corresponding information.

Table 5-7 Icon description

No.	Icon	Description
1		The current channel is recording.
2		Motion detection alarm occurs.
3		Video loss alarm occurs.
4		The current channel is in monitor lock status.
5		The Device connects to the network camera remotely.  This function is available on select models.

## 5.6.2 Navigation bar

### Background Information

You can quickly perform operations through the icons on the navigation bar.



The navigation bar might vary with models.

### Procedure



















- Step 1** After login, right-click the live page, and then select Main Menu.
- Step 2** Select System > General > Basic.
- Step 3** Click to enable navigation bar.
- Step 4** On the live page, click any position and then the navigation appears at the bottom.

Figure 5-14 Navigation bar



Table 5-8 Navigation bar description

Icon	Function
	Open Main Menu.
	Expand or condense the navigation bar.

Icon	Function
	Select view layout.
	Go to the previous screen.
	Go to the next screen.
	Enable tour function. The icon switches to  .  If you close the tour or the triggered tour operation has canceled, the Device restores the previous preview video.
	Open the PTZ control panel. For details, see "5.6.7.2 PTZ Control".
	Configure image settings. For details, see "5.7.4 Configuring Image Settings".  This function is supported only in single-channel layout.
	Search for records. For detail, see "5.8.2.1 Search Page".
	Open the Voice Broadcast page. For detail, see "5.18.3 Broadcast".
	Open the Alarm Status interface to view the device alarm status. For details, see "5.10.2 Alarm Status".
	Open the Channel Info interface to display the information of each channel.
	Open the Add Camera page..
	Open the NETWORK page. For details, see "5.19.3 Network".
	Open the Disk Manager page. For details, see "5.12.2 Disk Manager".
	Open the USB Management page. You can view USB information, back up files, and update the system.
	Switch to the sub screen.

### 5.6.3 Live View Control Bar

Point to the top center of the video of current channel; and then the live view control bar appears.

If your mouse stays in this area for more than 6 seconds and has no operation, the control bar automatically hides.



- Disable the navigation bar before using this function.
- The live view control bar is different depending on the model.

Figure 5-15 Live view control bar

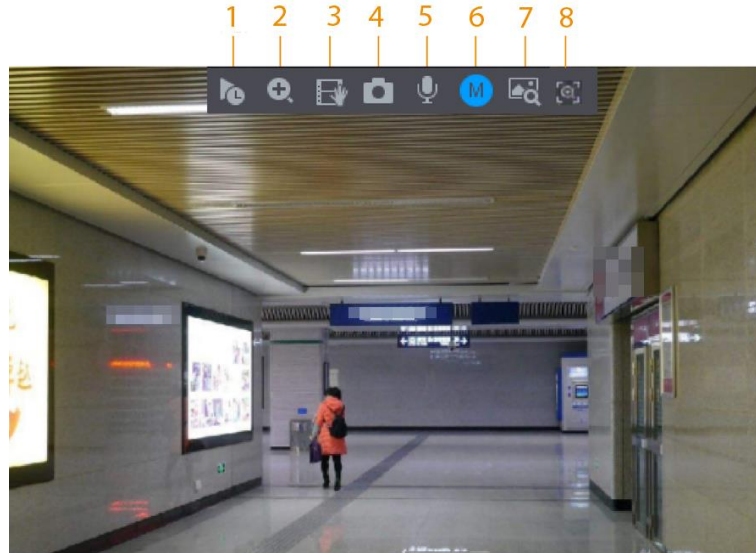

Table 5-9 Live view control bar description

No.	Name	No.	Name
1	Instant playback.	5	Two-way talk.
2	Digital zoom.	6	Stream switch.
3	Instant backup.	7	Picture search.
4	Manual snapshot.	8	Quick pick.

### 5.6.3.1 Instant Playback

You can play back the previous 5-60 minutes record of current channel.

Click  for instant playback.

Figure 5-16 Instant playback

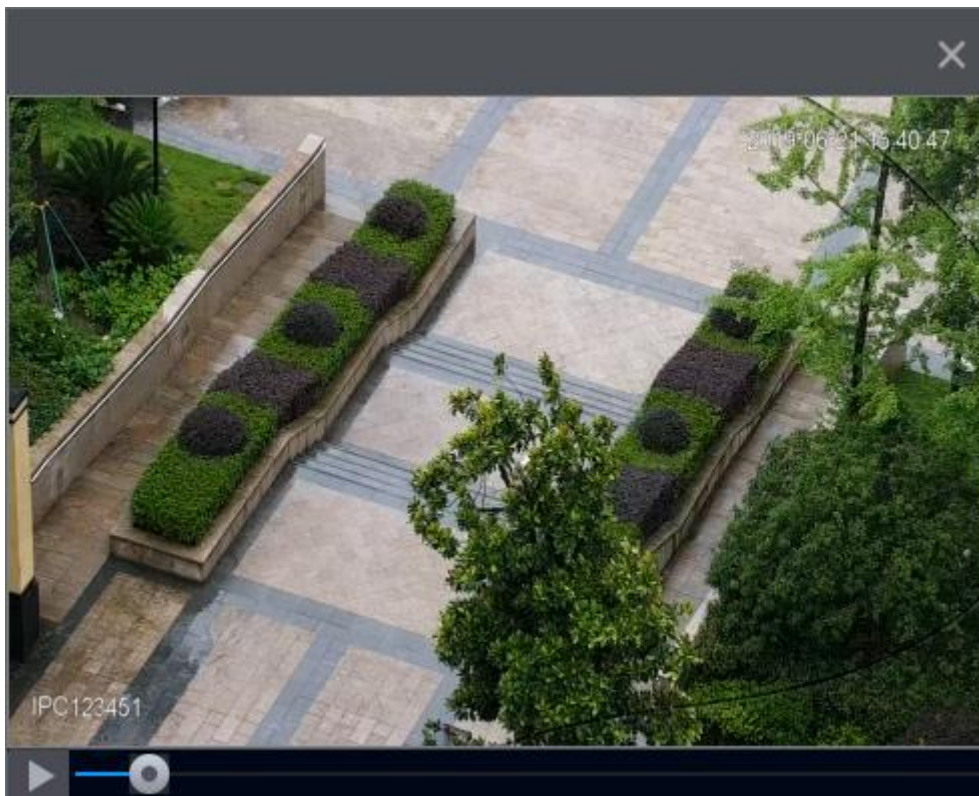

- Move the slider to choose the time you want to start playing.
- You can start, pause and close playback.
- The information such as channel name and recording status icon are shielded during instant playback and will not display until you exit playback.
- During playback, screen split layout switch is not allowed.
- Tour has high higher priority than the instant playback. The instant playback function is not available when tour function is in process and the live view control bar automatically hides either. The function becomes available again after tour ends.



Go to the Main Menu > SYSTEM > General > Basic to set instant playback time.

### 5.6.3.2 Digital Zoom

You can zoom in a specified zone of the current channel to view details. They system supports multi-channel zoom. You can use the digital zoom in the following two ways:

- Click . The icon switches to . Select an area. The area is enlarged after you release the mouse button.



For some models, when the image is enlarged in this way, the selected area is zoomed proportionally according to the window.

- Point to the center that you want to enlarge, and then scroll the mouse to enlarge the area.

When the image is in the enlarged status, you can drag the image toward any direction to view the other enlarged areas. Right-click to cancel zoom and go back to the original video image.

Figure 5-17 Zoom



### 5.6.3.3 Instant Backup

You can record the video of any channel and save the clip to a USB storage device. Clicking  to start the recording. To stop recording, click this icon again. The clip is automatically saved to the connected USB storage device.

### 5.6.3.4 Manual Snapshot

You can take one to five snapshots of the video and save to a USB storage device. Click  to take snapshots. The snapshots are automatically saved to the connected USB storage device. You can view the snapshots on your PC.





To change the quantity of snapshots, select Main Menu > CAMERA > Encode > Snapshot, in the Manual Snapshot list, select the snapshot quantity.

### 5.6.3.5 Two-way Talk

#### Background Information

You can perform the voice interaction between the NVR and the remote device to improve efficiency of emergency.

#### Procedure

- Step 1** Click  to start two-way talk. The icon changes to . The rest two-way talk buttons of digital channel become dimmed.
- Step 2** Click  again to cancel two-way talk.

### 5.6.3.6 Stream Switch

Click  to switch the bit stream type of the main stream and sub stream according to current network bandwidth.

- **M: Main stream:** Its bit streams are big and definition is high. It occupies large network bandwidth suitable for video wall security, storage and more.
- **S: Sub stream:** Its definition is low but occupies small network bandwidth. It is suitable for general security, remote connection and more. Some models support two sub streams (S1, S2).

### 5.6.3.7 Picture Search

#### Background Information

Select the image of target person on the live view page and then search by image for all the related videos with the target person.

#### Procedure

**Step 1** Click . The live image is frozen.

**Step 2** Draw a search range according to the on-screen prompt, and then click OK.



You can adjust the searching area. Make sure that there are less than 30 faces in the selected range.

Figure 5-18 Draw a searching range

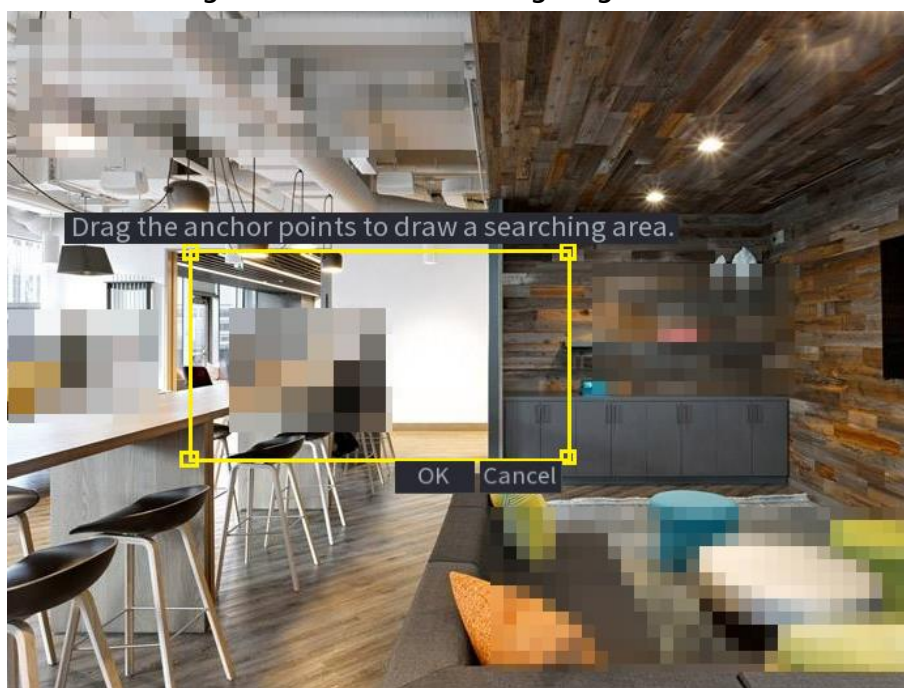

**Step 3** Select the target face that you want to search for. You can select maximum 8 target faces.





**Step 4** Click Search. The search results are displayed.

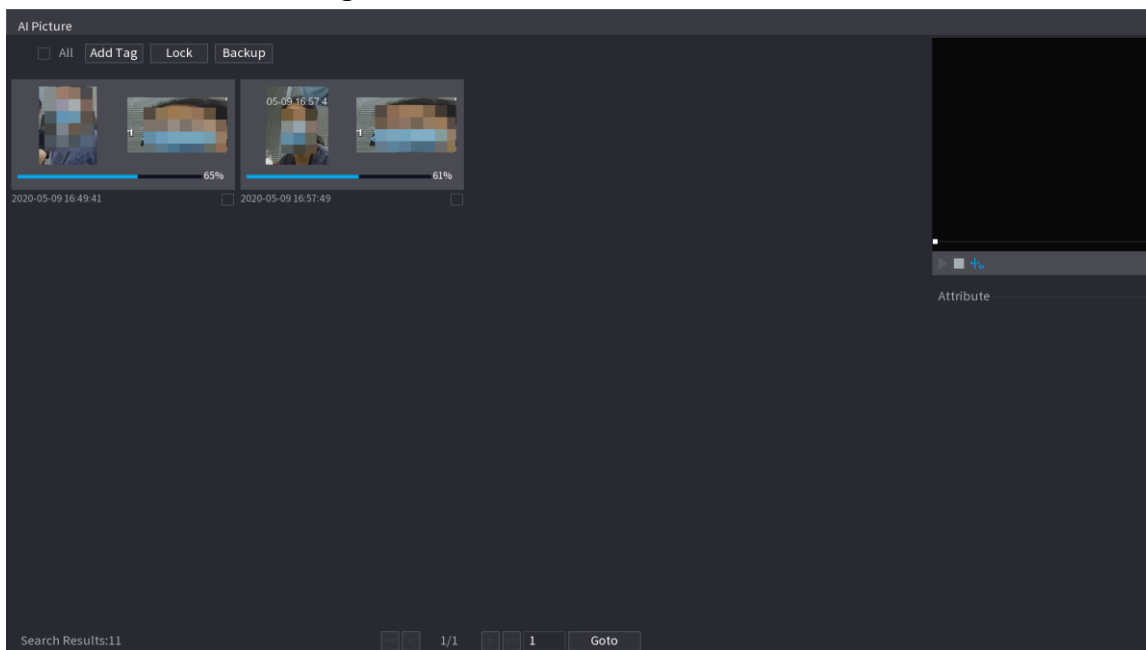

Figure 5-19 Picture search results



## Related Operations

- **Play video.**  
 Select the picture and then click  to play back the video within 10 seconds before and after the snapshot. During playback, you can
  - ◇ Click  to pause.
  - ◇ Click  to stop.
  - ◇ Click  to display or hide the intelligent rules.
- **Add tag.**  
 Select the picture and then click Add Tag to add a tag to the recorded video to find the target recorded video more fast.
- **Lock recorded video.**  
 If you want to keep the recorded video permanently, select the picture, and then click Lock. The locked video cannot be overwritten and deleted.
- **Back up recorded video or picture.**  
 Select the picture, and then click Backup. You can set save path, backup type, and file type, and then export to the external storage device.

### 5.6.3.8 Quick Pick

When connected with select IPC cameras, Quick Pick technology becomes available, allowing human and vehicle targets to be easily searched for and picked out.

#### Procedure

- Step 1** Click  to freeze the live page.
- Step 2** Drag the anchor points to draw a searching area.



You can adjust the searching area. Make sure that there are less than 30 targets in the selected area.

Figure 5-20 Quick pick



**Step 3** Click OK.

The search results are displayed.

Figure 5-21 Search results

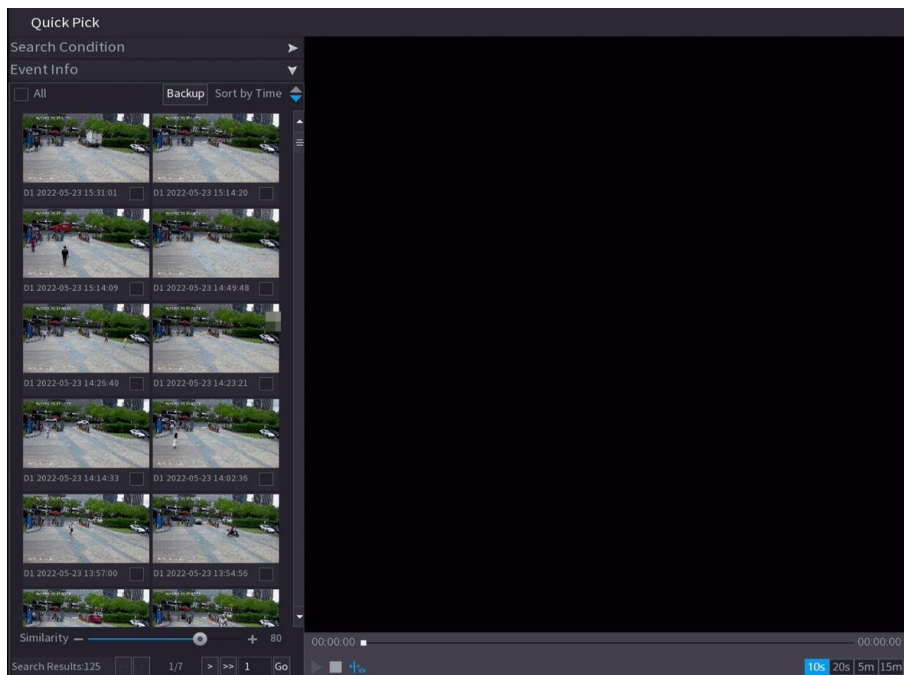

**Step 4** (Optional) Click Search Condition, change the search conditions, and then click Search.





You can only select up to 8 targets for search.

Figure 5-22 Search conditions

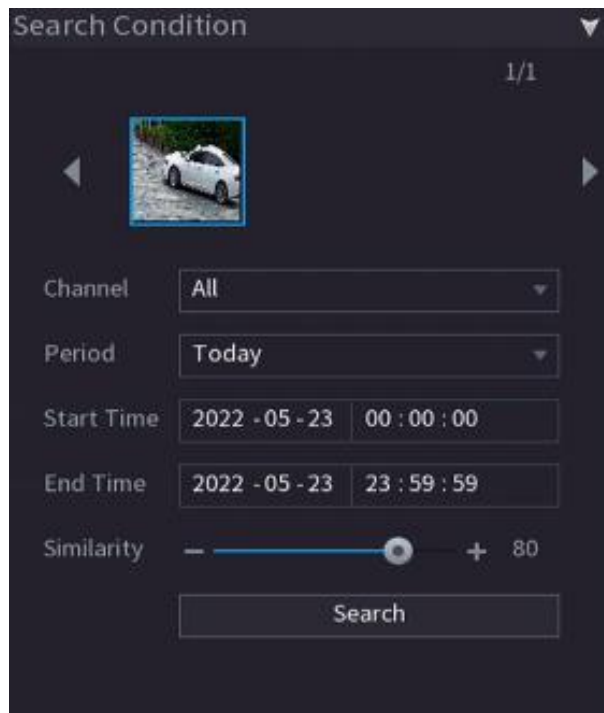

**Step 5** Hover over a search result to view the basic information including channel, start time, end time and target type. Double-click a result to play the video.



You can select one or more search results and then click Backup to back up the results.

## 5.6.4 Shortcut Menu

Right-click the live view page to bring up the shortcut menu. You can go to main menu, play back videos or images, configure view split, and configure the settings of PTZ, image, and more.



The shortcut menu is different for different models.

Figure 5-23 Shortcut menu (1)

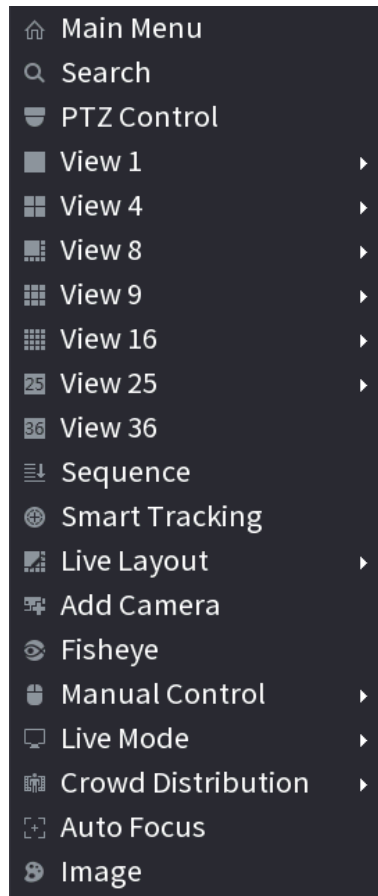

Figure 5-24 Shortcut menu (2)

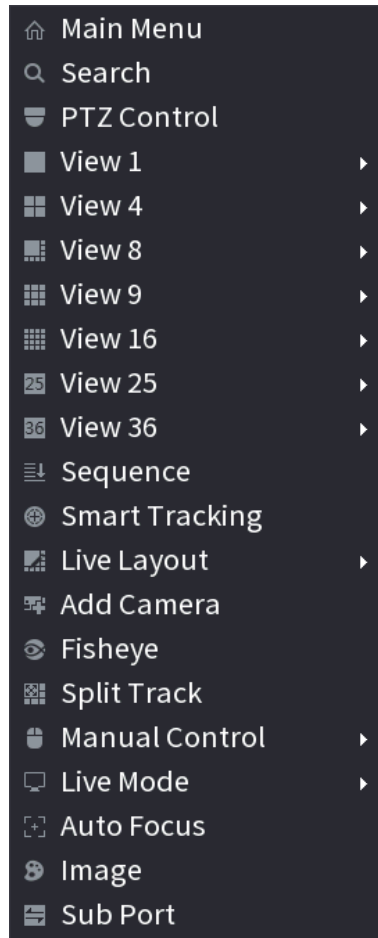

Figure 5-25 Shortcut menu (3)

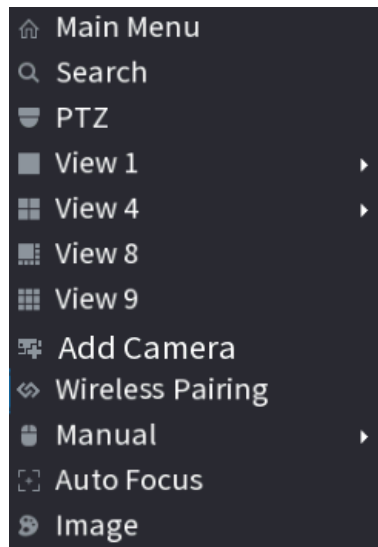



Table 5-10 Shortcut menu description

Function	Description
Main Menu	Go to main menu.
Search	Search and play back videos or images.
PTZ Control	Open the PTZ control panel. For details, see "5.6.7 PTZ".

Function	Description
View 1/4/8/9/16/25/36	Configure the live view screen as a single-channel layout or multi-channel layout.
Sequence	Set customized screen split mode and channels. For details, see "5.6.9 Sequence".
Add Camera	Add cameras to the Device.
Wireless Pairing	Quickly add IPCs. For details, see "5.6.8 Wireless Pairing".
Split Track	Split the screen of a certain channel. For details, see "5.6.6 Split Tracking".
Manual Control	<ul style="list-style-type: none"> <li>Record Mode: You can configure the recording mode as Auto or Manual, or stop the recording. You can also enable or disable snapshot function</li> <li>Alarm Mode: You can configure alarm output settings.</li> </ul>
Live Mode	Select General or Analytics+ Mode. In the Analytics+ mode, the information of detected face, human or vehicles are displayed on the right side of the live page.
Crowd Distribution	Select On or Close to enable or disable crowd distribution function.
Auto Focus	Click to realize auto focus function.  Make sure the connected camera supports this function.
Image	Click to modify the camera image parameters. For details, see "5.7.4 Configuring Image Settings".
Sub Screen	Click Sub Screen to switch to the current monitor to the sub screen.
Smart Tracking	Enable smart tracking to track targets manually or automatically.
Mirror Sub Screen	Displays the image of the sub screen on the main screen.

## 5.6.5 Analytics+ Live View Mode

### Background Information

When you select Analytics+ mode, the system displays information of human face, personnel, vehicle and non-motor vehicle on the right side of the live page, and it supports to play back records and display feature attributes.



You need to enable face detection, body detection, vehicle detection and non-motor vehicle detection to support this function. For details, see "5.9.8.2 Configuring Video Metadata".

### Procedure

Step 1 Right-click the live page, and then select Analytics+ Mode as Live Mode.

Figure 5-26 Analytics+ live view

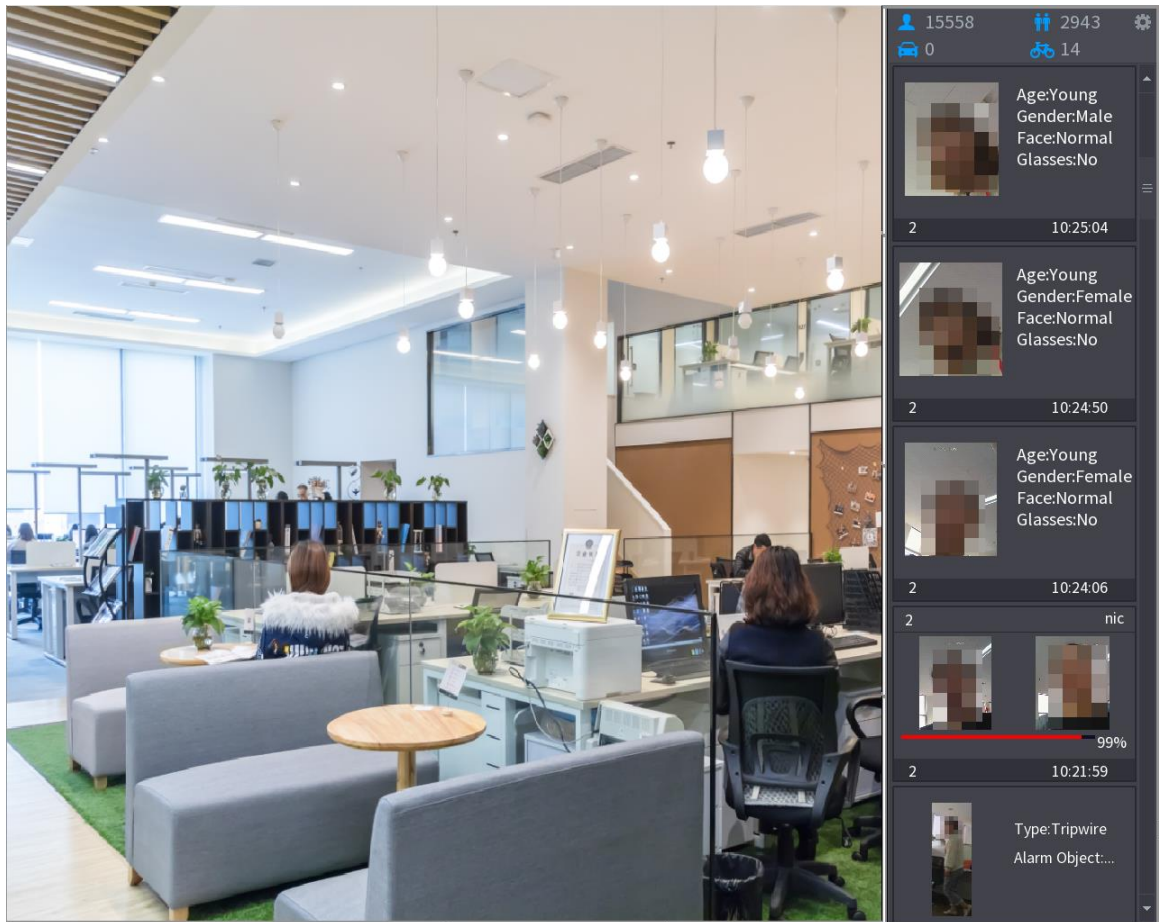

**Step 2** (Optional) Double-click the image on the right to play the corresponding video.

**Step 3** Click , and then select the face attributes that you want to display. You can select up to four attributes.

Figure 5-27 Face vehicle properties

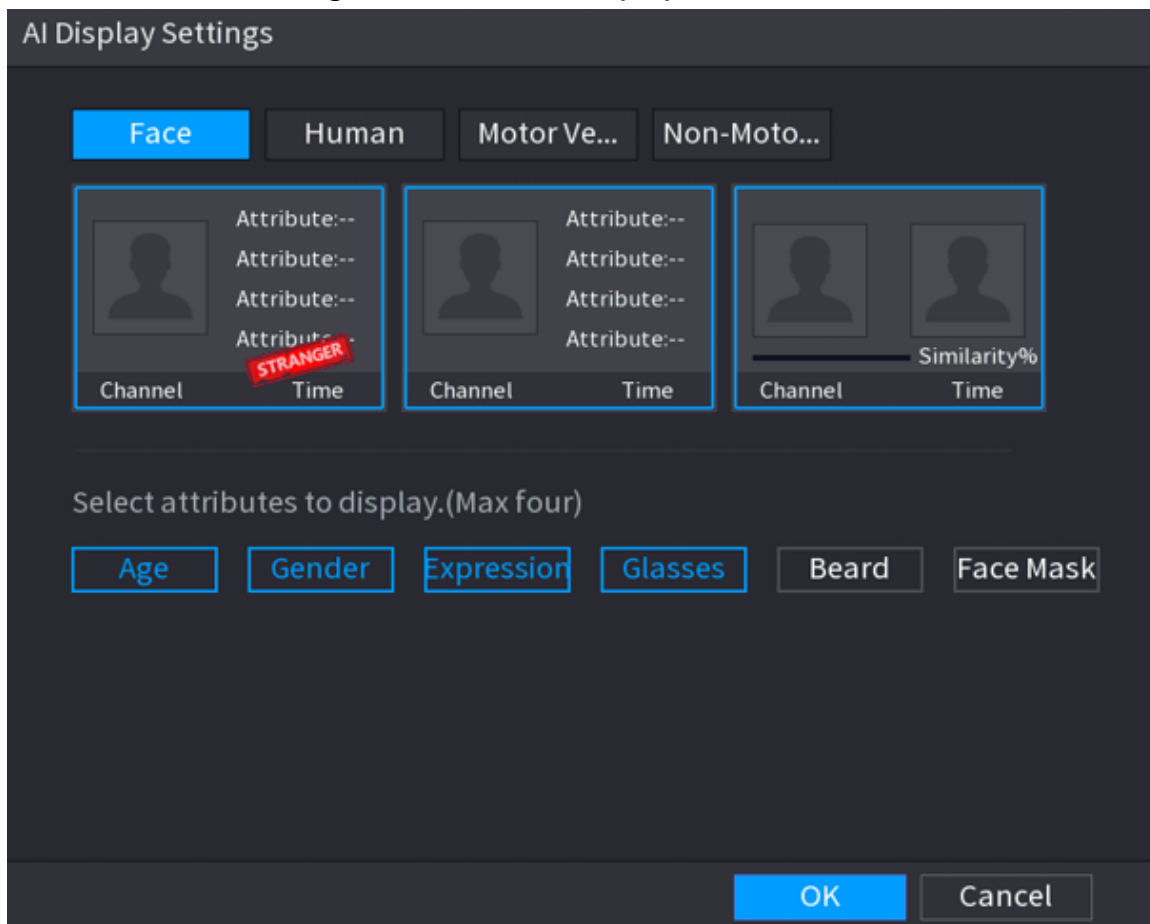

**Step 4** Click OK.



The system can display four attributes at most.

## 5.6.6 Split Tracking

You can track window split for a certain channel.

### Background Information



This function is for select models only.

### Procedure

**Step 1** Right-click the live page, and then select Split Track.

Figure 5-28 Split track

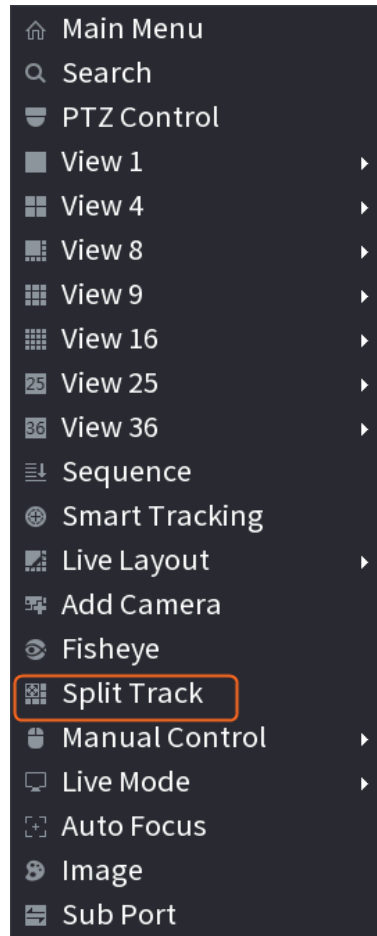

**Step 2** Select a split mode.

Figure 5-29 Split mode

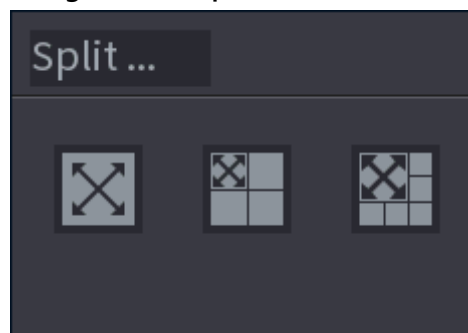

Split mode includes full screen, 1 main screen + 3 split screens and 1 main screen + 5 split screens.

- You can move the rectangles with color to adjust the videos displayed on split screens.
- You can scroll the mouse in split screens to zoom in or out the video.



Figure 5-30 Split display



## 5.6.7 PTZ

PTZ is a mechanical platform that carries a camera and a protective cover and performs overall control remotely. A PTZ can move in both horizontal and vertical direction to provide all-around view to the camera.



Before you control the PTZ, make sure the PTZ decoder and the NVR network connection is OK.

### 5.6.7.1 PTZ Settings

#### Background Information

You can set different PTZ parameters for local type and remote type. Before you use local PTZ, make sure you have set PTZ protocol; otherwise you cannot control the local PTZ.

- Local: The PTZ device connects to the NVR through the cable.
- Remote: The PTZ device connects to the NVR through the network.



This function is available on select models.

#### Procedure

**Step 1** Select Main menu > Camera > PTZ.



Figure 5-31 PTZ (local)

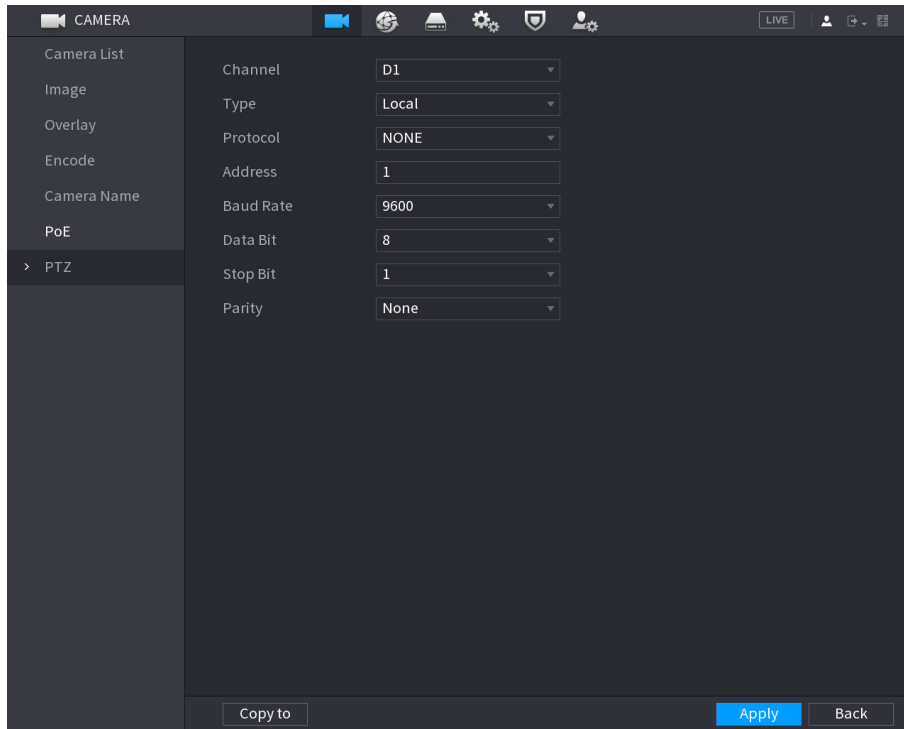
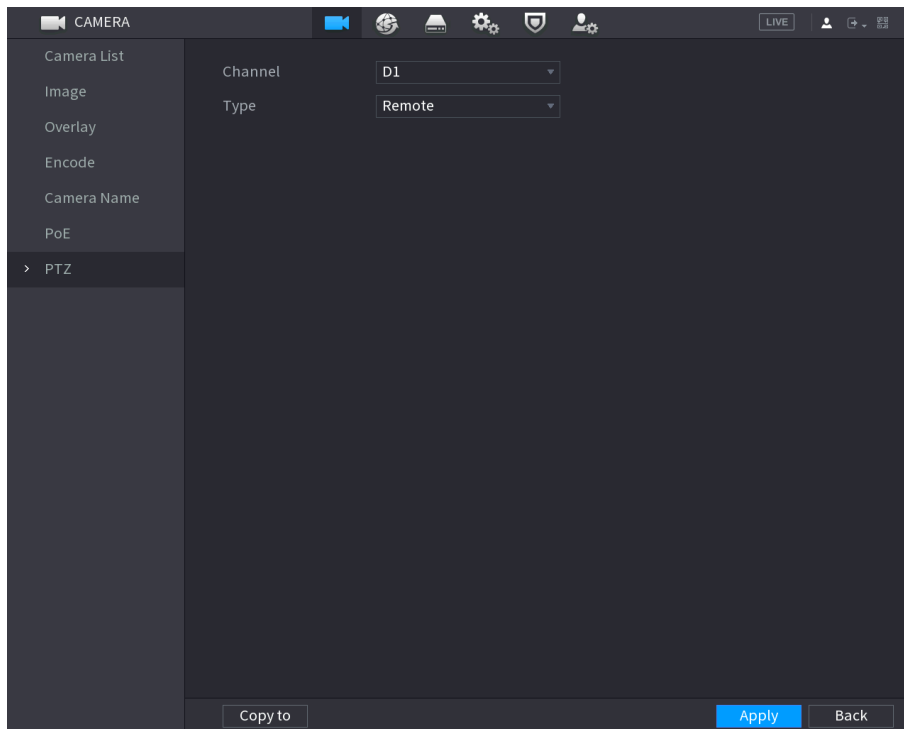



Figure 5-32 PTZ (remote)



**Step 2** Configure parameters.

Table 5-11 PTZ parameters

Parameter	Description
Channel	Select the channel that you want to connect the PTZ camera to.

Parameter	Description
Type	<ul style="list-style-type: none"> <li>Local: Connect through RS-485 port.</li> <li>Remote: Connect through network by adding IP address of PTZ camera to the Device.</li> </ul>
Protocol	Select the protocol for the PTZ camera such as PELCOD.
Address	Enter the address for PTZ camera. The default is 1.  The entered address must be the same with the address configured on the PTZ camera; otherwise the system cannot control PTZ camera.
Baud rate	Select the baud rate for the PTZ camera. The default is 9600.
Data Bit	The default value is 8.
Stop Bit	The default value is 1.
Parity	The default value is None.

**Step 3** Click Apply.

## 5.6.7.2 PTZ Control

You can use the PTZ control panel to perform the operations such as directing camera in eight directions, adjusting zoom, focus and iris settings, and quick positioning.

### Basic PTZ Control Panel

Right-click the live page, and then select PTZ Control.

Figure 5-33 Basic PTZ control panel

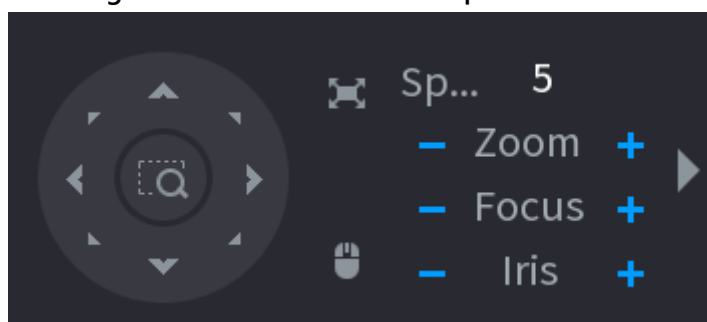

- The gray button means system does not support current function.
- For some model, the PTZ function is available only in one-window mode.

Table 5-12 PTZ control parameters

Parameter	Description
Speed	Controls the movement speed. The bigger the value, the faster the movement.

Parameter	Description
Zoom	: Zoom out. : Zoom in.
Focus	: Focus far. : Focus near.
Iris	: Image darker. : Image brighter.
PTZ movement	Supports eight directions.
	Fast positioning button. <ul style="list-style-type: none"> <li>Positioning: Click the icon, and then click any point on the live page. The PTZ will turn to this point and locate this point in the center.</li> <li>Zooming: Click the icon, and then drag to draw a square on the view. The square supports zooming.                             <ul style="list-style-type: none"> <li>Drag upward to zoom out, and drag downward to zoom in.</li> <li>The smaller the square, the larger the zoom effect.</li> </ul> </li> </ul> <p>This function is available on select models, and can only be controlled through mouse operations.</p>
	Click the icon, and then you can control the four directions (left, right, up, and down) of PTZ movement through mouse operation.
	Open the expanded PTZ control panel.

## Expanded PTZ Control Panel

On the basic PTZ control panel, click to open the expanded PTZ control panel to find more options. See Figure 5-34.

Figure 5-34 Expanded PTZ control bar

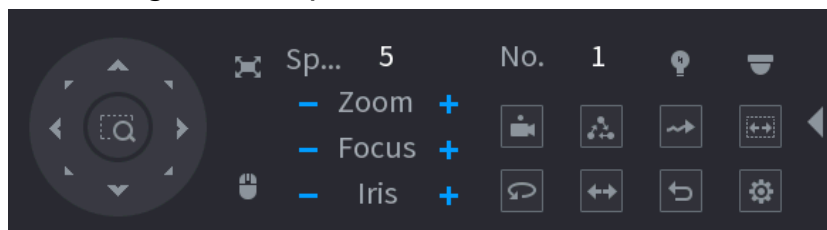



- The functions with buttons in gray are not supported by the system.
- Right-click once to return to the interface of PTZ basic control panel.

Table 5-13 PTZ functions

Icon	Function	Icon	Function
	Preset		Pan
	Tour		Flip
	Pattern		Reset
	Scan		Click the AUX Config icon to open the PTZ functions settings interface.
	AUX Switch		Click the Enter Menu icon to open the PTZ Menu interface.

### 5.6.7.3 Configuring PTZ Functions

#### 5.6.7.3.1 Configuring Presets

##### Procedure

- Step 1** On the expanded PTZ control panel, click

Figure 5-35 Preset

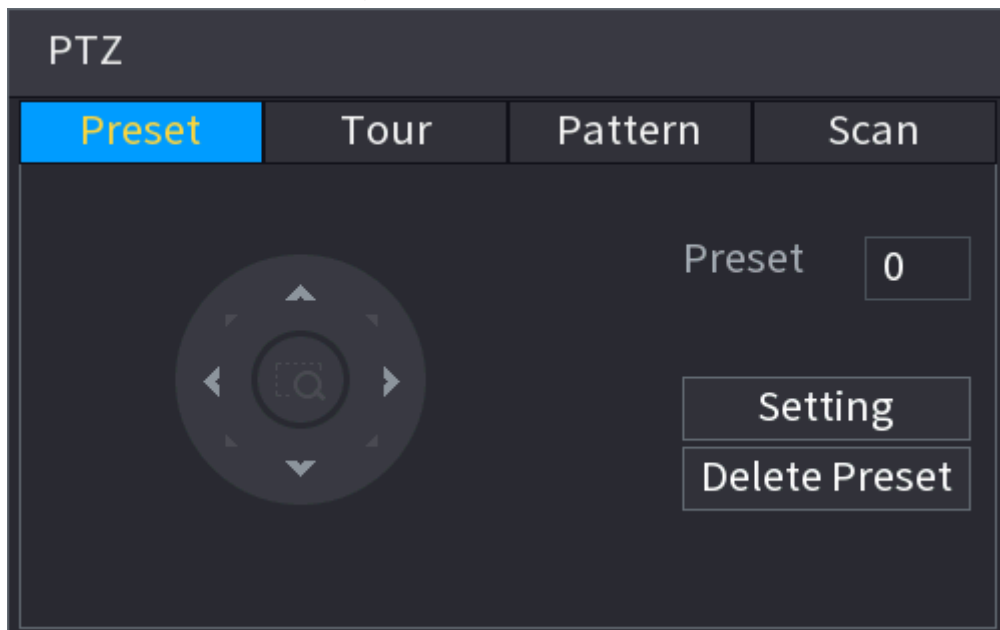

- Step 2** Click the direction arrows to the required position.
- Step 3** In the Preset box, enter the value to represent the required position.
- Step 4** Click Setting to complete the preset settings.

### 5.6.7.3.2 Configuring Tours

#### Procedure

- Step 1** On the expanded PTZ control panel, click .
- Step 2** Click the Tour tab.

Figure 5-36 Tour



- Step 3** In the Tour No. box, enter the value for the tour route.
- Step 4** In the Preset box, enter the preset value.
- Step 5** Click Add Preset.

A preset will be added for this tour.

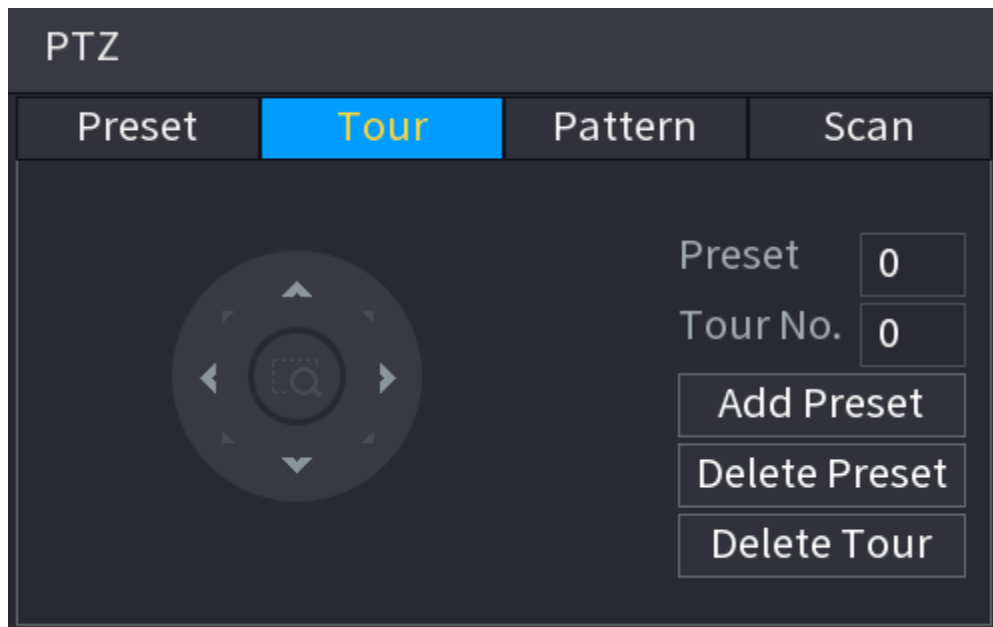

- You can repeat adding more presets.
- Click Delete Preset to delete the preset for this tour. This operation can be repeated to delete more presets. Some protocols do not support deleting.

### 5.6.7.3.3 Configuring Patterns

#### Procedure

- Step 1** On the expanded PTZ control panel, click .
- Step 2** Click the Pattern tab.

Figure 5-37 Pattern



- Step 3 In the Pattern box, enter the value for pattern.
- Step 4 Click Start to perform the directions operations. You can also go to the PTZ Control Panel to perform the operations of adjusting zoom, focus, iris, and directions.
- Step 5 On the PTZ window, click End to complete the settings.

#### 5.6.7.3.4 Configuring AutoScan

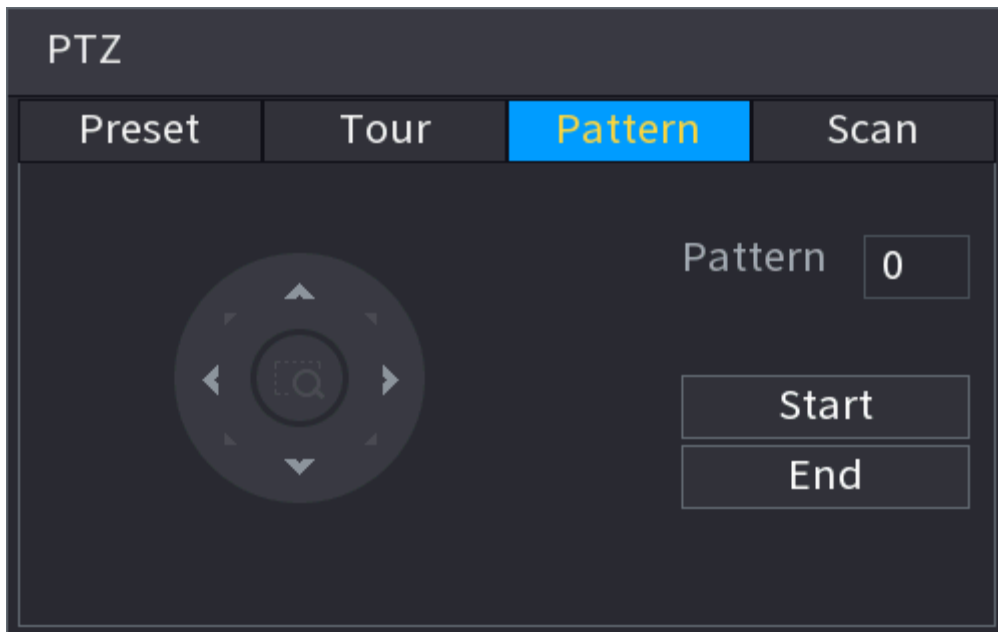
##### Procedure

- Step 1 On the expanded PTZ control panel, click .
- Step 2 Click the Scan tab.

Figure 5-38 Scan



- Step 3 Click the direction arrows to position the left and right limits.

## 5.6.7.4 Using PTZ Functions

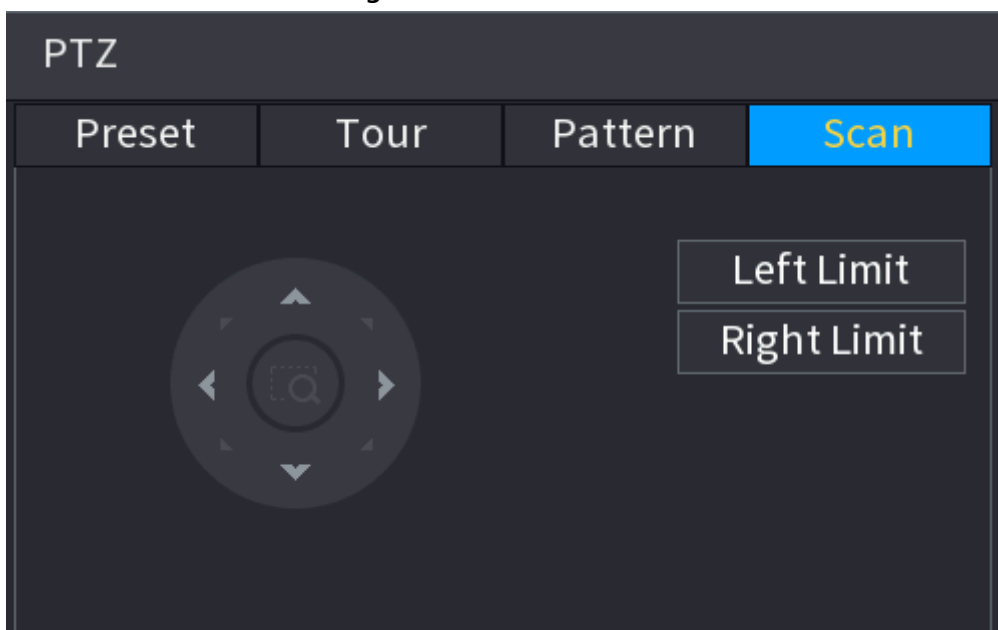

After you have configured the PTZ settings, you can use the PTZ functions from the expanded PTZ control panel.

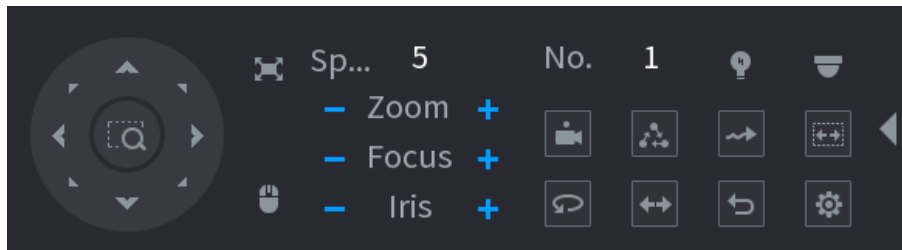
Figure 5-39 Expanded PTZ control panel





### 5.6.7.4.1 Presets

#### Procedure

- Step 1** On the expanded PTZ control panel, in the No. box, enter the value of the preset.
- Step 2** Click  to call the preset.
- Step 3** Click  again to stop calling the preset.



### 5.6.7.4.2 Tours

#### Procedure

- Step 1** On the expanded PTZ control panel, in the No. box, enter the value of the tour.
- Step 2** Click  to call the tour.
- Step 3** Click  again to stop calling the tour.



### 5.6.7.4.3 Patterns

#### Procedure

- Step 1** On the expanded PTZ control panel, in the No. box, enter the value of the pattern.
- Step 2** Click  to call the pattern.  
The PTZ camera moves according to the configured pattern repeatedly.
- Step 3** Click  again to stop calling the pattern.

### 5.6.7.4.4 AutoScan

#### Procedure

- Step 1** On the expanded PTZ control panel, in the No. box, enter the value of the border.
- Step 2** Click .  
The PTZ camera performs scanning according to the configured borders.
- Step 3** Click  again to stop auto scanning.

### 5.6.7.4.5 Calling AutoPan

#### Procedure

**Step 1** On the expanded PTZ control panel, click  to start moving in horizontal direction.

**Step 2** Click  again to stop moving.

### 5.6.7.4.6 Auxiliary Button

On the expanded PTZ control panel, click .

In the Shortcut Aux list, select the option that corresponds to the applied protocol.

In the Aux No. box, enter the number that corresponds to the AUX switch on the decoder.

Figure 5-40 Auxiliary

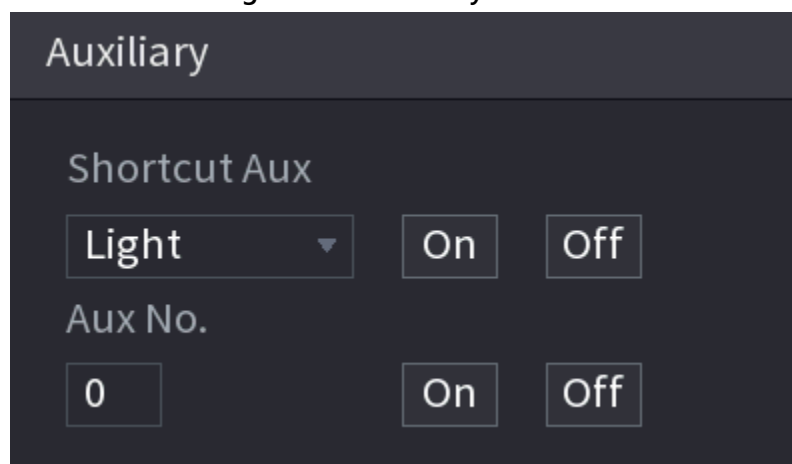

## 5.6.8 Wireless Pairing

You can use the wireless pairing to quickly add IPCs to the NVR.



**Make sure that the IPC and NVR are on the same network segment.**

Right-click the live page, and then select Wireless Pairing. The system starts a 120-second pairing countdown. You can see the video of the paired IPC after pairing is successful.



Figure 5-41 Wireless pairing

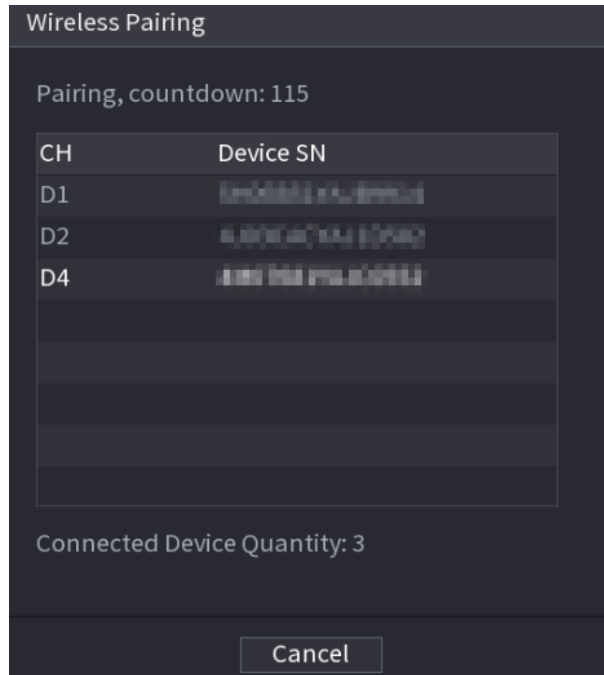

## 5.6.9 Sequence

### Background Information

You can configure the sequence of the channels displayed on the live page.

### Procedure

Step 1 Right-click the live page, and then select Sequence.



- After you select Sequence, the system automatically switches to the max split amount mode.
- The channel list on the Sequence panel displays the added camera channel number and channel name. ● means camera is online. ● means camera is offline.

Figure 5-42 Sequence

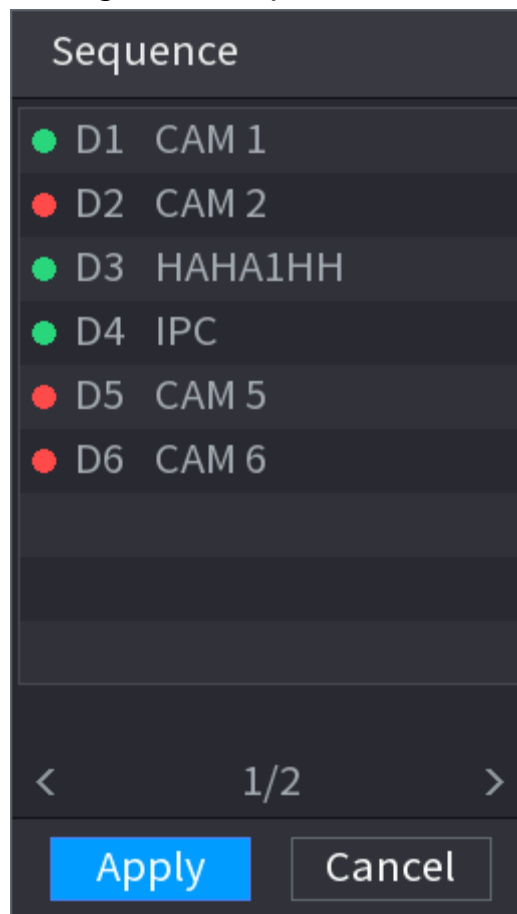

- Step 2** On the Sequence panel, drag the channel to the desired window, or drag on the live window to switch the position.
- Check the channel number at the right bottom corner to view the current channel sequence.

Figure 5-43 Channel number

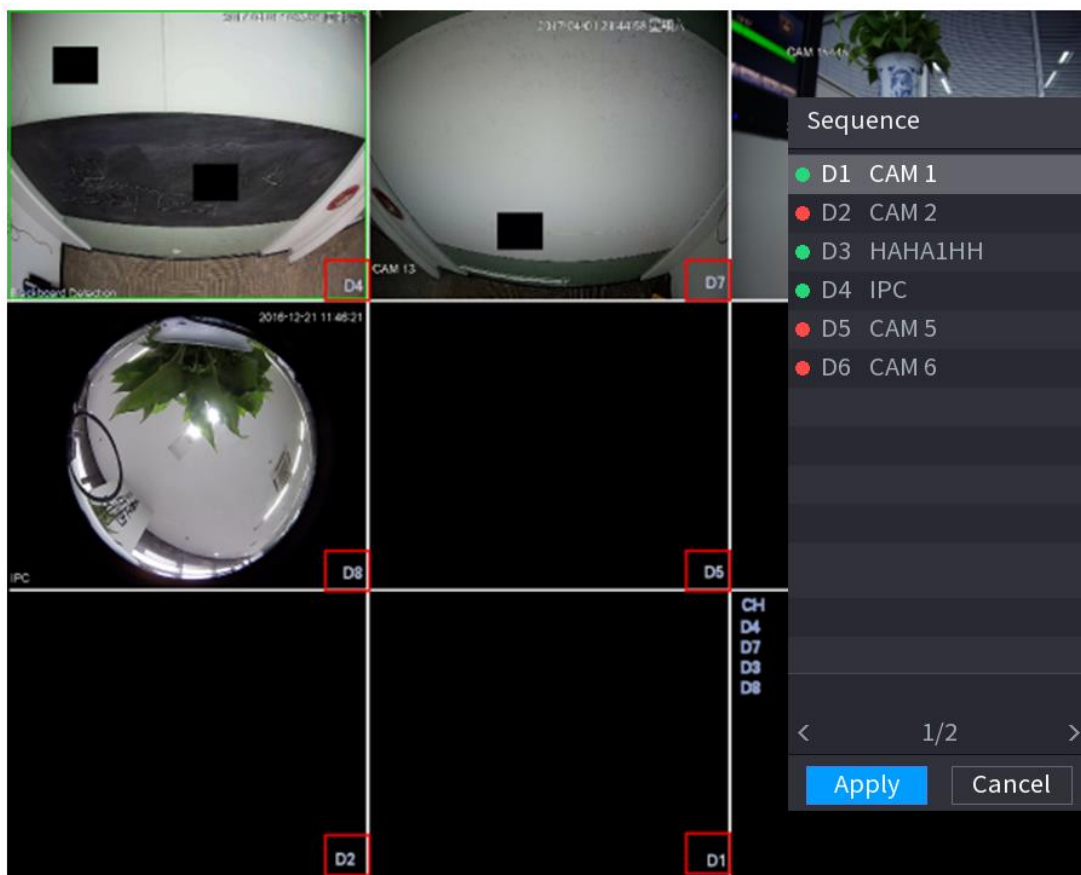

**Step 3** Click Apply.

After you change the channel sequence, click Cancel or right-click the live view page, the system prompts you whether to save the sequence change.

- Click OK to save current settings.
- Click No to exit without saving the settings.

Figure 5-44 Note for saving sequence

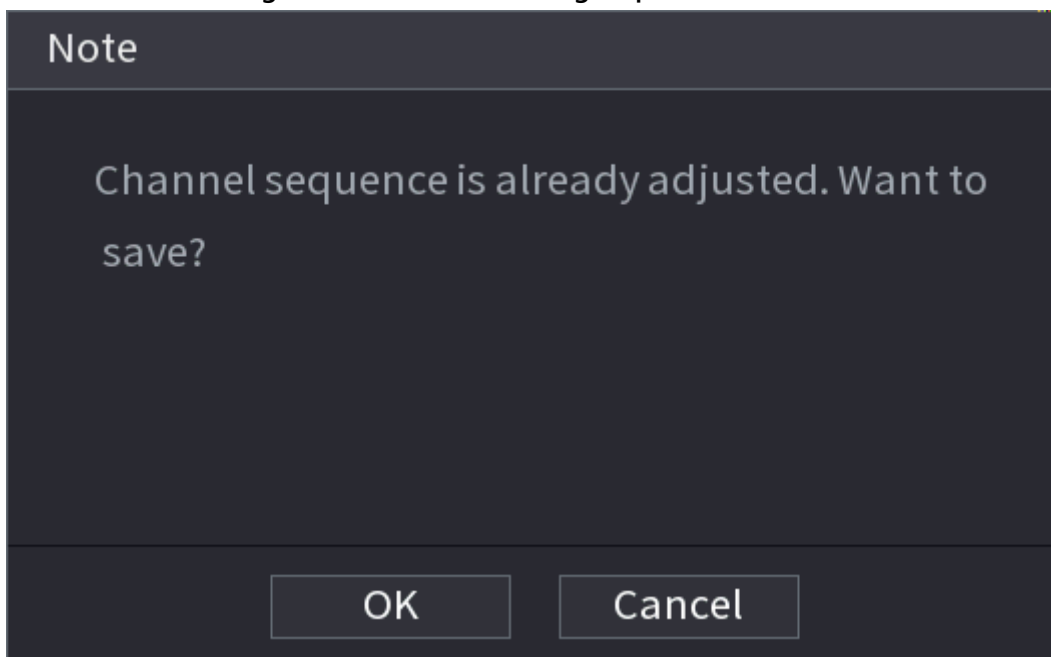

## 5.6.10 Fisheye

This function is for some models only.

### 5.6.10.1 Fisheye De-warp on Live View Interface

The fisheye camera (panoramic camera) has wide video of angle but its video is seriously distorted. The de-warp function can present the proper and vivid video suitable for human eyes.

On the live page, right-click the fisheye channel, and then select Fisheye. You can set fisheye installation mode and display mode.



- For the non-fish eye channel, the system prompts you it is not a fisheye channel and does not support de-warp function.
- If system resources are insufficient, the system prompts you the de-warp function is not available.

Figure 5-45 Fisheye

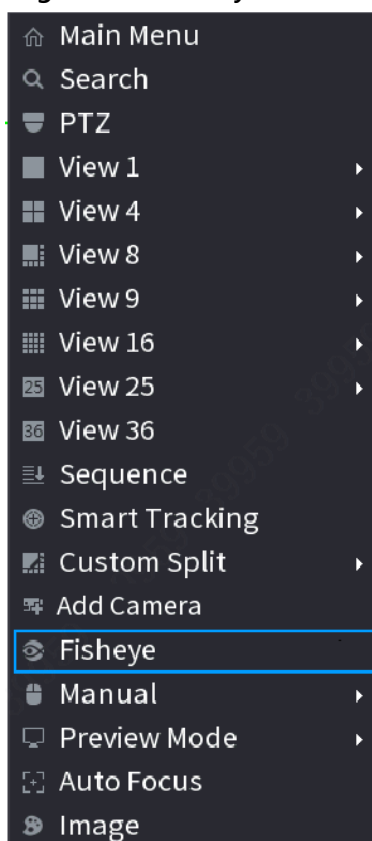

There are three installation modes: ceiling mount, wall mount, and ground mount.



- The different installations modes have different de-warp modes.
- Some models support de-warp of 180° fisheye camera. 180° fisheye camera supports de-warp in wall mount mode only.

Figure 5-46 Fisheye settings

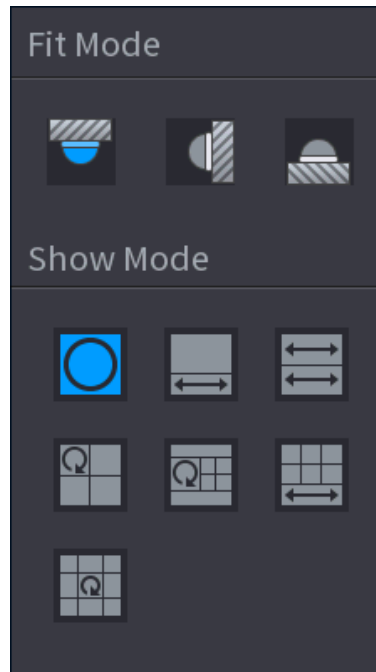

Table 5-14 Installation mode

Installation mode	Icon	Description
(Ceiling mount) (Ground mount)		360° panorama original view
		1 de-warp window+1 panorama stretching
		2 panorama stretching views
		1 360° panorama view+3 de-warp windows
		1 360° panorama view+4 de-warp windows
		4 de-warp windows+1 panorama stretching
		1 360° panorama view+8 de-warp windows
(Wall mount)		360° panorama original view
		Panorama stretching
		1 panorama unfolding view+3 de-warp windows
		1 panorama unfolding view +4 de warp windows

Installation mode	Icon	Description
		1 panorama unfolding view + 8 de warp windows

Figure 5-47 De-warp



You can adjust the color pane on the left pane or use your mouse to change the position of the small images on the right pane to realize fish eye de-warp.



Operation: Use mouse to zoom in, zoom out, move, and rotate the image (Not for wall mount mode.)

### 5.6.10.2 Fisheye De-warp During Playback

#### Background Information

When playing back the fisheye record file, you can use de-warp function to adjust video.

#### Procedure

- Step 1** On the main menu, click BACKUP.
- Step 2** Select 1-window playback mode and corresponding fish eye channel, click  to play.
- Step 3** Right-click , and then you can go to the de-warp playback page. For detailed information, see Figure 5-47.

### 5.6.11 Temperature Monitoring

#### Background Information

When NVR connects to the camera that supports temperature detection, the system can display instant temperature.



- This function might collect the human temperature in the security video.
- This function is available on select models.

## Procedure

- Step 1** Go to Main Menu > DISPLAY > Display to enable the temperature test function.
- Step 2** On the live page, click any position on the thermal channel video. The temperature at the position is displayed.

Figure 5-48 Temperature display

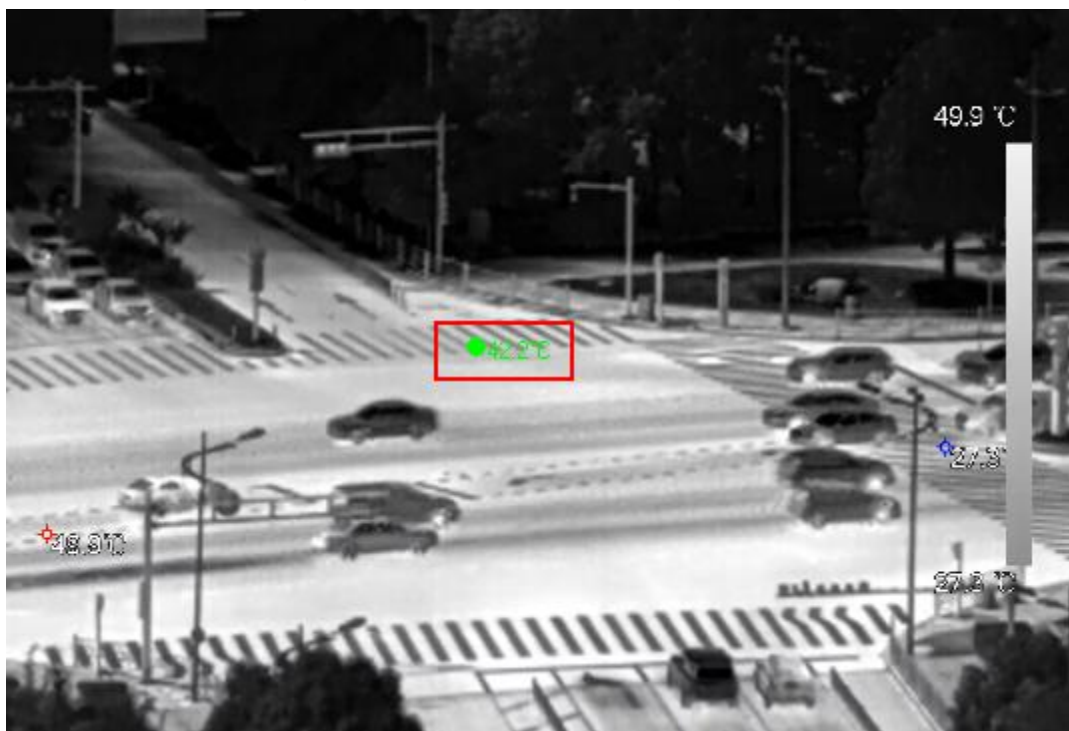

## 5.6.12 Shortcut Menu to Add Camera

### Background Information

You can add cameras on the live page.

### Procedure

- Step 1** On the live page, point to a channel window.  
There is an icon + on the channel window.

Figure 5-49 Add icon

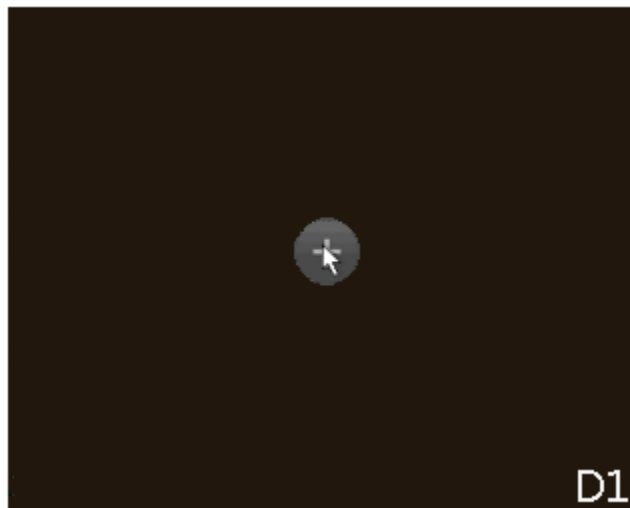

**Step 2** Click "+", and then configure the parameters to add the remote device. For details, see "5.7.2 Adding Remote Devices".

## 5.6.13 Smart Tracking

Track targets manually or automatically. This function is only available on the multi-sensor panoramic camera + PTZ camera.

### Background Information



Make sure that the linked tracking function has been enabled.

### Procedure

**Step 1** Right-click the live video, and then select Smart Tracking.

**Step 2** Select the tracking method.

- Manual positioning: Click a spot or select a zone on the bullet camera video, and then the PTZ camera will automatically rotate there and zoom in.
- Manual tracking: Click or select a target on the bullet camera video, and then the PTZ camera automatically rotates and tracks it.
- Automatic tracking: The tracking action is automatically triggered by tripwire or intrusion alarms according to the pre-defined rules.

## 5.7 Camera

### 5.7.1 Initializing Remote Devices

#### Background Information

You can change the login password and IP address of a remote device when you initialize it.





- When you connect a camera to the NVR via PoE port, NVR automatically initializes the camera. The camera adopts NVR current password and email information by default.
- When you connect a camera to the NVR via PoE port after NVR is upgraded to the new version, the NVR might fail to initialize the camera. You need to initialize the camera manually.

## Procedure

- Step 1** Log in to the local system of the Device.
- Step 2** Right-click the live page and then select Main Menu > CAMERA > Camera List > Camera List.
- Step 3** Click Uninitialized, and then click Search Device.  
The Device displays cameras to be initialized.
- Step 4** Select a camera to be initialized and then click Initialize.

Figure 5-50 Enter password

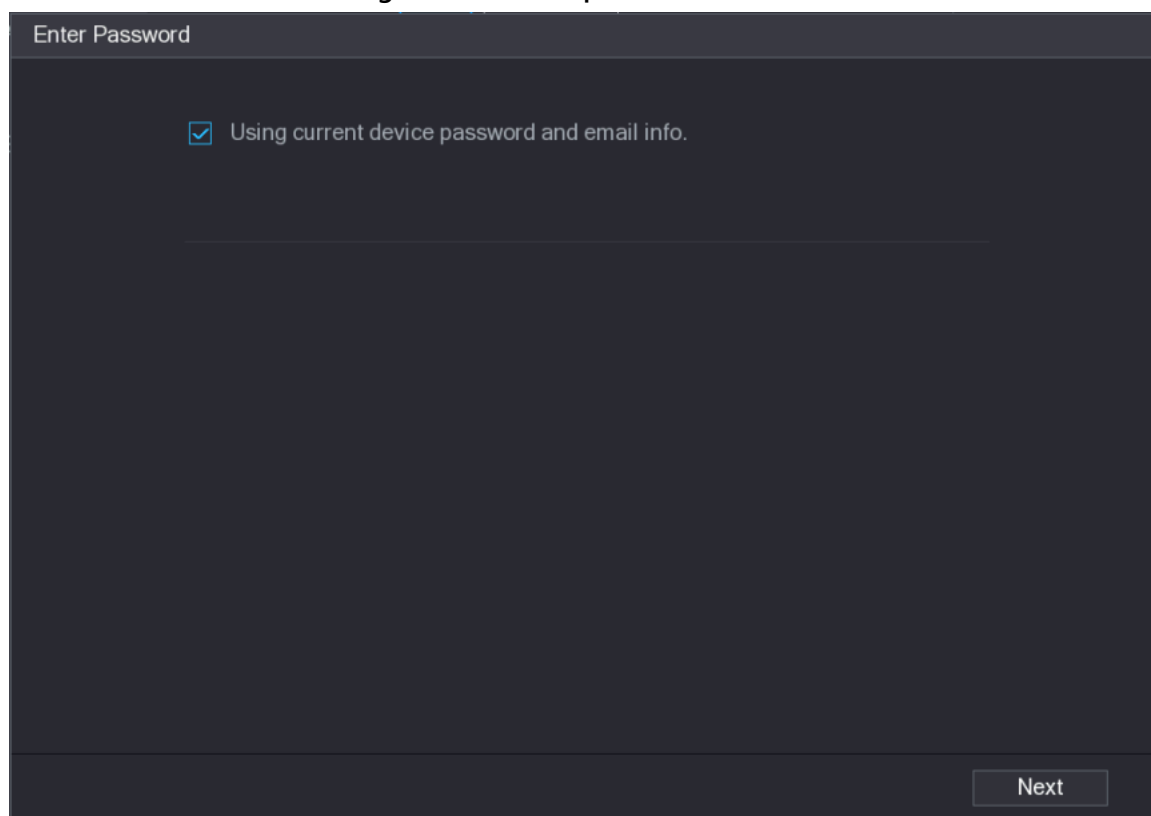

- Step 5** Set password and email information for the remote device.



If you select Using current device password and email info, the remote device automatically uses NVR admin account information (login password and email). You can skip this step.

- 1) Cancel the selection of Using current device password and email info.

Figure 5-51 Password

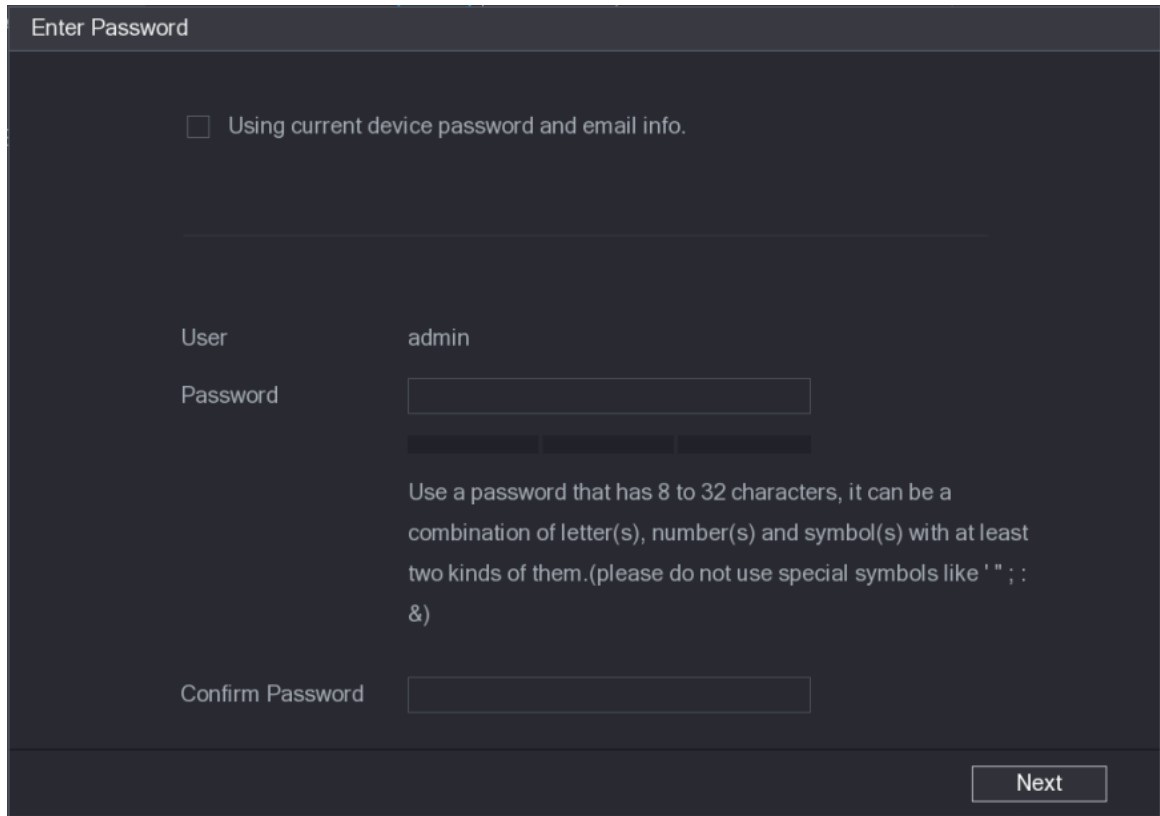

- 2) Enter the password and then confirm it.



For your device security, we recommend you create a strong password according to the password strength indication and change your password regularly.

- 3) Click Next.

Figure 5-52 Password protection

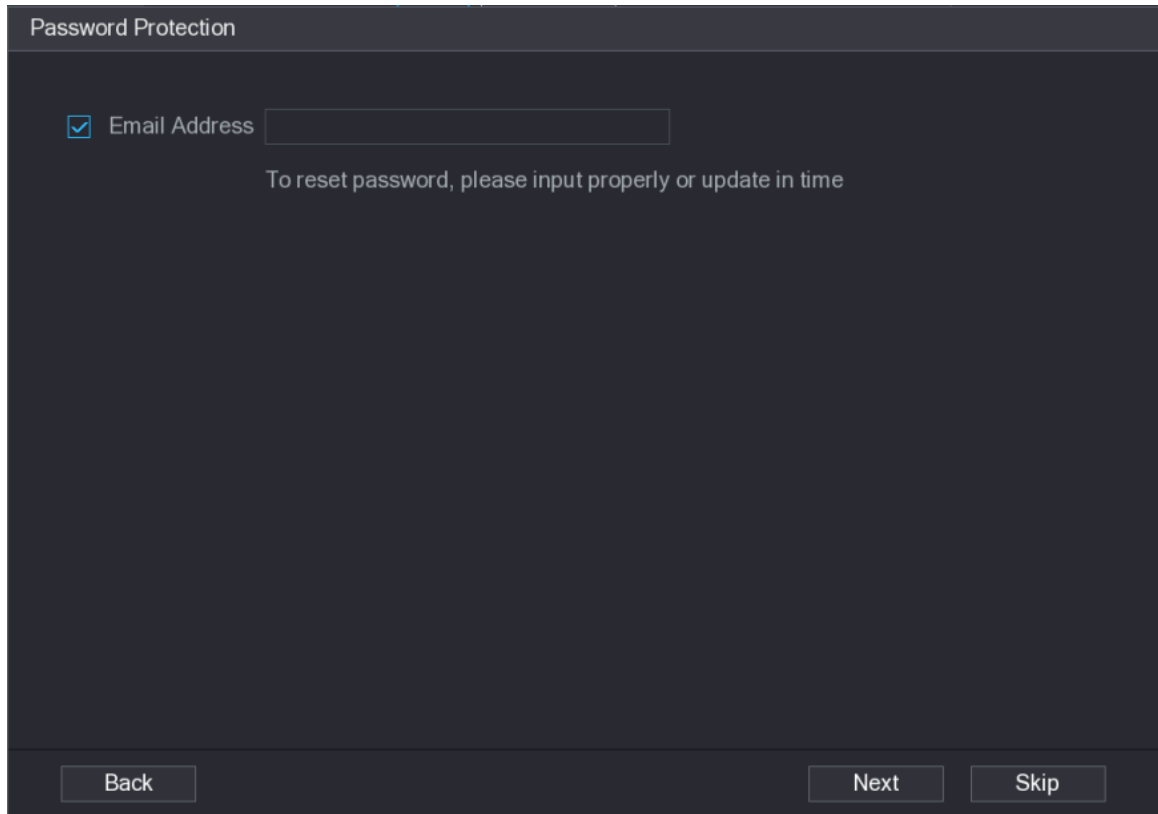

4) Enter your email address, and then click Next.

The email address is used to receive the security code for password resetting.



If you do not want to enter email information, cancel the selection of the checkbox and then click Next or Skip.

**Step 6** Set camera IP address.

- DHCP: There is no need to enter IP address, subnet mask, and default gateway. Device automatically allocates the IP address to the camera.
- Static: You need to enter IP address, subnet mask, and default gateway.



- When you are changing IP addresses of several devices at the same time, enter incremental value. The system can add the fourth decimal digit of the IP address one by one to automatically allocate the IP addresses.
- If an IP conflict occurs when you change static IP address, the system will notify you of the issue. If you change IP addresses in batches, the system automatically skips the conflicted IP and begins the allocation according to the incremental value.

Figure 5-53 Modify IP

Modify IP

Checked Device No.: 1

DHCP
 Username   
 STATIC
 Password

IP Address 
Incremental Value

Subnet Mask

Default Gateway

1	Serial No.	IP Address
1		192.168.1.240

**Step 7** Click Next.

Figure 5-54 Device initialization

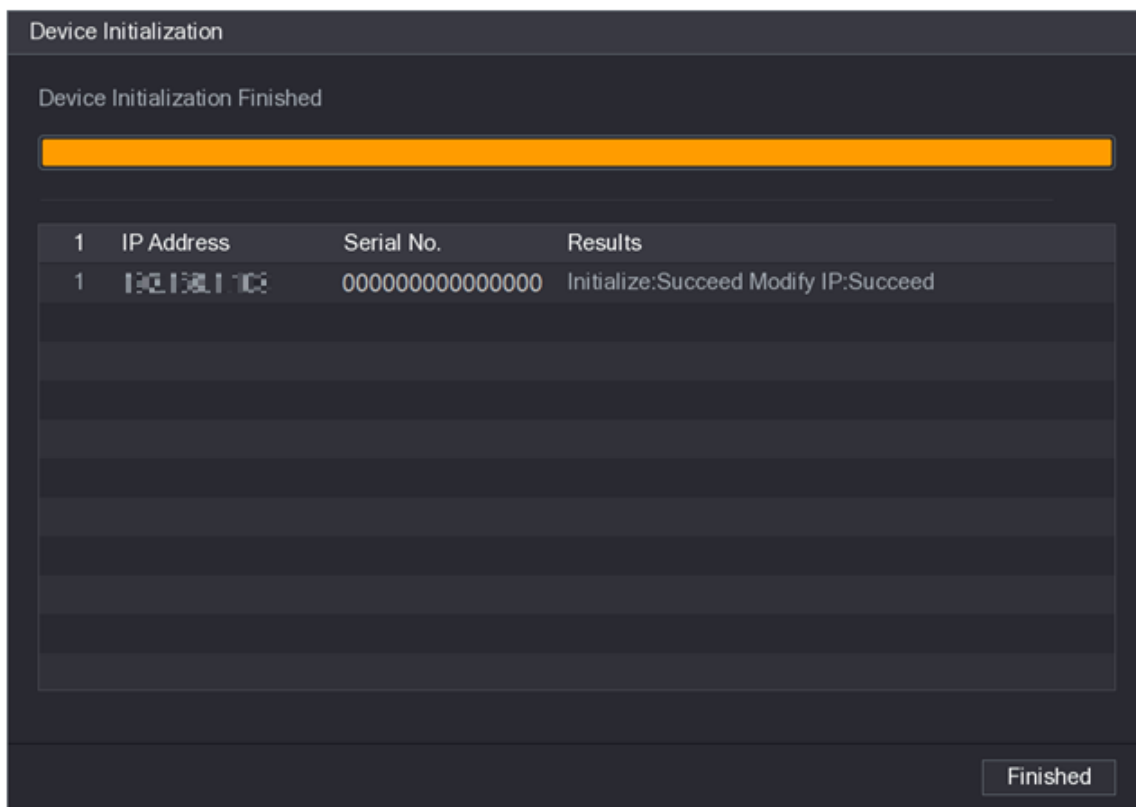

**Step 8** Click Finished.

## 5.7.2 Adding Remote Devices

Add remote devices to the NVR to receive, store, and manage the video streams of the remote device.



Before adding the remote devices, make sure that the devices have been initialized.

### 5.7.2.1 Adding Cameras from Search

#### Background Information

Search for the remote devices that are on the same network with the NVR, and then add the remote devices from the search results.



We recommend this method when you do not know the specific IP address of the remote device.

#### Procedure

**Step 1** Select Main Menu > CAMERA > Camera List > Camera List.

**Step 2** Click Search Device.

The remote devices found are displayed at the upper pane. Devices already added are not included in the searched results.

Figure 5-55 Search device

- For cameras accessed through private protocol, you can click LIVE and then enter the username and password to play live video.
- To filter the remote devices, you can enter all or part of device name in the Filter box.
- To filter out the uninitialized devices, click the Not Initialized tab, and then you can initialize the devices. For details, see "5.7.1 Initializing Remote Devices".
- To view all remote devices added through plug and play, you can click the Not Auto Connected tab. You can remove devices added through plug and play, and they can be automatically added again after plug and play is enabled.

**Step 3** (Optional) Enable Plug and Play.

When Plug and Play is enabled, the NVR automatically adds remote devices on the same subnet.



For uninitialized remote devices, the NVR automatically initializes them before adding them.



**Step 4** (Optional) Enable H.265 Auto Switch.



When H.265 Auto Switch is enabled, the video compression standard of added remote devices is switched to H.265 automatically.

**Step 5** Double-click a remote device, or select a remote device and then click Add to register it to the Added Device list.

## Related Operations

- Change camera login password.  
Select an added camera, and then click Change Camera Login Password to change the password.
- Edit camera information.  
On the Added Device list, click  to change the IP address, username, password and other information.
- Import and export cameras.  
You can export the information of the connected cameras and import camera information to the system to add cameras in batches. For details, see "5.7.2.3 Importing Cameras".
- View linked information.  
If the remote device has multiple channels, you can click the Camera Linked Info to view linked information of the remote device.
- Delete cameras.
  - ◇ Delete one by one.  
Click  to delete the corresponding camera.
  - ◇ Delete in batches.  
Select one or more cameras, and then click Delete.

### 5.7.2.2 Adding Cameras Manually

#### Background Information

Configure the IP address, username, password and other information of the remote device manually to add to the NVR.



We recommend this method when you want to add only a few remote devices and know their IP addresses, usernames and passwords.

### Procedure

**Step 1** Select Main Menu > CAMERA > Camera List > Camera List.

**Step 2** (Optional) Enable H.265 Auto Switch.



When H.265 Auto Switch is enabled, the video compression standard of added remote devices is switched to H.265 automatically.

**Step 3** Click Manual Add.

Figure 5-56 Manual add

**Step 4** Configure the parameters.



The parameters might vary depending on the manufacturer that you select.

Table 5-15 Remote channel parameters

Parameter	Description
Channel	Select the channel that you want use on the Device to connect the remote device.
Manufacturer	Select the manufacturer of the remote device.
IP Address	Enter the IP address of the remote device.



Parameter	Description
RTSP Port	Enter the RTSP port number. The default value is 554.
HTTP Port	Enter the HTTP port number. The default value is 80.
TCP Port	The default value is 37777. You can enter the value as needed.
Username	Enter the username of the remote device.
Password	Enter the password of the user for the remote device.
Total Channels	Click Connect to get the total number of channels of the remote device.
Remote CH No.	Enter the remote channel number of the remote device.
Decode Strategy	Select Default, Realtime, or Fluent.
Protocol Type	<ul style="list-style-type: none"> <li>• If the remote device is added through private protocol, the default type is TCP.</li> <li>• If the remote device is added through ONVIF protocol, the system supports Auto, TCP, UDP, or MULTICAST.</li> <li>• If the remote device is added through other manufacturers, the system supports TCP and UDP.</li> </ul>
Encryption	<p>If the remote device is added through ONVIF protocol, select the Encrypt checkbox and then the system will provide encryption protection to the data being transmitted.</p>  <p>To use this function, make sure that the HTTPS function is enabled for the remote IP camera.</p>

**Step 5** Click OK.

### 5.7.2.3 Importing Cameras

#### Background Information

You can import remote devices in batches.



We recommend this method when you want to add lots of remote devices whose IP addresses, usernames and passwords are not the same.

#### Procedure

**Step 1** Select Main Menu > CAMERA > Camera List > Camera List.

**Step 2** Export the template.



The exported template includes the information of the added remote device. Pay attention to your data security.

1) Click Export.

Figure 5-57 Backup encryption

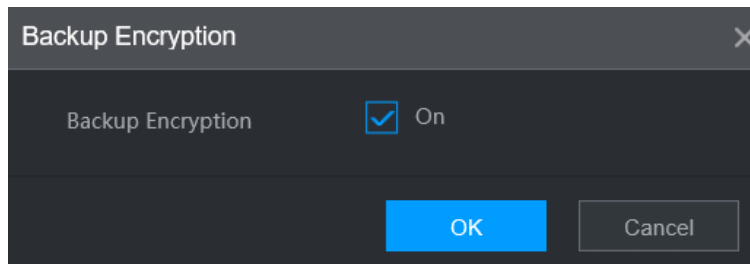

- 2) Cancel the selection of the On checkbox to disable backup encryption, and then click OK.



- If Backup Encryption is enabled, the file format is .backup.
- If Backup Encryption is disabled, the file format is .csv. Keep unencrypted files well to avoid data leakage.

- 3) Select the storage path and then click Save.

- The template file is named RemoteConfig\_20220222191255.csv. 20220222191255 represents the export time.
- The template includes the IP address, port, remote channel No., manufacturer, username, password and other information.

Step 3 Fill in the template and then save the file.



Do not change the file extension of the template. Otherwise, the template cannot be imported.

Step 4 Click Import, select the template file and then open it.

The remote devices in the template are added to the NVR. If the remote device in the template has been added, the system will prompt you whether to replace the existing one on the device list.

- If you select Yes, the system deletes the existing one and import the device again.
- If you select No, the system retains the existing one and add the device to another unoccupied channel.

### 5.7.3 Changing IP Address of Remote Device

The procedures to change the IP addresses of connected and unconnected cameras are different.



You can change the IP address only when the camera is online.

### 5.7.3.1 Changing IP Address of Connected Remote Device

#### Procedure

- Step 1** Select Main Menu > CAMERA > Camera List > Camera List.
- Step 2** On the Added Device list, double-click a remote device or click .
- Step 3** Change the IP address.
- Step 4** Click OK.

### 5.7.3.2 Changing IP Address of Unconnected Cameras

#### Procedure

- Step 1** Select Main Menu > CAMERA > Camera List > Camera List.
- Step 2** Click Search Device.  
The remote devices found are displayed at the upper pane.
- Step 3** Click , or select one or more remote devices and then click Modify IP.



When changing the IP addresses of multiple remote devices at the same time, make sure that they share the same username and password.

- Step 4** Enter username and password of the remote device, and then configure the IP address.
  - DHCP: The remote device gets a dynamic IP address automatically.
  - Static: You need to enter static IP address, subnet mask, and default gateway.  
When changing IP addresses of multiple remote devices at the same time, enter the incremental value so that the system can add the fourth decimal digit of the IP address one by one according to the incremental value.
- Step 5** Click OK.

## 5.7.4 Configuring Image Settings

### Background Information

You can set network camera parameters according to different environments to get the best video effect.

#### Procedure

- Step 1** Select Main Menu > CAMERA > Image.

Figure 5-58 Image

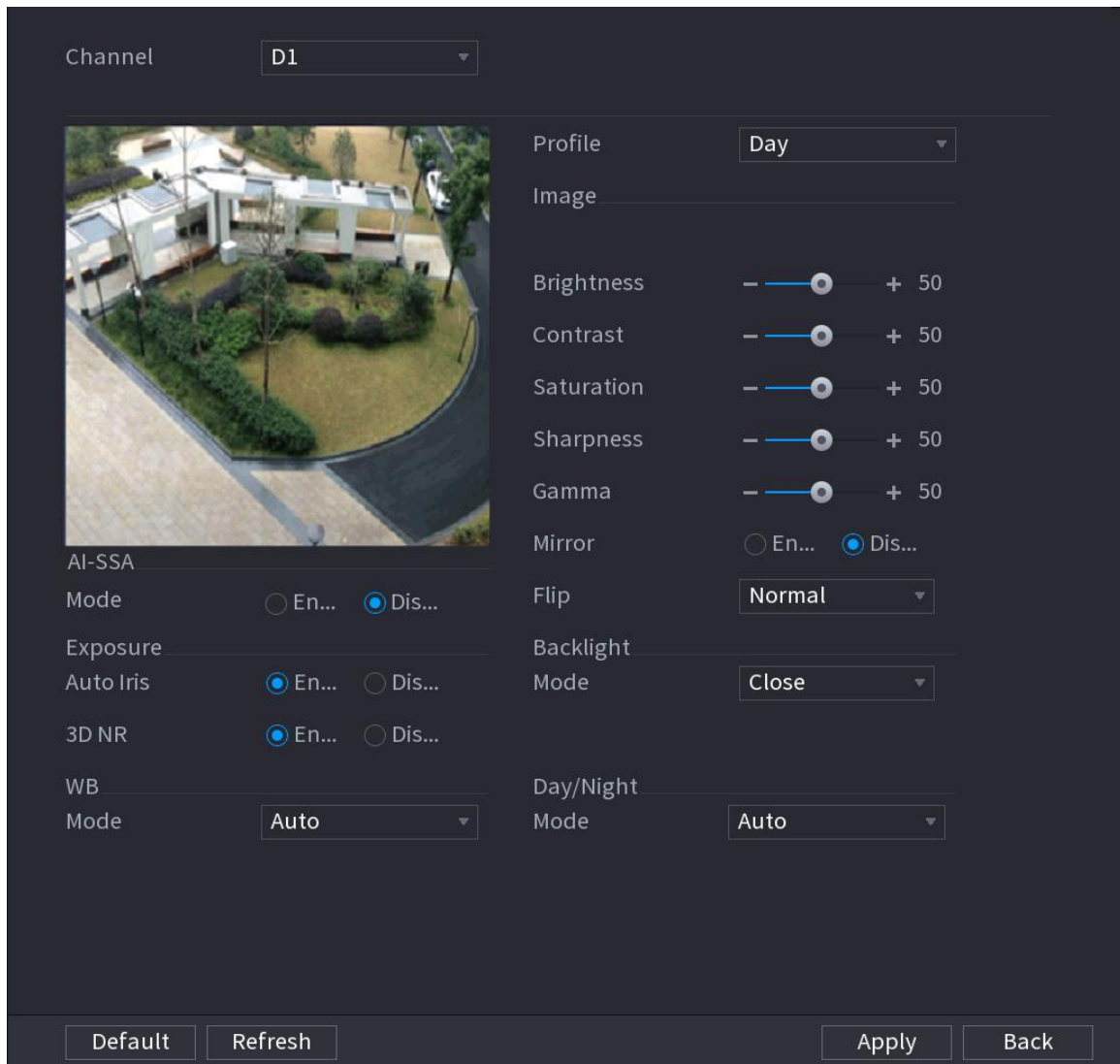



**Step 2** Select a channel and then configure parameters.





The parameters might vary depending on the camera model.

Table 5-16 Image parameters

Parameter	Description
Profile	There are three configuration files. The system has configured the corresponding parameters for each file. You can select according to your actual situation.
Brightness	Adjust the image brightness. The bigger the value is, the brighter the image will become.
Contrast	Adjust the image contrast. The bigger the value is, the more obvious the contrast between the light area and dark area will become.
Saturation	Adjust the color shades. The bigger the value, the lighter the color will become.

Parameter	Description	
Sharpness	Adjust the sharpness of image edge. The bigger the value is, the more obvious the image edge is.	
Gamma	Adjust image brightness and enhance the image dynamic display range. The bigger the value is, the brighter the video is.	
Mirror	Switch the left and right sides of the video image. It is disabled by default.  This function is available on select models.	
Flip	Set video display direction. It includes normal, 180°, 90°, and 270°.	
Analytics+ SSA	After you enable Analytics+ SSA (Analytics+ Scene Self-adaptation), the camera can detect environmental conditions, such as rain, fog, backlight, low light and flicker, to adjust the parameters of the image to suit the conditions, ensuring that clear images are always produced.  When Analytics+ SSA is enabled, some image parameters such as exposure and backlight mode will become unavailable.	
Exposure	Auto Iris	<ul style="list-style-type: none"> <li>This function is available when the camera is equipped with the auto iris lens.</li> <li>After you enable auto iris function, the iris can automatically zoom in and zoom out according to the brightness of the environment and the image brightness changes accordingly.</li> <li>If you disable the auto iris function, the iris is at the biggest value. The iris does not automatically zoom in or zoom out according to the brightness of the environment.</li> </ul>
	3D NR	This function specially applies to the image whose frame rate is configured as 2 at least. It reduces the noise by using the information between two frames. The bigger the value is, the better the effect.

Parameter	Description
Backlight Mode	<p>You can set camera backlight mode.</p> <ul style="list-style-type: none"> <li>• SSA: In the backlight environment, the system can automatically adjust image brightness to clearly display the object.</li> <li>• BLC:                             <ul style="list-style-type: none"> <li>◇ Default: The device performs automatic exposures according to the environment situation to make the darkest area of the video clear.</li> <li>◇ Customize: After you select the specified zone, the system can expose the specific zone so that the zone can reach the proper brightness.</li> </ul> </li> <li>• WDR: In backlight environment, the system lowers the high bright section and enhances the brightness of the low bright section, so that you can view these two sections clearly at the same time.</li> <li>• HLC: In the backlight environment, the system lowers the brightness of the brightest section, reduces the area of the halo and lowers the brightness of the whole video.</li> <li>• Close: Disable the BLC function.</li> </ul>
WB Mode	<p>You can set camera white balance mode. The system adjusts the overall image hue to make the image color display precisely as it is.</p>  <p>Different cameras support different white balance modes, such as auto, manual, natural light, and outdoor.</p>
Day/Night Mode	<p>Configure the color and black &amp; white mode of the image. This parameter is not affected by the configuration files.</p> <ul style="list-style-type: none"> <li>• Color: The camera outputs color image only.</li> <li>• Auto: The camera outputs color images or black and white images according to ambient brightness</li> <li>• B/W: The camera outputs black and white image only.</li> <li>• Sensor: Use this mode when there is peripheral IR light connected.</li> </ul>  <p>The Sensor mode is available on select non-IR models.</p>

**Step 3** Click Apply.

## 5.7.5 Configuring Overlay Settings

You can set parameters for overlay and private masking.

### 5.7.5.1 Overlay

#### Background Information

You can add the information of time and channel in the live view interface.

#### Procedure

**Step 1** Select Main Menu > CAMERA > Overlay > Overlay.

**Step 2** Select a channel and then configure parameters.

Table 5-17 Video overlay parameters

Parameter	Description
Time Title	Display the time tile on the video image in live view and playback. <ol style="list-style-type: none"> <li>1. Select Time Title.</li> <li>2. Drag the time title to a desired place.</li> <li>3. Click Apply.</li> </ol>
Channel Title	Display the channel tile on the video image in live view and playback. <ol style="list-style-type: none"> <li>1. Select Channel Title and then edit the channel title.</li> <li>2. Drag the channel title to a desired place.</li> <li>3. Click Apply.</li> </ol>
Custom Title	You can customize title to be overlaid on the video image. Click Setting to set the information such as font size, title content and text alignment, and then click OK.
Default	Restore the overlay settings to default configuration.
Copy to	Copy the overlay settings to other channels.

**Step 3** Click Apply.

### 5.7.5.2 Privacy Masking

You can mask certain areas of the video image for privacy protection.

#### Procedure

**Step 1** Select Main Menu > CAMERA > Overlay > Privacy Masking.

Figure 5-59 Privacy masking

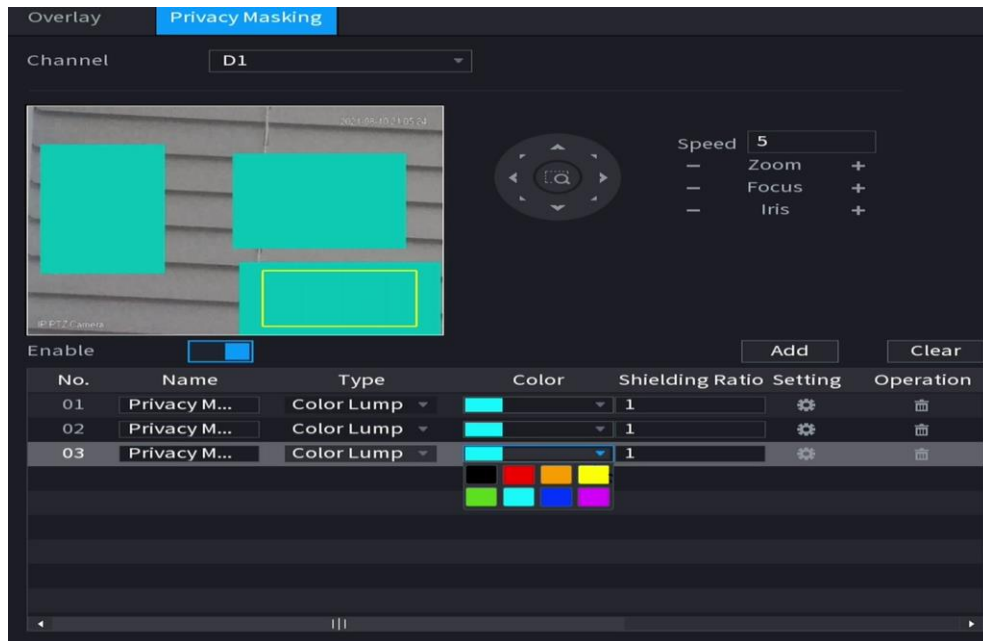

**Step 2** Select a channel.

**Step 3** Click  to enable privacy masking.

**Step 4** Click Add, select the masking type and color, and then draw mosaic or color blocks in the image as needed.

A masking block appears on the video image.



- The number of masking blocks that you can add might differ depending on the camera. You can add up to 24 masking blocks.
- Click Clear to delete all masking areas. Click  to delete a masking area.

**Step 5** Drag the masking block to a desired position and then configure the type, color and other parameters.

**Step 6** Click Apply.

## 5.7.6 Configuring Encoding Settings

You can set video bit stream and image parameters.

### 5.7.6.1 Configuring Audio and Video Encoding Settings

#### Background Information

You can set audio and video encoding parameters such as bit stream type, compression, and resolution.

#### Procedure

**Step 1** Select Main Menu > CAMERA > Encode > Audio/Video.



Figure 5-60 Audio/video

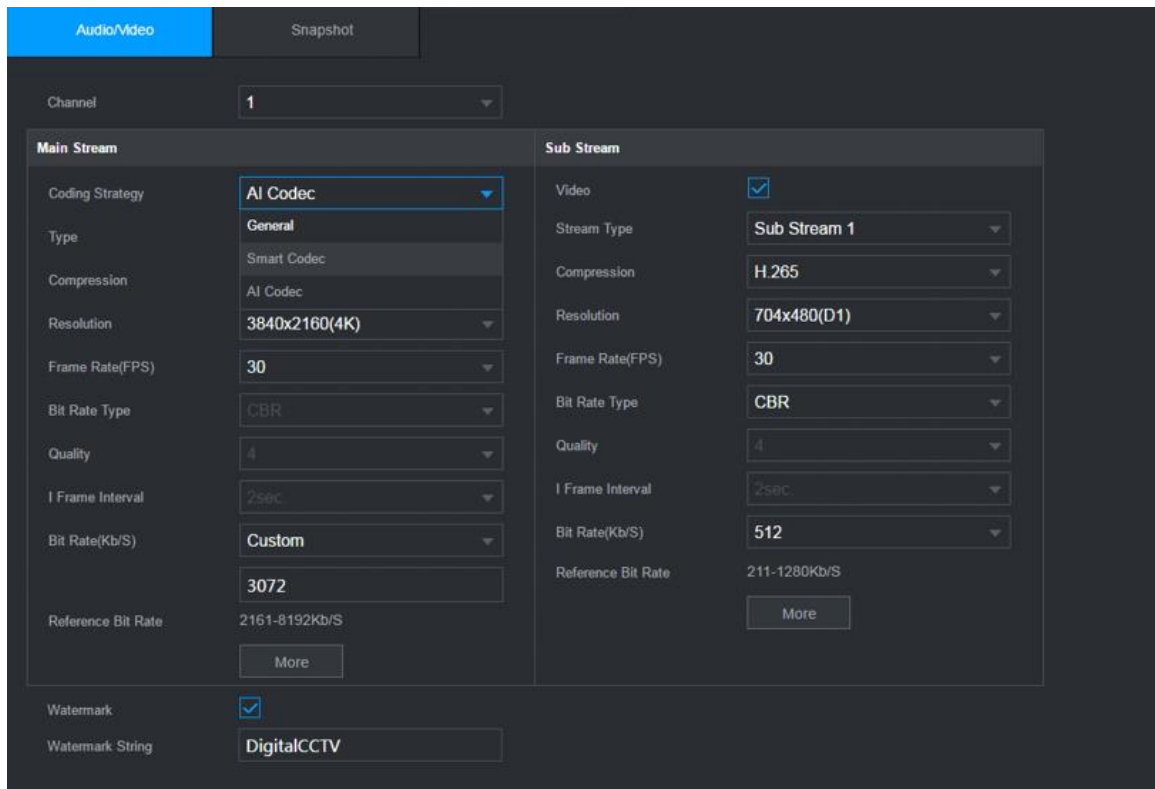



**Step 2** Select a channel and then configure parameters.



The parameters for main stream and sub stream are different. Some models support three streams: main stream, sub stream 1, sub stream 2.

Table 5-18 Audio/video parameters

Parameter	Description
Coding Strategy	<ul style="list-style-type: none"> <li>• General: Use general coding strategy.</li> <li>• Smart Codec: Enable the smart codec function. This function can reduce the video bit stream for non-important recorded video to maximize the storage space.</li> <li>• Analytics+ Codec: Enable the Analytics+ codec function. This function can reduce the camera code stream, network transmission pressure, and hard drive storage space without affecting the image quality.</li> </ul>
Type	Select the recording type for main stream from General, Motion (motion detection), or Alarm.

Parameter	Description
Compression	Select the encoding mode. <ul style="list-style-type: none"> <li>• H.265: Main profile encoding. This setting is recommended.</li> <li>• H.264H: High profile encoding. Low bit stream with high definition.</li> <li>• H.264: Main profile encoding.</li> <li>• H.264B: Baseline profile encoding. This mode requires higher bit stream compared with other modes for the same definition.</li> </ul>
Resolution	Select resolution for the video.  The maximum video resolution might be different depending on your device model.
Frame Rate (FPS)	Configure the frames per second for the video. The higher the value is, the clearer and smoother the image will become. Frame rate changes along with the resolution. Generally, in PAL format, you can select the value from 1 through 25; in NTSC format, you can select the value from 1 through 30. However, the actual range of frame rate that you can select depends on the capability of the Device.
Bit Rate Type	<ul style="list-style-type: none"> <li>• CBR (constant bit rate): The bit rate changes slightly around the defined value. We recommended selecting CBR when there might be only small changes in the monitoring environment.</li> <li>• VBR (variable bit rate): The bit rate changes with monitoring scenes. Select variable stream when there might be big changes in the monitoring environment.</li> </ul>
Quality	The bigger the value is, the better the image will become.  This parameter is available if you select VBR as Bit Rate Type.
I Frame Interval	The interval between two reference frames.
Bit Rate (Kb/S)	<ul style="list-style-type: none"> <li>• Main stream: The higher the value, the better the image quality.</li> <li>• Sub stream: For constant stream, the bit rate changes near the defined value; for variable stream, the bit rate changes along with the image but the maximum value still stays near the defined value.</li> </ul>

Step 3 [Click More.](#)

Figure 5-61 More settings

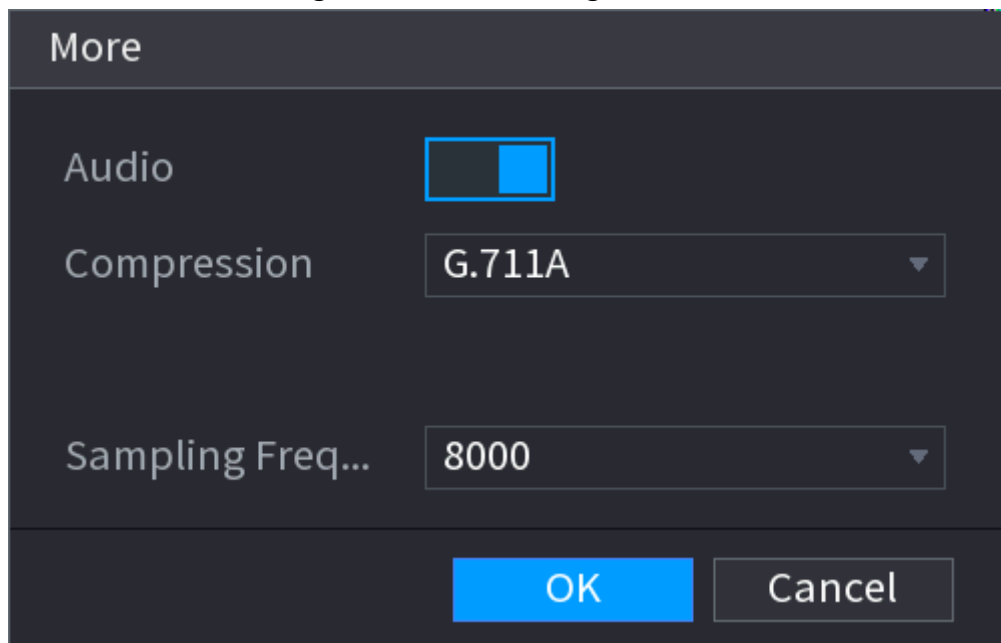

**Step 4** Configure audio compression parameters.

Table 5-19 Audio compression parameters

Parameter	Description
Audio	This function is enabled by default for main stream. You need to manually enable it for sub stream. Once this function is enabled, the recorded video file is composite audio and video stream.
Compression	Select an audio compression format.
Sampling Frequency	Set how many times per second a sound is sampled. The bigger the value, the more natural the sound.

**Step 5** Click OK.

**Step 6** Click Apply.

## 5.7.6.2 Snapshot

### Background Information

You can set snapshot mode, image size, quality and interval.

### Procedure

**Step 1** Select Main Menu > CAMERA > Encode > Snapshot.

Figure 5-62 Snapshot

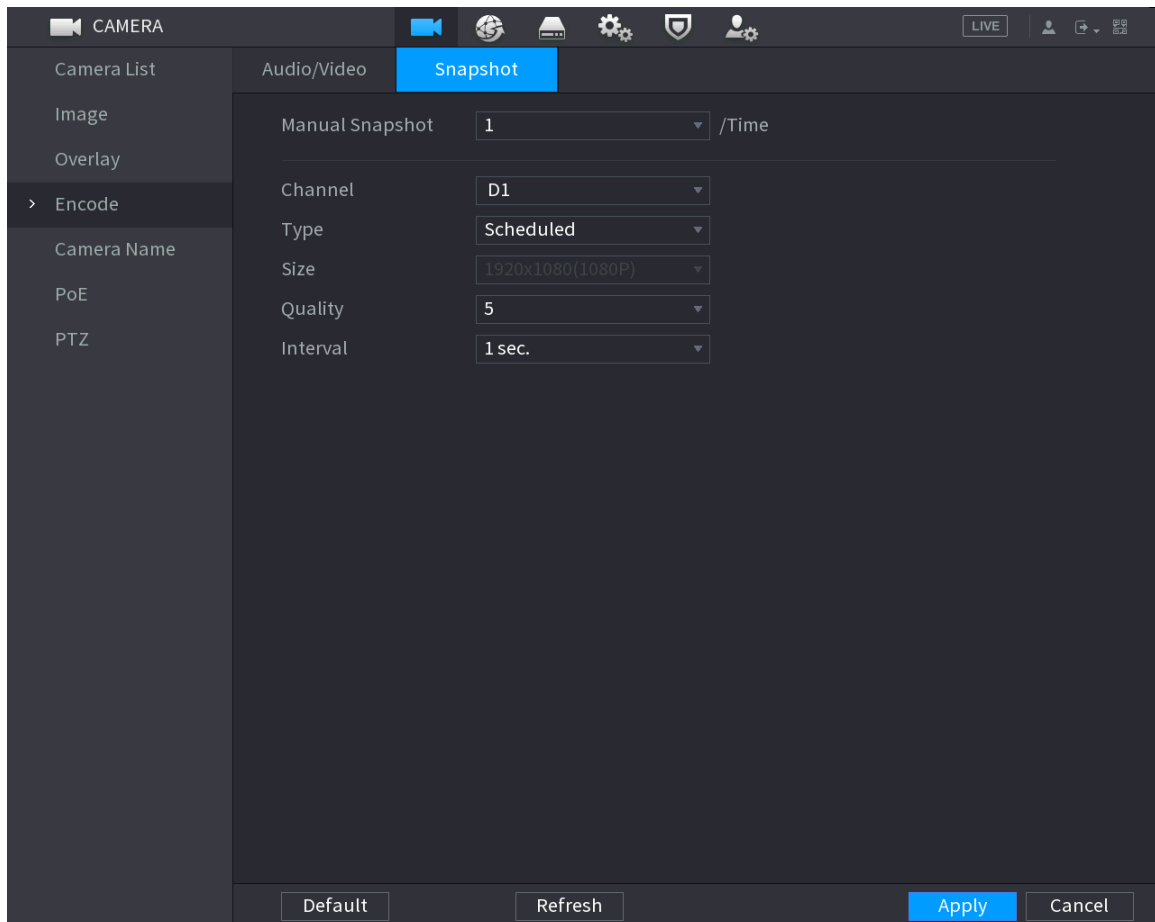

**Step 2** Configure parameters.

Table 5-20 Snapshot parameters

Parameter	Description
Manual Snapshot	Select the number of snapshots that you want to take each time.
Channel	Select the channel that you want to configure the settings for.
Type	<ul style="list-style-type: none"> <li>Scheduled: The snapshot is taken during the scheduled period.</li> <li>Event: The snapshot is taken for motion detection, video loss, local alarms and other events.</li> </ul>
Size	The size is determined by the resolution of the main stream or sub stream of the channel.
Quality	Configure the image quality. The higher the level is, the better the image will become. Level 6 represents the best quality.
Interval	Select or customize how frequently snapshots are to be taken.

**Step 3** Click Apply.

## 5.7.7 Modifying Channel Name

### Background Information

You can customize channel name.

### Procedure

**Step 1** Select Main Menu > CAMERA > Camera Name.

Figure 5-63 Camera name

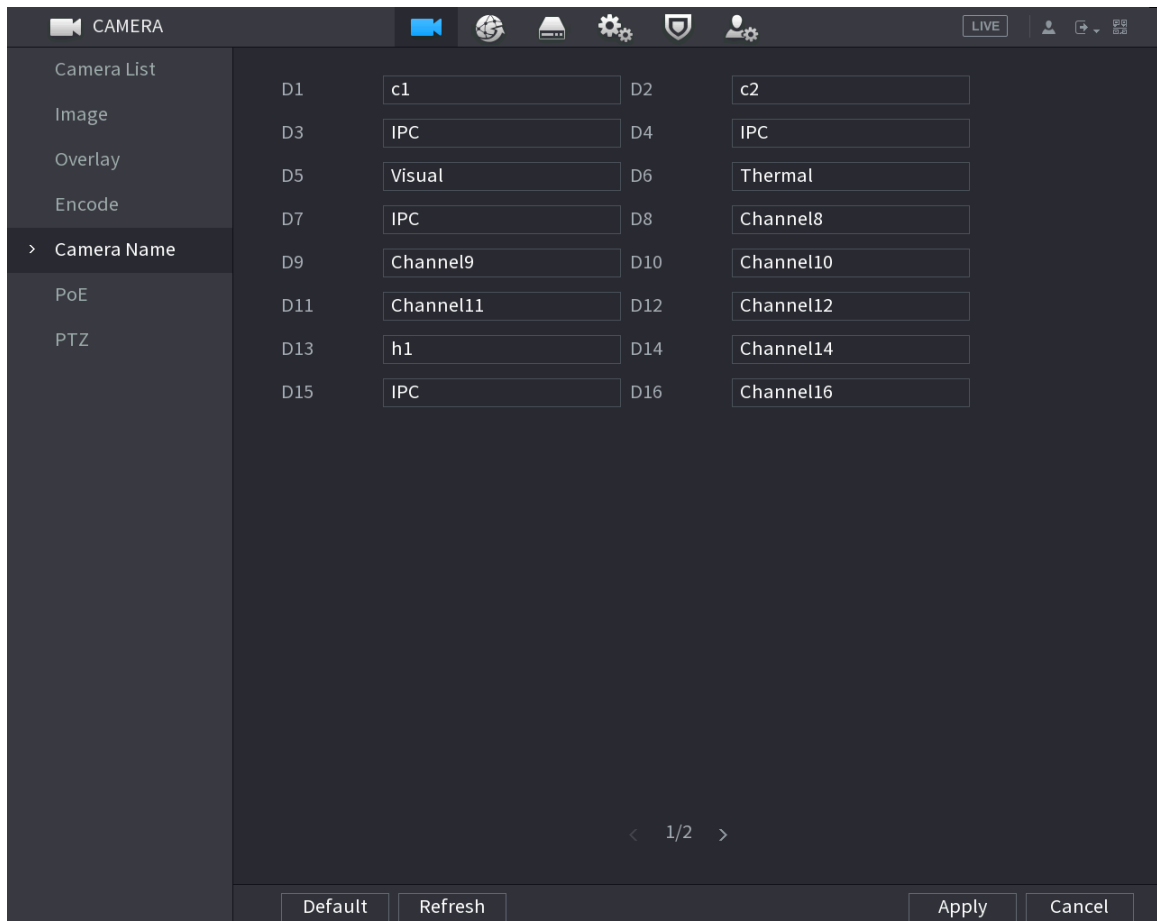

**Step 2** Modify a channel name.



- You can only change the name of the camera connected via the private protocol.
- You can enter up to 63 English characters for a channel name.

**Step 3** Click Apply.

## 5.7.8 Checking the PoE Status

You can check the status of PoE ports and set enhancement mode for each PoE port.

### Procedure

**Step 1** Select Main Menu > CAMERA > PoE.

Figure 5-64 PoE

Connected/Total		0/16	Actual/Total Power(W)		0.0/150.0
Status	Port	Link Quality	Enhancement Mode	Rate(Mbps)	Power(W)
<span style="color: red;">●</span>	1	0	Off	-	-
<span style="color: red;">●</span>	2	0	Off	-	-
<span style="color: red;">●</span>	3	0	Off	-	-
<span style="color: red;">●</span>	4	0	Off	-	-
<span style="color: red;">●</span>	5	0	Off	-	-
<span style="color: red;">●</span>	6	0	Off	-	-
<span style="color: red;">●</span>	7	0	Off	-	-
<span style="color: red;">●</span>	8	0	Off	-	-
<span style="color: red;">●</span>	9	0	Off	-	-

Note:

- About icon : for PoE connection status, green circle means the device is connected and red circle means the device is disconnected ;
- Power protection function : Once the system detects the connected total power consumption exceeds the threshold, it begins to disconnect device one by one according to the port number (N~1). System stops disconnecting when the total power consumption is restored to rated power ;
- Link quality : It mainly contains three levels: poor, average and good. Try to enable signal enhancement mode when the link quality is poor.

**Step 2** (Optional) Set Enhancement Mode to On or Off.



When enhancement mode is enabled, the transmission distance of the PoE port will be extended.

## 5.7.9 Updating Remote Devices

### Background Information

You can update the firmware of the connected network camera through online update or file update.

### Procedure

**Step 1** Select Main Menu > CAMERA > Camera List > Update.

Figure 5-65 Update

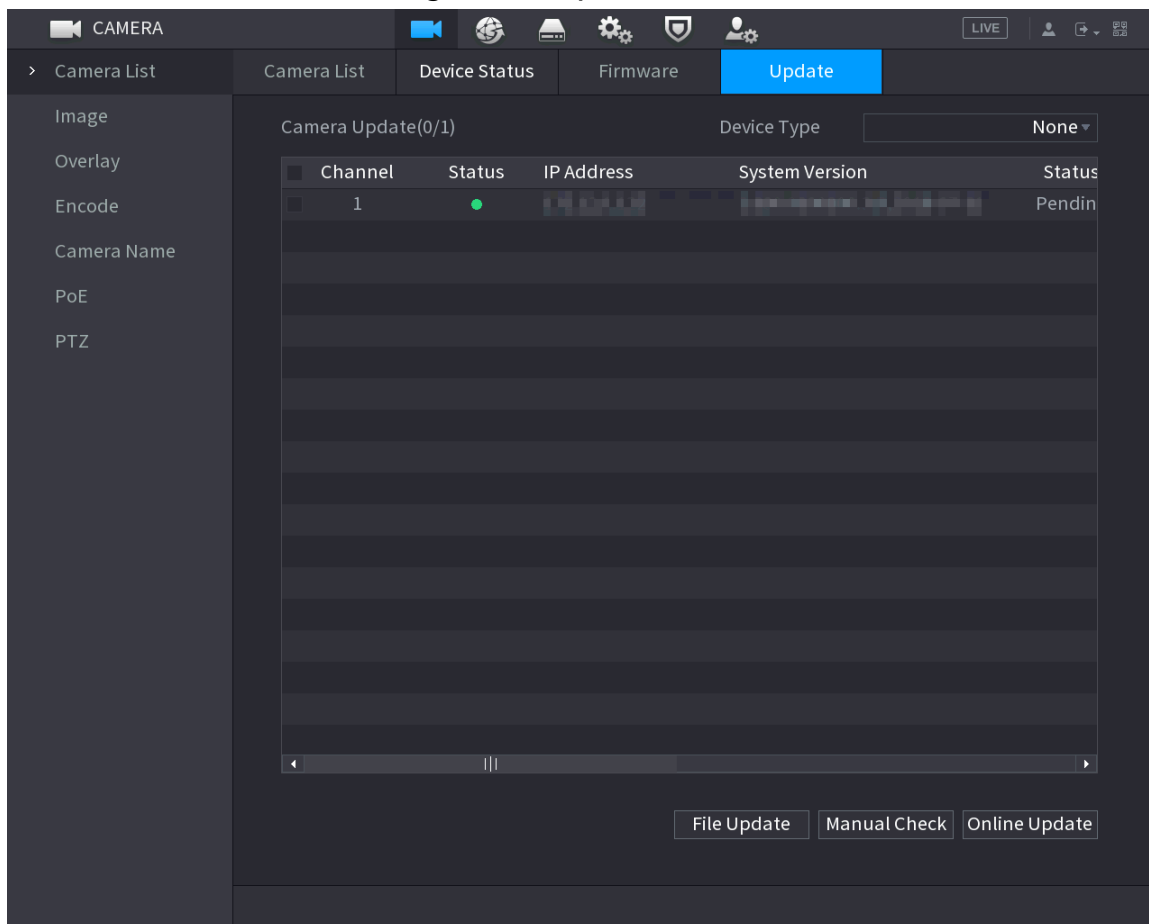

**Step 2** Update the firmware of the connected remote device.

- Online update.

1. Select a remote device and then click Manual Check

.The system checks for available updates.

2. Select a remote device that has an update available for it, and then click Online Update.

- File update.

1. Select a channel and then click File Update.

2. Select an update file.

3. Click OK.



If there are too many remote devices, you can filter them on the Device Type list.

## 5.7.10 Viewing Remote Device Information

### 5.7.10.1 Device Status

You can view the connection and alarm status of the corresponding channel.

Select Main Menu > CAMERA > Camera List > Device Status.

Figure 5-66 Device status

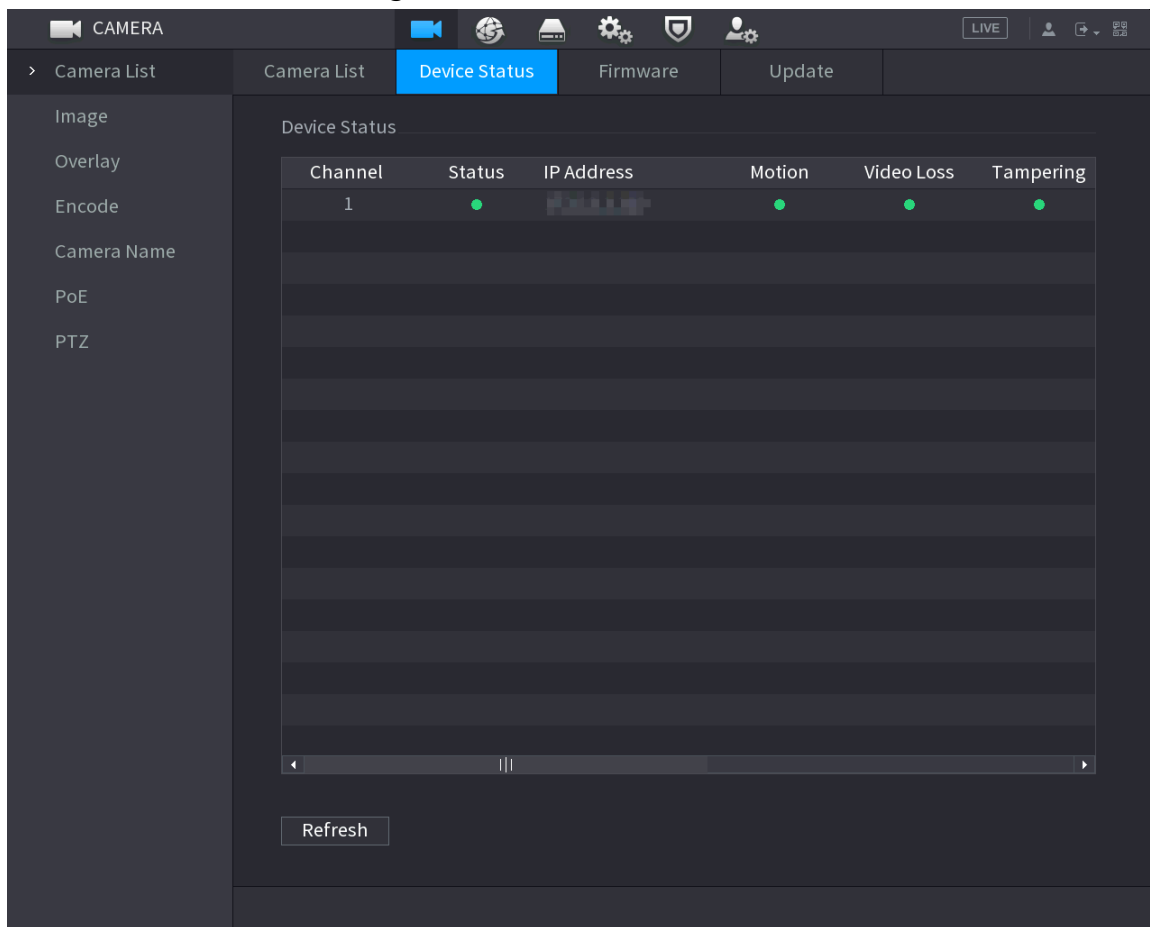

Table 5-21 Parameters of device status

Icon	Description	Icon	Description
	IPC works properly.		IPC is not supported.
	Alarm.		Video loss.

### 5.7.10.2 Firmware

You can view the IP address, manufacturer, type, and system version of the connected remote device.

Select Main Menu > CAMERA > Camera List > Firmware.





Figure 5-68 Video schedule

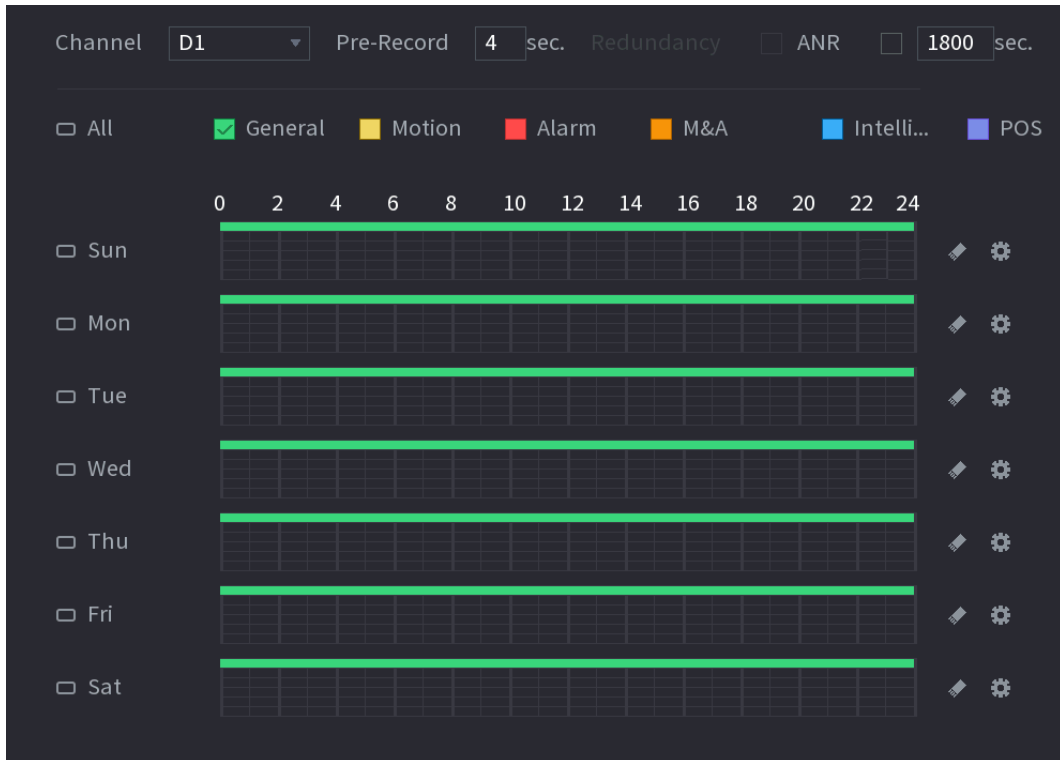

**Step 2** Configure the parameters.

Table 5-22 Video schedule parameters

Parameter	Description
Channel	Select a channel to record a video.
Pre-record	Enter the amount of time that you want the pre-recording to last. A recording will be made prior to the event.



Parameter	Description
Redundancy	<p>If there are several HDDs installed to the Device, you can set one of the HDDs as the redundant HDD to save the recorded files into different HDDs. If one of the HDDs becomes damaged, you can find the backup on the other HDD.</p> <ul style="list-style-type: none"> <li>• Select Main Menu &gt; STORAGE &gt; Disk Manager, and then set a HDD as redundant HDD.</li> <li>• Select Main Menu &gt; STORAGE &gt; Schedule &gt; Record, and then select the Redundancy checkbox.                             <ul style="list-style-type: none"> <li>◇ If the selected channel is not recording, the redundancy function will take effect the next time that you record, whether or not you select the checkbox.</li> <li>◇ If the selected channel is recording, the current recorded files will be packed, and then start recording according to the new schedule.</li> </ul> </li> </ul> <p> This function is for some models only.</p> <ul style="list-style-type: none"> <li>• The redundant HDD only backs up the recorded videos but not snapshots.</li> </ul>
ANR	<p>You can set the ANR (auto network resume) function.</p> <ul style="list-style-type: none"> <li>• The IPC continues recording once the NVR and IPC connection fails. After the network becomes normal, the NVR can download recording files while it is disconnected from the IPC. This is to help protect against data loss from the current IPD channel that is connected.</li> <li>• Set the maximum recording upload period. If the offline period is longer than the period you set, IPC will only upload the recording file during the specified period.</li> </ul> <p> Make sure that SD card is installed and the recording function is enabled on the IPC.</p>
Period	<p>Set a period during which the configured recording setting is active.</p> <p> The system only activates the alarm in the defined period.</p>
Copy to	<p>Click Copy to to copy the settings to other channels.</p>

Figure 5-69 Period



**Step 3** Set one or more recording types from General, Motion (motion detection), Alarm, M&A (motion detection and alarm), Intelligent and Alarm.

Figure 5-70 Recording type

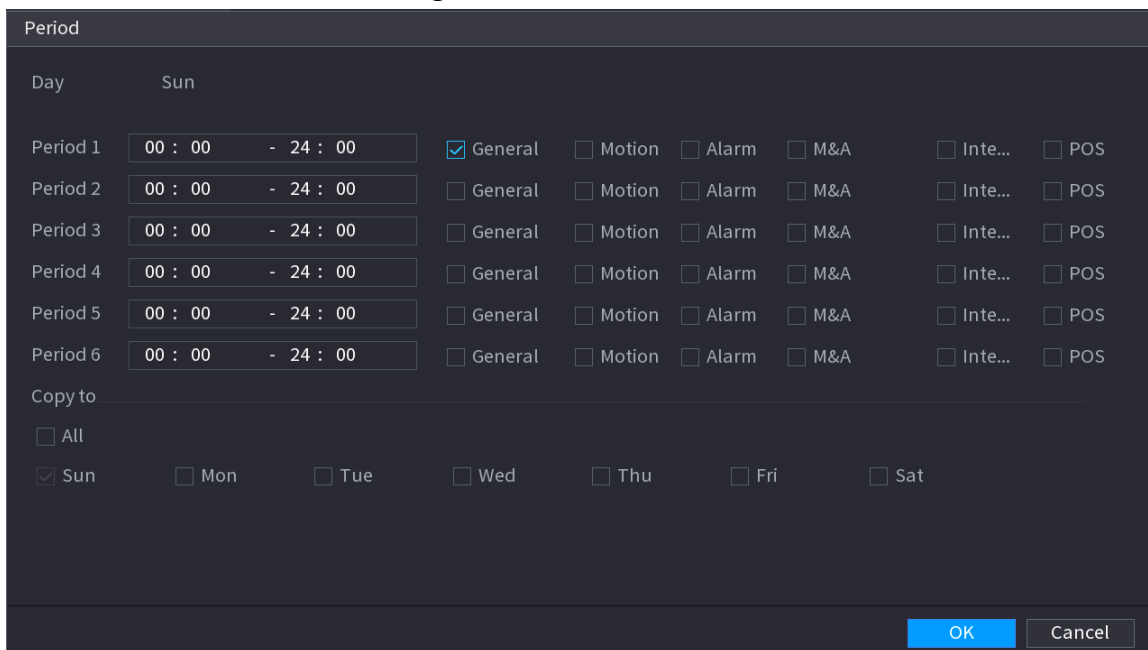
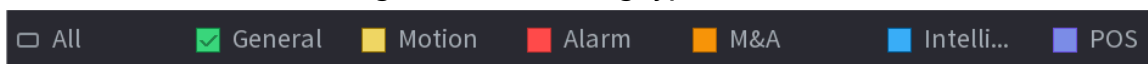

**Step 4** Set recording period.



If you have added a holiday, you can set the recording period for the holiday.

Figure 5-71 Set record period

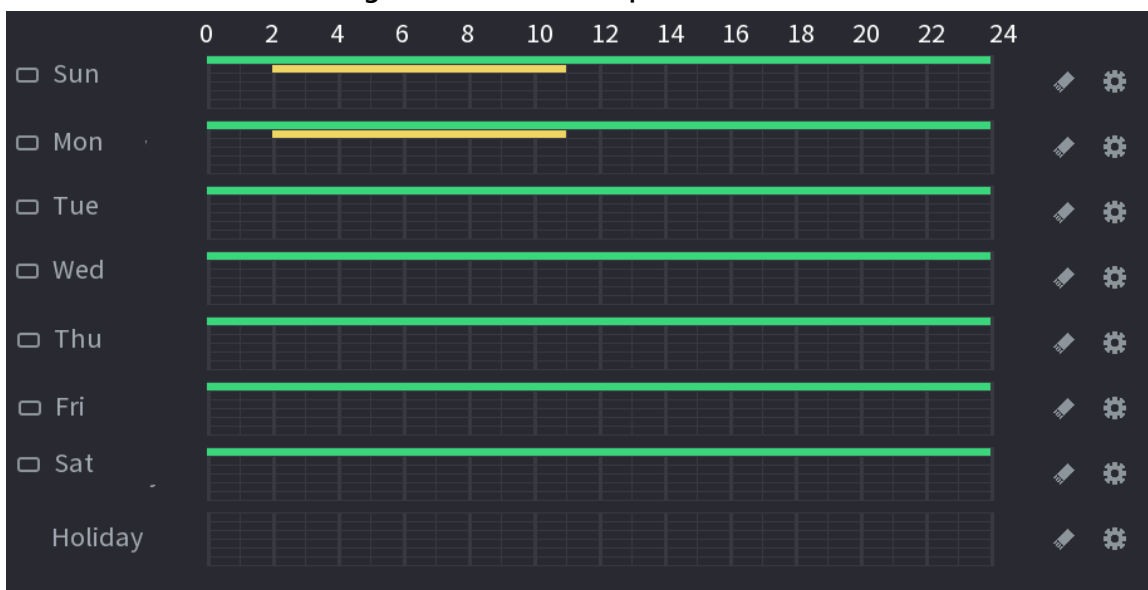

- Define the period by drawing.
  1. Select a corresponding date to set.
    - ◇ Define for the whole week: Click  next to All. All the icon switch to .

You can define the period for all the days simultaneously.

- ◇ Define for several days of a week: Click before each day one by one. The icon switches to . You can define the period for the selected days simultaneously.
2. On the timeline, drag to define a period.
- ◇ Once the time period overlaps, the recording priority is: M&A > Alarm > POS > Intelligent > Motion > General.
  - ◇ Select a recording type and then click the of the corresponding date to clear the corresponding period.

Figure 5-72 Set period by drawing



The MD record and alarm record function are both null if you enabled MD&Alarm function.

- Define the period by editing.
  1. Select a date and then click .

Figure 5-73 Set period by editing

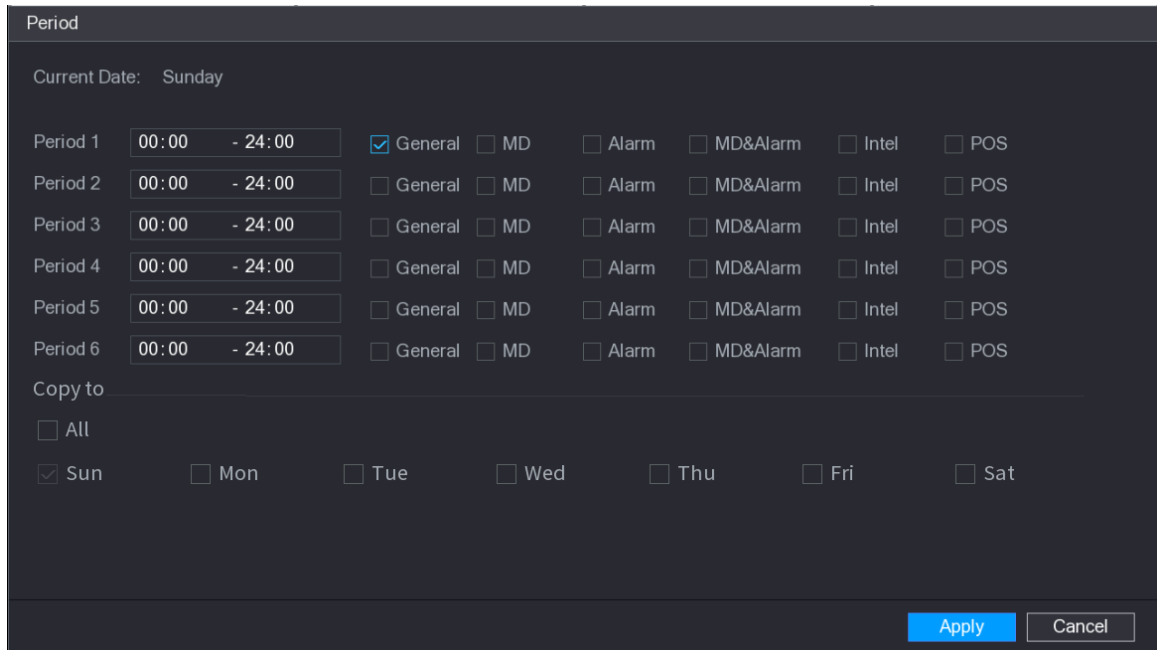

2. Set the recording type for each period.
  - ◇ There are six periods for you to set for each day.
  - ◇ Under Copy to, select All to apply the settings to all the days of the week, or select specific days that you want to apply the settings to.
3. Click Apply.

**Step 5** Click Apply to complete the settings.

### 5.8.1.2 Configuring Snapshot Schedule

#### Background Information

Configure recording schedule for snapshots.

#### Procedure

**Step 1** Right-click the live page, and then select Main Menu > STORAGE > Schedule > Snapshot.

Figure 5-74 Snapshot

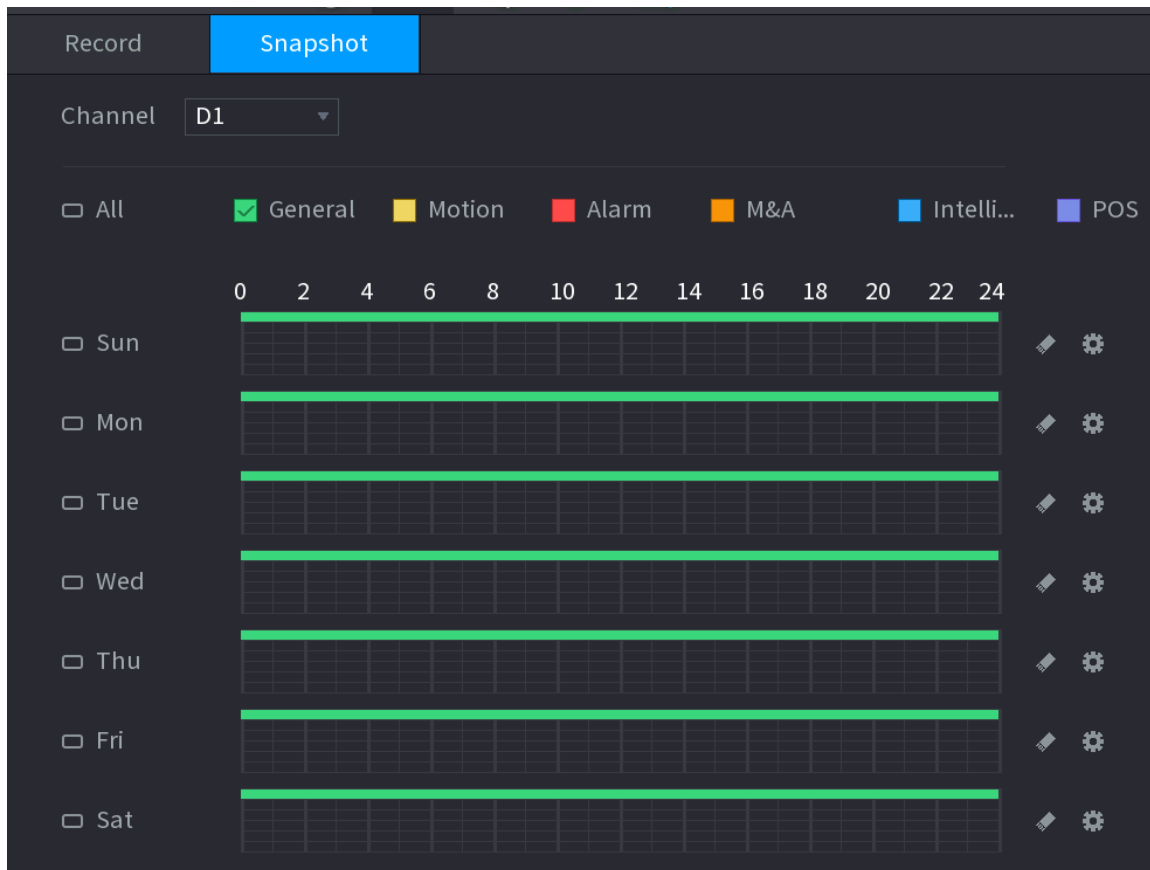

**Step 2** Select a channel to set schedule snapshot.

**Step 3** Set a recording type.

Figure 5-75 Recording type

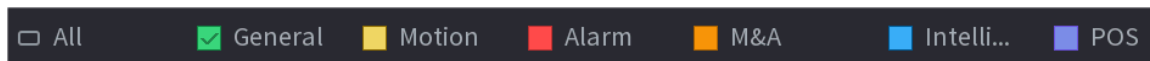

**Step 4** Set snapshot period. For details, see [Step 4](#) in "5.8.1.1 Configuring Video Recording Schedule".

**Step 5** Click Apply.

### 5.8.1.3 Configuring Recording Mode

#### Background Information

After you set schedule record or schedule snapshot, you need to enable the auto record and snapshot function so that the system can automatically record or take snapshot.

- **Auto:** The system automatically records the videos and snapshots according to the defined schedule.
- **Manual:** The system records general files for the entire day.



You need to have storage authorities to use the Manual recording mode.

## Procedure

**Step 1** Right-click the live page, and then select Main Menu > STORAGE > Record.

Figure 5-76 Recording mode

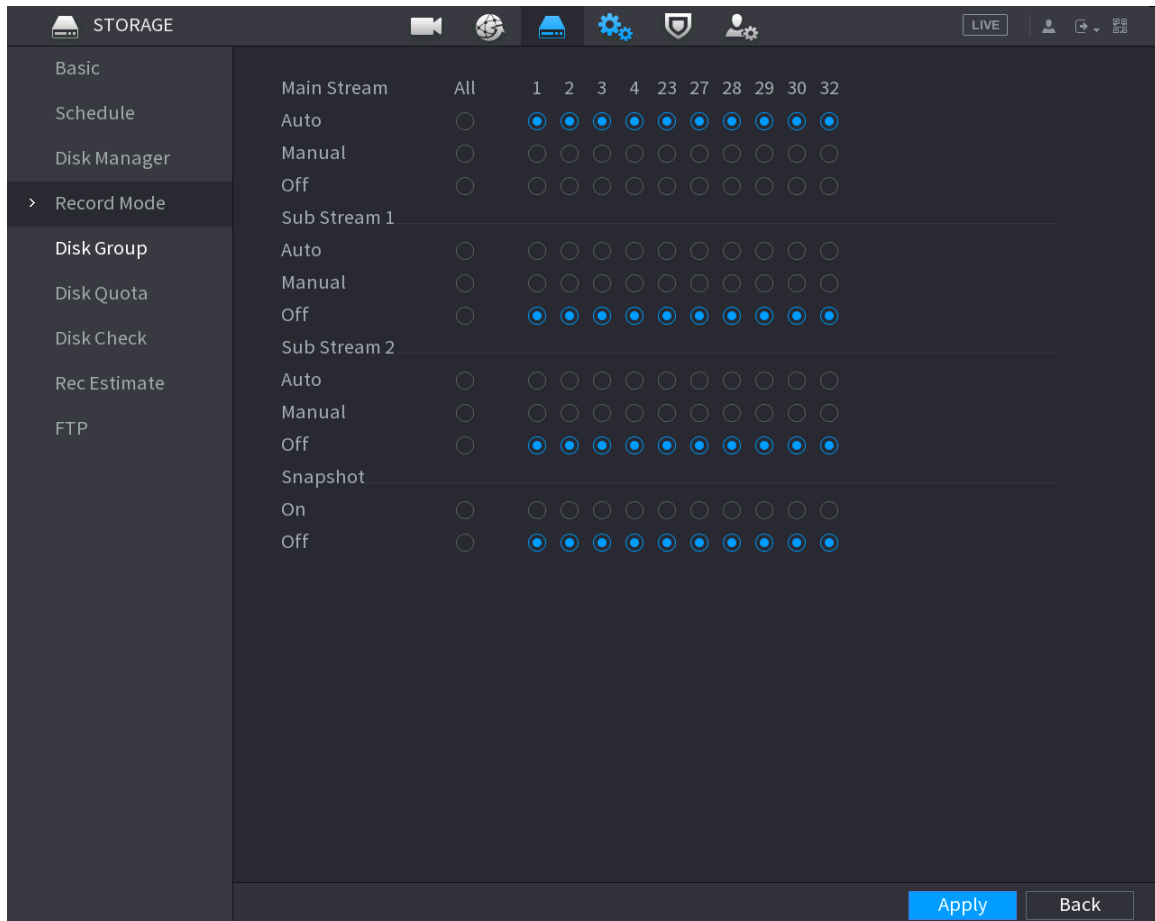

**Step 2** Configure parameters.

Table 5-23 Recording mode parameters

Parameter	Description
Channel	Displays all the connected channels. You can select a single channel or select All.
Recording status	<ul style="list-style-type: none"> <li>• Auto: Automatically make recordings according to the schedule.</li> <li>• Manual: Makes a general recording within 24 hours for the selected channel.</li> <li>• Off: Do not record.</li> </ul>
Snapshot status	Enable or disable the scheduled snapshot for the corresponding channels.

**Step 3** Click Apply.



## 5.8.2 Search and Playback

### 5.8.2.1 Search Page

You can search for and play back the recorded files on the NVR.

Select Main Menu > SEARCH, or right-click on the live view page and then select Search.





The following figure is for reference only.









Figure 5-77 Search



Table 5-24 Search page description

No.	Function	Description
1	Display window	<p>Display the searched recorded video or picture. The system supports playing in single-channel, 4-channel, 9-channel, and 16-channel simultaneously.</p> <p> When playing back in the single-channel mode, hold down the left mouse button to select the area that you want to enlarge. The area is enlarged after the left mouse button is released. To exit the enlarged status, right-click the image.</p>
2	Playback controls bar	Playback control buttons.

No.	Function	Description
	Clip	Click  to clip the recording file and then save the footage. See "5.8.2.4 Clipping Videos" for details.
	Backup	Click  to back up recordings.
3	Time bar	<p>Display the type and time period of the current recorded video.</p> <ul style="list-style-type: none"> <li>• In the 4-channel layout, 4 time bars are displayed. In other view layouts, only 1 time bar is displayed.</li> <li>• Click the colored area to start playback from a certain time.</li> <li>• When you are configuring the settings, rotate the wheel button on the time bar to zoom in from 0. When a playback is being played, rotate the wheel button on the time bar, the time bar will zoom into the time point where the playback is located.</li> <li>• Time bar colors: Green for general type; red for external alarm; yellow for motion detection; blue for intelligent events; purple for POS events.</li> <li>• Click and hold the time bar, and the mouse pointer changes to a hand icon, and then you can drag to view the playback of the target time.</li> <li>• You can drag the vertical orange line on the time bar to rapidly view the playback in iframe format.</li> <li>• When playing back a video in one channel mode, point to the time bar for 0.1 seconds, and then you can view 4 pictures before and after the selected time, and the thumbnail picture of the selected time.</li> <li>• For some models, when you click the blank area in the time bar, the system automatically jumps to the next time point where there is a recorded video located.</li> </ul>
4	Play status	Includes 2 playback status: Play and Stop.
	Record type	Select the checkbox to define the recording type to search for.
5	Search type	Select the content to play back: Record, Picture, and Subperiod.

No.	Function	Description
6	Calendar	<p>Click the date that you want to search for.</p>  <p>The dates with recordings or snapshots have a small solid circle under the date.</p>
7	View layout and channel selection	<ul style="list-style-type: none"> <li>• In the Camera Name list, select one or more channels that you want to play back.</li> <li>• The window split is decided by how you select the channels. For example, if you select 1 channel, the playback is displayed in the single-channel view. If you select two to four channels, the playback is displayed in the four-channel view. The maximum is eight channels.</li> <li>• Click  to switch the streams.  indicates main stream, and  indicates sub stream.</li> </ul>
8	List display	<p>This area includes Tag List and File List.</p>  <p>The icons displayed might vary with models.</p> <ul style="list-style-type: none"> <li>• : Click Tag List to view the marked recorded video list. Double-click the file to start playing.</li> <li>• : Click File List to view the files that were found. You can lock and unlock the files. See "5.8.2.6 File List" for detailed information.</li> <li>• : fisheye dewarp. See "5.6.10.2 Fisheye De-warp During Playback " for detailed information.</li> </ul>
9	Time bar unit	<p>You can select 24 hr, 2 hr, 1 hr, or 30 min as the unit of time bar.</p>



All the operations for playback might vary with hardware versions. Some functions are available on select models.

## 5.8.2.2 Playback

### Background Information

You can search for and play back videos, images or video clips. The operations are similar. This section uses video playback as an example.

### Procedure

**Step 1** Select Main Menu > Search, or right-click the live page and then select Search.

**Step 2** Select From R/W Disk or From I/O Device.

- From R/W Disk: Search for recorded files on the HDD of the Device.

Figure 5-78 Search from R/W disk

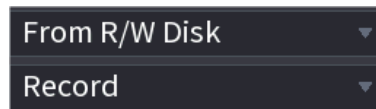

- From I/O Device: Search for recorded files from external storage device. Click Browse, select the storage path of the recorded video file that you want to play. Double-click the video file or click ▶ to start playing.

Figure 5-79 Search from I/O device

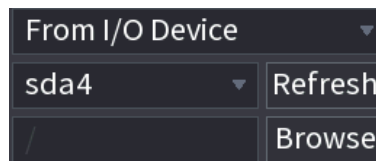

**Step 3** Select Record as the search type.

**Step 4** Select the date, and channel.

**Step 5** Click ▶ or any position on the time bar.













The system starts playback. You can use the playback controls to control the playback process.

Figure 5-80 Playback control



Table 5-25 Playback control description

Icon	Function
	Play/Pause In slow play mode, click it to switch between play/pause.
	Stop When playing back, click to stop current playback process.
	Rewind In normal play mode, left-click the button, the file begins to rewind. Click it again to pause it. While it is rewinding, click  or  to restore normal play.
	Display previous frame/next frame. When you pause the normal playback file, click  or  to play back frame by frame. In frame by frame playback mode, click  or  to resume normal playback mode.
	Slow play In playback mode, click it to use various slow play modes such as slow play 1, slow play 2, and more.

Icon	Function
	<p>Fast forward</p> <p>In playback mode, click to realize various fast play modes such as fast play 1, fast play 2 and more.</p>
	<p>Adjust the volume of the playback.</p>
	<p>Smart search.</p> <p>See "5.8.2.3 Smart Search Playback" for detailed information.</p>
	<p>Smart motion detection. You can click the icon to select a human or motor vehicle, and the system plays detected videos of the person or motor vehicle.</p> <p></p> <p>Human and motor vehicle can be selected at the same time.</p>
	<p>Click the snapshot button in the full-screen mode to take one snapshot. System supports custom snap picture saved path. Connect the peripheral device first, click snap button on the full-screen mode, you can select or create a path. Click Start button, the snapshot picture can be saved to the specified path.</p>
	<p>Mark button.</p> <p>This function is available on select models. Make sure there is a mark button in the playback control pane.</p> <p>See "5.8.2.7 Tag Playback" for detailed information.</p>
	<p>Display and hide POS information.</p> <p>In 1-channel playback mode, you can click it to display/hide POS information on the video.</p>
	<p>In 1-channel playback mode, click it to enable or disable display IVS rule information on the video.</p> <p></p> <p>This function is for some series only.</p>
	<p>Picture search. For details, see "5.6.3.7 Picture Search".</p>
	<p>Quick pick. For details, see "5.6.3.8 Quick Pick".</p>

## 5.8.2.3 Smart Search Playback

### Background Information



This function is for some models only.

During the playback process, the system can analyze the motion detection zone in the scene and give the analysis result.



Make sure that motion detection has been enabled in Main Menu > ALARM > Video Detection > Motion Detection.

### Procedure

**Step 1** Select a channel to playback video and then click . You can view the grids on the playback video.



- This function is for one-channel playback mode.
- In multiple-channel playback mode, double-click a channel to switch to one-channel playback mode.

**Step 2** Select smart search zones (22\*18(PAL), 22\*15(NTSC)).

**Step 3** Click  to go to smart search and playback. The system is going to play back all motion detection record footage.

**Step 4** Click  again to stop smart search.



- The motion detection region cannot be the full screen zone.
- The motion detection region adopts the current whole play pane by default.
- The time bar unit switch, rewinding, frame by frame are not available when the system is playing a motion detection file.

## 5.8.2.4 Clipping Videos

### Background Information

You can clip some footage from recorded videos to a new file and then save to the USB device.

### Procedure

**Step 1** Select a record first and then click  to play back.

**Step 2** Select a time on the time bar and then click  to start clip.

**Step 3** Select a time on the time bar and then click  to stop clip.

**Step 4** Click , the system pops up dialogue box to save the clip file.

Figure 5-81 Clip

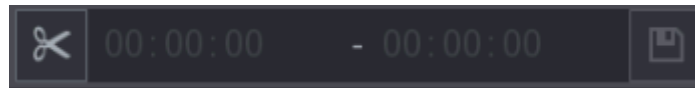

### 5.8.2.5 Backing Up

#### Background Information

You can back up recorded videos, images, or video clips to a USB storage device.

#### Procedure



- Step 1** Select the files that you want to back up.
- Videos or images. Click  at the lower-right corner of the search page, and then on the file list, select the files for backup.
  - Video clips. See "5.8.2.4 Clipping Videos".
- Step 2** Click .

Figure 5-82 Backup





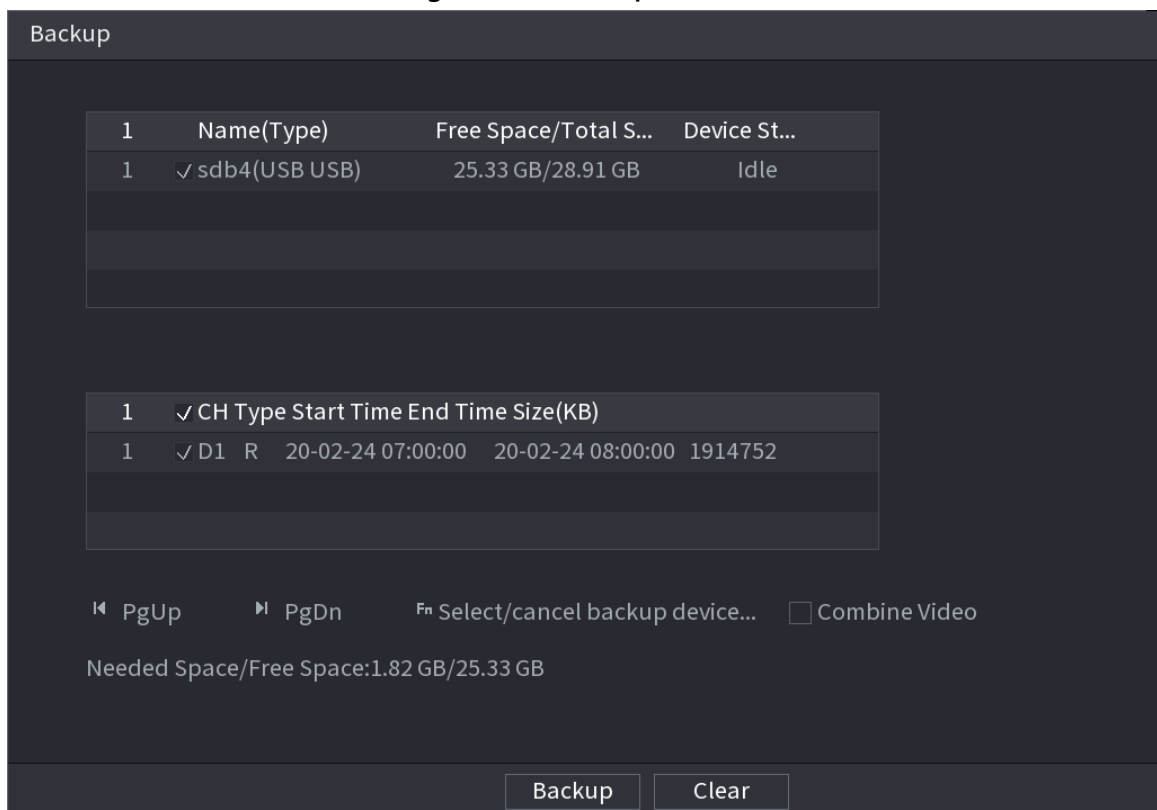

- Step 3** Select the storage device, and then click Backup.



- You can cancel the selection of the files that you do not want to back up.
- Select Combine Video to merge several videos into one.

### 5.8.2.6 File List

On the search page, select a channel, and then click  to view the file list. On the file list, you can manage the files of the selected channel.

- Play.  
Double-click a file to play.
- Search.  
Select a specific time and then click .
- Lock or unlock files.
  - ◇ To lock files, on the file list, select one or more files, and then click . The locked files will not be overwritten.
  - ◇ To unlock files, click  and then select one or more files and then click Unlock.
- Go back to the previous page.  
Click  to return to the page with calendar.

### 5.8.2.7 Tag Playback

When you are playing back a video, you can add a tag to mark an important point in time on the video. After playback, you can use time or the tag keywords to search for the corresponding video and then play.

#### Adding Tag

When the system is playing back, click , and then configure the tag name.

#### Playing back Tag

During single-channel playback, click , and then on the tag list, double-click a file to play back.



To search for tagged videos by time, select the tag time and then click .

#### Playing before Tagged Time

You can choose to play back from the previous N seconds of the tag time.





The system can play back previous N seconds before the tagged time if there is a video at that point. Otherwise, the system plays back as much as there is.

## Managing Tags

On the tag list, click .

Figure 5-83 Tag management

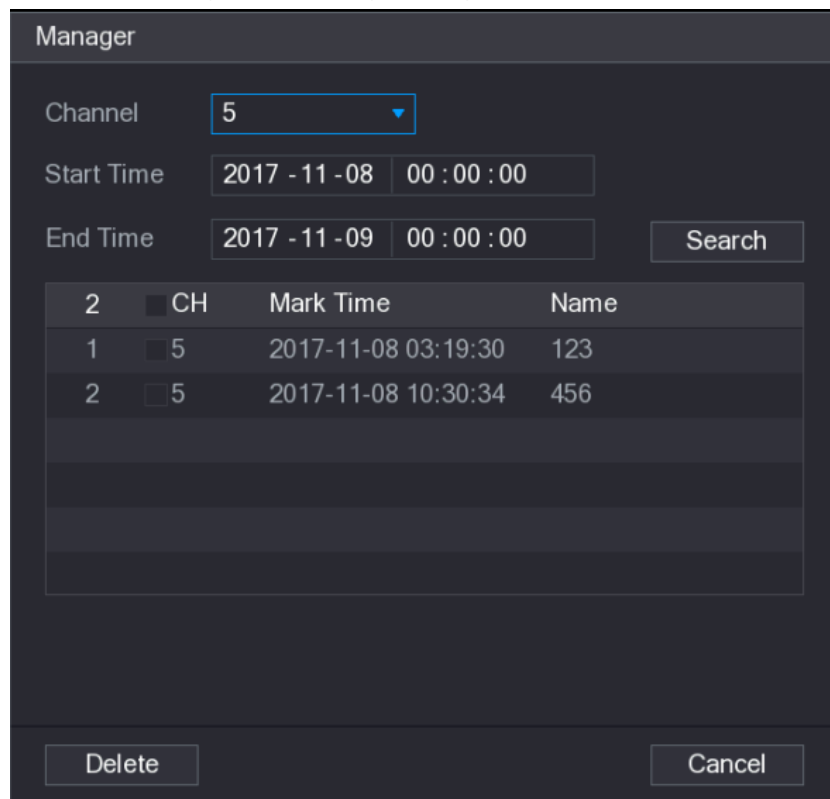

2	CH	Mark Time	Name
1	5	2017-11-08 03:19:30	123
2	5	2017-11-08 10:30:34	456

- To search for the tagged video, select channel number, start time and end time, and then click Search.
- To change the tag name, double-click a tagged video, and then enter the new name.
- To delete tags, select one or more tagged videos, and then click Delete.

### 5.8.3 Recording Information

Select Main Menu > MAnalytics+NTAnalytics+N > System Info to view the recording information.

Figure 5-84 Recording information

Version	Disk	Record	BPS	Legal Info
Device Name	Start Time	End Time		

## 5.9 Analytics+

Analytics+ detection is to process and analyze the image and extract the key information, and then compare the key information with the preset detection rule. An alarm is triggered when the detected behavior matches the detection rule.



The following figures are for reference only and might differ from the actual situation.

### 5.9.1 Overview

Analytics+ detection falls into Analytics+ by camera and Analytics+ by recorder.

- **Analytics+ by camera:** Some cameras themselves support Analytics+ detection. The cameras perform Analytics+ detection and send the detection results to the NVR for display. When using Analytics+ by camera, make sure to connect the Device to the cameras that support the corresponding Analytics+ detection functions.
- **Analytics+ by recorder:** The cameras send videos to NVR for detection, analysis and result display.



- Some models support Analytics+ by camera only.
- The Analytics+ functions might vary with models.
- Different Analytics+ functions might conflict with each other. You cannot enable two conflicting Analytics+ functions for the same channel.

## 5.9.2 Smart Plan

### Background Information

To use Analytics+ by camera for face detection, Face Detection+ and other detection functions, you need to enable the corresponding smart plan first.

### Procedure

**Step 1** Select Main Menu > Analytics+ > Parameters > Smart Plan.

**Step 2** Select a channel.



The page might differ depending on which smart plans that the remote device supports.

Figure 5-85 Smart plan

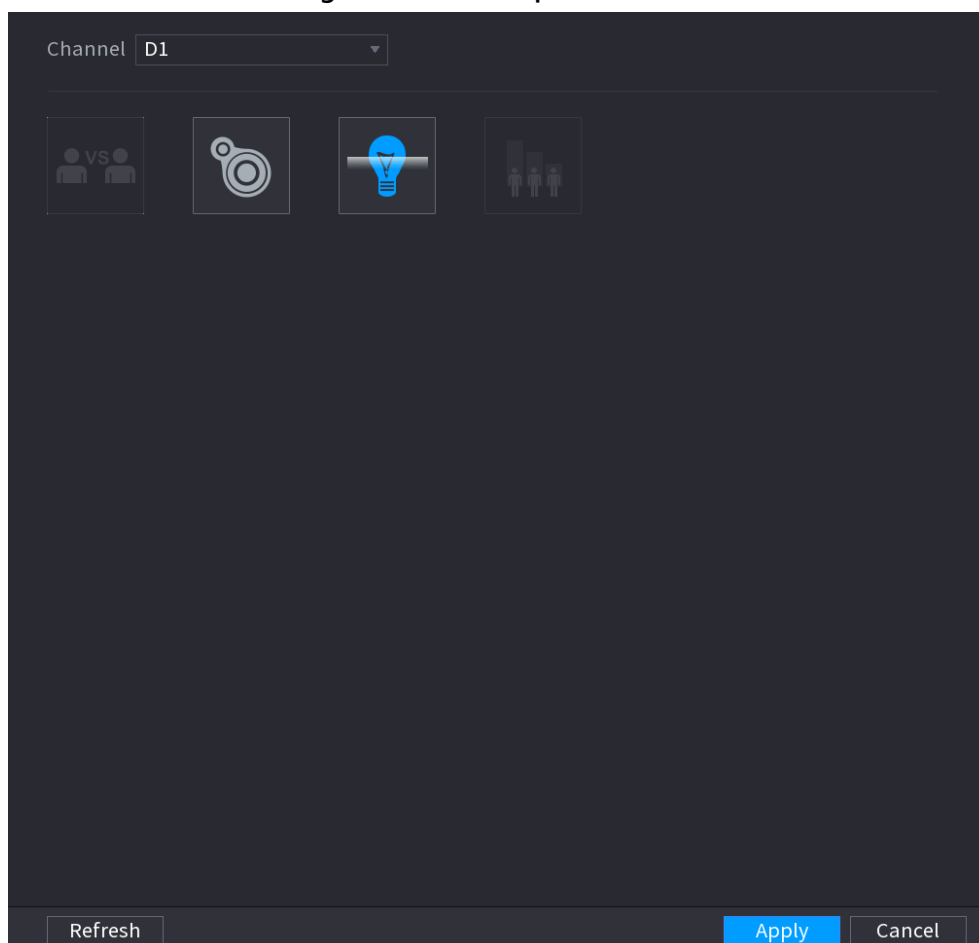

**Step 3** Click the icon that represents the smart plan to enable it. The icon becomes highlighted.



If the channel is connected to a PTZ camera, you can set smart plans separately for each preset point.

Figure 5-86 Smart plan (PTZ)

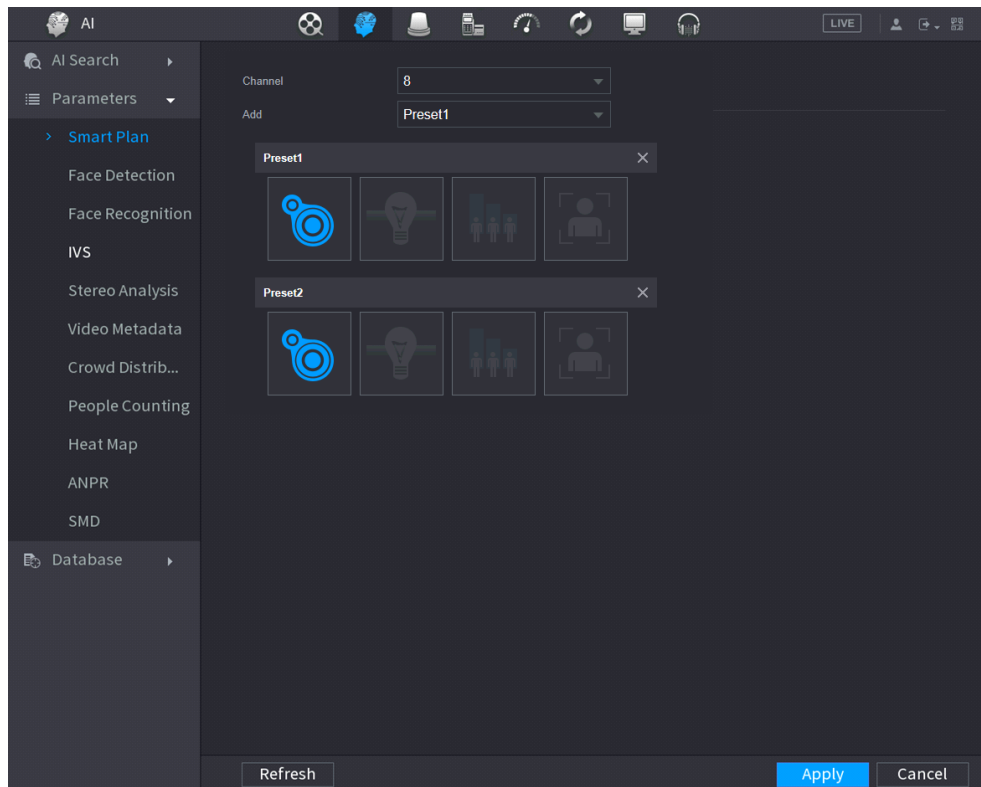

**Step 4** Click Apply.

## 5.9.3 Face Detection

The Device can detect faces on the video image.

### 5.9.3.1 Enabling Smart Plan

To use Analytics+ by camera, you need to enable the smart plan first. For details, see "5.9.2 Smart Plan".

### 5.9.3.2 Configuring Face Detection

#### Background Information

Configure alarm rules for face detection.

## Procedure

**Step 1** Select Main Menu > Analytics+ > Parameters > Face Detection.

Figure 5-87 Face detection

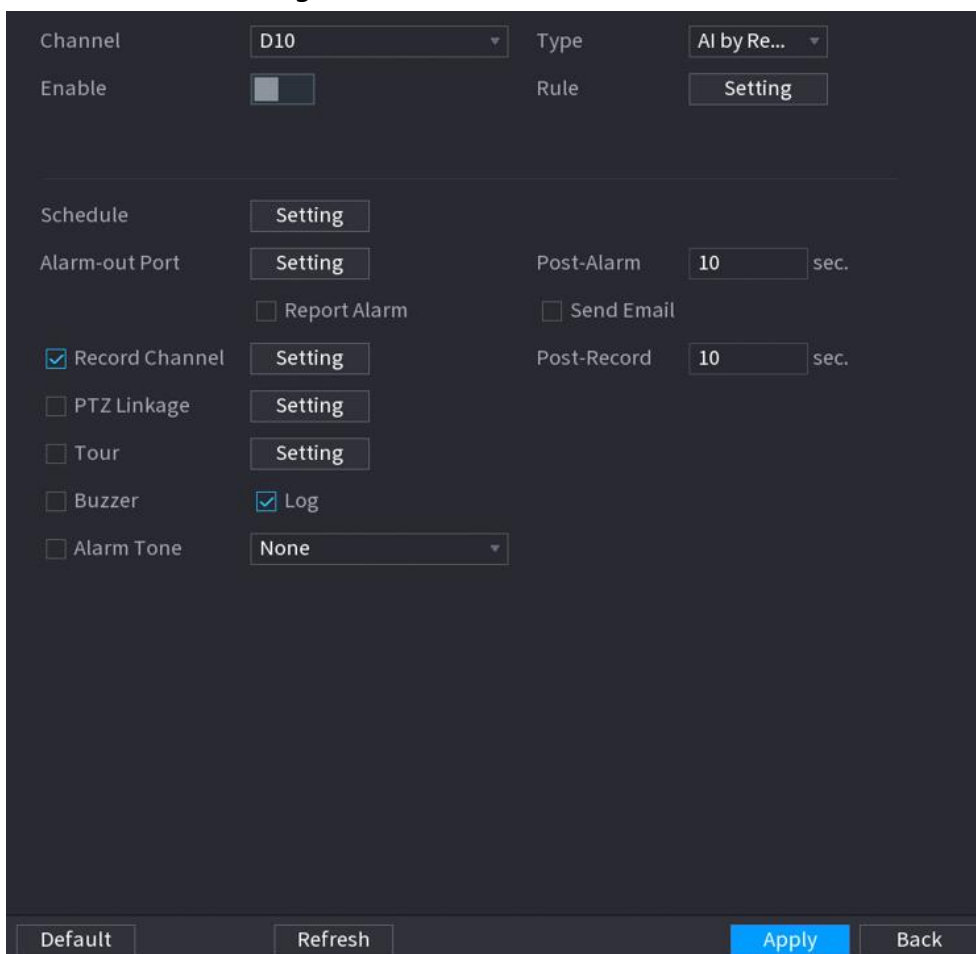

**Step 2** Select a channel, and then select Analytics+ by Reorder or Analytics+ by camera as Type.



When Analytics+ by camera is selected, you can enable Face Enhancement to improve face detection efficiency.

**Step 3** Click  to enable face detection.

**Step 4** Click Setting next to Rule to draw areas to filter the target.

You can configure two target filters (maximum size and minimum size). The system triggers an alarm when the size of detected target is between the maximum size and the minimum size.

**Step 5** Click Setting next to Schedule to configure the arming period.

The system triggers corresponding alarm actions only during the arming period.

- On the time line, drag to set the period.
- You can also click  to set the period.

**Step 6** Configure alarm linkage actions. For details, see [Step7](#).

**Step 7** Click Apply.

### 5.9.3.3 Analytics+ Search (Face Detection)

#### Background Information

You can search for the detected faces and play back related recordings.

#### Procedure

**Step 1** Select Main Menu > Analytics+ > Analytics+ Search > Face Detection.

Figure 5-88 Face search

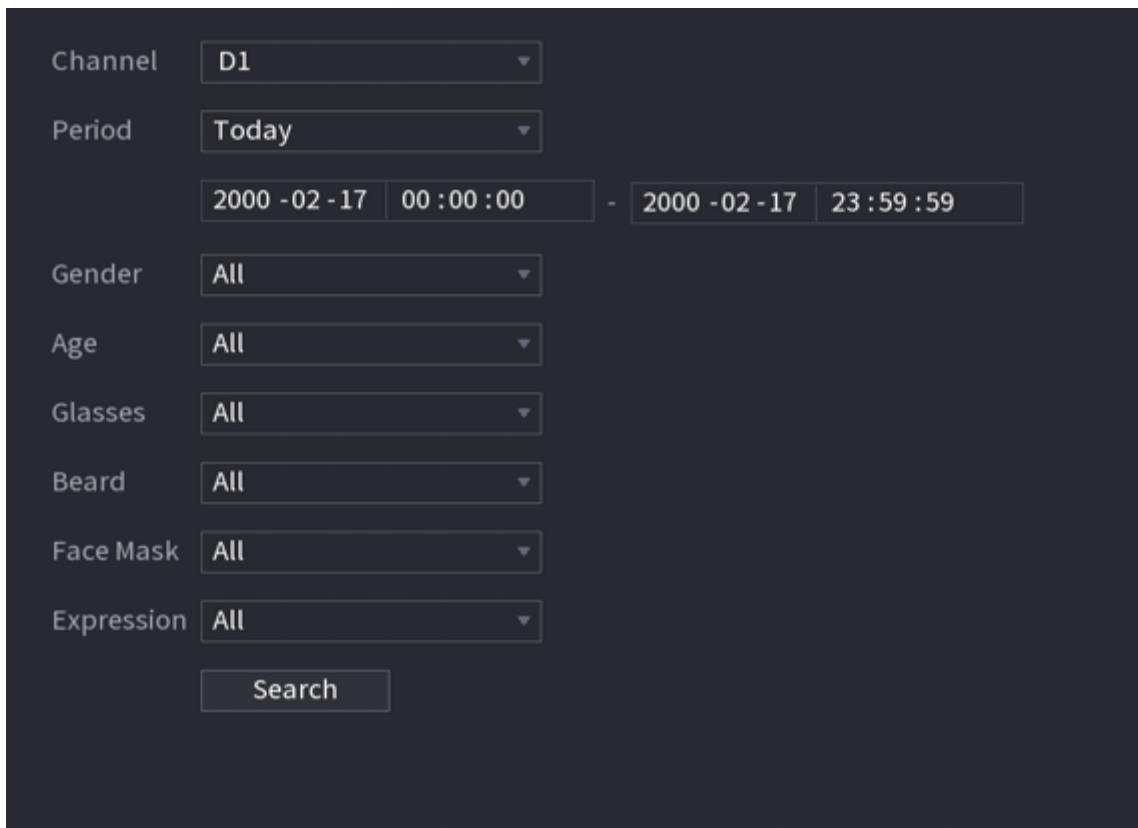

The screenshot shows a dark-themed search interface with the following elements:

- Channel:** A dropdown menu with 'D1' selected.
- Period:** A dropdown menu with 'Today' selected.
- Time Range:** Two input fields for start and end times, with '2000 -02 -17 00 :00 :00' and '2000 -02 -17 23 :59 :59' entered, separated by a hyphen.
- Attributes:** A series of dropdown menus for 'Gender', 'Age', 'Glasses', 'Beard', 'Face Mask', and 'Expression', all with 'All' selected.
- Search Button:** A rectangular button labeled 'Search' at the bottom.

**Step 2** Select the channel, enter the start time and end time, and select the attributes.

**Step 3** Click Search.

The results are displayed.



For privacy reason, the human faces in the image are intentionally blurred. The actual image is clear.

Figure 5-89 Search results

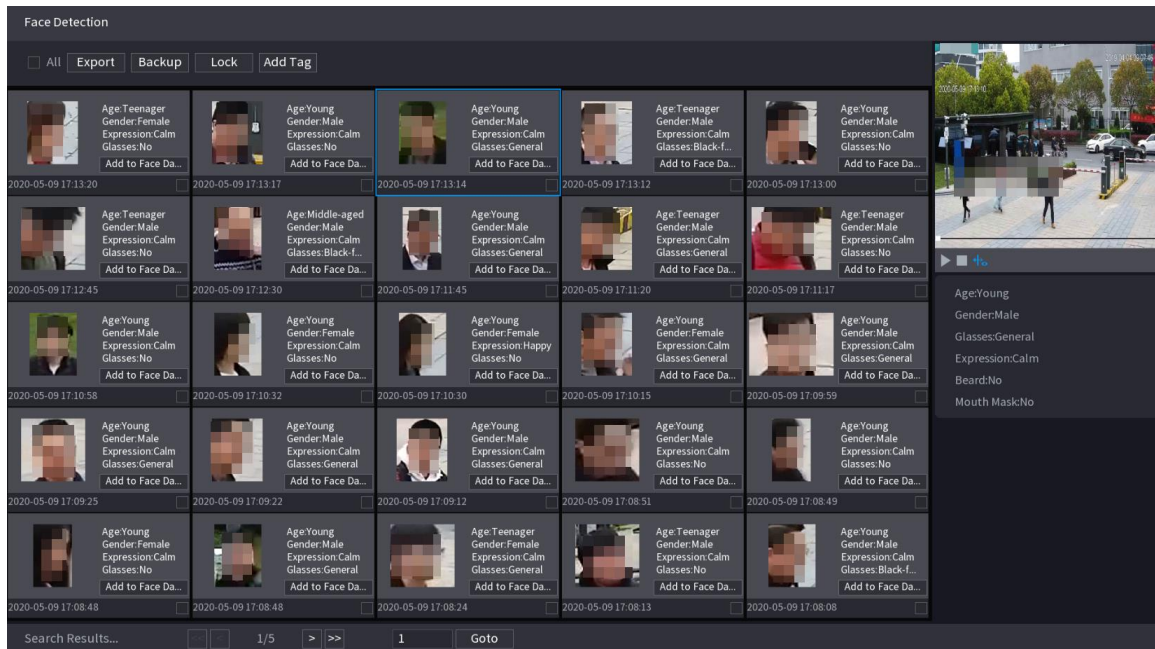

## Related Operations

- **Play related video.**  
Click a face and then click . The system plays back the video around the snapshot time.
- **Export.**  
Click Export to export results in Excel format.
- **Back up.**  
Select one or more images, click Backup, select the storage path and file type, and then click Start to back up the selected files to an external storage device.
- **Lock.**  
Select one or more images and then click Lock. The locked files will not be overwritten.
- **Add tags.**  
Select one or more images and then click Add Tag.
- **Add to face database.**  
Click Add to Face Database, enter corresponding information, and then add the image to the face database.

Figure 5-90 Add face image to database

Register

Name

Gender  Male  Female

Birthday Year  M  D

Province

Crede... ID Card

Region

Add...

Cre...

1	Name	Register No.	Failed No.	Error No.
1	1	0	0	0

## 5.9.4 Face & Body Detection

After enabling face & body detection, you can view the face and body snapshots and related attributes on the live page.

### 5.9.4.1 Enabling Smart Plan

To use Analytics+ by camera, you need to enable the smart plan first. For details, see "5.9.2 Smart Plan".

### 5.9.4.2 Configuring Face & Body Detection

#### Background Information

Configure alarm rules for face and body detection.

#### Procedure

**Step 1** Select Main Menu > Analytics+ > Parameters > Face Detection.



Figure 5-91 Face and body detection

**Step 2** Select a channel, and then click  to enable the function.

**Step 3** Enable Face & Body Image Enhancement to improve detection efficiency.

**Step 4** Configure target filters.

You can configure two target filters (maximum size and minimum size). The system triggers an alarm when the size of detected target is between the maximum size and the minimum size.

**Step 5** Click Setting next to Schedule to configure the arming period.

The system triggers corresponding alarm actions only during the arming period.

- On the time line, drag to set the period.
- You can also click  to set the period.

**Step 6** Configure alarm linkage actions. For details, see [Step7](#).

**Step 7** Click Apply.

### 5.9.4.3 Analytics+ Search (Face & Body Detection)

To search for face detection results, see "5.9.3.3 Analytics+ Search (Face Detection)". To search for body detection results, see "5.9.8.3.1 Human Detection".

### 5.9.5 Face Detection+

The system compares the detected faces with the faces in the database to judge whether the detected face belongs to the database. When the similarity reaches the defined threshold, an alarm is triggered.

### 5.9.5.1 Enabling Smart Plan

To use Analytics+ by camera, you need to enable the smart plan first. For details, see "5.9.2 Smart Plan".

### 5.9.5.2 Creating Face Database

Create face databases to manage face images for Face Detection+.

#### 5.9.5.2.1 Creating Local Face Databases

You can create face databases on the Device to manage face images for Face Detection+ by Device.

#### Procedure

**Step 1** Select Main Menu > Analytics+ > Database > Face Database Config.

Figure 5-92 Face database configuration

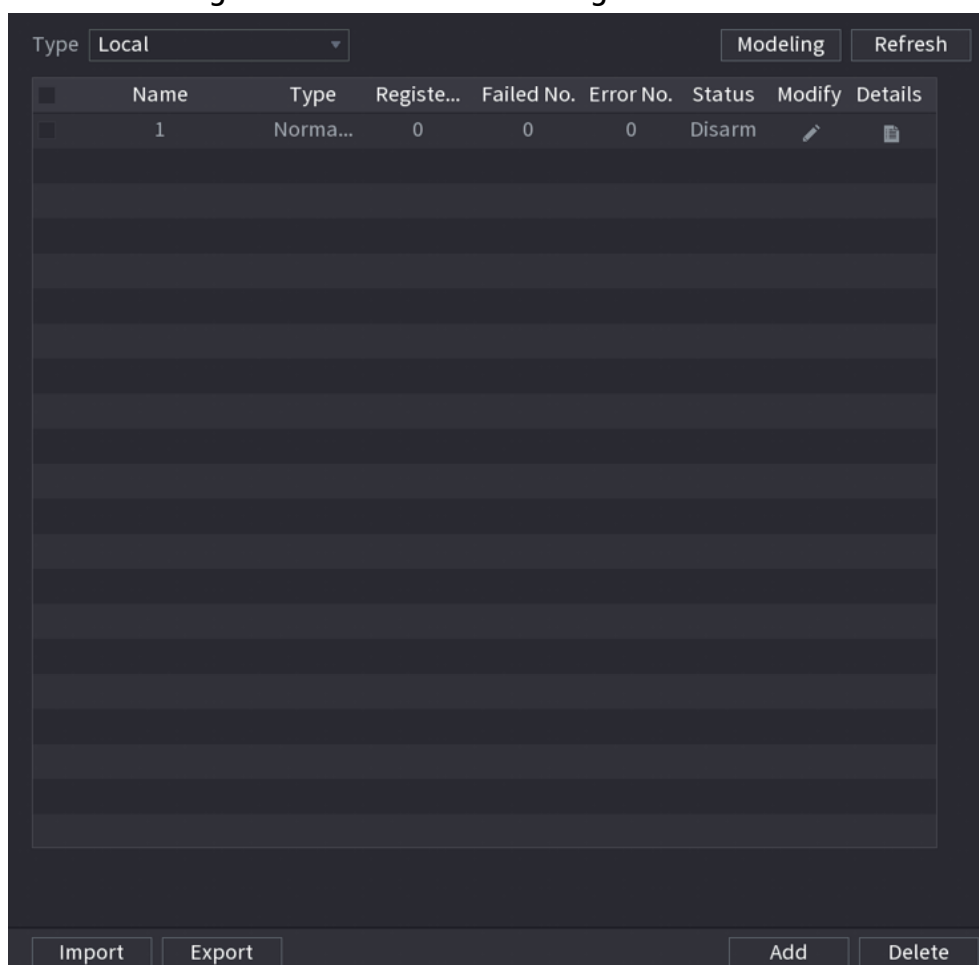

**Step 2** Select Local as Type, and then click Add.

Figure 5-93 Add database

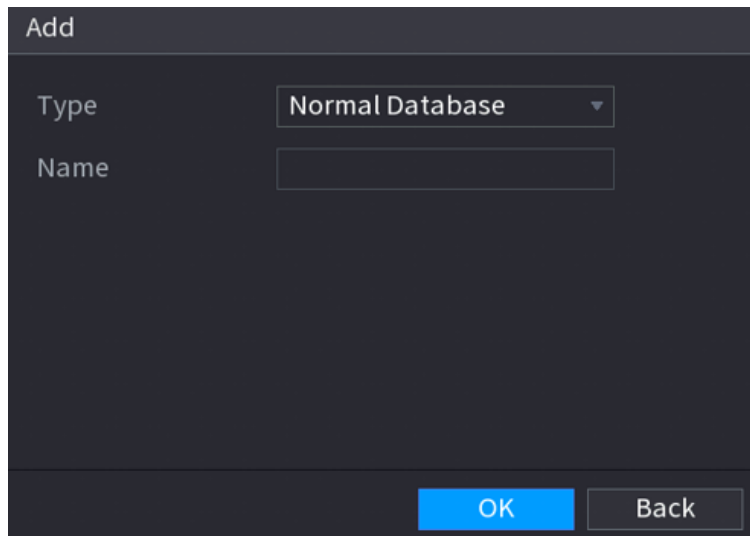

**Step 3** Select Normal Database from the Type list, and then enter database name.

**Step 4** Click OK.

#### 5.9.5.2.2 Creating Remote Face Databases

The Device can get face databases from the remote devices, and also allows creating face databases for remote devices. The remote device face database is suitable for Face Detection+ by Camera.

#### Procedure

**Step 1** Select Main Menu > Analytics+ > Database > Face Database Config.

**Step 2** Select Remote as Type, select a channel and then click Add.

**Step 3** Enter database name.

**Step 4** Click OK.

#### 5.9.5.2.3 Creating the Passerby Database

#### Background Information

If you use the passerby database for alarm linkage, when the detected face is not in the face database, the system automatically captures the face image, and then save it to the passerby database.



This function is available on select models.

#### Procedure

**Step 1** Select Main Menu > Database > Face Database Config.

**Step 2** Select Local as Type, and then click Add.



You can create only one passerby database.

Figure 5-94 Add database

**Step 3** Select Passerby Database from the Type list, and then configure other parameters.

Table 5-26 Passerby database parameters

Parameter	Description
Name	Enter a name for the passerby database.
Number of Images	Configure the number of images that the database can contain.
Storage Full	Select the storage strategy when space is full. <ul style="list-style-type: none"> <li>• Stop: No more images can be added.</li> <li>• Overwrite: The newest images overwrite the oldest images. Back up the old images as necessary.</li> </ul>
Time	Set the period in which the system removes duplicate face images from the database.

**Step 4** Click OK.

### 5.9.5.3 Adding Images to Face Database

You can add face images to the existing databases one by one or in batches.

#### 5.9.5.3.1 Adding Face Images One by One

#### Background Information

You can add one face image to the database. It is for the scenario that the registered human face picture amount is small.

#### Procedure

**Step 1** Select Main Menu > Analytics+ > Database > Face Database Config.

**Step 2** Click  of the database that you want to configure.

Figure 5-95 Databases details



**Step 3** Click Register.

Figure 5-96 Register

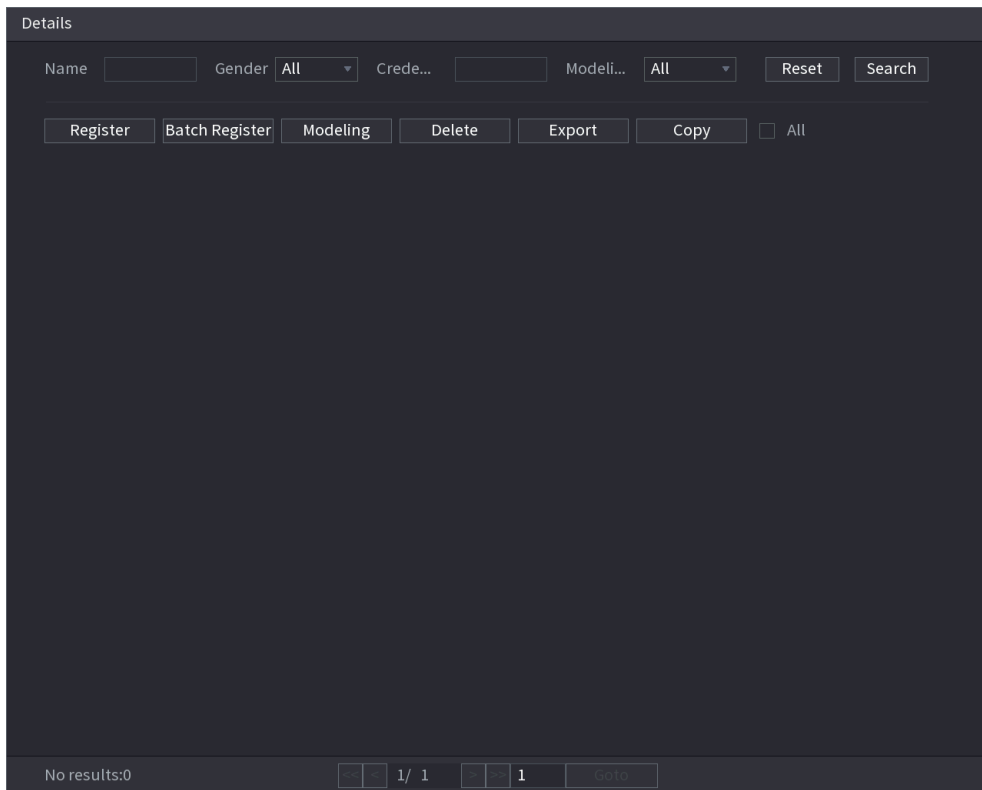
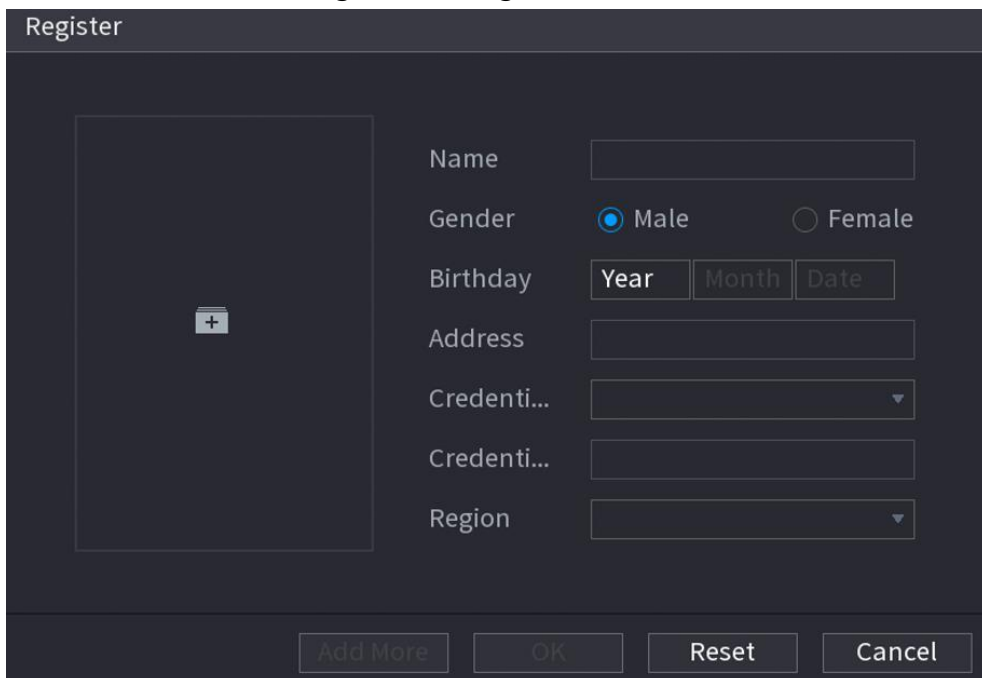

**Step 4** Click  to add a face image.

Figure 5-97 Browse



**Step 5** Select a face image and then enter the registration information.

**Step 6** Click OK.

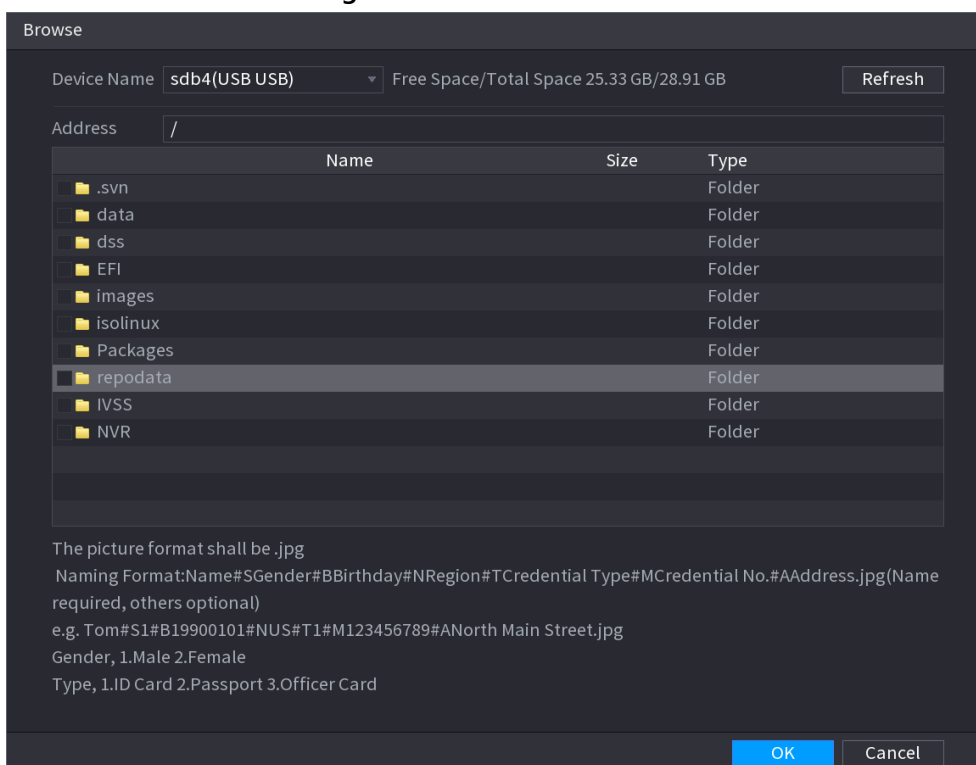
The system prompts the registration is successful.

**Step 7** On the Details page, click Search.

The system prompts modeling is successful.



If the system prompts modeling is in process, wait a while and then click Search again. If modeling failed, the registered face image cannot be used for Face Detection+.

## Related Operations

- Edit registration information.

Click  to modify the registration information.

- Model face images.

The face images are modeled automatically after added to face database. You can also model face images manually.

- ◇ On the Database Config page, select a database, and then click Modeling to model all the face images in the database.
- ◇ On the Details page, select one or more face images, and then click Modeling to model the selected images.

- Export face images.

Select one or more face images, and then click Export.

- Delete face images.

Select one or more face images, and then click Delete.

### 5.9.5.3.2 Adding Face Images in Batches

#### Background Information

The system supports batch add if you want to import several human face image at the same time.

#### Procedure

**Step 1** Give a name to the face picture by referring to the following table.

Table 5-27 Naming rule

Naming format	Description
Name	Enter the name.
Gender	Enter 1 or 2. 1 represents male, and 2 represents female.
Birthday	Enter numbers in the format of yyyy-mm-dd.
Region	Enter the abbreviation of region. For example, CN for China.
Credential Type	1 represents ID card; 2 represents passport; 3 represents officer card.
Credential No.	Enter the credential number.
Address	Enter the address.

**Step 2** Select Main Menu > Analytics+ > Database > Face Database Config.

**Step 3** Click  of the database that you want to configure.

**Step 4** Click Batch Register.

Figure 5-98 Batch register

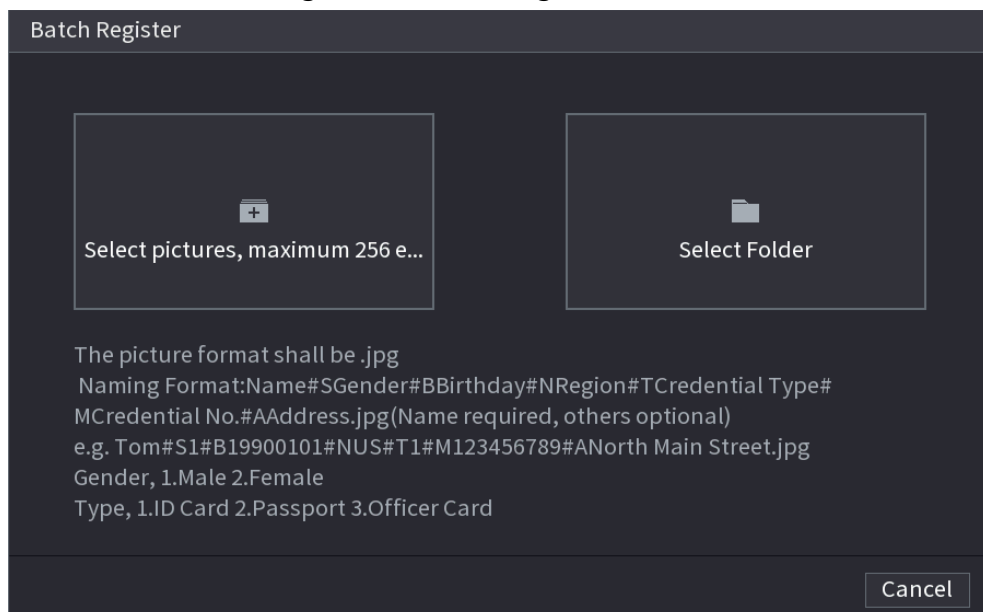

**Step 5** Click  or  to import face images.

**Step 6** Click OK.

## Related Operations

- Edit registration information.  
Click  to modify the registration information.
- Model face images.  
The face images are modeled automatically after added to face database. You can also model face images manually.
  - ◇ On the Database Config page, select a database, and then click Modeling to model all the face images in the database.
  - ◇ On the Details page, select one or more face images, and then click Modeling to model the selected images.
- Export face images.  
Select one or more face images, and then click Export.
- Delete face images.  
Select one or more face images, and then click Delete.

### 5.9.5.4 Configuring Face Detection+

#### Background Information

Configure alarm rules for Face Detection+.

##### 5.9.5.4.1 Configuring Analytics+ by recorder

#### Prerequisites

Make sure the face detection function is enabled at corresponding channel.

#### Procedure

- Step 1 Select Main Menu > Analytics+ > Parameters > Face Detection+.
- Step 2 Select the channel, enable the function, and select Analytics+ by recorder in the Type list.



Figure 5-99 Analytics+ by recorder

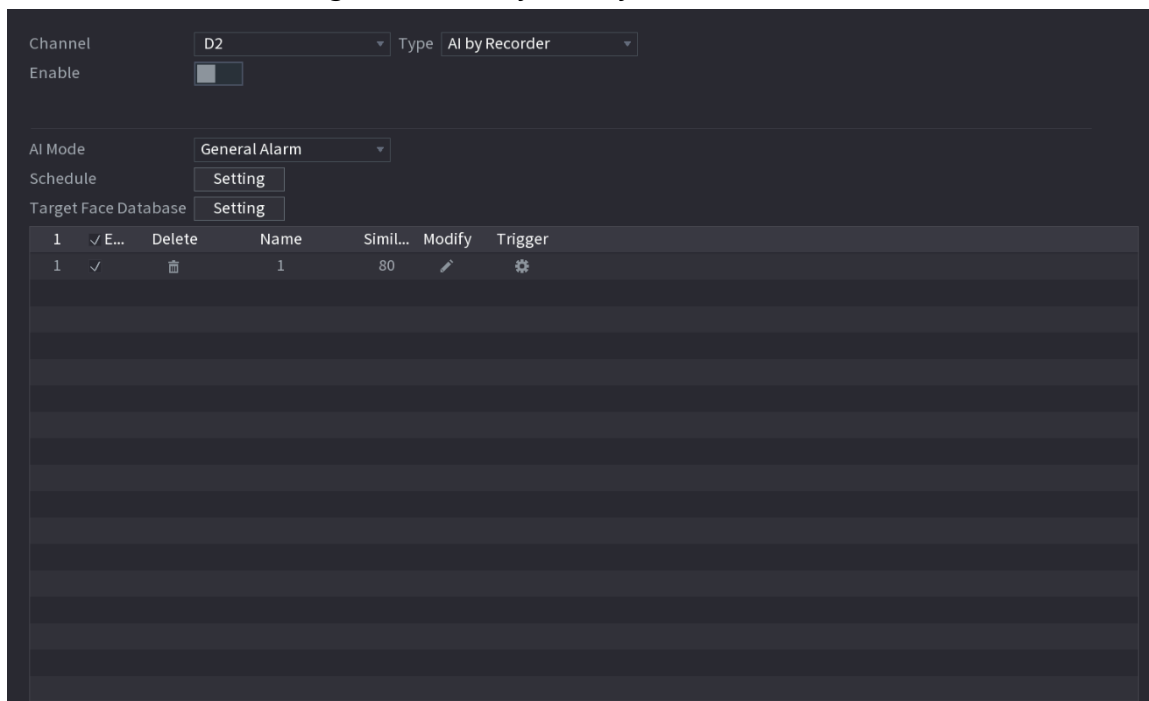

**Step 3** Click Setting next to Schedule to configure arming periods. The corresponding alarm actions are linked by the alarm events triggered during armed period.

**Step 4** Arm target face database.



- General Alarm: The alarm is triggered when the similarity of detected faces reaches the defined value.
  1. Select General Alarm in Analytics+ Mode.
  2. Click Setting next to Target Face Database.
  3. Select the face database that you want to arm, and then click OK.
  4. Click  to modify similarity.
  5. Click  to configure alarm linkages.
- Stranger Alarm: The alarm is triggered when the similarity of detected faces does not reach the defined value.

Figure 5-100 Stranger alarm (Analytics+ by recorder)



1. Select Stranger Alarm in Analytics+ Mode.
2. Click  enable the function.
3. Configure the alarm linkage actions. For details on alarm linkage, see Table 5-43.

**Step 5** Click Apply.

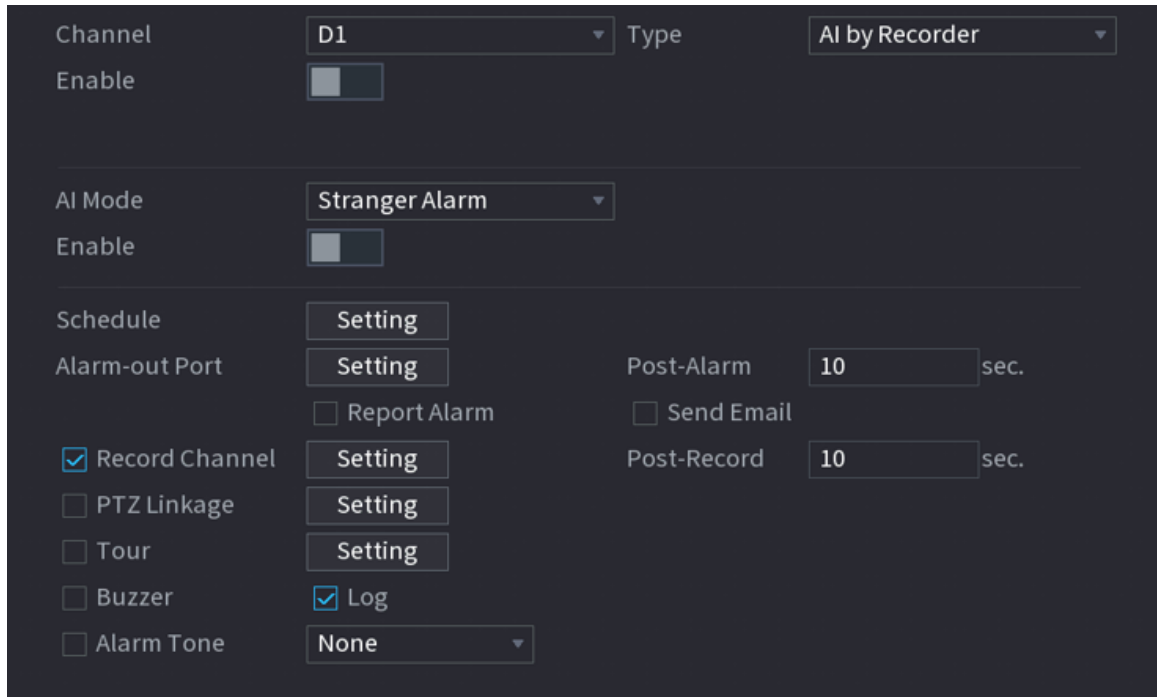
#### 5.9.5.4.2 Configuring Analytics+ by camera

##### Prerequisites

Make sure the connected camera supports Face Detection+.

##### Procedure

**Step 1** Select Main Menu > Analytics+ > Parameters > Face Detection+.

**Step 2** Select the channel, enable the function, and select Analytics+ by camera in the Type list.

Figure 5-101 Analytics+ by camera

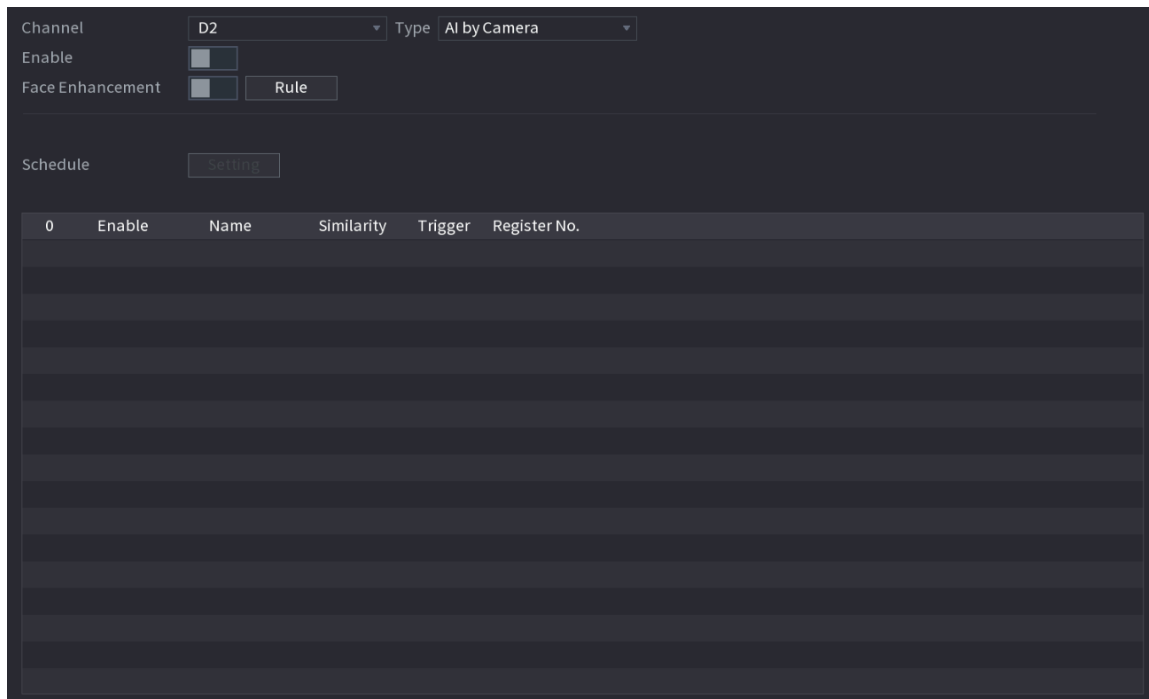

**Step 3** Enable Face Enhancement to make the faces displayed more clear.

**Step 4** Click Rule to draw areas to filter the target.

You can configure two target filters (maximum size and minimum size). When the target is smaller than the minimum size or larger than the maximum size, no alarms will be activated.

**Step 5** Select target face database, and then click  to configure alarm linkage. For details on alarm linkage, see Table 5-43.

**Step 6** Click Apply.

## 5.9.5.5 Analytics+ Search (Face Detection+)

You can search for the Face Detection+ results by attributes or by image.

### 5.9.5.5.1 Search by Attributes

#### Procedure

**Step 1** Select Main Menu > Analytics+ > Analytics+ Search > Face Detection+ > Search by Attributes.

Figure 5-102 Search by attributes

**Step 2** Select the channel and set the parameters including start time, end time, gender, age, glasses, beard, mask, name and similarity.

**Step 3** Click Search.



The faces in the image are intentionally blurred for privacy protection. The actual images are clear.

Figure 5-103 Search results

## Related Operations

- Play back video.

Click an image, and then click  to play back the related video.

During playback, you can:

- ◇ Click to pause.
- ◇ Click to stop.
- ◇ Click to display Analytics+ rule. The icon changes to .
- Add tags.  
Select one or more images, and then click Add Tag.
- Lock.  
Select one or more images, and then click Lock. The locked files will not be overwritten.
- Export.  
Select one or more images, and then click Export to export selected search results in excel.
- Back up.  
Select one or more images, click Backup, select the storage path and file type, and then click Start to export files to external storage device.

### 5.9.5.5.2 Search by Image

#### Procedure

- Step 1** Select Main Menu > Analytics+ > Analytics+ Search > Face Detection+ > Search by Picture.

Figure 5-104 Search by image

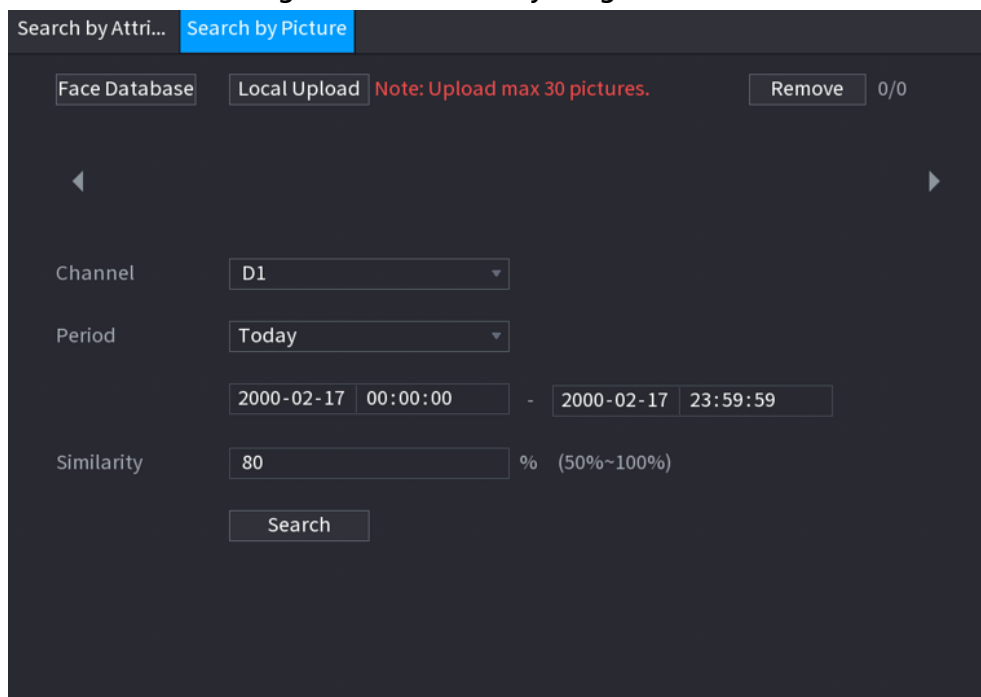

- Step 2** Upload face images.
- Face Database: Upload face images from database.
  - Local Upload: Upload face images from external storage device.
- Step 3** Select the image used to search and then set the parameters including channel,

start time, end time, gender, age, glasses, beard, mask, and similarity.

**Step 4** Click Search.





The search results are displayed.

## Related Operations

- Play back video.

Click an image, and then click  to play back the related video.

During playback, you can:

- ◇ Click  to pause.
  - ◇ Click  to stop.
  - ◇ Click  to display Analytics+ rule. The icon changes to .
- Add tags.  
Select one or more images, and then click Add Tag.
  - Lock.  
Select one or more images, and then click Lock. The locked files will not be overwritten.
  - Export.  
Select one or more images, and then click Export to export selected search results in excel.
  - Back up.  
Select one or more images, click Backup, select the storage path and file type, and then click Start to export files to external storage device.

### 5.9.5.5.3 Report Query

## Background Information

You can search for and export face statistics.



- The statistics might be overwritten when the storage space runs out. Back up in time.
- When you restore the Device to factory settings, all the data except data in the external storage device will be cleared. You can clear the data in the external storage device through formatting or other methods.

## Procedure

**Step 1** Select Main Menu > Analytics+ > Report Query > Face Statistics.

Figure 5-105 Face statistics

**Step 2** Select the report type, start time and end time, and then click Search.

## Related Operations

- Switch chart type.  
Click Bart Chart or Line Chart to switch the chart type.
- Export.  
Select file type, and then click Export to export the report in picture or csv format.

## 5.9.6 IVS

The IVS function processes and analyzes the images to extract the key information to match the specified rules. When the detected behaviors match the rules, the system activates alarms.



- This function is available on select models.
- IVS and face detection cannot be enabled at the same time.

### 5.9.6.1 Enabling Smart Plan

To use Analytics+ by camera, you need to enable the smart plan first. For details, see "5.9.2 Smart Plan".

## 5.9.6.2 Configuring IVS

### 5.9.6.2.1 Tripwire

#### Background Information

When the detection target crosses the warning line along the set direction, the system performs an alarm linkage action.

#### Procedure

**Step 1** Select Main Menu > Analytics+ > Parameters > IVS.

Figure 5-106 IVS

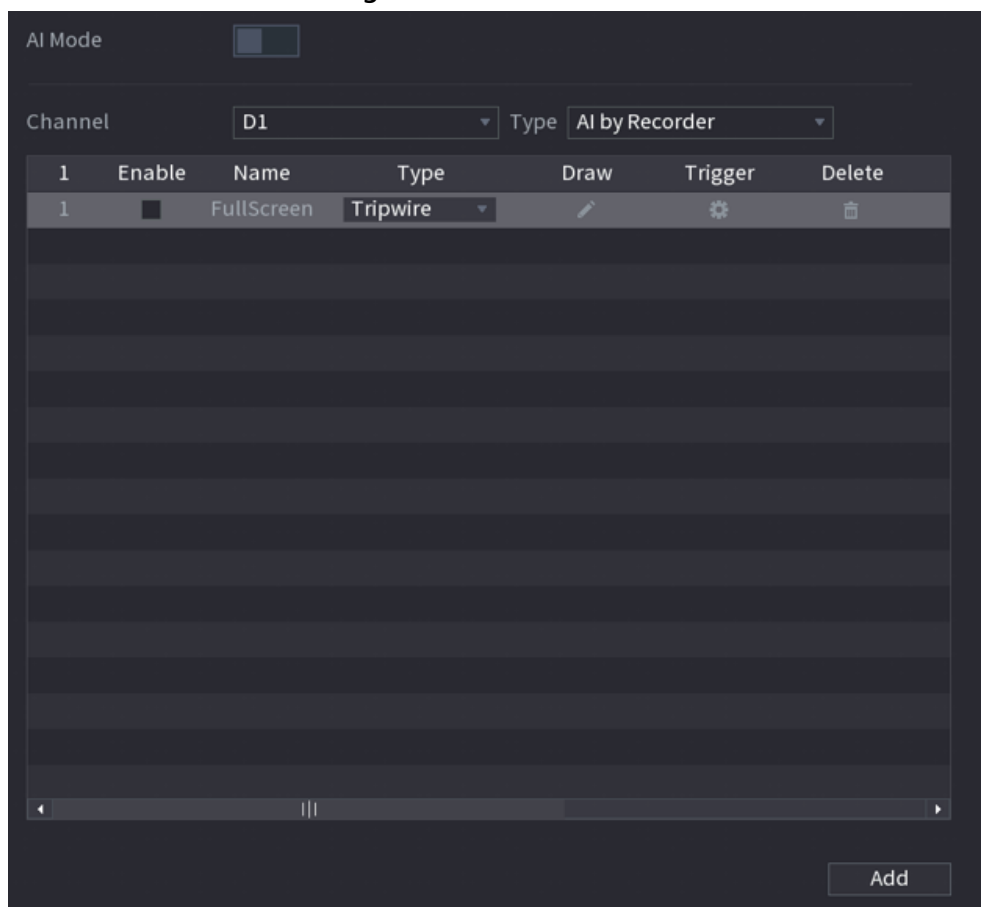

**Step 2** Select channel and Analytics+ type.

**Step 3** Click Add to add a rule.

**Step 4** On the Type list, select Tripwire.

**Step 5** Draw the detection rule.

- 1) Click  to draw a straight line or a curve on the security video image.  
Right-click the image to stop drawing.



Figure 5-107 Tripwire (Analytics+ by camera)

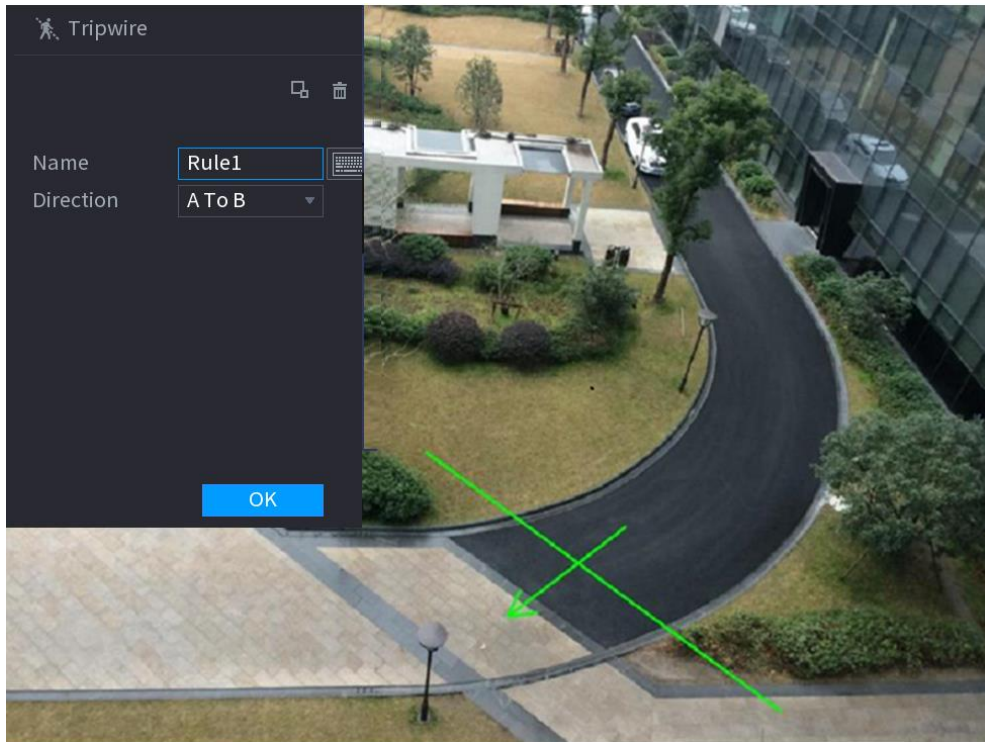
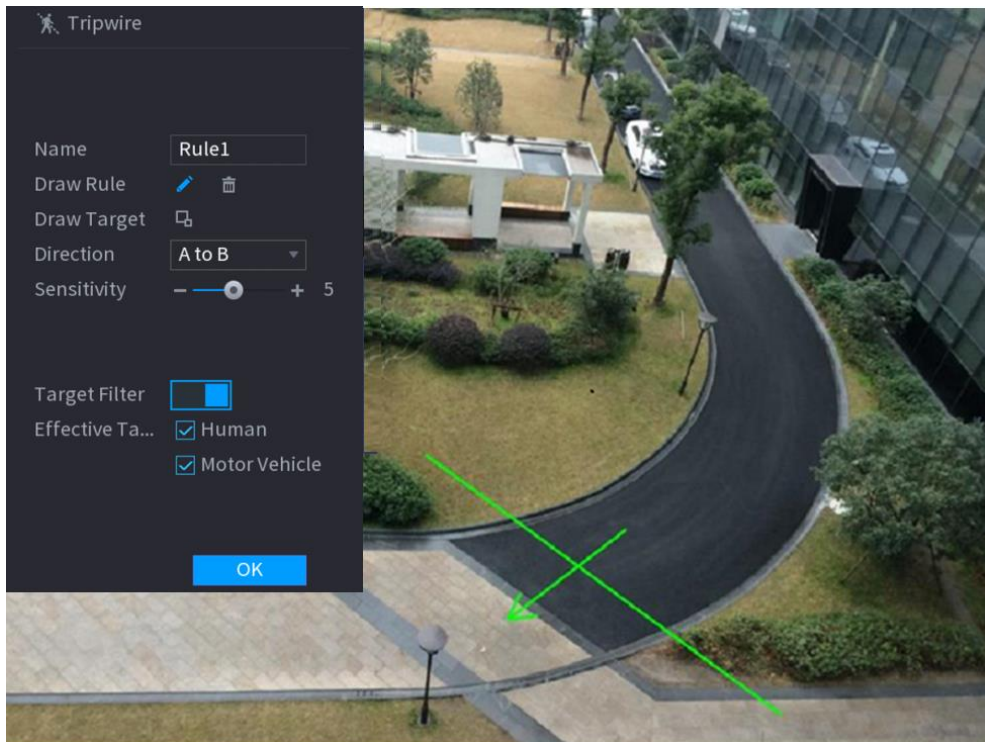

Figure 5-108 Tripwire (Analytics+ by recorder)



2) Click  to draw the minimum size or maximum size to filter the target.

The system triggers an alarm only when the size of detected target is between the maximum size and the minimum size.

3) Configure the parameters.

Table 5-28 Tripwire parameters

Parameter	Description
Name	Customize the rule name.
Direction	Set the tripwire direction, including A→B, B→A and A↔B.
Target Filter	Click  and then select effective target. With Human and Motor Vehicle selected by default, the system automatically identifies the person and motor vehicle appeared within the monitoring range.

4) Click OK.

**Step 6** Configure alarm schedule and linkage.

Figure 5-109 Schedule and alarm linkage

1) Click .

2) Click Setting next to Schedule to configure the alarm period.

The system performs linkage actions only for alarms during the arming period.

- On the time line, drag to set the period.
- You can also click  to set the period.

3) Configure alarm linkage. For details, see Table 5-43.

4) Click Apply.

**Step 7** Select the Enable checkbox and then click Apply.

### 5.9.6.2.2 Intrusion

## Background Information

When the detection target passes the edge of the monitoring area, and enters, leaves or traverses the monitoring area, the system performs an alarm linkage action.

## Procedure

**Step 1** Select Main Menu > Analytics+ > Parameters > IVS.

Figure 5-110 IVS

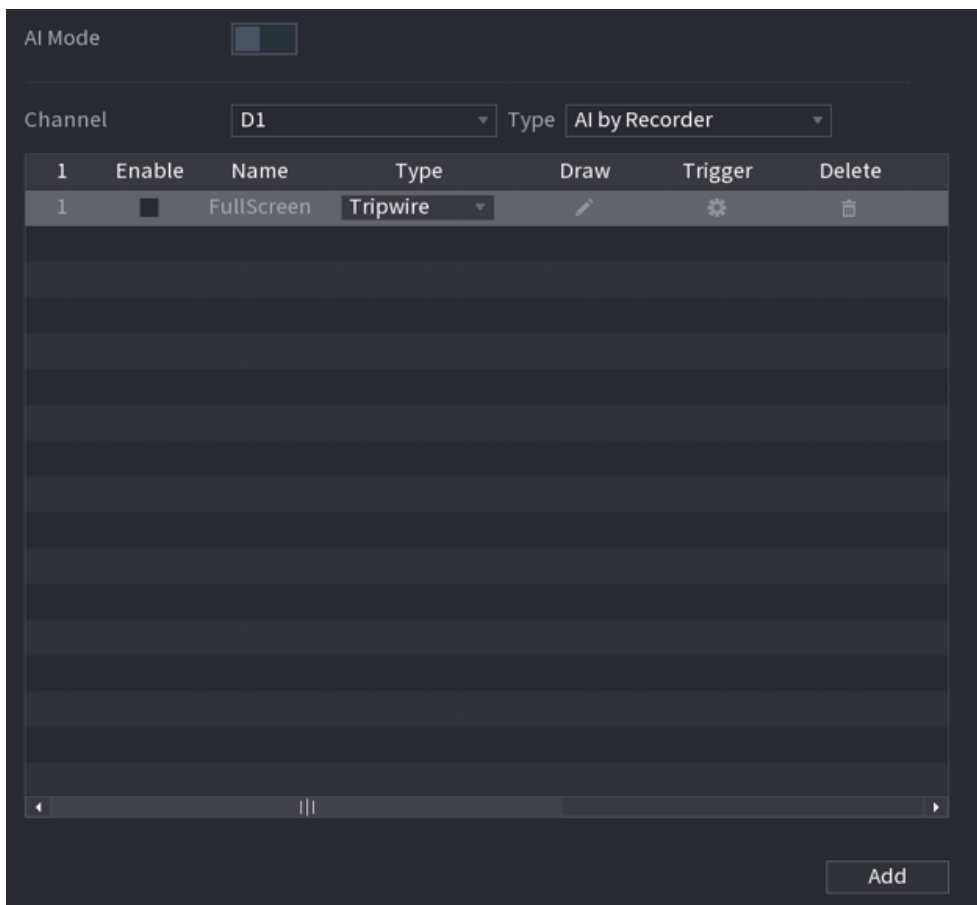

**Step 2** Select channel and Analytics+ type.

**Step 3** Click Add to add a rule.

**Step 4** On the Type list, select Intrusion.

**Step 5** Draw the detection rule.

- 1) Click  to draw the rule on the security video image. Right-click the image to stop drawing.

Figure 5-111 Intrusion (Analytics+ by camera)

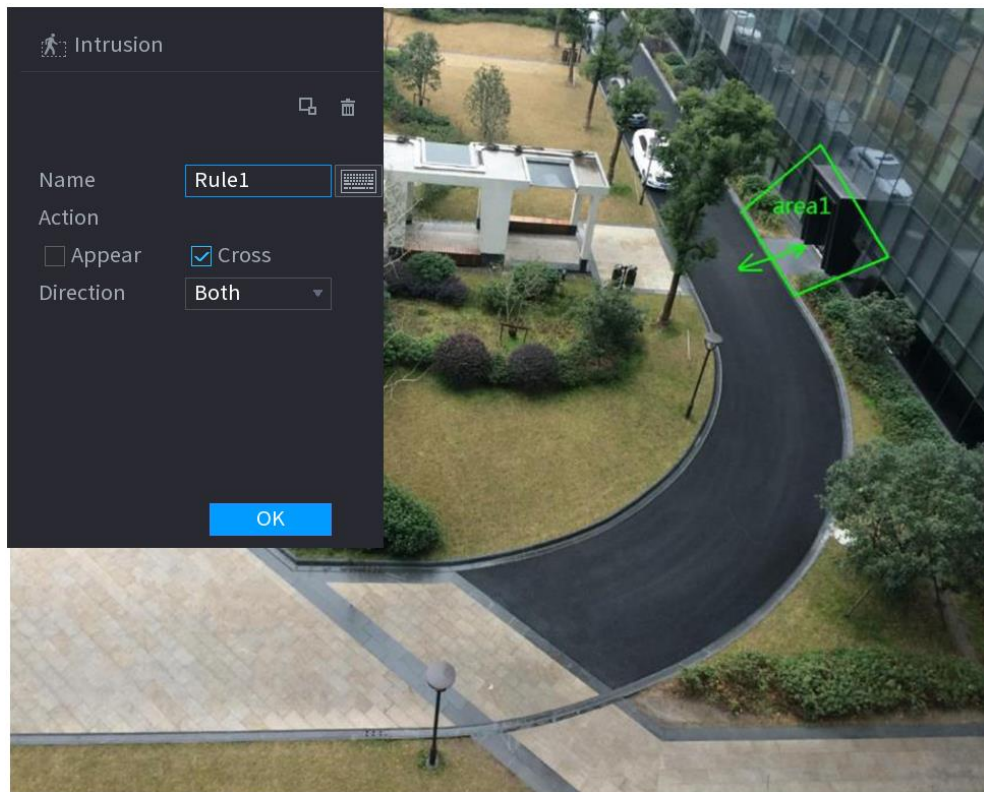
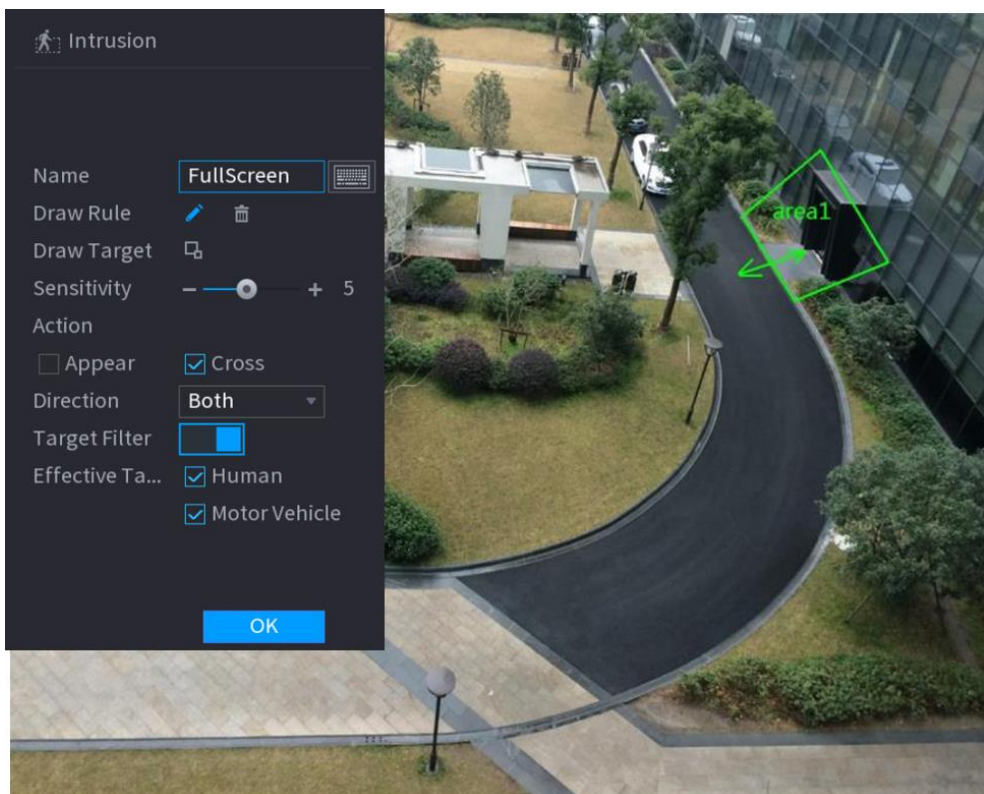

Figure 5-112 Intrusion (Analytics+ by recorder)





- 2) Click  to draw the minimum size or maximum size to filter the target. The system triggers an alarm only when the size of detected target is between the maximum size and the minimum size.
- 3) Configure the parameters.

Table 5-29 Intrusion parameters

Parameter	Description
Name	Customize the rule name.
Action	Set the intrusion action, including appear and crossing area.
Direction	Set the direction to cross the area, including enter, exit and both.
Target Filter	Click  and then select effective target. With Human and Motor Vehicle selected by default, the system automatically identifies the person and motor vehicle appeared within the monitoring range.

4) Click OK.

**Step 6** Configure alarm schedule and linkage.

Figure 5-113 Schedule and alarm linkage

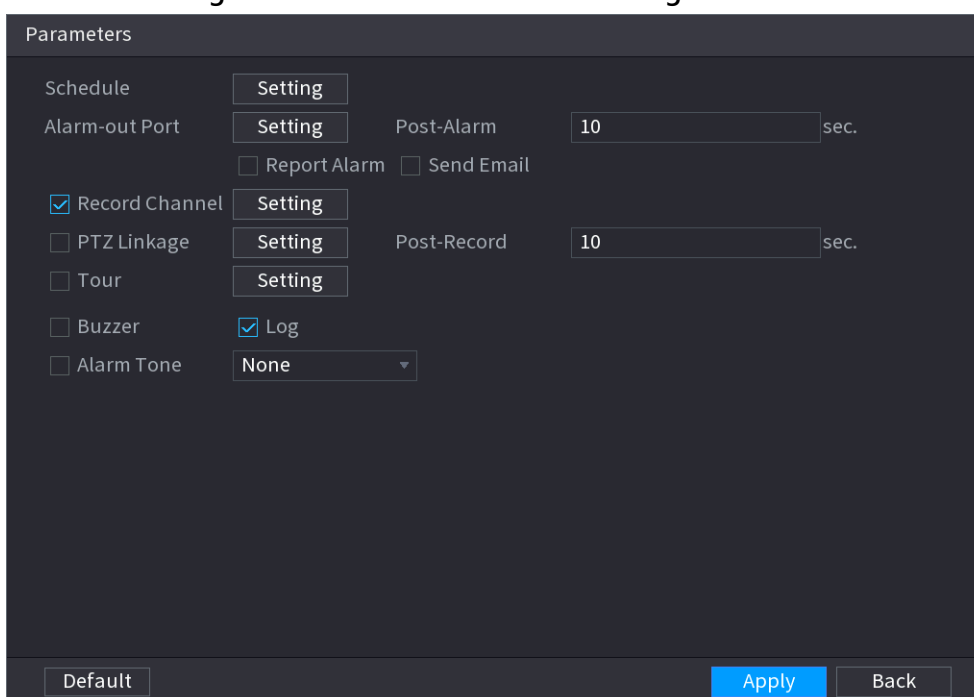

1) Click .

2) Click Setting next to Schedule to configure the alarm period.

The system performs linkage actions only for alarms during the arming period.

- On the time line, drag to set the period.
- You can also click  to set the period.

3) Configure alarm linkage. For details, see Table 5-43.

4) Click Apply.

**Step 7** Select Enable checkbox and then click Apply.

### 5.9.6.2.3 Abandoned Object Detection

## Background Information

The system generates an alarm when there is an abandoned object in the specified zone.



## Procedure

**Step 1** Select Main Menu > Analytics+ > Parameters > IVS.

Figure 5-114 IVS

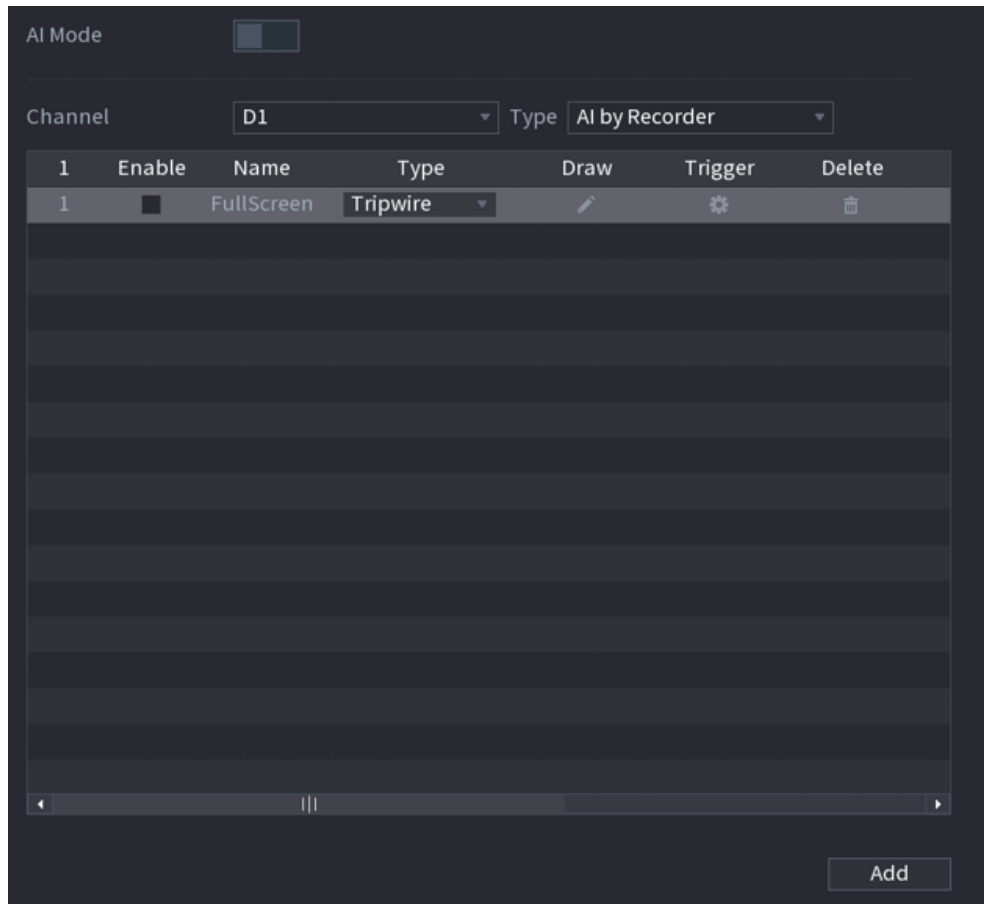

**Step 2** Select channel and Analytics+ type.

**Step 3** Click Add to add a rule.

**Step 4** On the Type list, select Abandoned Object.

**Step 5** Draw the detection rule.

- 1) Click to draw a rectangle on the security video image. Right-click the image to stop drawing.

Figure 5-115 Abandoned object rule

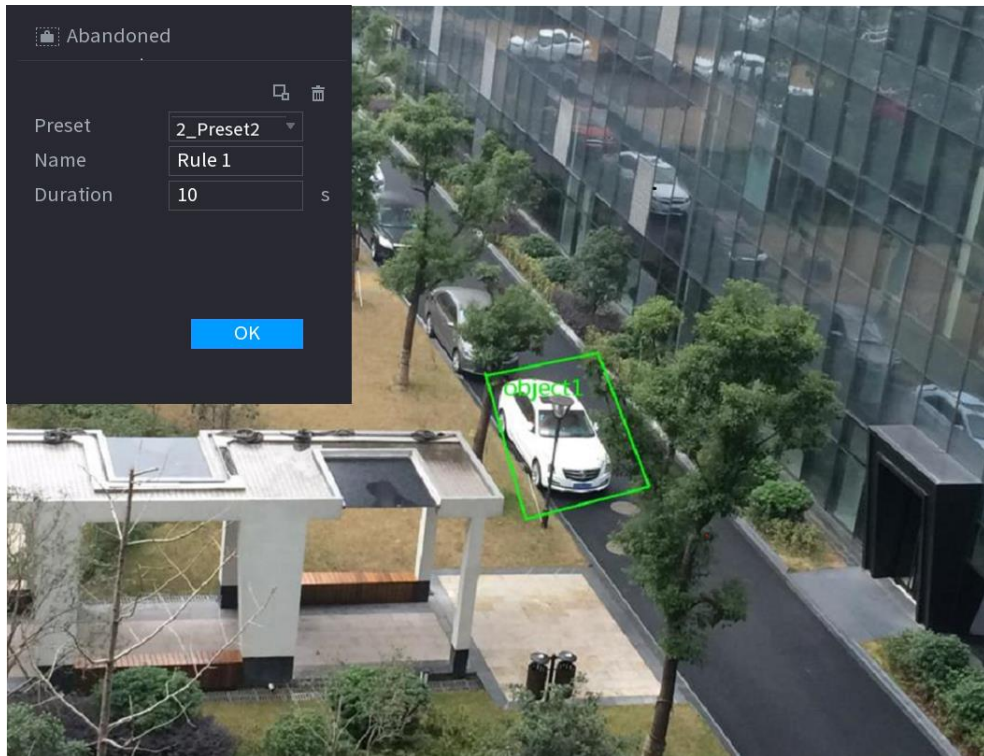

- 2) Click  to draw the minimum size or maximum size to filter the target. The system triggers an alarm only when the size of detected target is between the maximum size and the minimum size.
- 3) Configure parameters.

Table 5-30 Parameters of abandoned object detection

Parameter	Description
Preset	Select a preset you want to use IVS.
Name	Customize the rule name.
Duration	The system generates an alarm once the object is in the zone for the defined period.



- 4) Click OK.

**Step 6** Configure alarm schedule and linkage.

Figure 5-116 Schedule and alarm linkage

Parameters

Schedule	<input type="button" value="Setting"/>		
Alarm-out Port	<input type="button" value="Setting"/>	Post-Alarm	<input type="text" value="10"/> sec.
		<input type="checkbox"/> Report Alarm	<input type="checkbox"/> Send Email
<input checked="" type="checkbox"/> Record Channel	<input type="button" value="Setting"/>		
<input type="checkbox"/> PTZ Linkage	<input type="button" value="Setting"/>	Post-Record	<input type="text" value="10"/> sec.
<input type="checkbox"/> Tour	<input type="button" value="Setting"/>		
<input type="checkbox"/> Buzzer	<input checked="" type="checkbox"/> Log		
<input type="checkbox"/> Alarm Tone	<input type="text" value="None"/>		

- 1) Click .
- 2) Click Setting next to Schedule to configure the alarm period.  
The system performs linkage actions only for alarms during the arming period.
  - On the time line, drag to set the period.
  - You can also click  to set the period.
- 3) Configure alarm linkage. For details, see Table 5-43.
- 4) Click Apply.

**Step 7** Select Enable checkbox and then click Apply.

#### 5.9.6.2.4 Fast Moving

### Background Information

You can detect the fast moving object in the specified zone.

### Procedure

**Step 1** Select Main Menu > Analytics+ > Parameters > IVS.



Figure 5-117 IVS

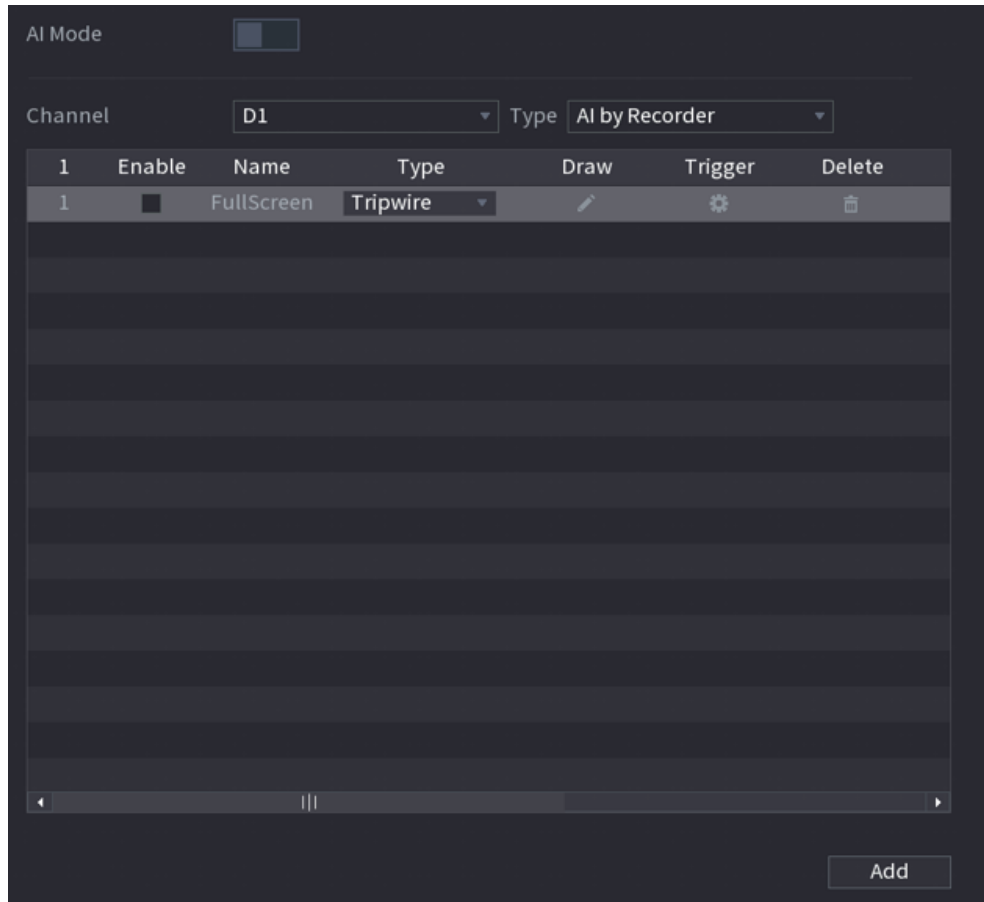

**Step 2** Select channel and Analytics+ type.

**Step 3** Click Add to add a rule.

**Step 4** On the Type list, select Fast Moving.

**Step 5** Draw the detection rule.

- 1) Click  to draw a rectangle on the security video image. Right-click the image to stop drawing.

Figure 5-118 Fast moving



- 2) Click  to draw the minimum size or maximum size to filter the target. The system triggers an alarm only when the size of detected target is between the maximum size and the minimum size.
- 3) Configure parameters.

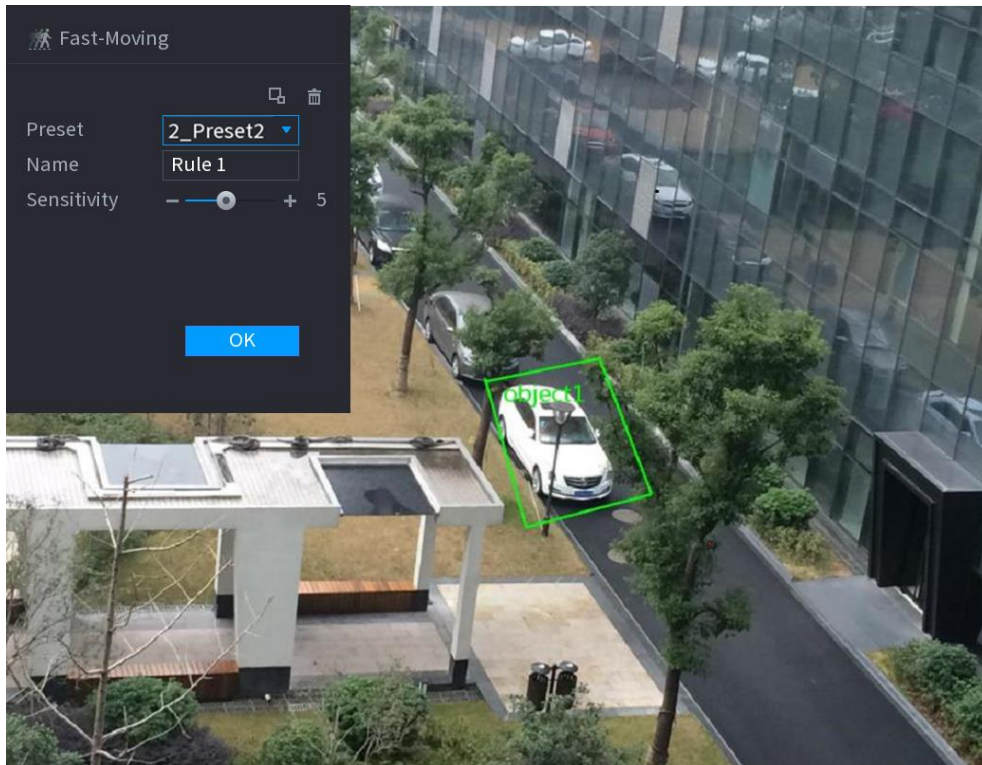

Table 5-31 Fast moving parameters

Parameter	Description
Preset	Select a preset you want to use IVS.
Name	Customize the rule name.
Sensitivity	You can set alarm sensitivity. The higher the value, the easier to detect a fast moving object but meanwhile the higher false alarm rate.

- 4) Click OK.

**Step 6** Configure alarm schedule and linkage.

Figure 5-119 Schedule and alarm linkage

- 1) Click .
- 2) Click Setting next to Schedule to configure the alarm period.  
The system performs linkage actions only for alarms during the arming period.
  - On the time line, drag to set the period.
  - You can also click  to set the period.
- 3) Configure alarm linkage. For details, see Table 5-43.
- 4) Click Apply.

**Step 7** Select Enable checkbox and then click Apply.

### 5.9.6.2.5 Parking

## Background Information

When the detection target stays in the monitoring area longer than the set duration, the system performs alarm linkage action.

## Procedure

**Step 1** Select Main Menu > Analytics+ > Parameters > IVS.

Figure 5-120 IVS

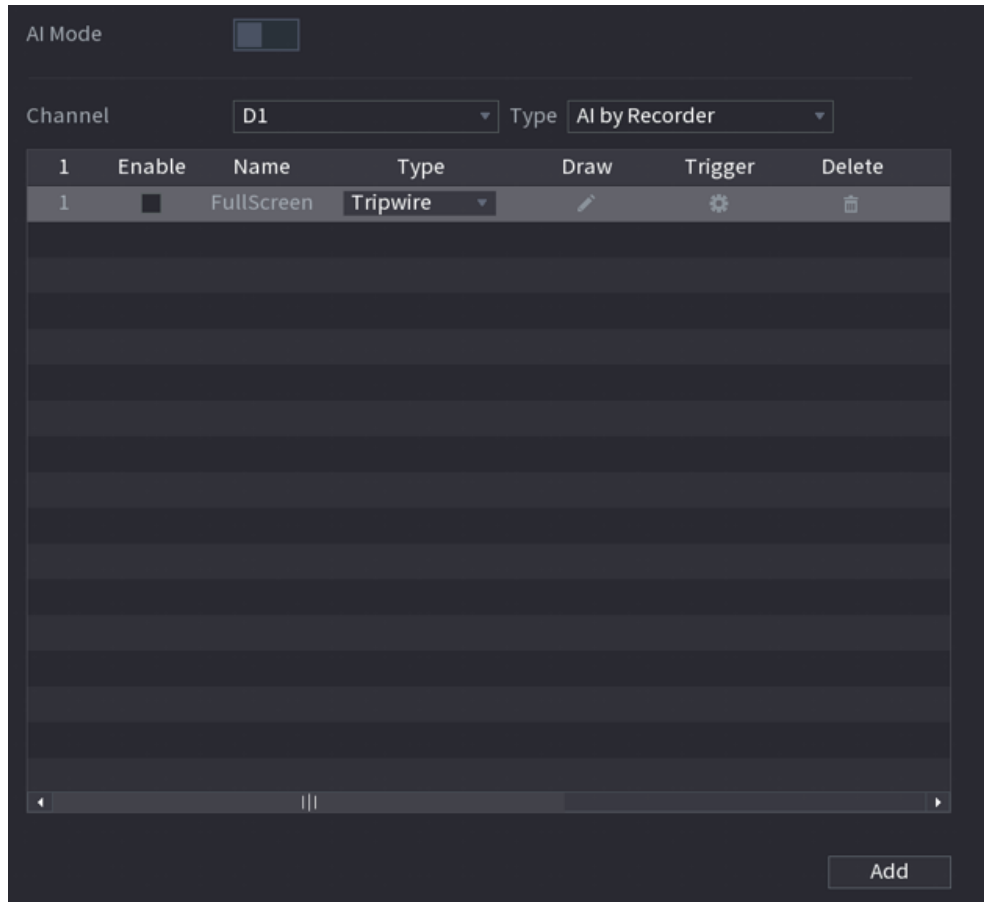

**Step 2** Select channel and Analytics+ type.

**Step 3** Click Add to add a rule.

**Step 4** On the Type list, select Parking.

**Step 5** Draw the detection rule.

- 1) Click  to draw a rectangle on the security video image. Right-click the image to stop drawing.

Figure 5-121 Parking



- 2) Click  to draw the minimum size or maximum size to filter the target. The system triggers an alarm only when the size of detected target is between the maximum size and the minimum size.
- 3) Configure parameters.

Table 5-32 Parking parameters

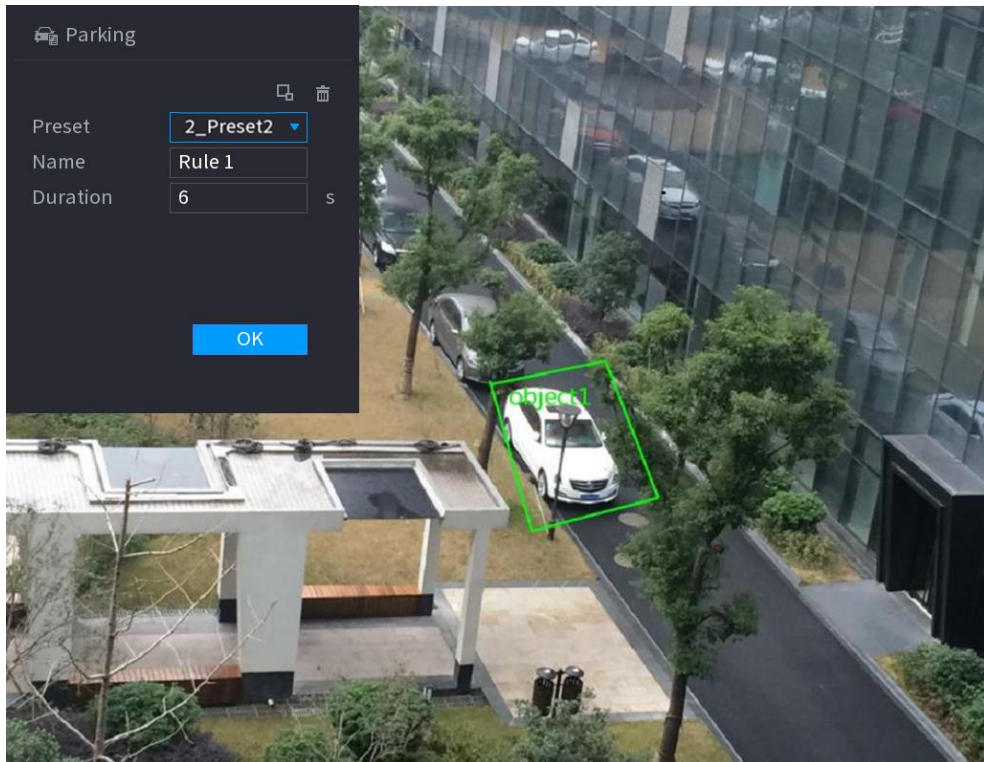
Parameter	Description
Preset	Set the preset point for IVS detection.
Name	Customize the rule name.
Duration	Set how long the object stays until the alarm is triggered.

- 4) Click OK.

**Step 6** Configure alarm schedule and linkage.

Figure 5-122 Schedule and alarm linkage

Parameters

Schedule	<input type="button" value="Setting"/>		
Alarm-out Port	<input type="button" value="Setting"/>	Post-Alarm	<input type="text" value="10"/> sec.
		<input type="checkbox"/> Report Alarm	<input type="checkbox"/> Send Email
<input checked="" type="checkbox"/> Record Channel	<input type="button" value="Setting"/>		
<input type="checkbox"/> PTZ Linkage	<input type="button" value="Setting"/>	Post-Record	<input type="text" value="10"/> sec.
<input type="checkbox"/> Tour	<input type="button" value="Setting"/>		
<input type="checkbox"/> Buzzer	<input checked="" type="checkbox"/> Log		
<input type="checkbox"/> Alarm Tone	<input type="text" value="None"/>		

- 1) Click .
- 2) Click Setting next to Schedule to configure the alarm period.  
The system performs linkage actions only for alarms during the arming period.
  - On the time line, drag to set the period.
  - You can also click to set the period.
- 3) Configure alarm linkage. For details, see Table 5-43.
- 4) Click Apply.

**Step 7** Select Enable checkbox and then click Apply.

### 5.9.6.2.6 Crowd Gathering

#### Background Information

The system generates an alarm once people are gathering in the specified zone longer than the defined duration.

#### Procedure

**Step 1** Select Main Menu > Analytics+ > Parameters > IVS.

Figure 5-123 IVS

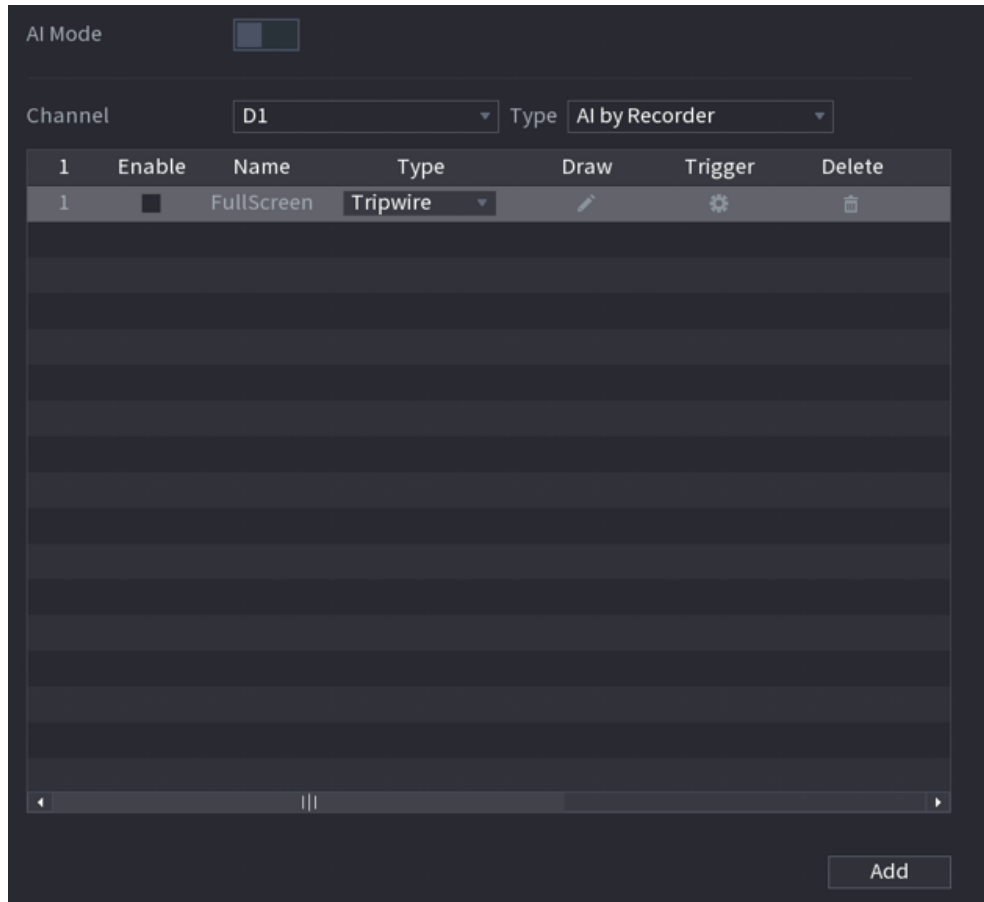

**Step 2** Select channel and Analytics+ type.

**Step 3** Click Add to add a rule.

**Step 4** On the Type list, select Crowd Gathering Estimation.

**Step 5** Draw the detection rule.

- 1) Click  to draw a rectangle on the security video image. Right-click the image to stop drawing.

Figure 5-124 Crowd gathering



- 2) Click  to draw the minimum size or maximum size to filter the target. The system triggers an alarm only when the size of detected target is between the maximum size and the minimum size.
- 3) Set parameters.

Table 5-33 Crowd gathering parameters

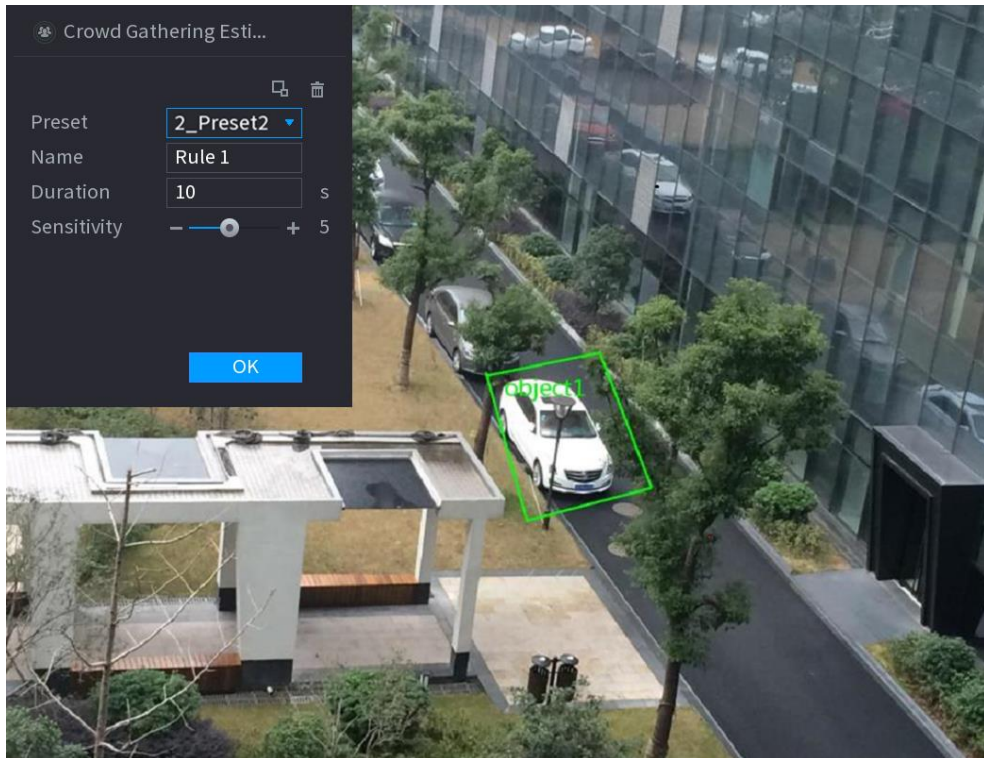
Parameter	Description
Preset	Select a preset you want to use IVS.
Name	Customize the rule name.
Duration	Set how long the object stays until the alarm is triggered.
Sensitivity	You can set alarm sensitivity. The higher the value, the easier to detect crowd gathering but meanwhile the higher false alarm rate.

- 4) Click OK.



**Step 6** Configure alarm schedule and linkage.



Figure 5-125 Schedule and alarm linkage

Parameters

Schedule	<input type="button" value="Setting"/>		
Alarm-out Port	<input type="button" value="Setting"/>	Post-Alarm	<input type="text" value="10"/> sec.
		<input type="checkbox"/> Report Alarm	<input type="checkbox"/> Send Email
<input checked="" type="checkbox"/> Record Channel	<input type="button" value="Setting"/>		
<input type="checkbox"/> PTZ Linkage	<input type="button" value="Setting"/>	Post-Record	<input type="text" value="10"/> sec.
<input type="checkbox"/> Tour	<input type="button" value="Setting"/>		
<input type="checkbox"/> Buzzer	<input checked="" type="checkbox"/> Log		
<input type="checkbox"/> Alarm Tone	<input type="text" value="None"/>		

- 1) Click .
- 2) Click Setting next to Schedule to configure the alarm period.  
The system performs linkage actions only for alarms during the arming period.
  - On the time line, drag to set the period.
  - You can also click  to set the period.
- 3) Configure alarm linkage. For details, see Table 5-43.
- 4) Click Apply.

**Step 7** Select Enable checkbox and then click Apply.

### 5.9.6.2.7 Missing Object Detection

#### Background Information

The system generates an alarm when there is missing object in the specified zone.

#### Procedure

**Step 1** Select Main Menu > Analytics+ > Parameters > IVS.

Figure 5-126 IVS

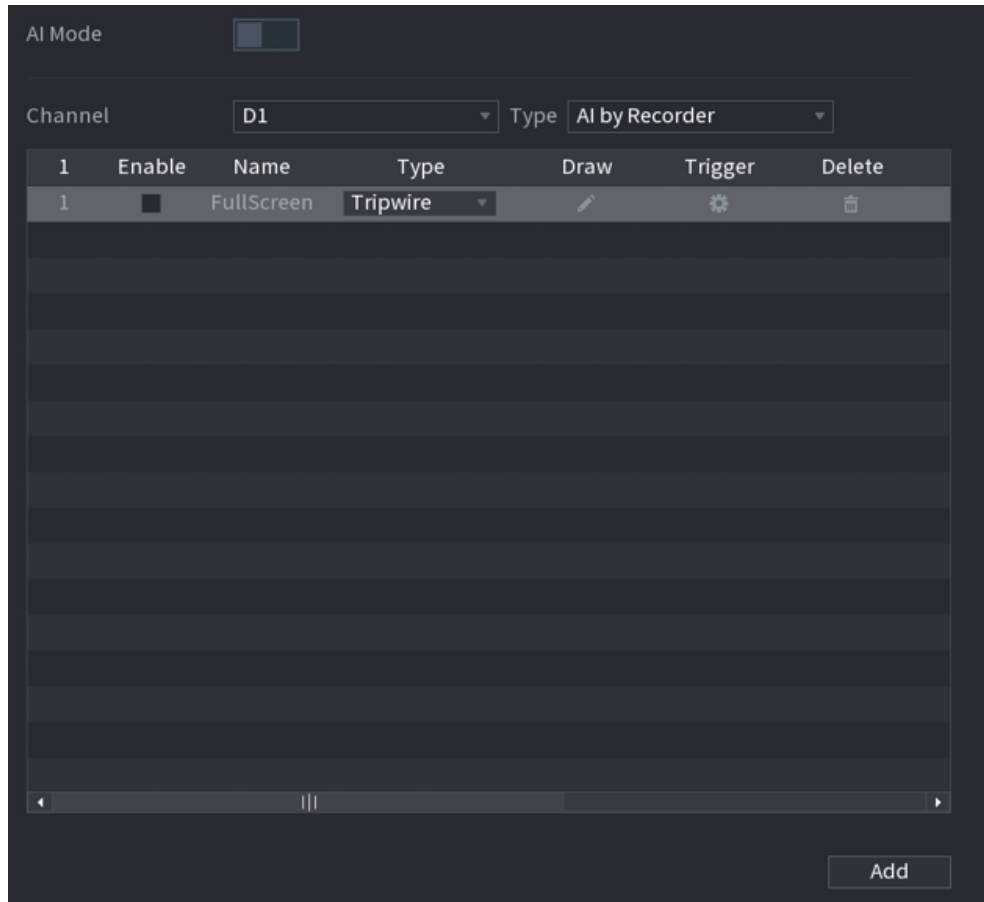

**Step 2** Select channel and Analytics+ type.

**Step 3** Click Add to add a rule.

**Step 4** On the Type list, select Missing.

**Step 5** Draw the detection rule.

- 1) Click  to draw a rectangle on the security video image. Right-click the image to stop drawing.

Figure 5-127 Missing object



- 2) Click  to draw the minimum size or maximum size to filter the target.  
The system triggers an alarm only when the size of detected target is between the maximum size and the minimum size.
- 3) Configure parameters.

Table 5-34 Parameters of missing object detection

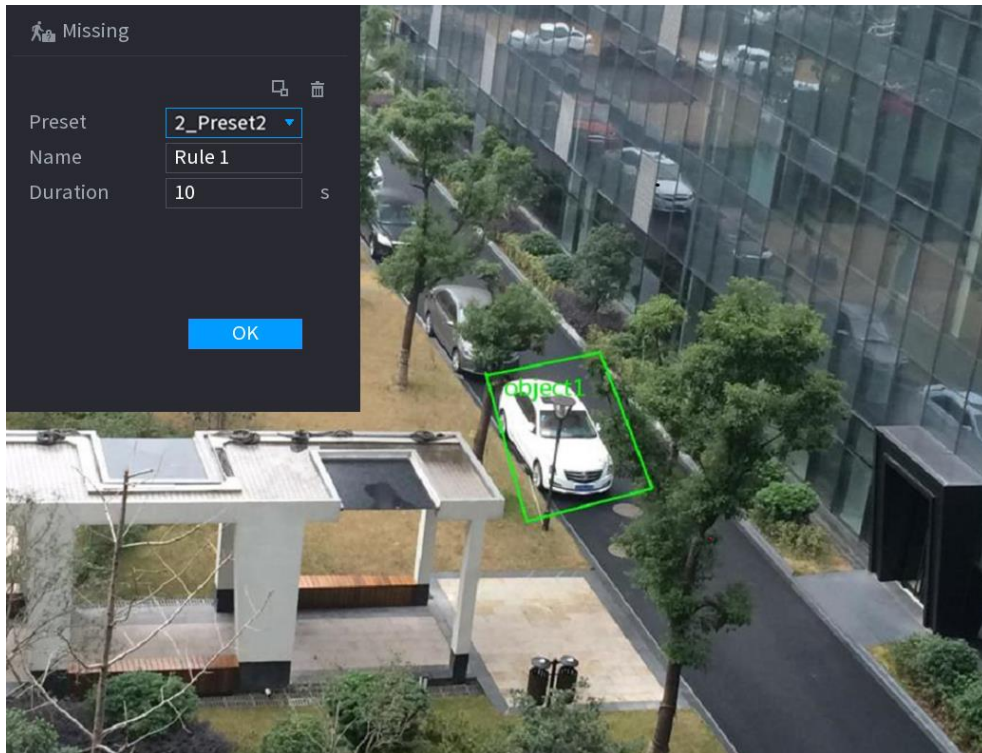
Parameter	Description
Preset	Set the preset point for IVS detection according to the actual needs.
Name	Customize the rule name.
Duration	Set how long the object stays until the alarm is triggered.

- 4) Click OK.

**Step 6** Configure alarm schedule and linkage.

Figure 5-128 Schedule and alarm linkage

Parameters

Schedule	<input type="button" value="Setting"/>		
Alarm-out Port	<input type="button" value="Setting"/>	Post-Alarm	<input type="text" value="10"/> sec.
		<input type="checkbox"/> Report Alarm	<input type="checkbox"/> Send Email
<input checked="" type="checkbox"/> Record Channel	<input type="button" value="Setting"/>		
<input type="checkbox"/> PTZ Linkage	<input type="button" value="Setting"/>	Post-Record	<input type="text" value="10"/> sec.
<input type="checkbox"/> Tour	<input type="button" value="Setting"/>		
<input type="checkbox"/> Buzzer	<input checked="" type="checkbox"/> Log		
<input type="checkbox"/> Alarm Tone	<input type="text" value="None"/>		

- 1) Click .
- 2) Click Setting next to Schedule to configure the alarm period.  
 The system performs linkage actions only for alarms during the arming period.
  - On the time line, drag to set the period.
  - You can also click to set the period.
- 3) Configure alarm linkage. For details, see Table 5-43.
- 4) Click Apply.

**Step 7** Select Enable checkbox and then click Apply.

### 5.9.6.2.8 Loitering Detection

#### Background Information

The system generates an alarm once the object is staying in the specified zone longer than the defined duration.

#### Procedure

**Step 1** Select Main Menu > Analytics+ > Parameters > IVS.

Figure 5-129 IVS

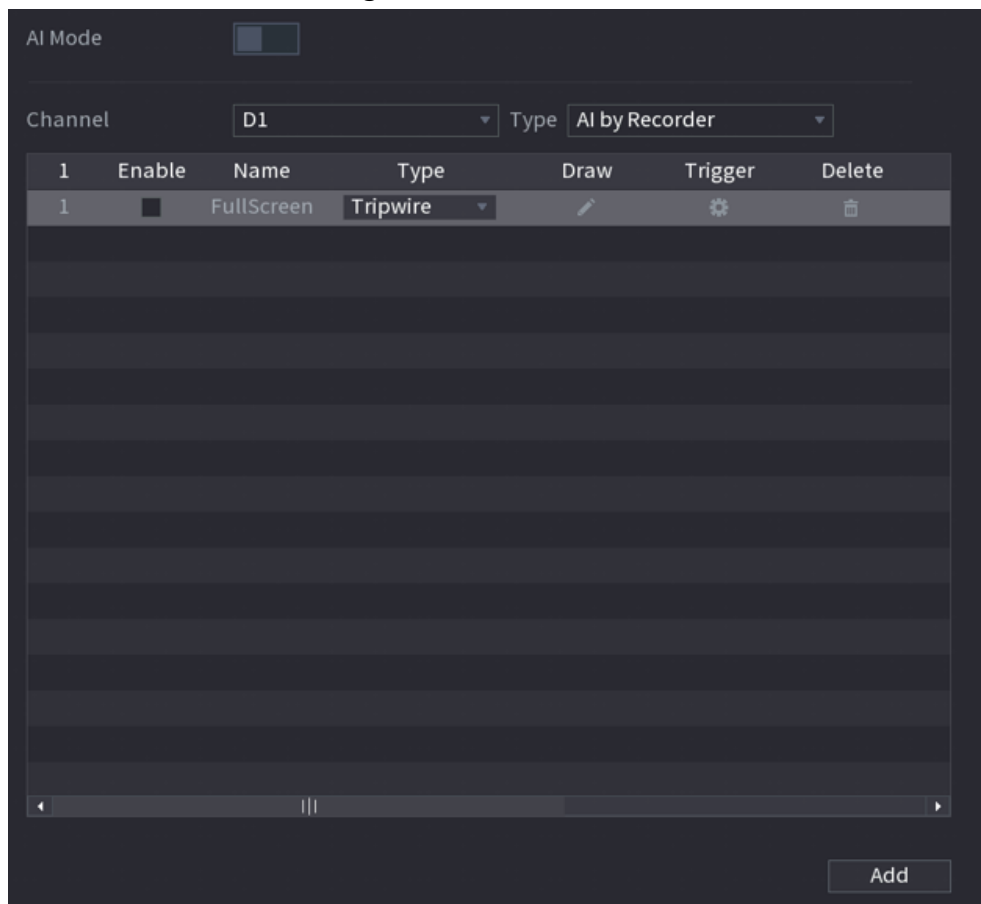

**Step 2** Select channel and Analytics+ type.

**Step 3** Click Add to add a rule.

**Step 4** On the Type list, select Loitering Detection.

**Step 5** Draw the detection rule.

- 1) Click  to draw a rectangle on the security video image. Right-click the image to stop drawing.

Figure 5-130 Loitering detection



- 2) Click  to draw the minimum size or maximum size to filter the target. The system triggers an alarm only when the size of detected target is between the maximum size and the minimum size.
- 3) Configure parameters.

Table 5-35 Loitering detection parameters

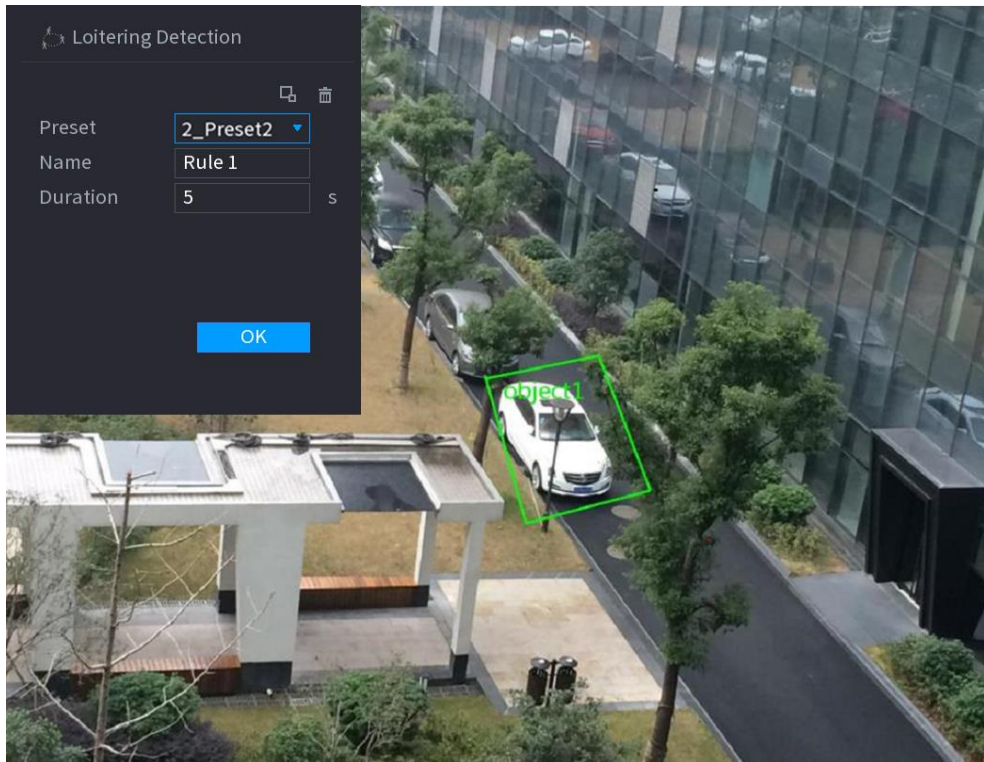
Parameter	Description
Preset	Set the preset point for IVS detection.
Name	Customize the rule name.
Duration	Set how long the object stays until the alarm is triggered.



- 4) Click OK.

**Step 6** Configure alarm schedule and linkage.

Figure 5-131 Schedule and alarm linkage

Parameters

Schedule	<input type="button" value="Setting"/>		
Alarm-out Port	<input type="button" value="Setting"/>	Post-Alarm	<input type="text" value="10"/> sec.
		<input type="checkbox"/> Report Alarm	<input type="checkbox"/> Send Email
<input checked="" type="checkbox"/> Record Channel	<input type="button" value="Setting"/>		
<input type="checkbox"/> PTZ Linkage	<input type="button" value="Setting"/>	Post-Record	<input type="text" value="10"/> sec.
<input type="checkbox"/> Tour	<input type="button" value="Setting"/>		
<input type="checkbox"/> Buzzer	<input checked="" type="checkbox"/> Log		
<input type="checkbox"/> Alarm Tone	<input type="text" value="None"/>		

- 1) Click .
- 2) Click Setting next to Schedule to configure the alarm period.  
The system performs linkage actions only for alarms during the arming period.
  - On the time line, drag to set the period.
  - You can also click  to set the period.
- 3) Configure alarm linkage. For details, see Table 5-43.
- 4) Click Apply.

**Step 7** Select Enable checkbox and then click Apply.

### 5.9.6.3 Analytics+ Search (IVS)

#### Background Information

You can search for IVS detection results.

#### Procedure



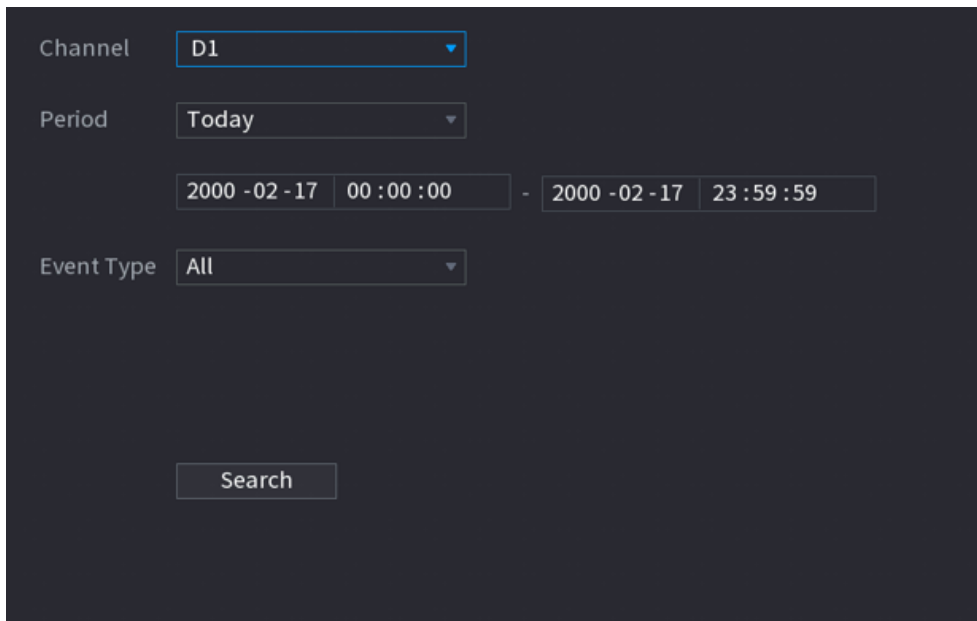

**Step 1** Select Main Menu > Analytics+ > Analytics+ Search > IVS.

Figure 5-132 IVS search



**Step 2** Select a channel, start time, end time, event type, and then click Search.  
The search results are displayed.

## Related Operations

- Play back video.  
Click an image, and then click  to play back the related video.  
During playback, you can:
  - ◇ Click  to pause.
  - ◇ Click  to stop.
  - ◇ Click  to display Analytics+ rule. The icon changes to .
- Add tags.  
Select one or more images, and then click Add Tag.
- Lock.  
Select one or more images, and then click Lock. The locked files will not be overwritten.
- Export.  
Select one or more images, and then click Export to export selected search results in excel.
- Back up.  
Select one or more images, click Backup, select the storage path and file type, and then click Start to export files to external storage device.

## 5.9.7 Stereo Analysis

By drawing and setting the rules of stereo behavior analysis, the system will perform alarm linkage actions when the video matches the detection rule. Types of events include: people approach detection, fall detection, violence detection, people No. exception detection and



people stay detection.



- This function requires access to a camera that supports stereo behavior analysis.
- Stereo analysis and IVS are mutually exclusive and cannot be enabled at the same time.

## 5.9.7.1 Enabling Smart Plan

To use Analytics+ by camera, you need to enable the smart plan first. For details, see "5.9.2 Smart Plan".

## 5.9.7.2 Configuring Stereo Analysis

### 5.9.7.2.1 People Approach Detection

When two people stay in the same detection area longer than the defined duration or when the distance between two people is larger or smaller than the defined threshold, an alarm will be triggered.

### Procedure

**Step 1** Select Main Menu > Analytics+ > Parameters > Stereo Analysis.

**Step 2** Select a channel and then click Add.

**Step 3** Select Enable and then set Type to People Approach Detection.

**Step 4** Draw detection rule.

- 1) Click  and then draw a detection area on the video image. Right-click the image to stop drawing.
- 2) Configure parameters.

Table 5-36 Parameters of people approach detection

Parameter	Description
Name	Customize the rule name.
Sensitivity	Set alarm sensitivity.
Duration	Set how long two people stay in the same detection area until an alarm is triggered.
Repeat Alarm Time	Set repeat alarm time. If the alarm-triggering event continues, an alarm will be triggered again when repeat alarm time passed.
Interval Threshold	When the distance between people in the area is greater than or less than the defined threshold, an alarm will be triggered.

- 3) Click OK.

**Step 5** Configure alarm schedule and linkage.

Figure 5-133 Schedule and alarm linkage

Parameters

Schedule	<input type="button" value="Setting"/>		
Alarm-out Port	<input type="button" value="Setting"/>	Post-Alarm	<input type="text" value="10"/> sec.
		<input type="checkbox"/> Report Alarm	<input type="checkbox"/> Send Email
<input checked="" type="checkbox"/> Record Channel	<input type="button" value="Setting"/>		
<input type="checkbox"/> PTZ Linkage	<input type="button" value="Setting"/>	Post-Record	<input type="text" value="10"/> sec.
<input type="checkbox"/> Tour	<input type="button" value="Setting"/>		
<input type="checkbox"/> Buzzer	<input checked="" type="checkbox"/> Log		
<input type="checkbox"/> Alarm Tone	<input type="text" value="None"/>		

- 1) Click .
- 2) Click Setting next to Schedule to configure the alarm period.  
The system performs linkage actions only for alarms during the arming period.
  - On the time line, drag to set the period.
  - You can also click to set the period.
- 3) Configure alarm linkage. For details, see Table 5-43.
- 4) Click Apply.

**Step 6** Click Apply.

### 5.9.7.2.2 Fall Detection

When someone falls from a height in the detection area and the duration of the action is greater than the defined threshold, an alarm will be triggered.

#### Procedure

**Step 1** Select Main Menu > Analytics+ > Parameters > Stereo Analysis.

**Step 2** Select a channel and then click Add.

**Step 3** Select Enable and then set Type to Fall Detection.

**Step 4** Draw detection rule.

- 1) Click , and then draw a detection area on the video image. Right-click the image to stop drawing.
- 2) Configure parameters.

Table 5-37 Parameters of fall detection

Parameter	Description
Name	Customize the rule name.
Sensitivity	Set alarm sensitivity.
Duration	Set the minimum time of triggering an alarm when people fall.
Repeat Alarm Time	Set repeat alarm time. If the alarm-triggering event continues, an alarm will be triggered again when repeat alarm time passed.

3) Click OK.

**Step 5** Configure alarm schedule and linkage.

Figure 5-134 Schedule and alarm linkage

1) Click .

2) Click Setting next to Schedule to configure the alarm period.

The system performs linkage actions only for alarms during the arming period.

- On the time line, drag to set the period.
- You can also click  to set the period.

3) Configure alarm linkage. For details, see Table 5-43.

4) Click Apply.

**Step 6** Click Apply.

### 5.9.7.2.3 Violence Detection

When the target in the detection region has large body movements such as smashing and fighting, an alarm will be triggered.

#### Procedure

**Step 1** Select Main Menu > Analytics+ > Parameters > Stereo Analysis.

**Step 2** Select a channel and then click Add.

**Step 3** Select Enable and then set Type to Violence Detection.

**Step 4** Draw detection rule.

- 1) Click , and then draw a detection area on the video image. Right-click the image to stop drawing.
- 2) Configure parameters.

Table 5-38 Parameters of violence detection

Parameter	Description
Name	Customize the rule name.
Sensitivity	Set alarm sensitivity.

- 3) Click OK.

**Step 5** Configure alarm schedule and linkage.

Figure 5-135 Schedule and alarm linkage

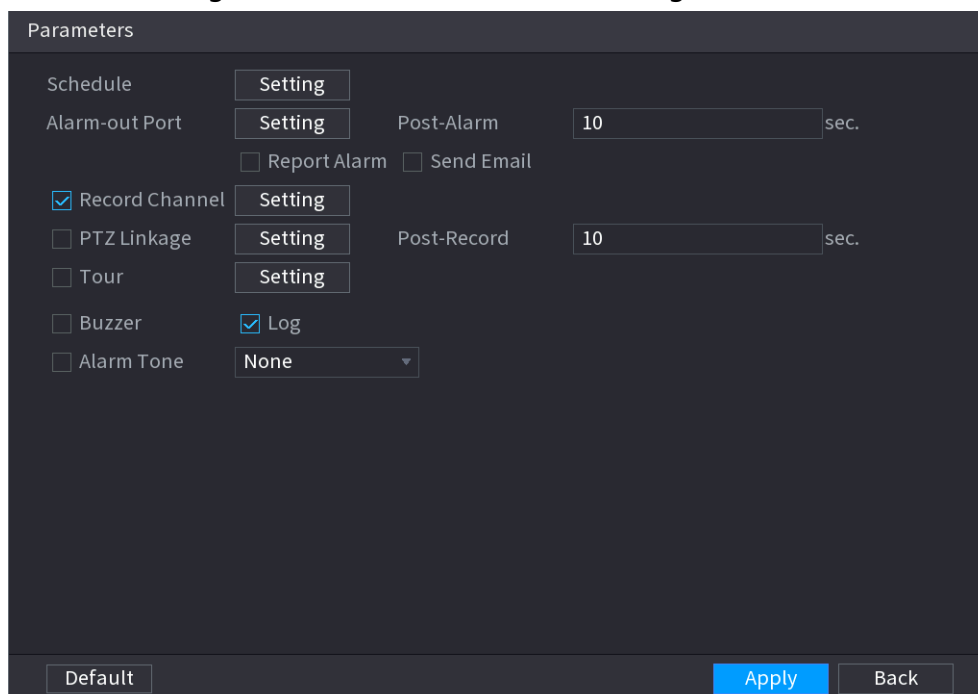

- 1) Click .

- 2) Click Setting next to Schedule to configure the alarm period.

The system performs linkage actions only for alarms during the arming period.

- On the time line, drag to set the period.
- You can also click  to set the period.

- 3) Configure alarm linkage. For details, see Table 5-43.
- 4) Click Apply.

**Step 6** Click Apply.

### 5.9.7.2.4 People No. Exception Detection

When the system detects an abnormal number of people in the same detection area, an alarm will be triggered.

#### Procedure

- Step 1** Select Main Menu > Analytics+ > Parameters > Stereo Analysis.
- Step 2** Select a channel and then click Add.
- Step 3** Select Enable and then set Type to People No. Exception Detection.
- Step 4** Draw detection rule.
  - 1) Click  and then draw a detection area on the video image. Right-click the image to stop drawing.
  - 2) Configure parameters.

Table 5-39 Parameters of people No. exception detection

Parameter	Description
Name	Customize the rule name.
Sensitivity	Set alarm sensitivity.
Duration	Set the minimum time to trigger an alarm after the system detects an abnormal number of people.
Repeat Alarm Time	Set repeat alarm time. If the alarm-triggering event continues, an alarm will be triggered again when repeat alarm time passed.
Alarm People No.	When the number of people in the area is greater than, equal to, or less than the defined threshold, an alarm will be triggered.

- 3) Click OK.

**Step 5** Configure alarm schedule and linkage.

Figure 5-136 Schedule and alarm linkage

Parameters

Schedule	<input type="button" value="Setting"/>		
Alarm-out Port	<input type="button" value="Setting"/>	Post-Alarm	10 sec.
		<input type="checkbox"/> Report Alarm	<input type="checkbox"/> Send Email
<input checked="" type="checkbox"/> Record Channel	<input type="button" value="Setting"/>		
<input type="checkbox"/> PTZ Linkage	<input type="button" value="Setting"/>	Post-Record	10 sec.
<input type="checkbox"/> Tour	<input type="button" value="Setting"/>		
<input type="checkbox"/> Buzzer		<input checked="" type="checkbox"/> Log	
<input type="checkbox"/> Alarm Tone		None	▼

- 1) Click .
- 2) Click Setting next to Schedule to configure the alarm period.  
The system performs linkage actions only for alarms during the arming period.
  - On the time line, drag to set the period.
  - You can also click to set the period.
- 3) Configure alarm linkage. For details, see Table 5-43.
- 4) Click Apply.

**Step 6** Click Apply.

### 5.9.7.2.5 People Stay Detection

When the target stays in the detection area longer than the defined duration, an alarm will be triggered.

#### Procedure

**Step 1** Select Main Menu > Analytics+ > Parameters > Stereo Analysis.

**Step 2** Select a channel and then click Add.

**Step 3** Select Enable and then set Type to People Stay Detection.

**Step 4** Draw detection rule.

- 1) Click , and then draw a detection area on the video image. Right-click the image to stop drawing.
- 2) Configure parameters.

Table 5-40 Parameters of people stay detection

Parameter	Description
Name	Customize the rule name.
Sensitivity	Set alarm sensitivity.
Duration	Set low long people stay in the detection area until an alarm is triggered.
Repeat Alarm Time	Set repeat alarm time. If the alarm-triggering event continues, an alarm will be triggered again when repeat alarm time passed.

3) Click OK.

**Step 5** Configure alarm schedule and linkage.

Figure 5-137 Schedule and alarm linkage

1) Click .

2) Click Setting next to Schedule to configure the alarm period.

The system performs linkage actions only for alarms during the arming period.

- On the time line, drag to set the period.
- You can also click  to set the period.

3) Configure alarm linkage. For details, see Table 5-43.

4) Click Apply.

**Step 6** Click Apply.

### 5.9.7.3 Analytics+ Search (Stereo Analysis)

#### Background Information

You can search for detection results of stereo analysis.

## Procedure



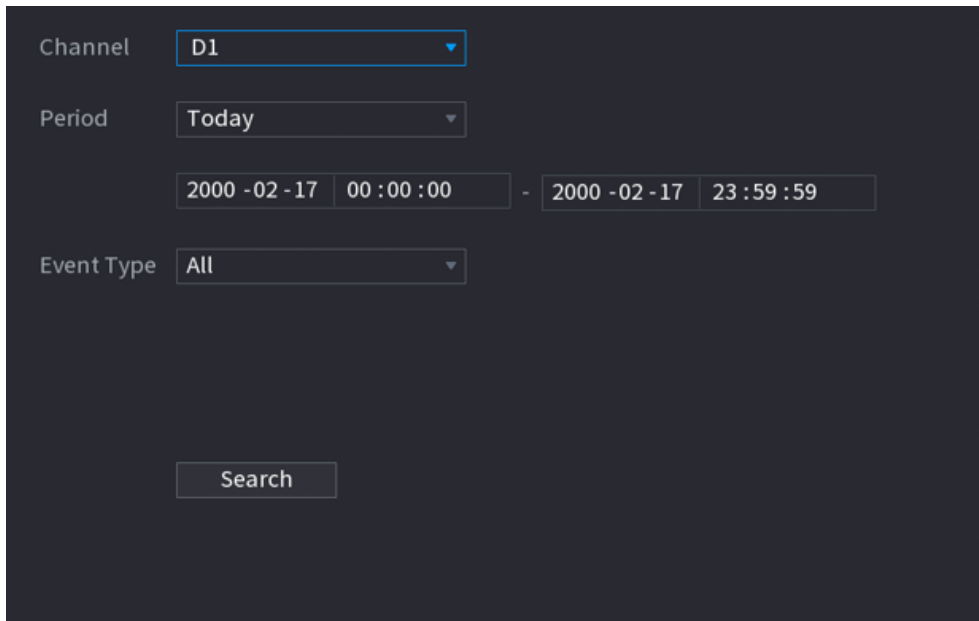

**Step 1** Select Main Menu > Analytics+ > Analytics+ Search > Stereo Analysis.

Figure 5-138 Stereo analysis search



**Step 2** Select a channel, start time, end time, event type, and then click Search.  
The search results are displayed.

## Related Operations

- Play back video.  
Click an image, and then click  to play back the related video.  
During playback, you can:
  - ◇ Click  to pause.
  - ◇ Click  to stop.
  - ◇ Click  to display Analytics+ rule. The icon changes to .
- Add tags.  
Select one or more images, and then click Add Tag.
- Lock.  
Select one or more images, and then click Lock. The locked files will not be overwritten.
- Export.  
Select one or more images, and then click Export to export selected search results in excel.
- Back up.  
Select one or more images, click Backup, select the storage path and file type, and then click Start to export files to external storage device.

## 5.9.8 Video Metadata

The system analyzes real-time video stream to detect the existence of human, motor vehicle,



and non-motor vehicle. Once a target is detected, an alarm is triggered.

### 5.9.8.1 Enabling Smart Plan

To use Analytics+ by camera, you need to enable the smart plan first. For details, see "5.9.2 Smart Plan".

### 5.9.8.2 Configuring Video Metadata

When a metadata alarm is triggered, the system links the corresponding camera to record videos and logs and take snapshots. Other alarm linkage actions are not supported for video metadata.

#### Procedure

Step 1 Select Main Menu > Analytics+ > Parameters > Video Metadata.

Figure 5-139 Video metadata

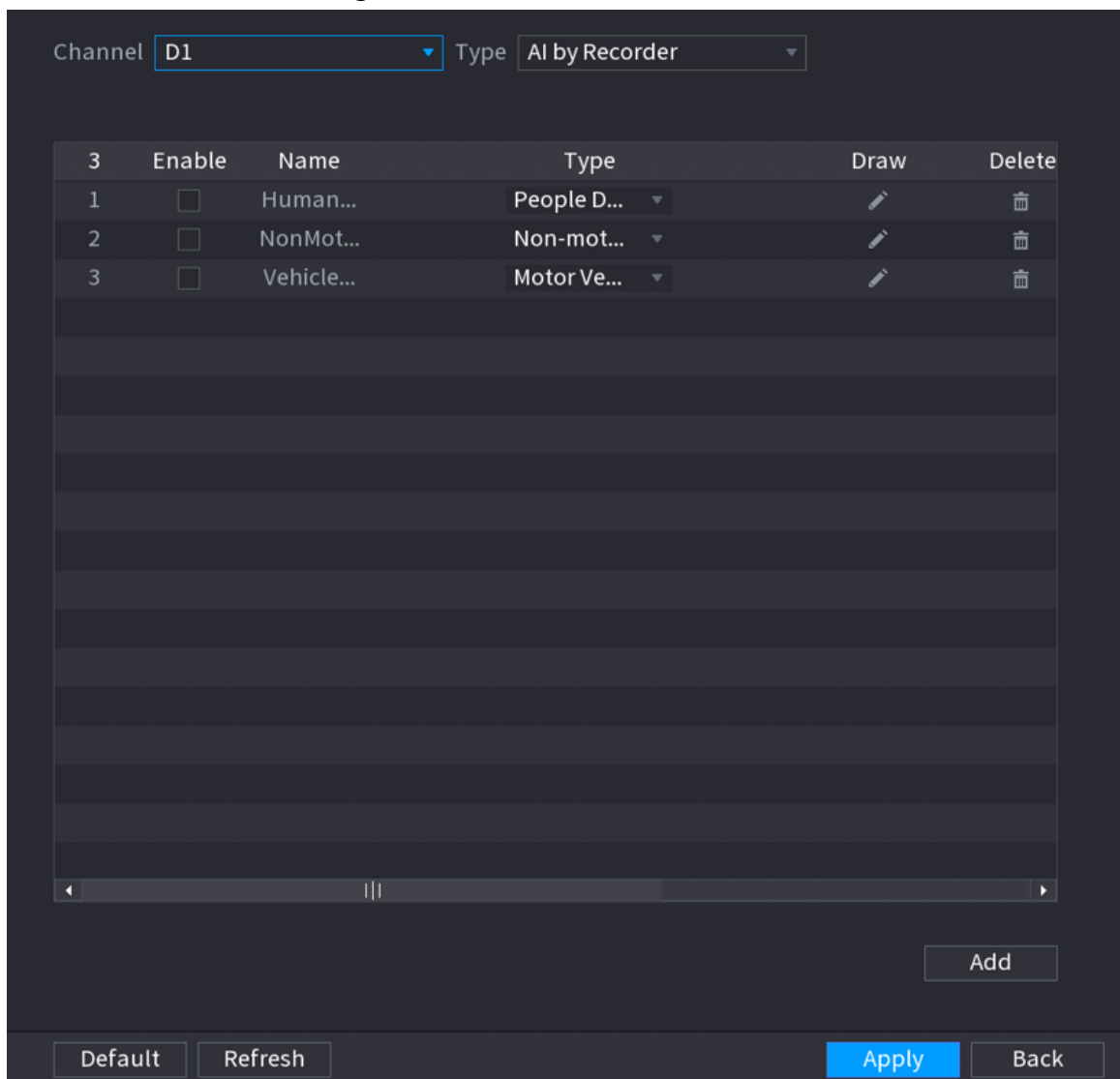

Step 2 Select a channel and Analytics+ type.



Analytics+ by recorder is available on select models.

**Step 3** Click Add to add a rule.

**Step 4** Select Enable and then set Type to People Detection, Non-motor Vehicle Detection or Motor Vehicle Detection.

**Step 5** Draw detection rule.

- 1) Click , and then draw a detection area on the video image. Right-click the image to stop drawing.

Figure 5-140 People detection



- 2) Enter the rule name.

- 3) Click  to draw the minimum size or maximum size to filter the target.

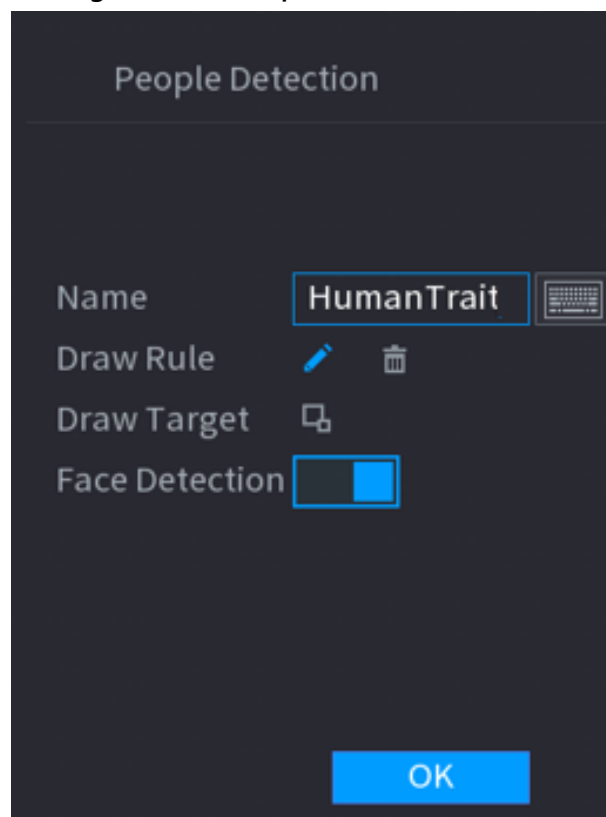
The system triggers an alarm only when the size of detected target is between the maximum size and the minimum size.

- 4) Click  to enable face detection.

- 5) Select A to B, B to A, or Both as direction for tripwire counting.



Tripwire counting is available when Analytics+ by camera is used and the camera supports this function.

- 6) Click OK.

**Step 6** Click Apply.

### 5.9.8.3 Analytics+ Search (Video Metadata)

You can search for the video metadata detection results and play back related videos.

#### 5.9.8.3.1 Human Detection

##### Procedure

**Step 1** Select Main Menu > Analytics+ > Analytics+ Search > Human Detection.

Figure 5-141 Human detection

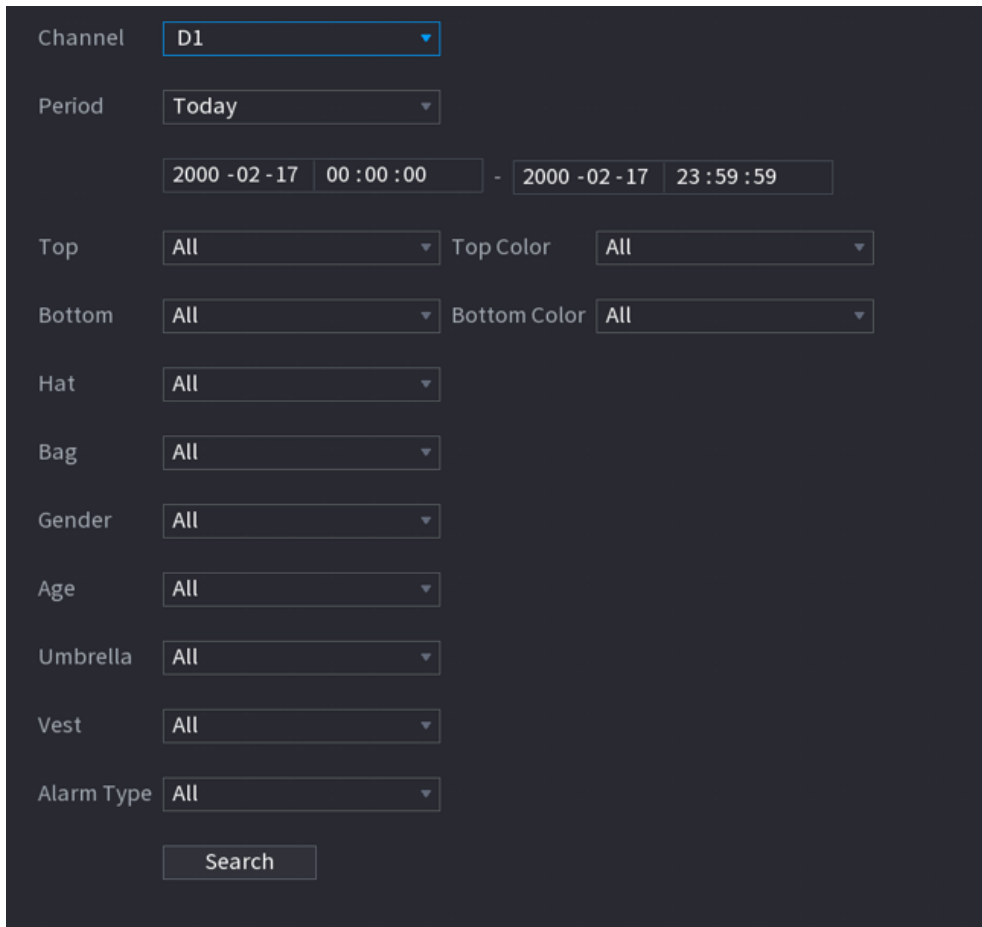

**Step 2** Select a channel, start time, end time, and set corresponding parameters.

**Step 3** Click Search.





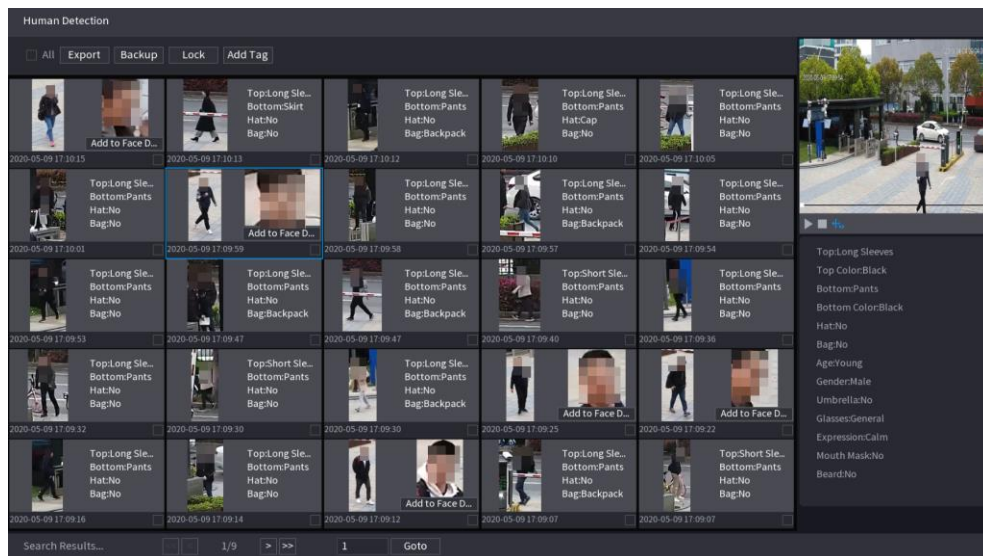

For privacy protection, the faces are intentionally blurred.

Figure 5-142 Search results



## Related Operations

- **Play back video.**  
Click an image, and then click  to play back the related video.  
During playback, you can:
  - ◇ Click  to pause.
  - ◇ Click  to stop.
  - ◇ Click  to display Analytics+ rule. The icon changes to .
- **Add tags.**  
Select one or more images, and then click Add Tag.
- **Lock.**  
Select one or more images, and then click Lock. The locked files will not be overwritten.
- **Export.**  
Select one or more images, and then click Export to export selected search results in excel.
- **Back up.**  
Select one or more images, click Backup, select the storage path and file type, and then click Start to export files to external storage device.

### 5.9.8.3.2 Motor Vehicle Detection

## Background Information

You can search for motor vehicle detection results according to the vehicle parameters.



This function is available on select models.

## Procedure

**Step 1** Select Main Menu > Analytics+ > Analytics+ Search > Motor Vehicle Detection.

Figure 5-143 Motor vehicle detection

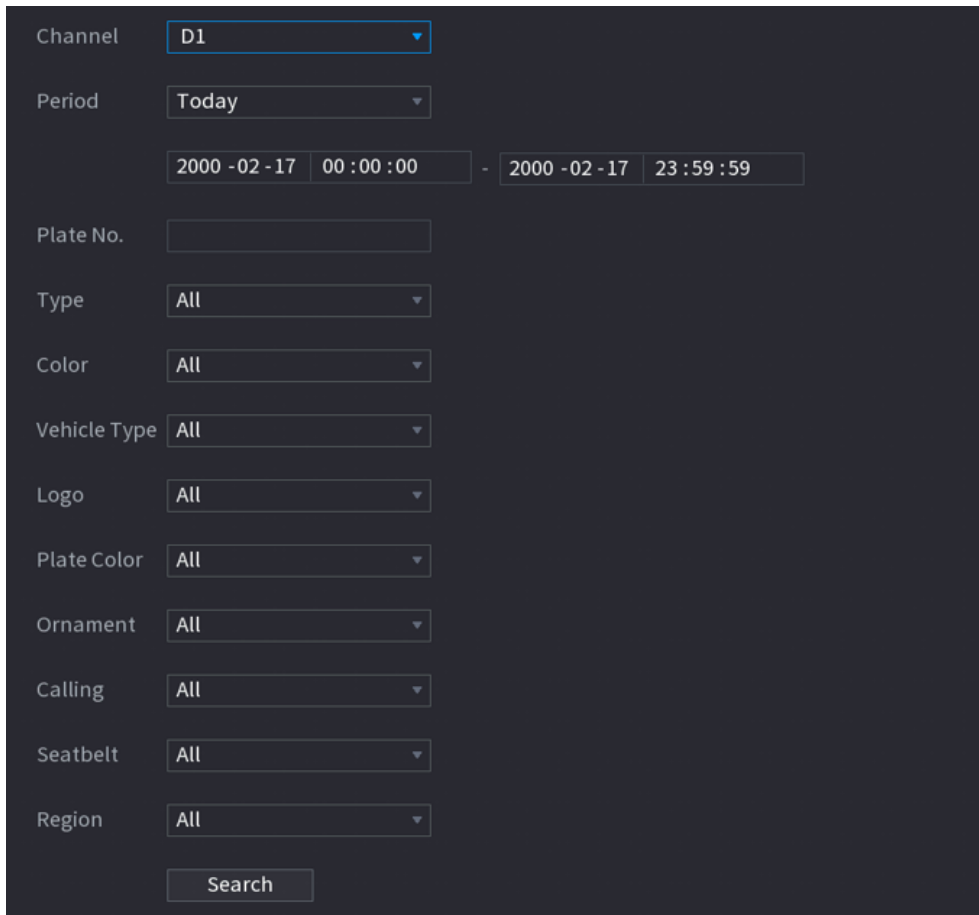

**Step 2** Select a channel and then set parameters.



- The system supports fuzzy search of plate numbers.
- The system searches all plate numbers by default if you have not set a plate number.

**Step 3** Click Search.

The search results are displayed.

## Related Operations

- Play back video.

Click an image, and then click  to play back the related video.

During playback, you can:

- ◇ Click  to pause.
- ◇ Click  to stop.

- ◇ Click to display Analytics+ rule. The icon changes to .
- Add tags.  
Select one or more images, and then click Add Tag.
- Lock.  
Select one or more images, and then click Lock. The locked files will not be overwritten.
- Export.  
Select one or more images, and then click Export to export selected search results in excel.
- Back up.  
Select one or more images, click Backup, select the storage path and file type, and then click Start to export files to external storage device.

### 5.9.8.3.3 Non-motor Vehicle Detection

#### Background Information

You can search for non-motor vehicle detection results according to the non-motor vehicle parameters.



This function is available on select models.

#### Procedure

- Step 1** Select Main Menu > Analytics+ > Analytics+ Search > Non-Motor Vehicle Detection .

Figure 5-144 Non-motor vehicle detection

- Step 2** Select a channel and then set parameters.

**Step 3** Click Search.

**Figure 5-145** Search results

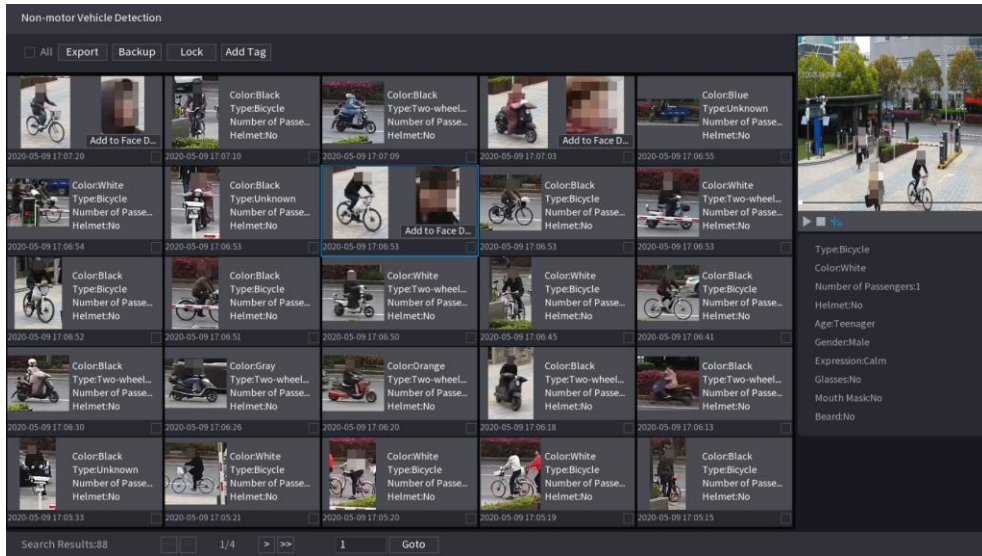





**Related Operations**

- Play back video.

Click an image, and then click  to play back the related video.

During playback, you can:

- ◇ Click  to pause.
- ◇ Click  to stop.
- ◇ Click  to display Analytics+ rule. The icon changes to .

- Add tags.

Select one or more images, and then click Add Tag.

- Lock.

Select one or more images, and then click Lock. The locked files will not be overwritten.

- Export.

Select one or more images, and then click Export to export selected search results in excel.

- Back up.

Select one or more images, click Backup, select the storage path and file type, and then click Start to export files to external storage device.

**5.9.8.3.4 Report Query**

**Background Information**

You can search for and export video metadata statistics.



- The statistics might be overwritten when the storage space runs out. Back up in time.
- When you restore the Device to factory settings, all the data except data in the external storage device will be cleared. You can clear the data in the external storage device through formatting or other methods.

## Procedure

**Step 1** Select Main Menu > Analytics+ > Report Query > Video Metadata.

Figure 5-146 Metadata statistics

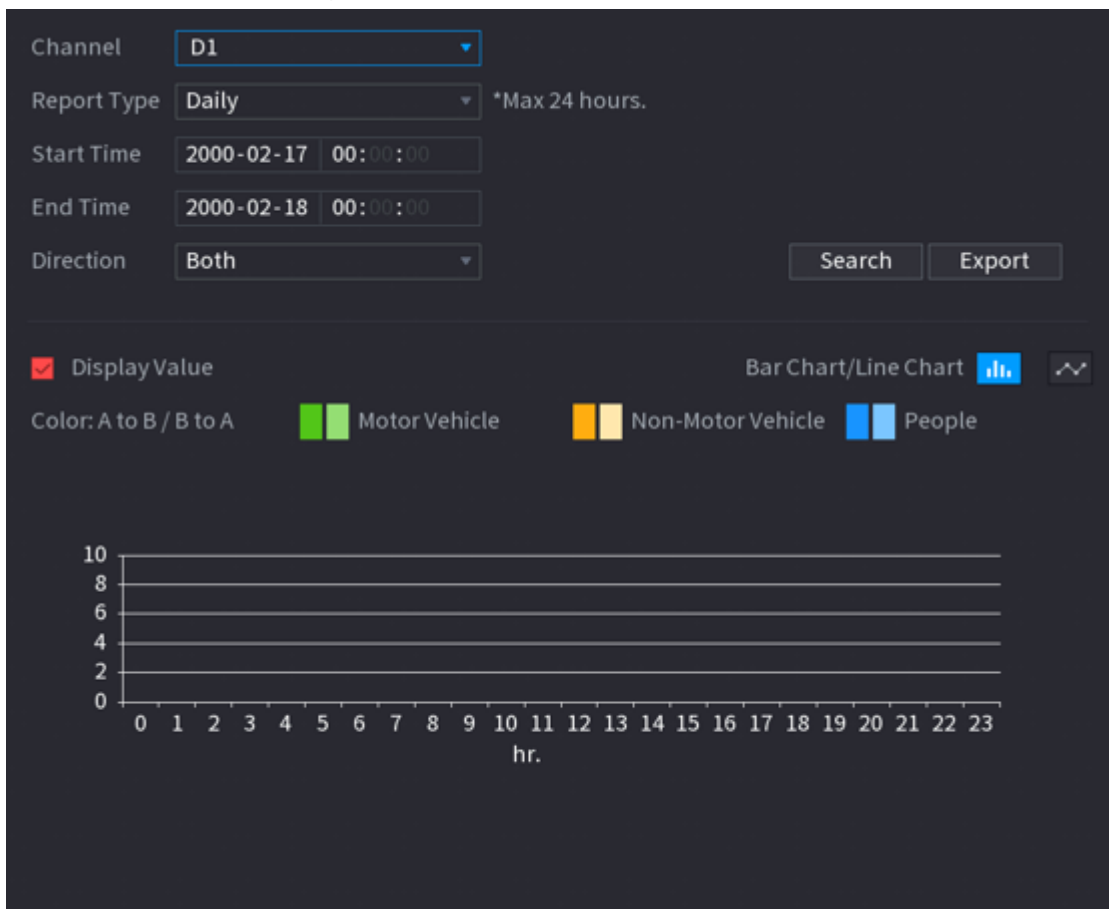

**Step 2** Select channel, report type, start time and end time, direction and then click Search.

## Related Operations

- Switch chart type.  
Click Bart Chart or Line Chart to switch the chart type.
- Export.  
Select file type, and then click Export to export the report in picture or csv format.

### 5.9.9 ANPR

The system extracts the plate number on the security video and then compare it with the specified plate information. When a match is detected, the system triggers an alarm.





- Import and export plate information.
  - ◇ Import: Click Import, select the corresponding file, and then click Browse to import the file.
  - ◇ Export: Click Export, select the file storage path and then click Save.
- Delete plate information.
  - ◇ Delete one by one: Click the  of the corresponding plate number.
  - ◇ Delete in batches: Select the plate numbers and then click Delete.

## 5.9.9.2 Configuring ANPR

### Background Information

Configure the ANPR alarm rules.

### Procedure

**Step 1** Select Main Menu > Analytics+ > Parameters > ANPR.

Figure 5-148 ANPR

**Step 2** Select a channel and then select the Enable checkbox to enable ANPR.

**Step 3** (Optional) Enable Sync Vehicle Blocklist/Allowlist to synchronize the blocklist and allowlist on the NVR to the connected camera.

**Step 4** Click General (default), Blocklist or Allowlist tab.



Before enabling the blocklist alarm or allowlist alarm, you need to add the corresponding plate information.

- General: The system triggers an alarm when it detects any plate number.
- Block List: The system triggers an alarm when it detects plate number on the blocklist.
- Allow List: The system triggers an alarm when it detects plate number on the allowlist.

**Step 5** Click Setting next to Schedule to configure the arming period.

The system triggers corresponding alarm actions only during the arming period.

- On the time line, drag to set the period.
- You can also click  to set the period.

**Step 6** Configure alarm linkage actions. For details, see [Step 7](#).

**Step 7** Click Apply.

### 5.9.9.3 Analytics+ Search (ANPR)

You can search for the ANPR detection results. For details, see "5.9.8.3.2 Motor Vehicle Detection".

## 5.9.10 Crowd Distribution

The system detects the crowd distribution. When the crowd density exceeds the defined threshold, an alarm is triggered.

### 5.9.10.1 Enabling Smart Plan

To use Analytics+ by camera, you need to enable the smart plan first. For details, see "5.9.2 Smart Plan".

### 5.9.10.2 Configuring Crowd Distribution

Configure the alarm rules of crowd distribution detection.

#### Prerequisites

Make sure that the connected camera supports the crowd distribution function.

#### Background Information

#### Procedure

**Step 1** Select Main Menu > Analytics+ > Parameters > Crowd Distribution.

Figure 5-149 Crowd distribution

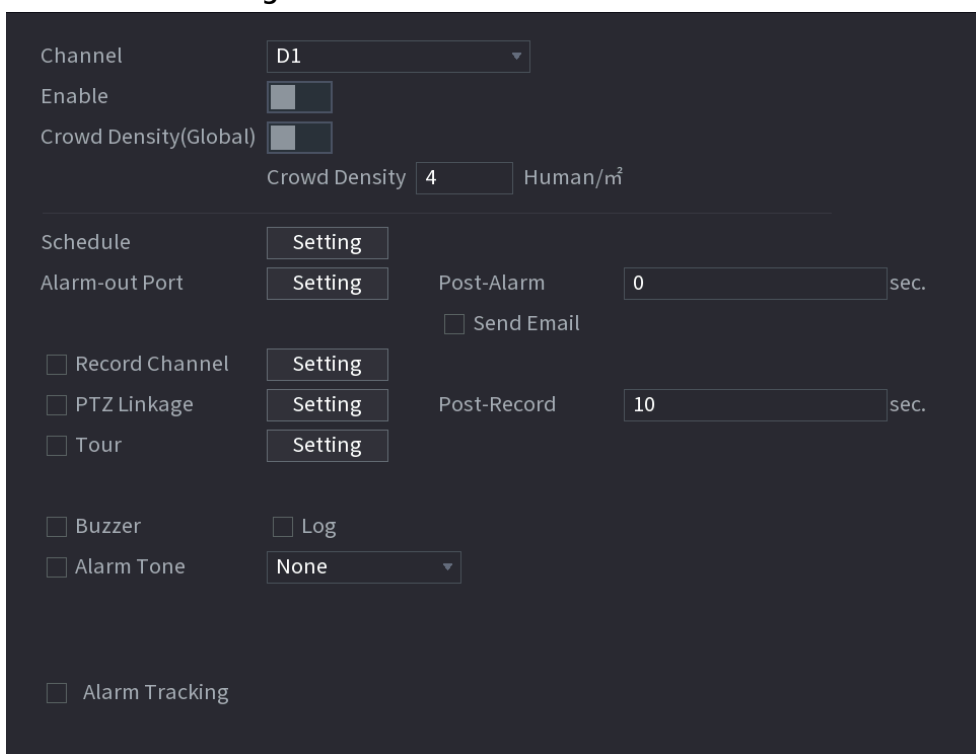

**Step 2** Select a channel and then click  next to Enable.

**Step 3** Configure parameters.

Table 5-41 Crowd distribution parameters

Parameter	Description
Crowd Density (Global)	Click  and then configure the density threshold.
Crowd Density	
Alarm Tracking	After an alarm occurs, the system tracks the target automatically.

**Step 4** Click Setting next to Schedule to configure the arming period.

The system triggers corresponding alarm actions only during the arming period.

- On the time line, drag to set the period.
- You can also click  to set the period.

**Step 5** Configure alarm linkage actions. For details, see [Step7](#).

**Step 6** Click Apply.

### 5.9.10.3 Report Query

#### Background Information

You can search for and export video metadata statistics.



- The statistics might be overwritten when the storage space runs out. Back up in time.
- When you restore the Device to factory settings, all the data except data in the external storage device will be cleared. You can clear the data in the external storage device through formatting or other methods.

## Procedure

Step 1 Select Main Menu > Analytics+ > Report Query > Crowd Density.

Step 2 Select the channel, report type, start time and end time, and then click Search.

## Related Operations

- Switch chart type.  
Click Bart Chart or Line Chart to switch the chart type.
- Export.  
Select the file type, and then click Export to export the report in picture or csv format.

## 5.9.11 People Counting

The system can calculate the number of entry or exit people in the detection zone. An alarm is triggered when the number has exceeded the threshold.



Make sure that the connected camera supports people counting.

### 5.9.11.1 Enabling Smart Plan

To use Analytics+ by camera, you need to enable the smart plan first. For details, see "5.9.2 Smart Plan".

### 5.9.11.2 Configuring People Counting

#### Background Information

The system counts the number of people in and out of the detection area. When the number of entry, exit or staying people exceeds the threshold, an alarm is triggered.

#### Procedure

Step 1 Select Main Menu > Analytics+ > Parameters > People Counting > People Counting.

Figure 5-150 People counting

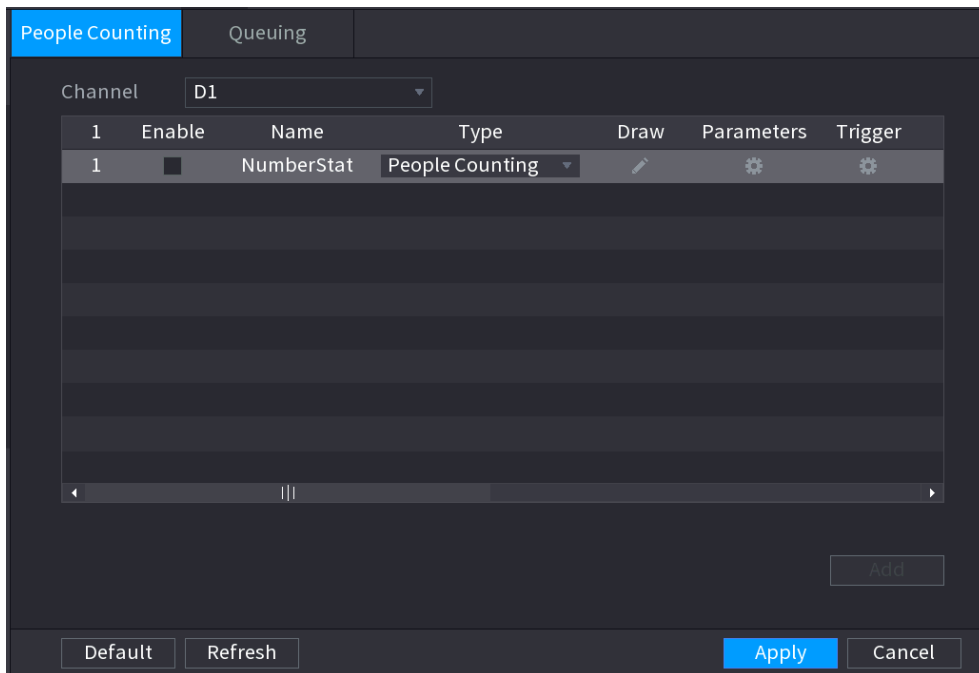

**Step 2** Select a channel and then click Add.

**Step 3** Select the Enable checkbox and then set Type to People Counting.

**Step 4** Draw people counting rule.

- 1) Click to draw people counting rule. Right-click the image to stop drawing.

Figure 5-151 People counting rule

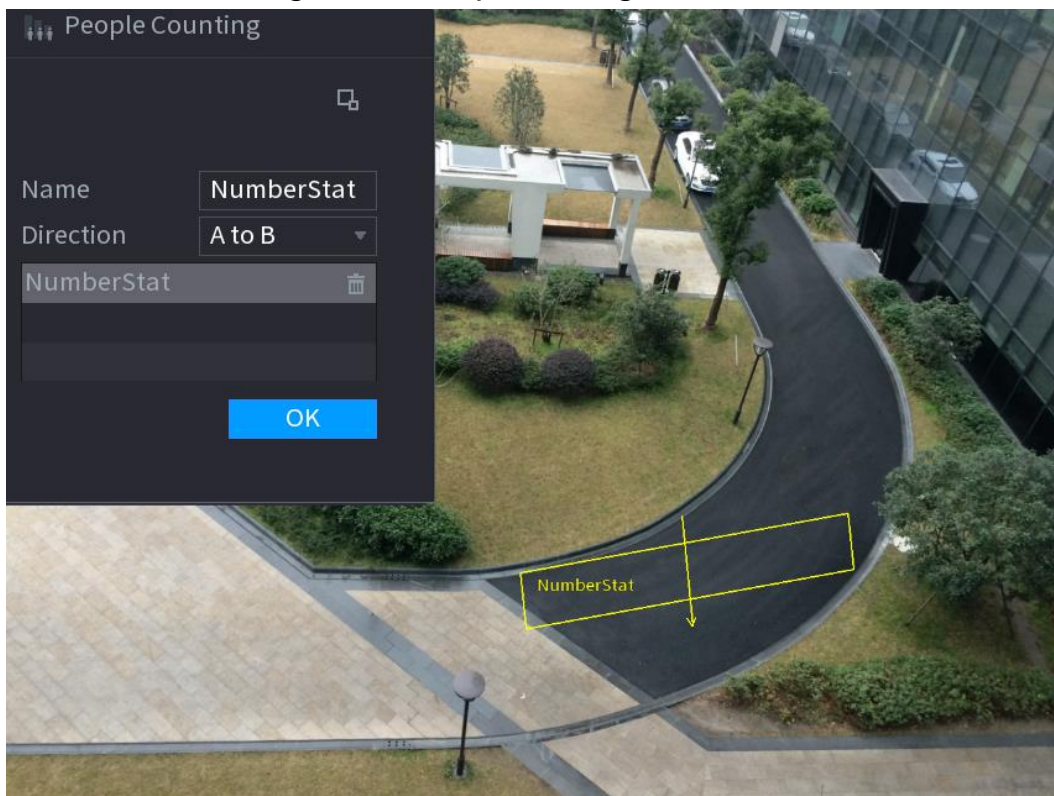

2) Customize the rule name and then select direction.

3) Click OK.

**Step 5** Click under Parameters and then configure the parameters.

Table 5-42 People counting parameters

Parameter	Description
OSD	<ul style="list-style-type: none"> <li>• Select Enter No., and then the number of people entering the detection zone will be displayed on the live page.</li> <li>• Select Exit No., and then the number of people leaving the detection zone will be displayed on the live page.</li> </ul>
Setting	<ul style="list-style-type: none"> <li>• Enter No.: An alarm is triggered when the number of people entering the detection zone exceeds the defined threshold.</li> <li>• Exit No.: An alarm is triggered when the number of people leaving the detection zone exceeds the defined threshold.</li> <li>• Stay No.: An alarm is triggered when the number of people staying the detection zone exceeds the defined threshold.</li> </ul>

**Step 6** Click  under Trigger to configure alarm schedule and linkage. For details on alarm linkage, see Table 5-43.

**Step 7** Click Apply.

### 5.9.11.3 Configuring In Area No.

#### Background Information

When the number of people in the detection area is larger or lower than the defined threshold, or when the staying period exceeds the defined duration, an alarm is triggered.

#### Procedure

**Step 1** Select Main Menu > Analytics+ > Parameters > People Counting > People Counting.

Figure 5-152 People counting

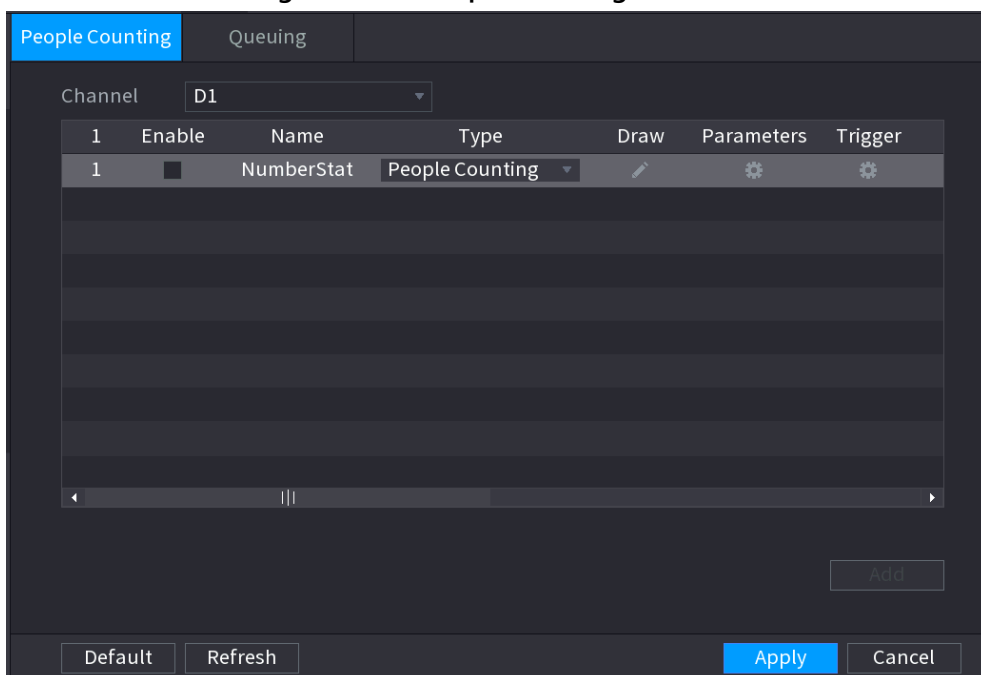

- Step 2** Select a channel and then click Add.
- Step 3** Select the Enable checkbox and then set Type to In Area No.
- Step 4** Draw people counting rule.
  - 1) Click to draw a rule. Right-click the image to stop drawing.
  - 2) Configure the parameters.
  - 3) Click OK.
- Step 5** Click and then enable in-area people number alarm and stay alarm.
- Step 6** Click under Trigger to configure the alarm schedule and linkage
- Step 7** Click Apply.

### 5.9.11.4 Queuing

#### Background Information

After configuring queuing alarm, the system can realize the corresponding linkage actions once the number of people in the queue or the waiting time has triggered an alarm.

#### Procedure

- Step 1** Select Main Menu > Analytics+ > Parameters > People Counting > Queuing.

Figure 5-153 Queuing

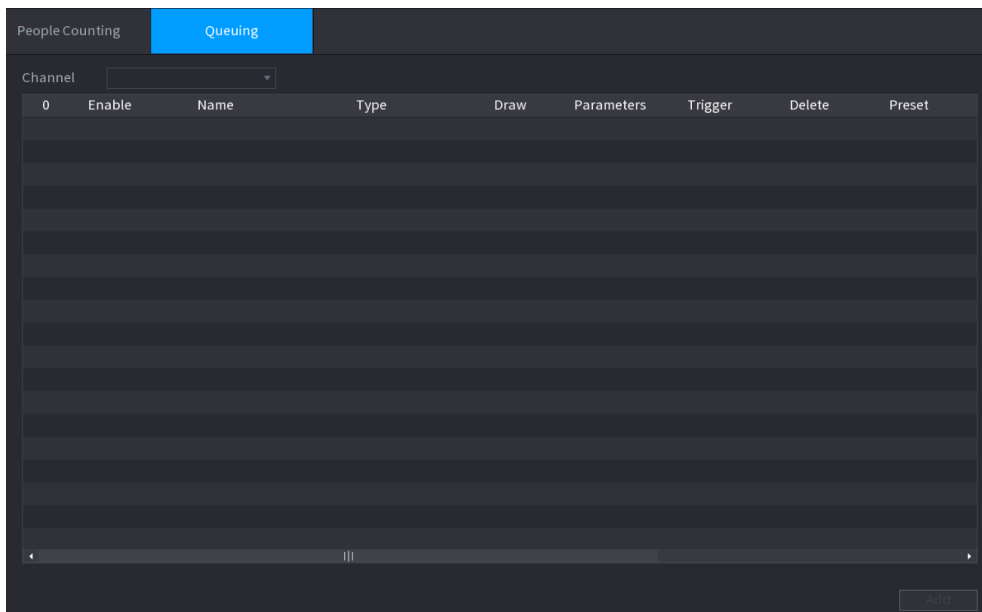

- Step 2** Select a channel, and then click Add.
- Step 3** Select the Enable checkbox.
- Step 4** Click to draw queuing rule and area.
- Step 5** Click under Parameters, and then enable Queue People No. Alarm or Queue Time Alarm.
- Step 6** Click under Trigger to configure alarm schedule and linkage.
- Step 7** Click Apply.



## 5.9.11.5 Report Query

### Background Information

You can search for and export the people counting statistics.



- The statistics might be overwritten when the storage space runs out. Back up in time.
- When you restore the Device to factory settings, all the data except data in the external storage device will be cleared. You can clear the data in the external storage device through formatting or other methods.

### Procedure

**Step 1** Select Main Menu > Analytics+ > Report Query > People Counting.

Figure 5-154 People counting

**Step 2** Select channel, rule, report type, start and end time, and direction, and then click Search.

### Related Operations

- Switch chart type.  
Click Bart Chart or Line Chart to switch the chart type.
- Export.  
Select file type, and then click Export to export the report in picture or csv format.

## 5.9.12 Heat Map

The Device can monitor the distribution of active objects in the detection zone during a period of time, and use different colors to display the objects on the heat map.

### 5.9.12.1 Enabling Smart Plan

To use Analytics+ by camera, you need to enable the smart plan first. For details, see "5.9.2 Smart Plan".

### 5.9.12.2 Configuring Heat map

#### Background Information

Heat map technology can monitor the active objects distribution status on the specified zone during a period of time, and use different colors to display on the heat map.

#### Procedure

**Step 1** Select Main Menu > Analytics+ > Parameters > Heat Map.

Figure 5-155 Heat map

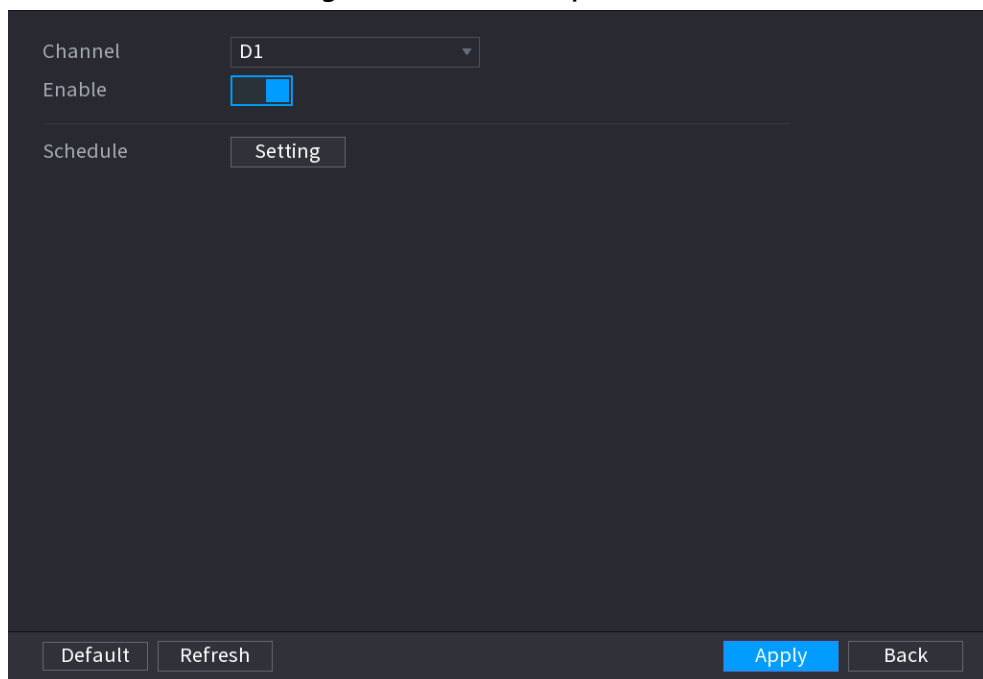

**Step 2** Select a channel and then click  to enable the function.

**Step 3** Click Setting to configure the alarm schedule.

Figure 5-156 Schedule

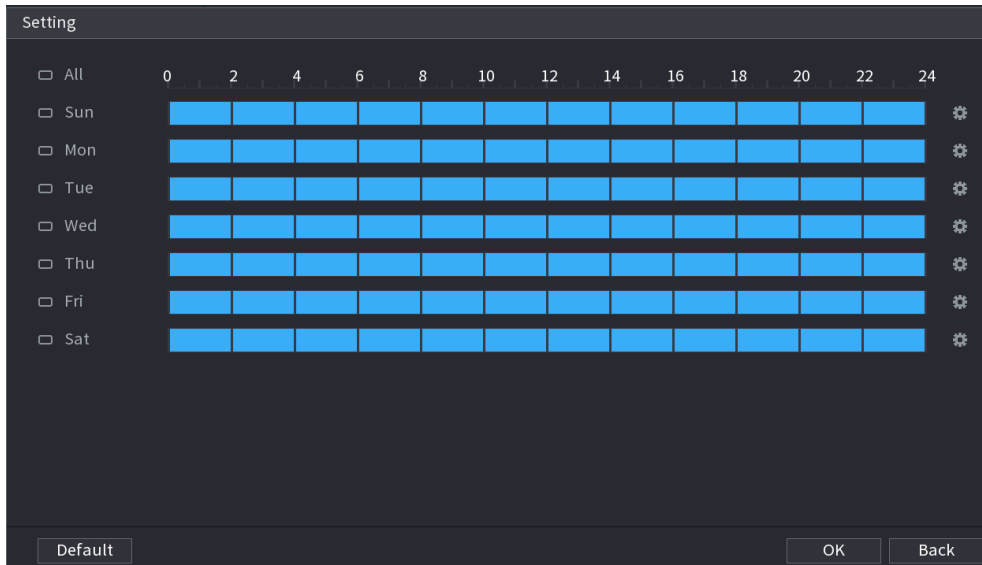

**Step 4** Click Apply.

### 5.9.12.3 Report Query

You can search for and export the heat map report of general and fisheye cameras.

#### 5.9.12.3.1 General

#### Procedure

**Step 1** Select Main Menu > Analytics+ > Report Query > Heat Map > General.

Figure 5-157 General

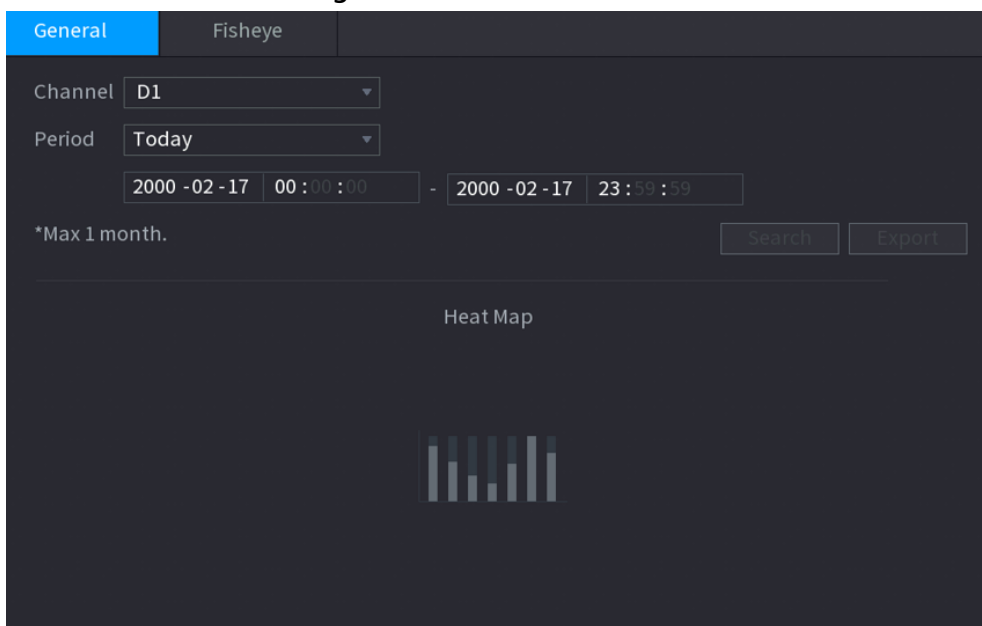

**Step 2** Select the channel, start time, and end time.

**Step 3** Click Search.

**Step 4** Click Export to export the heat map.

### 5.9.12.3.2 Fisheye

#### Procedure

**Step 1** Select Main Menu > Analytics+ > Report Query > Heat Map > Fisheye.

Figure 5-158 Fisheye

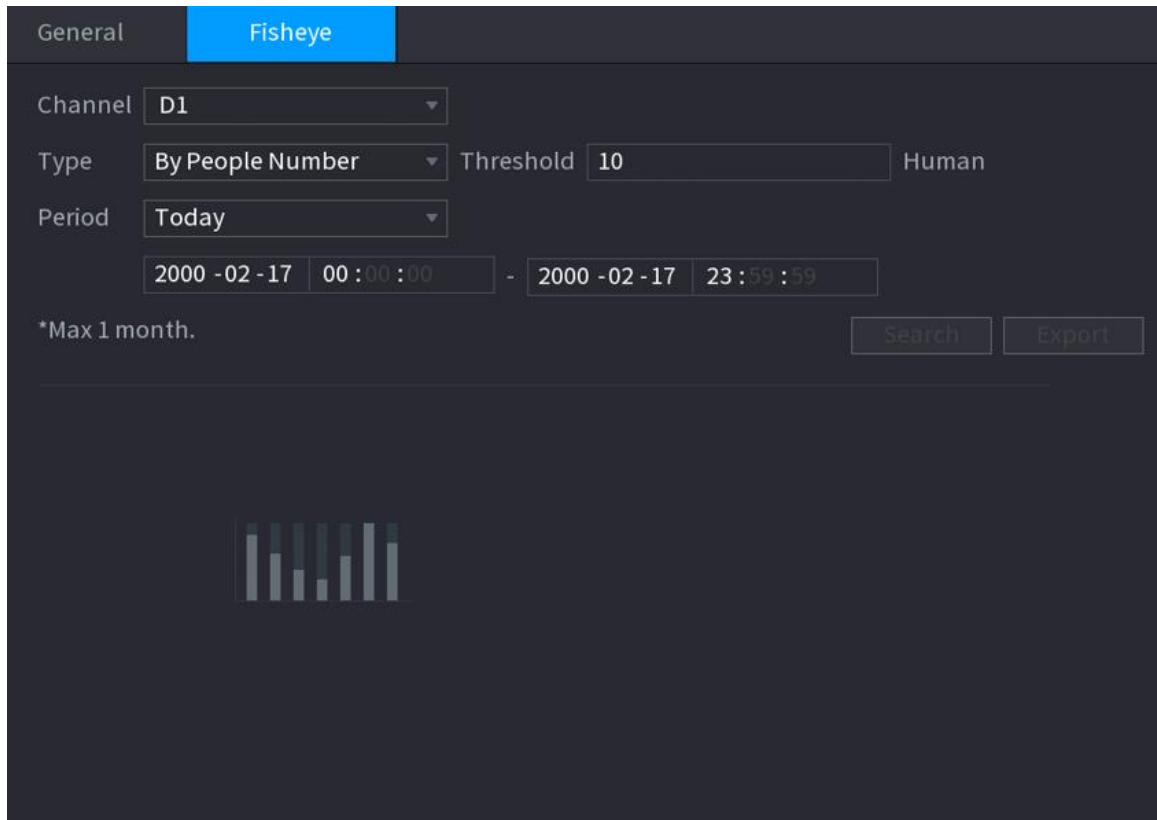

**Step 2** Set channel, type and period, and then click Search.

**Step 3** Click Export to export the heat map.

## 5.9.13 SMD

You can use SMD (Smart Motion Detection) to detect humans and vehicles in the video, and store the detection results in structured storage for fast retrieval.

### 5.9.13.1 Enabling Smart Plan

To use Analytics+ by camera, you need to enable the smart plan first. For details, see "5.9.2 Smart Plan".

### 5.9.13.2 Configuring SMD

#### Procedure

**Step 1** Select Main Menu > Analytics+ > Parameters > SMD.

Figure 5-159 SMD

**Step 2** Select a channel and Analytics+ type.

**Step 3** Click  to enable the function.

**Step 4** Configure the sensitivity.

The higher the value, the easier it is to trigger an alarm. But meanwhile, the false alarm might occur. The default value is recommended.







**Step 5** Select effective target from Human and Motor Vehicle.



**Step 6** Click Setting next to schedule to configure the alarm period.

**Step 7** Configure alarm linkage.

Table 5-43 Alarm linkage parameters

Parameter	Description
Anti-Dither	The system records only one motion detection event within the defined period.
Alarm-out Port	When an alarm occurs, the NVR links the alarm output device to

Parameter	Description
Post-Alarm	<p>generate an alarm. The alarm lasts a period of time depending on the defined value for Post-Alarm.</p>  <ul style="list-style-type: none"> <li>• Make sure that the alarm devices are connected to the alarm output port of NVR.</li> <li>• In Main Menu &gt; ALARM &gt; Alarm-out Port, set the mode to Auto so that the system can link the alarm output device to generate an alarm.</li> </ul>
Show Message	Enable on-screen prompt when an alarm occurs.
Report Alarm	<p>Enable the system to report the alarm to the alarm center.</p>  <p>Make sure that alarm center has been configured in Main Menu &gt; NETWORK &gt; Alarm Center.</p>
Send Email	<p>Enable the system to send an email to notify you when an alarm occurs.</p>  <p>Make sure that the email settings have been configured in Main Menu &gt; NETWORK &gt; Email.</p>
Record Channel	When an alarm occurs, the system activates recording of the selected channel. After the alarm ends, the recording continues for a period of time depending on the defined value for Post-Record.
Post-Record	 <p>Make sure that intelligent recording schedule and auto recording have been configured. For details, see "5.8.1 Recording Schedule".</p>
PTZ Linkage	<p>When an alarm occurs, the NVR associates the channel to perform the corresponding PTZ action. For example, rotate the PTZ to the preset point.</p>  <p>Make sure that PTZ actions have been configured. For details, see "5.6.7 PTZ".</p>
Tour	<p>When an alarm occurs, the local interface of the NVR displays the image of the selected channels in turn.</p>  <p>Make sure that the time interval and mode for tour have been configured in Main Menu &gt; DISPLAY &gt; Tour Setting.</p>

Parameter	Description
Picture Storage	When an alarm occurs, the system takes a snapshot of the channel and stores the snapshot on the Device.  Make sure that snapshot schedule and snapshot mode have been configured. For details, see "5.8.1 Recording Schedule".
Buzzer	The system activates the buzzer when an alarm occurs.
Log	When an alarm occurs, the system records the event in the logs.
Alarm Tone	When an alarm occurs, the system plays the selected audio file.  Make sure that the audio files have been uploaded to the system. For details, see "5.18.1 File Management".

**Step 8** Click Apply.

### 5.9.13.3 Analytics+ Search (SMD)

You can search for and play back videos that triggered SMD alarms.

#### Procedure

**Step 1** Select Main Menu > Analytics+ > Analytics+ Search > SMD.

**Step 2** Select channel, type, start time and end time, and then click Search.

- Click  to play back the video.
- Select a video and click Export to export video file to a USB flash drive.

### 5.9.14 Vehicle Density

You can configure the rules for traffic congestion and parking upper limit, , and view the counting data on the live page.

- **Traffic congestion:** The system counts the vehicles in the detection area. When the counted vehicle number and the continuous congestion time exceed the configured values, an alarm is triggered and the system performs an alarm linkage.
- **Parking upper limit:** The system counts the vehicles in the detection area. When the counted vehicle number exceeds the configured value, an alarm triggered and the system performs an alarm linkage.

#### 5.9.14.1 Enabling Smart Plan

To use Analytics+ by camera, you need to enable the smart plan first. For details, see "5.9.2 Smart Plan".







- The statistics might be overwritten when the storage space runs out. Back up in time.
- When you restore the Device to factory settings, all the data except data in the external storage device will be cleared. You can clear the data in the external storage device through formatting or other methods.

## Procedure

**Step 1** Select Main Menu > Analytics+ > Report Query > Vehicle Density.

Figure 5-161 Vehicle density

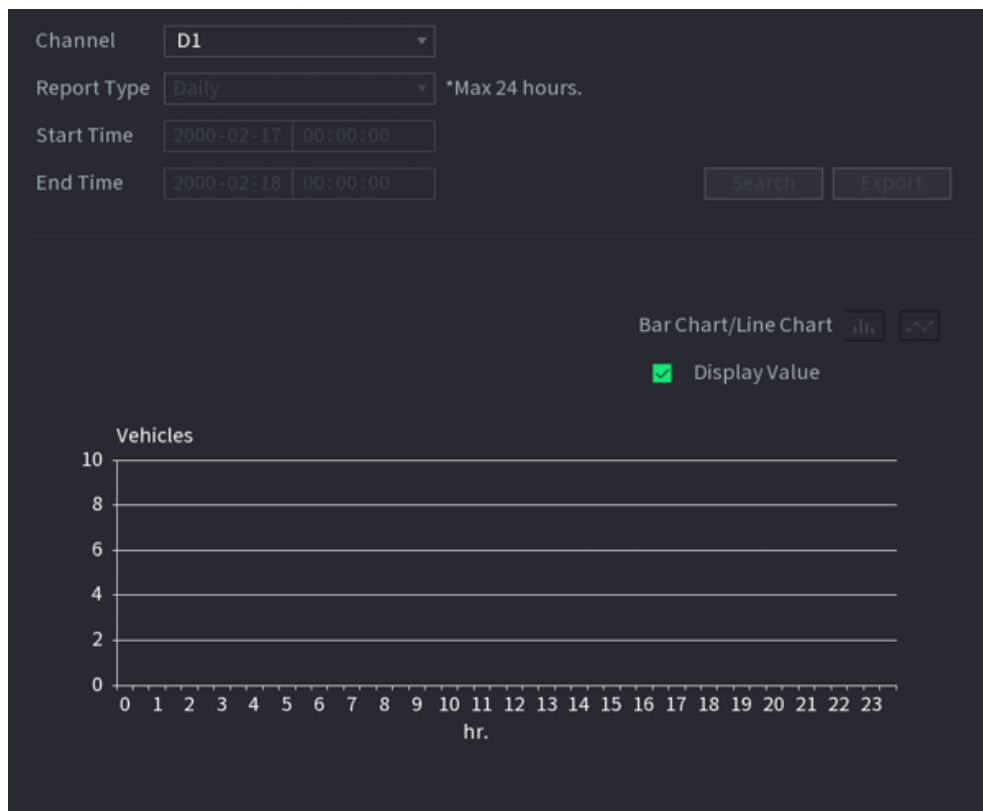

**Step 2** Select channel, report type, start and end time, and then click Search.

## Related Operations

- Switch chart type.  
Click Bart Chart or Line Chart to switch the chart type.
- Export.  
Select file type, and then click Export to export the report in picture or csv format.

## 5.9.15 Main-sub Tracking

Main-sub tracking refers to fisheye camera and speed dome linkage system. The fisheye camera serves as the main camera and captures panoramic videos. The speed dome serves as the sub camera and captures details of the video.

### Prerequisites

- The monitoring areas of fisheye camera and speed dome are the same area.
- Fisheye camera and speed dome are added through private protocol.

### Background Information



This function is available on select models.

### Procedure

**Step 1** Select Main Menu > Analytics+ > Parameters > Main-Sub Tracking.

**Step 2** Add monitoring area.

- 1) Click Add.
- 2) Configure parameters.

Table 5-44 Main-sub tracking parameters

Parameter	Description
Type	Select a type according to the number of fisheye and PTZ cameras: <ul style="list-style-type: none"> <li>• 1 Fisheye + 1 PTZ.</li> <li>• 1 Fisheye + 2 PTZ.</li> <li>• 1 Fisheye + 3 PTZ.</li> </ul>
Scene Name	Customize the scene name.
Main Camera	Select a fisheye camera. <ol style="list-style-type: none"> <li>1. Click Select in Main Camera line.</li> <li>2. Select a fisheye camera.</li> <li>3. Click Apply.</li> </ol>
Sub Camera	Select speed domes as needed. <ol style="list-style-type: none"> <li>1. Click Select in Sub Camera line.</li> <li>2. Select speed domes.</li> <li>3. Click Apply.</li> </ol>



**Step 3** Click Apply.

The monitoring area is successfully added.

**Step 4** Configure calibration points to set the binding relationship of fisheye camera and speed dome.



Set a distant place as the first calibration point to improve accuracy.

- 1) Click  or double-click the target scene.
- 2) Click the target place on the video of fisheye camera, or move  to the target place.



The video at upper-left corner is the fisheye camera screen, and the video at upper-right corner is the speed dome screen.









- 3) Adjust position through the icons below the speed dome screen to make the center of speed dome identical to the  of fisheye camera.  
The  on the speed dome screen is the center of speed dome.

Table 5-45 Icon description

Icon	Description
	Zoom in and zoom out.
	Adjust resolution.
	Adjust height.
	Electronic mouse. You can use this icon to move the mouse to control PTZ direction.
	Quick positioning key. Click this icon to select a place, and the screen will be focused and centered on the selected place.

- 4) Click Add.

The calibration point will be displayed on the list at lower-right corner.

**Step 5** Click  to save the newly added calibration point.

**Step 6** Repeat Step 2 to Step 5 to add more calibration points.



Set 3–8 calibration points for a speed dome.

**Step 7** Click Apply.

## 5.9.16 Video Quality Analytics

When conditions such as blurry, overexposure, or the color changes appear on the screen, the system triggers the alarm.



- This function takes effect only when the remote IPC supports video quality analytics.
- This function is available on select models.

### 5.9.16.1 Configuring Video Quality Analytics

#### Procedure

**Step 1** Select Main Menu > Analytics+ > Parameters > Video Quality Analytics.

**Step 2** Select a channel and click Enable.

Figure 5-162 Video quality analytics

Channel: D1

Enable:

Rule: [Setting](#)

Schedule: [Setting](#)

Alarm-out Port: [Setting](#) Post-Alarm: 10 sec.

Show Message  Report Alarm  Send Email

Buzzer  Log

Alarm Tone: None

[Default](#) [Apply](#) [Back](#)

**Step 3** Click Setting next to Rule.

**Step 4** Select items and set thresholds as needed.

Figure 5-163 Video quality analytics settings

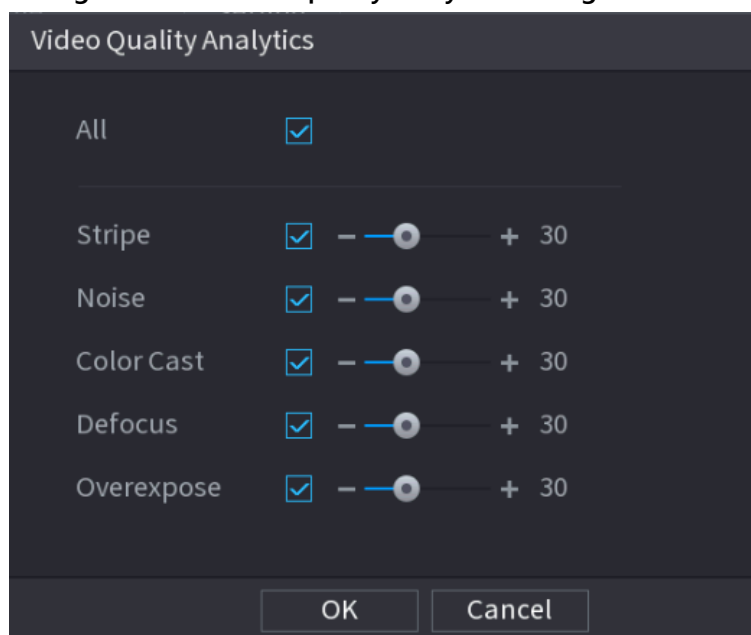

The value range of threshold is 0–100, and the default value is 30. When the value exceeds the set threshold, an alarm will be triggered.

Table 5-46 Video quality analytics parameters

Parameter	Description
Stripe	Stripes refer to the striped interferences in the video which might be due to device aging or signal interference. The stripe might be horizontal, vertical, or oblique.
Noise	Video noise refers to the distortion of optical system or the degradation of image quality caused by hardware equipment during transmission.
Color Cast	An image in the video is generally a colorful image that contains color information, such as RGB. When these three components appear at some unusual scale in an image, the image is biased.
Defocus	An image with high resolution contains more details, but image blur is a common problem of image quality decrease which is caused by many factors in the process of image acquisition, transmission and processing, and is defined as virtual focus in video diagnosis.
Overexpose	The brightness of the image refers to the intensity of the image pixels. Black is the darkest and white is the brightest. Black is represented by 0 and white is represented by 255. When the brightness value exceeds the threshold, the image is over exposed.

**Step 5** Click OK.

**Step 6** Click Setting next to Schedule to configure the arming period.

The system triggers corresponding alarm actions only during the arming period.

- On the time line, drag to set the period.
- You can also click  to set the period.

**Step 7** Configure alarm linkage actions. For details, see [Step7](#).

**Step 8** Click Apply.

### 5.9.16.2 Analytics List

#### Background Information

Search for the results of video quality analytics.

#### Procedure

**Step 1** Select Main Menu > Analytics+ > Analytics+ Search > Analytics List.

**Step 2** Select the start time and end time.

**Step 3** Select one or more channels.

**Step 4** Click Search.

Figure 5-164 Analytics list

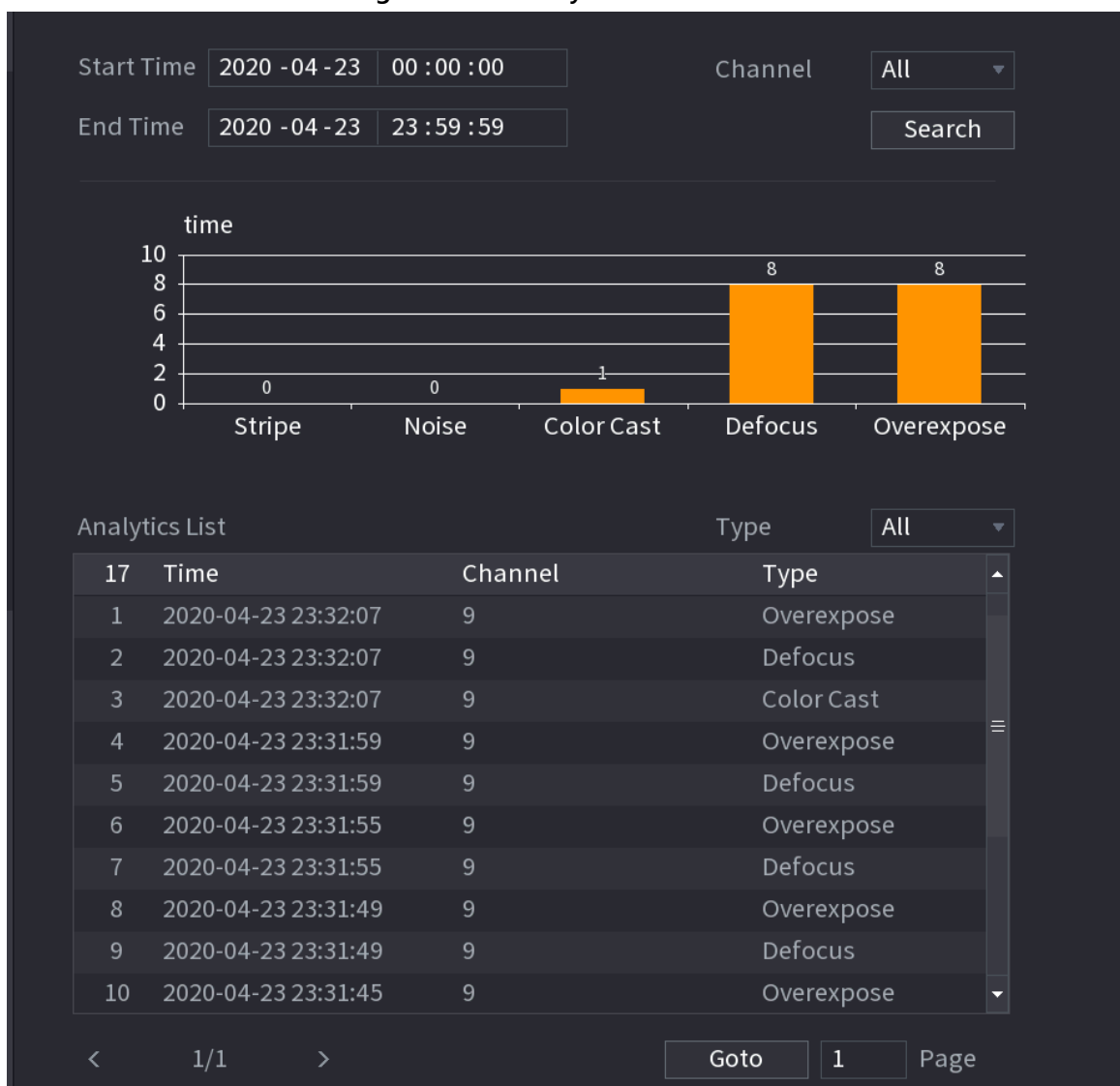

## 5.9.17 Entries Frequency

### Background Information

After setting entries frequency, when the entries detected of a person reach or exceed the threshold, an alarm is triggered.

### Procedure

**Step 1** Select Main Menu > Analytics+ > Parameters > Face Detection+ > Entries Frequency.

Figure 5-165 Entries frequency

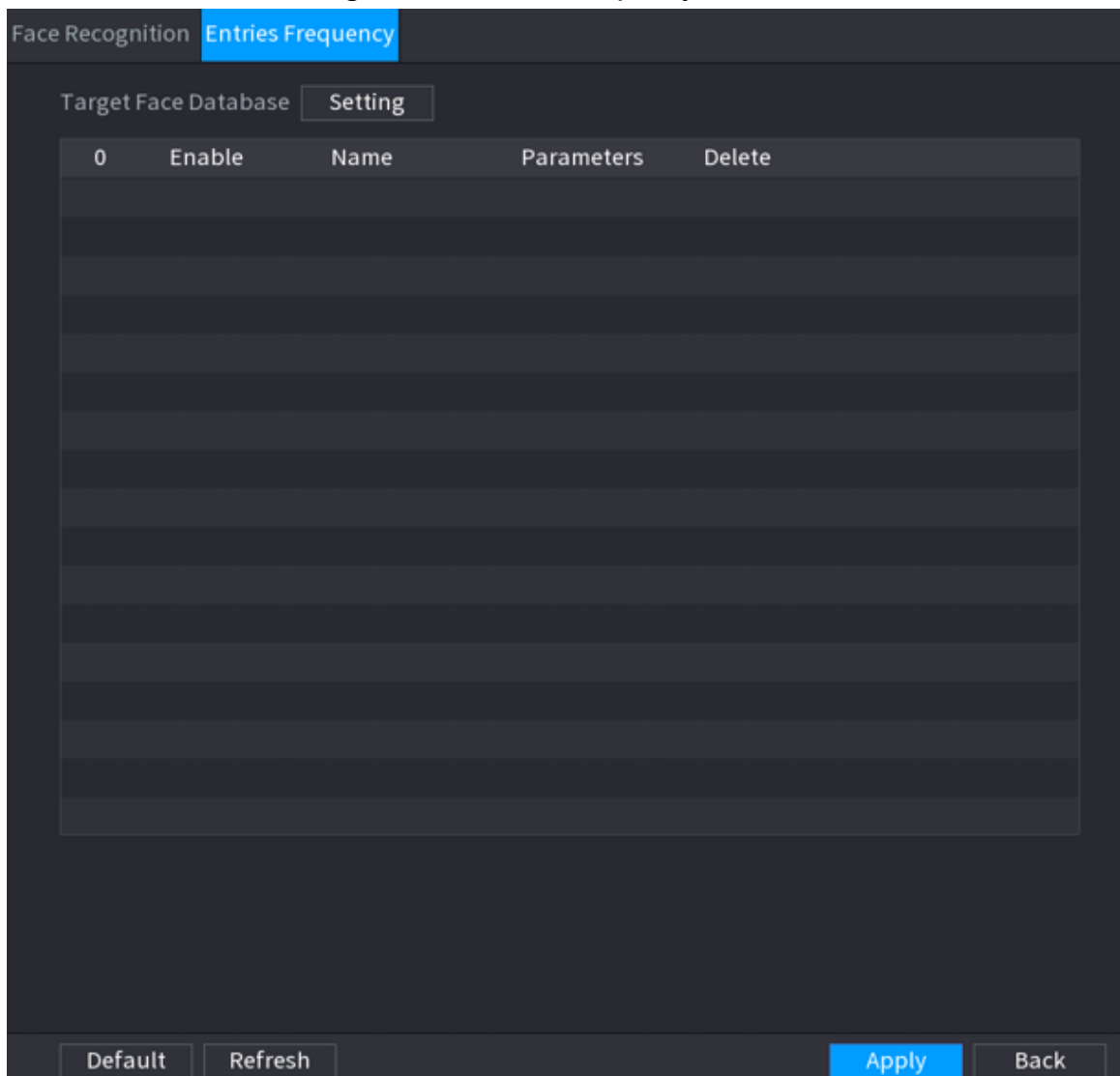

**Step 2** Click Setting to select a database and then click OK.

**Step 3** Click  and then configure the parameters.

Figure 5-166 Configure entries frequency

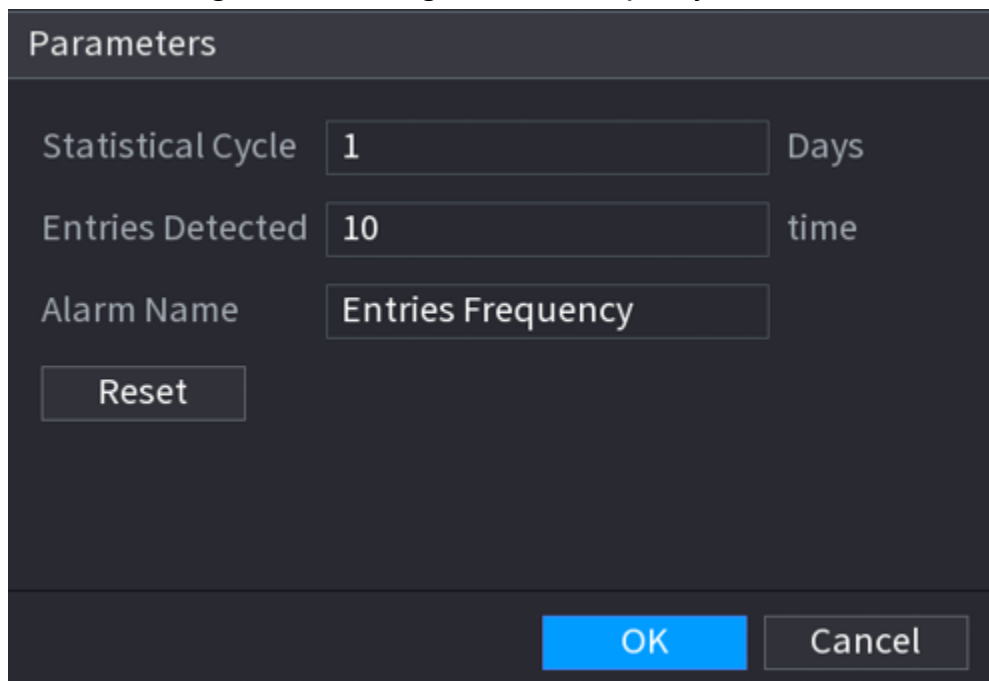

The screenshot shows a dark-themed dialog box titled "Parameters". It contains three input fields: "Statistical Cycle" with the value "1" and the unit "Days" to its right; "Entries Detected" with the value "10" and the unit "time" to its right; and "Alarm Name" with the value "Entries Frequency". Below these fields is a "Reset" button. At the bottom right of the dialog are two buttons: "OK" (highlighted in blue) and "Cancel".

Table 5-47 Entries frequency parameters

Parameter	Description
Statistical Cycle	Set the cycle for counting the entries frequency.
Entries Detected	Set the threshold of entries frequency. When the entries detected reaches or exceeds the threshold, an alarm is triggered.
Alarm Name	The name is Entries Frequency by default. You can change the name.

Step 4 Click Apply.

## 5.10 Alarm Settings

### 5.10.1 Alarm Information

#### Background Information

You can search for, view and back up the alarm information.

#### Procedure

Step 1 Select Main Menu > ALARM > Alarm Info.





Figure 5-168 Alarm status

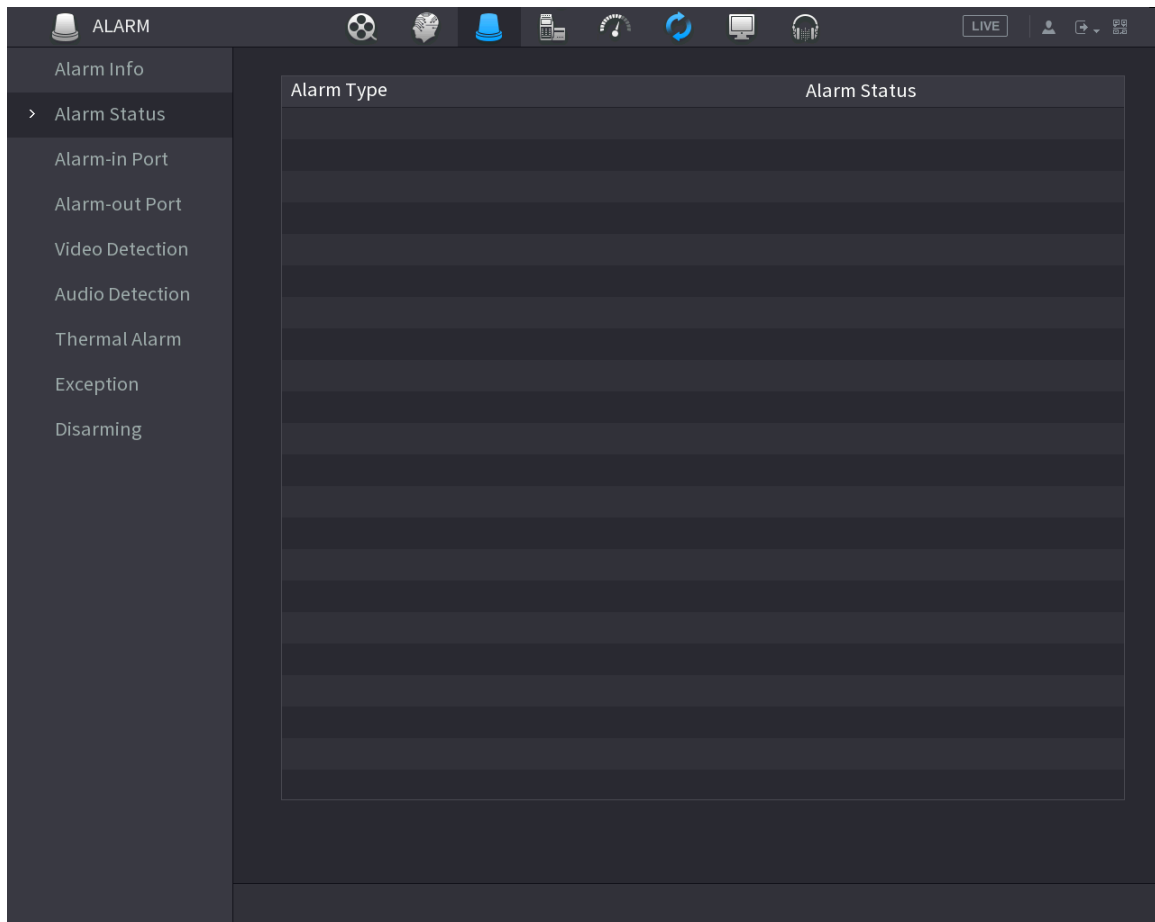

### 5.10.3 Alarm Input

#### Procedure

**Step 1** Select Main menu > ALARM > Alarm-in Port.

**Step 2** Click each tab to configure alarm input settings.

- Local alarm: After connect the alarm device to the NVR alarm input port, the system performs alarm linkage actions when there is an alarm signal from the alarm input port to the NVR.
- Alarm box: You can connect the alarm box to the RS-485 port of the Device. When the alarm is detected by the alarm box, the alarm information will be uploaded to the Device, and then the Device performs alarm linkage actions.
- Network alarm: NVR performs alarm linkage actions when it receives the alarm signal via the network transmission.
- IPC external alarm: When the peripheral device connected to the camera has triggered an alarm, the camera uploads the alarm signal to the NVR via the network transmission. The system performs the corresponding alarm linkage actions.
- IPC offline alarm: When the network connection between the NVR and the network camera is off, the system performs alarm linkage actions.

Figure 5-169 Local alarm

Local	Alarm Box	Network	CAM Ext	CAM Offline
Alarm-in Port	1	Alarm Name	Alarm-in Port1	
Enable	<input checked="" type="checkbox"/>	Device Type	NO	
Schedule	Setting	Anti-Dither	5	sec.
Alarm-out Port	Setting	Post-Alarm	10	sec.
<input type="checkbox"/> Show Message	<input type="checkbox"/> Report Alarm	<input type="checkbox"/> Send Email		
<input type="checkbox"/> Record Channel	Setting	Post-Record	10	sec.
<input type="checkbox"/> PTZ Linkage	Setting	<input type="checkbox"/> Picture Storage	Setting	
<input type="checkbox"/> Tour	Setting	<input type="checkbox"/> Buzzer	<input checked="" type="checkbox"/> Log	
<input type="checkbox"/> Alarm Tone	None	<input type="checkbox"/> Alarm Tone	None	
<input type="checkbox"/> Disarming				
Default	Copy to	Apply	Back	

**Step 3** Click Setting next to Schedule to configure the alarm schedule.

**Step 4** Configure the anti-dither period.

If multiple alarms occur during the anti-dither period, the system only record the event once.

**Step 5** Configure alarm linkage. For details, see Table 5-43.

**Step 6** Enable Disarming so that you can connect a switch to the alarm input port for disarming control.

**Step 7** Click Apply.

## 5.10.4 Alarm Output

### Background Information

You can set proper alarm output mode to auto, manual or off. After you connect the alarm device to the alarm output port of NVR, and set the mode to auto, the system performs alarm linkage actions when an alarm occurs.

- Auto: Once an alarm event occurs, the system generates an alarm.
- Manual: Alarm device is always on the alarming mode.
- Off: Disable alarm output function.

## Procedure

**Step 1** Select Main Menu > ALARM > Alarm-out Port.

Figure 5-170 Alarm-out port

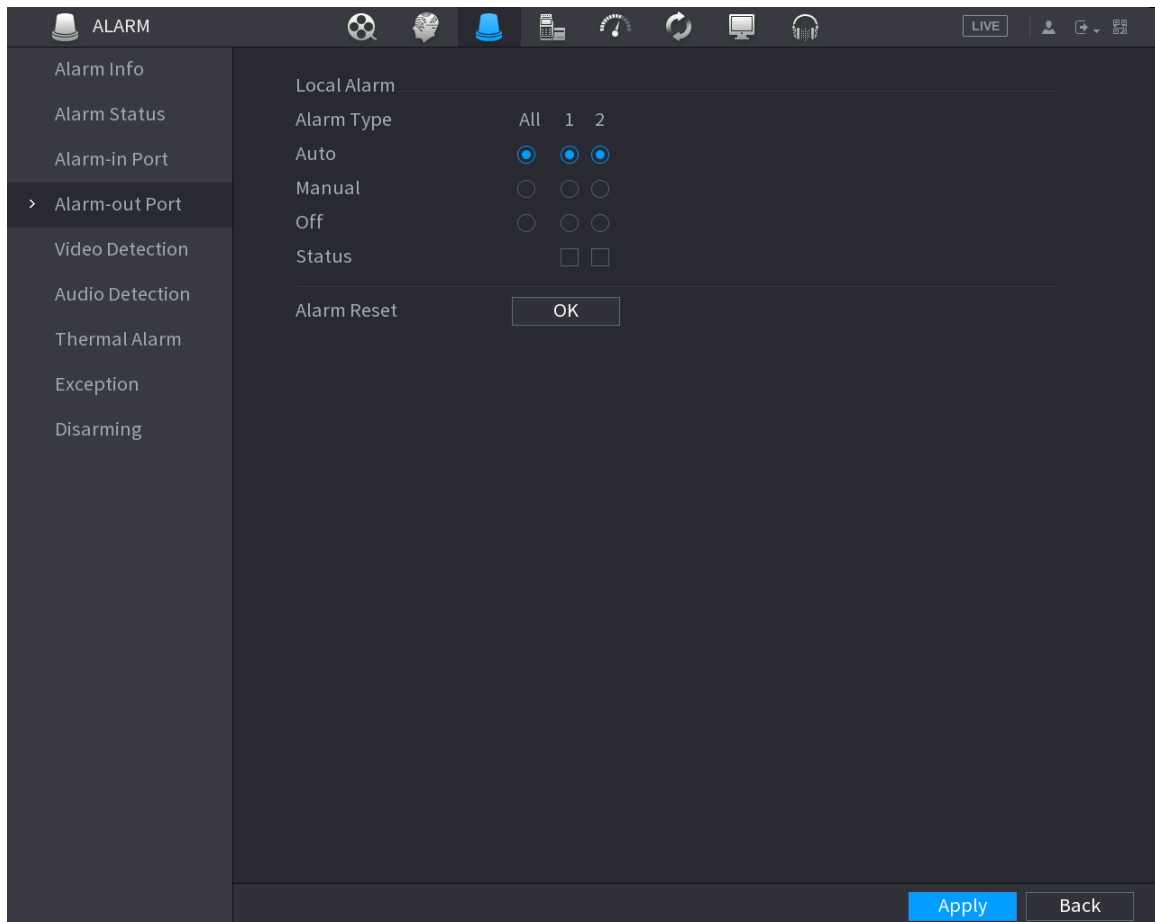

**Step 2** Select the alarm mode of the alarm output channel.

**Step 3** Click Apply.

- Click OK next to Alarm Reset to clear all alarm output statuses.
- View the alarm output status on the Status column.

## 5.10.5 Video Detection

The system can analyze the video and check whether there is considerable change or not. Once video has changed considerably (for example, there is any moving object, video is distorted), the system performs alarm linkage actions.

## 5.10.5.1 Motion Detection

### Background Information

When the moving object appears and moves fast enough to reach the preset sensitivity value, the system performs alarm linkage actions.

### Procedure

**Step 1** Select Main Menu > ALARM > Video Detection > Motion Detection.

**Step 2** Select a channel and then click  to enable the function.

**Step 3** Configure the detection region.

- 1) Click Setting next to Region.
- 2) Point to the middle top of the page.
- 3) Select one region, for example, click .
- 4) Drag on the screen to select the region that you want to detect.
- 5) Configure the parameters.

Table 5-48 Detection region parameters

Parameter	Description
Name	Enter a name for the region.
Sensitivity	Every region has an individual sensitivity value. The bigger the value is, the easier to trigger an alarm.
Threshold	Adjust the threshold for motion detection. Every region of every channel has an individual threshold.



You can configure up to four detection regions. When any one of the four regions activates motion detection alarm, the channel where this region belongs to will activate motion detection alarm.

- 6) Right-click the page to exit.

**Step 4** Click Setting next to Schedule to configure the alarm schedule.

**Step 5** Configure the anti-dither period.

If multiple alarms occur during the anti-dither period, the system only record the event once.

**Step 6** Configure alarm linkage. For details, see *Network Video Recorder\_User's Manual*.

This section uses associating siren as an example.

Enable Alarm Hub, select the alarm hub as needed, and then select siren as needed.**Step 7**

Click Apply.

## 5.10.5.2 Video Loss

### Background Information

When the video loss occurs, the system performs alarm linkage actions.

## Procedure

**Step 1** Select Main Menu > ALARM > Video Detection > Video Loss.

Figure 5-171 Video Loss

**Step 2** Select a channel and then click  to enable the function.

**Step 3** Click Setting next to Schedule to configure the alarm schedule.

**Step 4** Configure alarm linkage. For details, see *Network Video Recorder\_User's Manual*.

**Step 5** Click Apply.

### 5.10.5.3 Video Tampering

#### Background Information

When the camera lens is covered, or the video is displayed in a single color because of sunlight status, the monitoring cannot be continued normally. To avoid such situations, you can configure the tampering alarm settings.

#### Procedure

**Step 1** Select Main Menu > ALARM > Video Detection > Video Tampering.

Figure 5-172 Video tampering

Motion Detection	Video Loss	Video Tampering	Scene Changing	PIR
Channel	D1			
Enable	<input type="checkbox"/>			
Schedule	Setting			
Alarm-out Port	Setting	Post-Alarm	0 sec.	
<input type="checkbox"/> Show Message	<input type="checkbox"/> Report Alarm	<input type="checkbox"/> Send Email		
<input type="checkbox"/> Record Channel	Setting	Post-Record	10 sec.	
<input type="checkbox"/> PTZ Linkage	Setting			
<input type="checkbox"/> Tour	Setting	<input type="checkbox"/> Picture Storage		
<input type="checkbox"/> Buzzer	<input type="checkbox"/> Log			
<input type="checkbox"/> Alarm Tone	None			
Default	Copy to	Refresh	Apply	Back

**Step 2** Select a channel and then click  to enable the function.

**Step 3** Click Setting next to Schedule to configure the alarm schedule.

**Step 4** Configure alarm linkage. For details, see *Network Video Recorder\_User's Manual*.

**Step 5** Click Apply.

#### 5.10.5.4 Scene Change

##### Background Information

When the detected scene has changed, system performs alarm linkage actions.

##### Procedure

**Step 1** Select Main Menu > ALARM > Video Detection > Scene Changing.

Figure 5-173 Scene changing

**Step 2** Select a channel and then click  to enable the function.

**Step 3** Click Setting next to Schedule to configure the alarm schedule.

**Step 4** Configure alarm linkage. For details, see *Network Video Recorder\_User's Manual*.

**Step 5** Click Apply.

### 5.10.5.5 PIR Alarm

#### Background Information

PIR function helps enhancing the accuracy and validity of motion detect. It can filter the meaningless alarms that are activated by the objects such as falling leaves and flies. The detection range by PIR is smaller than the field angle.

PIR function is enabled by default if it is supported by the cameras. Enabling PIR function will get the motion detection to be enabled automatically to generate motion detection alarms.

#### Procedure

**Step 1** Select Main Menu > ALARM > Video Detection > PIR.



Figure 5-174 PIR

**Step 2** Select a channel and then click  to enable the function.

**Step 3** Configure the detection region.

- 1) Click Setting next to Region.
- 2) Point to the middle top of the page.
- 3) Select one region, for example, click .
- 4) Drag on the screen to select the region that you want to detect.
- 5) Configure the parameters.

Table 5-49 Detection region parameters

Parameter	Description
Name	Enter a name for the region.
Sensitivity	Every region of every channel has an individual sensitivity value. The bigger the value is, the easier to trigger an alarm.
Threshold	Adjust the threshold for motion detection. Every region of every channel has an individual threshold.



You can configure up to four detection regions. When any one of the four regions activates an alarm, the channel where this region belongs to will activate an alarm.

6) Right-click to exit the page.

**Step 4** Click Setting next to Schedule to configure the alarm schedule.

**Step 5** Configure the anti-dither period.

If multiple alarms occur during the anti-dither period, the system only record the event once.

**Step 6** Configure alarm linkage. For details, see *Network Video Recorder\_User's Manual*.

**Step 7** Click Apply.

## 5.10.6 Audio Detection

### Background Information

The system can generate an alarm once it detects the audio is not clear, the tone color has changed or there is abnormal or audio volume change.

### Procedure

**Step 1** Select Main Menu > ALARM > Audio Detection.

**Step 2** Select a channel and then click  to enable detection of audio exception and intensity change.

- Audio Exception: The system generates an alarm when the audio input is abnormal.
- Intensity Change: Set the sensitivity and threshold. An alarm is triggered when the change in sound intensity exceeds the defined threshold.

**Step 3** Click Setting next to Schedule to configure the alarm schedule.

**Step 4** Configure alarm linkage. For details, see Table 5-43.

**Step 5** Click Apply.

## 5.10.7 Thermal Alarm

### Background Information

After receiving the alarm signal from the connected thermal devices, the system can recognize the alarm type, and then trigger the corresponding alarm actions.

The system supports heat alarm, temperature (temperature difference) and cold/hot alarm.

- Heat alarm: The system generates an alarm once it detects there is a fire.
- Temperature (temperature difference): The system triggers an alarm once the temperature difference between two positions is higher or below the specified threshold.
- Cold/hot alarm: The system triggers an alarm once the detected position temperature is

higher or below the specified threshold.



- Make sure that the connected camera supports temperature monitoring function.
- This function is available on select models.
- The thermal detection functions might vary depending on the connected camera. This section uses heat alarm as an example.

## Procedure

**Step 1** Select Main Menu > ALARM > Thermal Alarm.

Figure 5-175 Thermal alarm

**Step 2** Select a channel and set alarm type to heat alarm, and then enable the function.

**Step 3** Select fire mode. The system supports preset mode and zone excluded mode.

- Preset mode: Select a preset and then enable the function. The system generates an alarm once it detects there is a fire.
- Zone excluded mode: The system filters the specified high temperature zone. The system generates an alarm once the rest zone has fire.

**Step 4** Configure alarm linkage. For details, see Table 5-43.

**Step 5** Click Apply.

## 5.10.8 Exception

### Background Information

When an error in HDD, network, and device occurs, the system performs alarm linkage

actions.

## Procedure

**Step 1** Select Main Menu > ALARM > Exception.

Figure 5-176 Disk exception

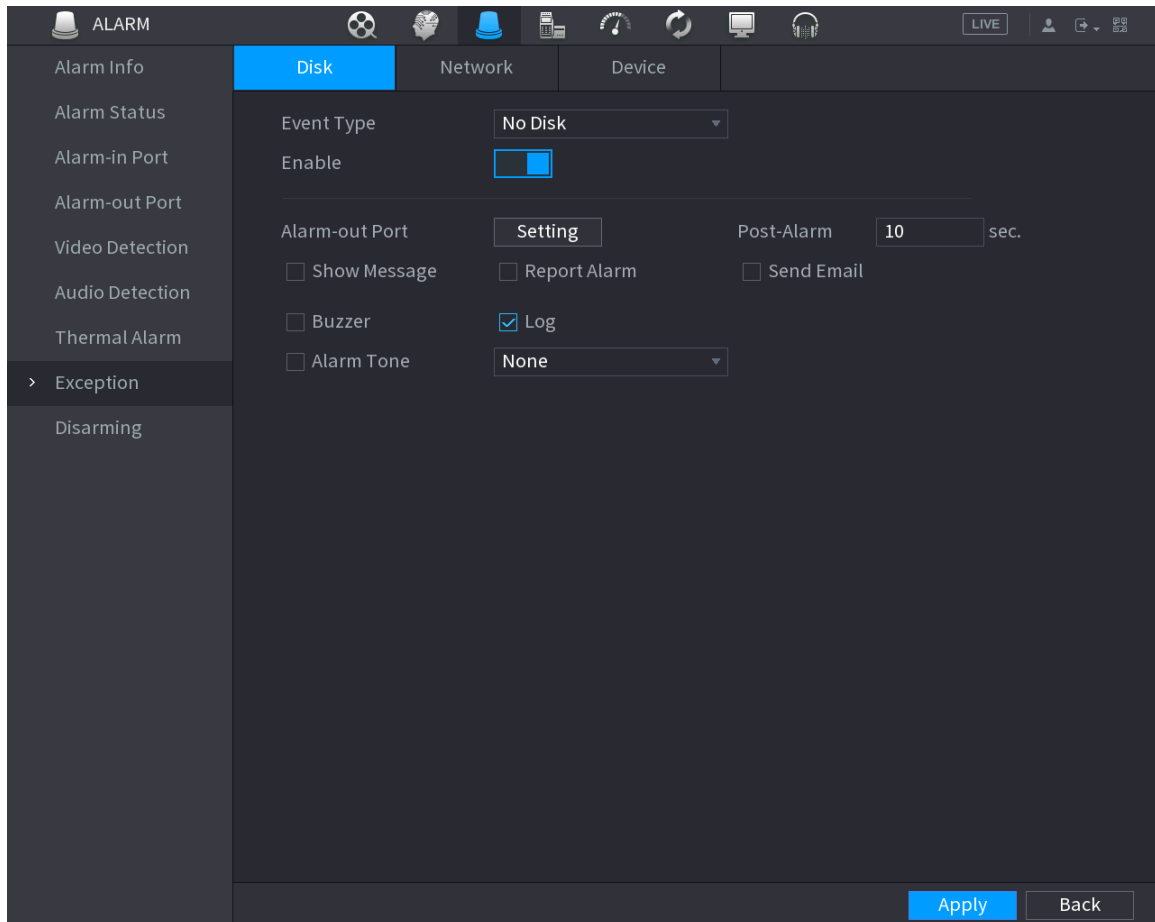

**Step 2** Click each tab and then select an event type.

- **Disk:** The system detects HDD error, no HDD, no space, and other HDD events.
- **Network:** The system detects network errors such as disconnection, IP conflict, and MAC conflict.
- **Device:** The system detects device errors such as abnormal fan speed and network security error.

**Step 3** Click  to enable the function.

**Step 4** (Optional) If the event type is Low Space, you need to configure the threshold of storage space.

When the storage space is lower than the threshold, an alarm is triggered.

**Step 5** Configure alarm linkage. For details, see Table 5-43.

**Step 6** Click Apply.

## 5.10.9 Disarming

You can disarm all alarm linkage actions as needed through one click.

### Procedure

- Step 1** Select Main Menu > ALARM > Disarming.
- Step 2** Select On for Disarming to enable disarming.

Figure 5-177 Disarming

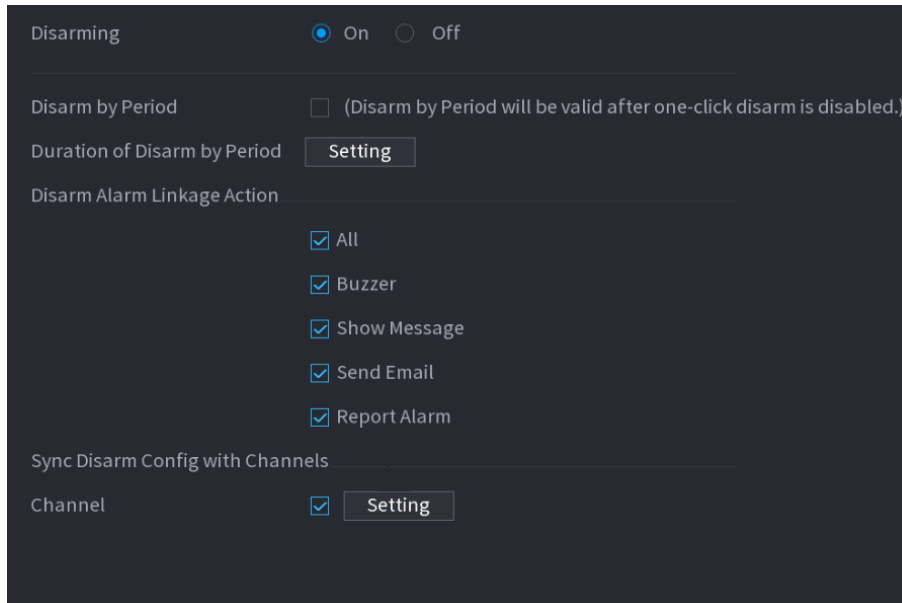

- Step 3** (Optional) To enable scheduled disarming, click Setting next to Duration of Disarm by Period, and then set periods.



Scheduled disarming is only effective when Disarming is Off.

Figure 5-178 Scheduled disarming

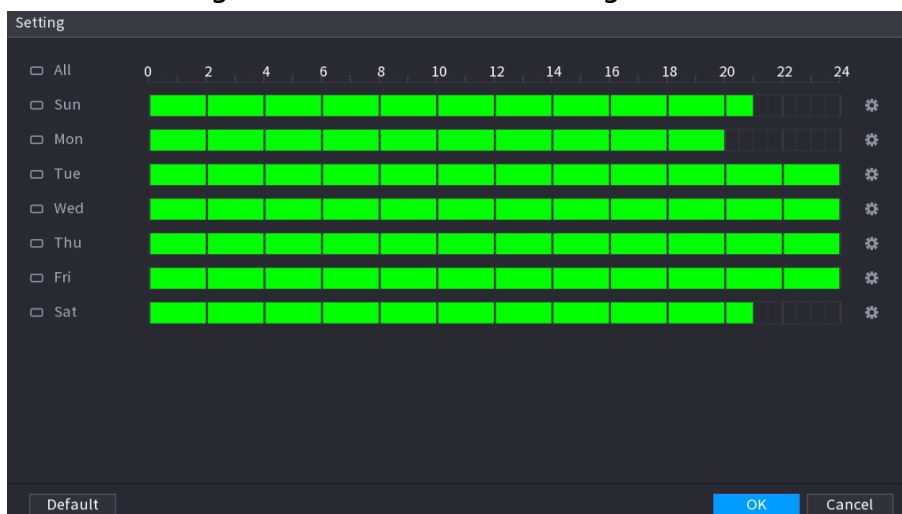



- Drag your mouse to select time blocks.
- Green blocks indicates that disarming is enabled.
- You can also click  to set time periods. One day can have 6 periods at most.

**Step 4** Select the alarm linkage actions to disarm.



All alarm linkage actions will be disarmed if you select All.

**Step 5** To disarm remote channels, select the checkbox at Channel, and then click Setting to select channels.



This function is only effective when the connected camera supports one-click disarming.

**Step 6** Click Apply.

## 5.11 Network

Configure the network settings to ensure the Device can communicate with other devices on the same LAN.

### 5.11.1 TCP/IP

#### Background Information

You can configure the settings for the Device such as IP address, DNS according to the networking plan.

#### Procedure

**Step 1** Select Main Menu > NETWORK > TCP/IP.

Figure 5-179 TCP/IP

NIC Name	IP Address	Network ...	NIC Member	Modify	Unbind
NIC1	192.168.1.1	Single NIC	1		

IP Address: 192.168.1.1      Default Gateway: 192.168.1.1      MTU: 1500  
MAC Address: 08:00:27:00:00:00      Subnet Mask: 255.255.255.0      Mode: Static

IP Version:        DHCP  
Preferred DNS:   
Alternate DNS:   
Default Card:

Virtual Host:





**Step 2** Click  to configure the NIC card, and then click OK.

Figure 5-180 TCP/IP

Table 5-50 TCP/IP parameters

Parameter	Description
Network Mode	<ul style="list-style-type: none"> <li>• <b>Single NIC:</b> The current NIC card works independently. If the current NIC card is disconnected, the Device becomes offline.</li> <li>• <b>Fault Tolerance:</b> Two NIC cards share one IP address. Normally only one NIC card is working. When this card fails, the other NIC card will start working automatically to ensure the network connection. The Device is regarded as offline only when both NIC cards are disconnected.</li> <li>• <b>Load Balance:</b> Two NIC cards share one IP address and work at the same time to share the network load averagely. When one NIC card fails, the other card continues to work normally. The Device is regarded as offline only when both NIC cards are disconnected.</li> </ul> <p> The Device with single Ethernet port does not support this function.</p>



Parameter	Description
NIC Member	<p>When the network mode is Fault Tolerance or Load Balance, you need to select the checkbox to bind NIC cards.</p>  <ul style="list-style-type: none"> <li>• Make sure that at least two NIC cards are installed.</li> <li>• NIC cards using different ports such as optical port and electrical port cannot be bound together.</li> <li>• After binding NIC cards, you need to restart the Device to make the change effective.</li> </ul>
IP Version	Select IPv4 or IPv6. Both versions are supported for access.
MAC Address	Displays the MAC address of the Device.
DHCP	<p>Enable the system to allocate a dynamic IP address to the Device. There is no need to set IP address manually.</p>  <ul style="list-style-type: none"> <li>• If you want to manually configure the IP information, disable the DHCP function first.</li> <li>• If PPPoE connection is successful, the IP address, subnet mask, default gateway, and DHCP are not available for configuration.</li> </ul>
IP Address	<p>Enter the IP address and configure the corresponding subnet mask and default gateway.</p>  <ul style="list-style-type: none"> <li>• The IP address and default gateway must be on the same network segment.</li> <li>• Click Test to check whether the IP address is available.</li> </ul>
Subnet Mask	
Default Gateway	
MTU	Displays the MTU value of the NIC card.

**Step 3** On the TCP/IP page, configure the DNS server.



This step is compulsive if you want to use the domain service.

- Obtain DNS server automatically.  
When there is DHCP server on the network, you can enable DHCP so that the Device can automatically obtain a dynamic IP address.
- Configure DNS server manually.  
Select the IP version, and then enter the IP addresses of preferred and alternate DNS server.

**Step 4** Select a NIC card as the default card.

**Step 5** Click Apply.

## 5.11.2 Routing Table

### Background Information

You can configure the routing table so that the system can automatically calculate the best path for data transmission.

### Procedure

**Step 1** Select Main Menu > NETWORK > TCP/IP > Routing Table.

Figure 5-181 Routing table

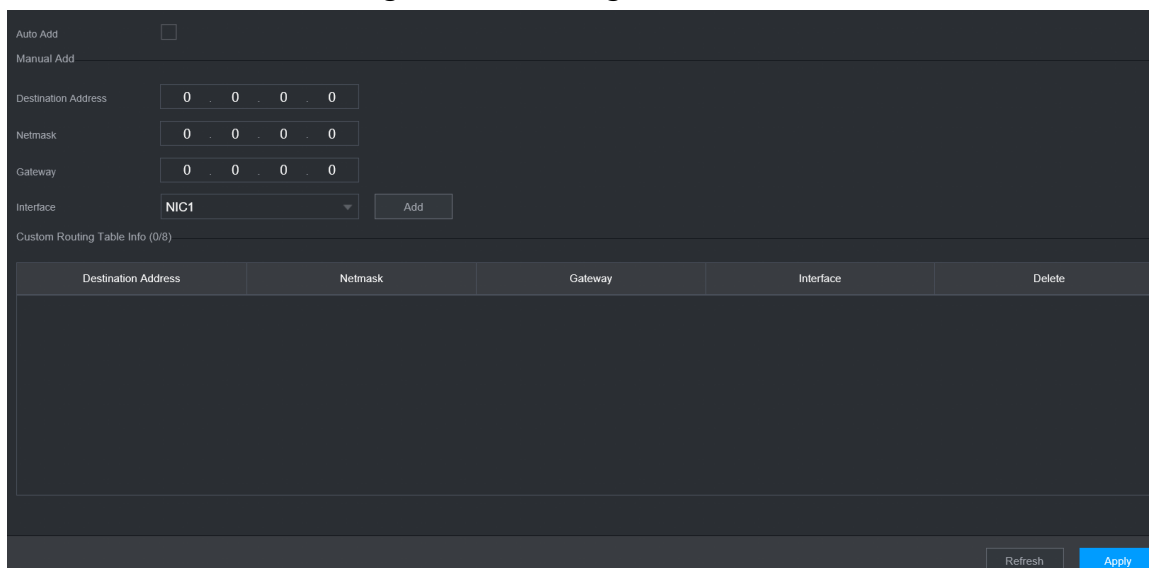

**Step 2** Add the routing table.

- Auto add.  
When you add a camera to the NVR and the IP address of the camera is not on the existing routing table, the system will add the routing information.
- Manual add.  
Configure the parameters such as destination address, netmask, and gateway, and then click Add.



- ◇ The destination address and netmask must not be on the same LAN.
- ◇ The netmask must be valid and on the same LAN with the NIC card.
- ◇ You can configure up to eight pieces of routing information.

**Step 3** Click Apply.

## 5.11.3 Port

### Background Information

You can configure the maximum connection for accessing the Device from web, platform, mobile phone or other clients at the same time, and configure each port number.

## Procedure

**Step 1** Select Main Menu > NETWORK > Port.

Figure 5-182 Port

Max Connection	128	(0-128)
TCP Port	37777	(1025-65535)
UDP Port	37778	(1025-65535)
HTTP Port	80	(1-65535)
HTTPS Port	443	(1-65535)
RTSP Port	554	(1-65535)
NTP Server Port	123	(1-65535)
POS Port	38800	(1025-65535)
RTSP Format	rtsp://<Username>:<Password>@<IP Address>:<Port>/cam/realmonitor?channel=1&subtype=0 channel: Channel, 1-24; subtype: Stream Type, Main Stream 0, Sub Stream 1.	

**Step 2** Configure the parameters.



The parameters except Max Connection take effect after the Device restarts.

Table 5-51 Port parameters

Parameter	Description
Max Connection	The allowable maximum clients accessing the Device at the same time, such as web client, platform, and mobile client.
TCP Port	Transmission control protocol port. Enter the value according to your actual situation.
UDP Port	User datagram protocol port. Enter the value according to your actual situation.
HTTP Port	The default value setting is 80. You can enter the value according to your actual situation. If you change the HTTP port number to, for example, 70, then you need to enter 70 after the IP address when logging in to the Device through the browser.
HTTPS Port	HTTPS communication port. The default value is 443. You can enter the value according to your actual situation.
RTSP Port	The default value is 554. You can enter the value according to your actual situation.
POS Port	POS data transmission port. The value range from 1 through 65535. The default value is 38800.

**Step 3** Click Apply.

## 5.11.4 External Wi-Fi

The Device can be connected to wireless network with an external Wi-Fi module.

### Prerequisites

Make sure that external Wi-Fi module is installed on the Device.

### Background Information



This function is available on select models.

### Procedure

**Step 1** Select Main Menu > NETWORK > Wi-Fi.

Figure 5-183 Wi-Fi

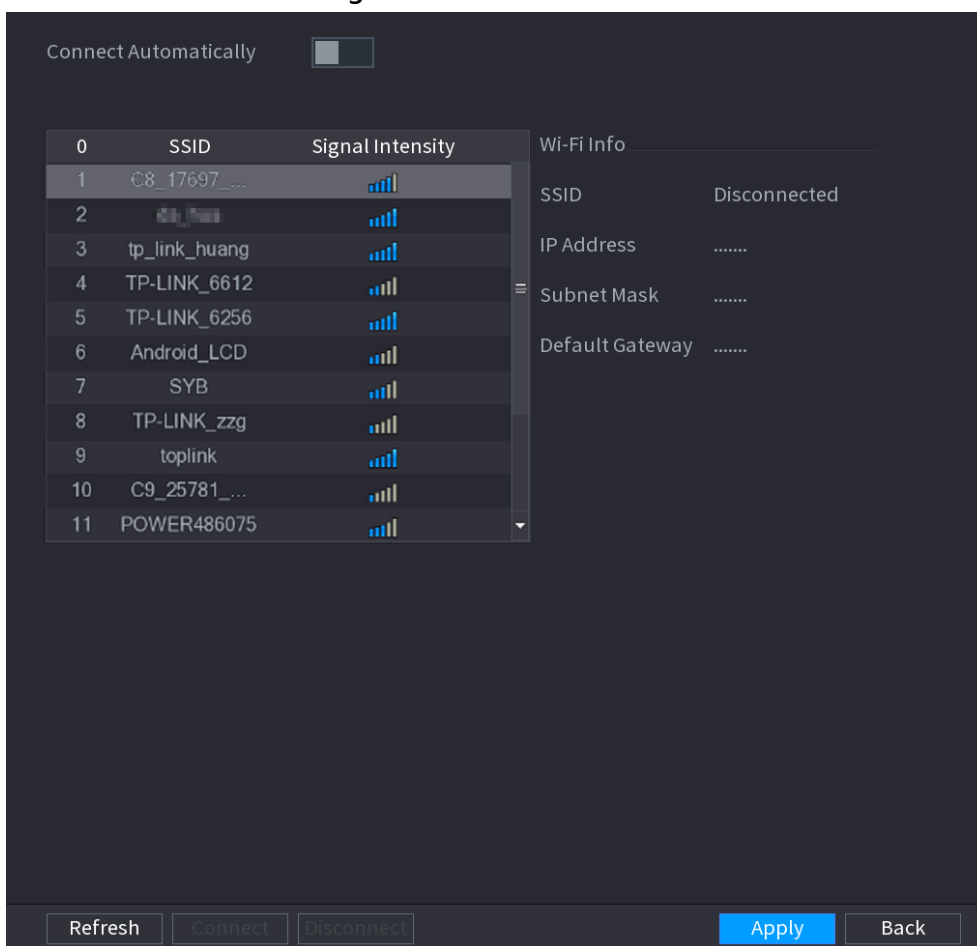

**Step 2** Configure the parameters.

Table 5-52 Wi-Fi parameters

Parameter	Description
Connect Automatically	After the function is enabled, the NVR will connect to the nearest site that was previously successfully connected after the Device starts.

Parameter	Description
Refresh	Search for the sites again.
Disconnect	Disconnect the current connection.
Connect	Select an available site and then click Connect.

**Step 3** Click Apply.



- After the connection is successful, a Wi-Fi connection signal flag appears in the upper-right corner of the live view page.
- The Wi-Fi module models currently supported are D-LINK, dongle and EW-7811UTC wireless cards.

## 5.11.5 Wi-Fi AP

### Background Information

You can configure Wi-Fi parameters for the NVR to ensure that a wireless IPC can connect to the NVR through Wi-Fi AP.



This function requires the built-in Wi-Fi module in the Device.

#### 5.11.5.1 General Settings

### Background Information

You can configure SSID, encryption type, password and channel of the device.



- This function is supported on select wireless models.
- When the wireless IPC and NVR are matched, the pairing will be completed in 120 seconds after they are powered on.

### Procedure

**Step 1** Select Main Menu > NETWORK > Wi-Fi AP > General.

Figure 5-184 General settings

Parameter	Value
Wi-Fi	<input checked="" type="checkbox"/>
SSID	DAP-H6TG4...
Hide SSID	<input type="checkbox"/>
Encryption Type	WPA2 PSK
Password	7954170d19...
Select Channel	6
Network Proxy	<input type="checkbox"/>

**Step 2** Select Wi-Fi to enable Wi-Fi.

**Step 3** Configure parameters.

Table 5-53 Parameters of general settings

Parameter	Description
SSID	Wi-Fi name for the device.
Hide SSID	Hide the Wi-Fi name.
Encryption Type	Select an encryption mode from WPA2 PSK and WPA PSK.
Password	Set the Wi-Fi password for the Device.
Select Channel	Select the channel for device communication.
Network Proxy	Enable the external network access through the Device for a wireless IPC.

**Step 4** Click Apply.

## 5.11.5.2 Advanced Settings

### Background Information



This function is supported on select wireless models.

You can configure IP address, subnet mask, default gateway, DHCP server of the Device.

### Procedure

**Step 1** Select Main Menu > NETWORK > Wi-Fi AP > Advanced.

Figure 5-185 Advanced settings

**Step 2** Configure parameters.

Table 5-54 Parameters of advanced settings

Parameter	Description
IP Address	Set IP address, subnet mask and default gateway for the Wi-Fi of NVR.
Subnet Mask	
Default Gateway	<p>IP address and default gateway must be on the same network segment.</p>
Start IP	Set the start IP address and end IP address of the DHCP server.

Parameter	Description
End IP	
Preferred DNS	Set preferred and alternate DNS server address.
Alternate DNS	

**Step 3** Click Apply.

## 5.11.8 Repeater

The Device supports settings for the wireless repeater IPC to extend video transmission distance and range.

### Prerequisites

- The Device has the built-in Wi-Fi module.
- The IPC has wireless repeater module.

### Background Information



This function is available on select models.

### Procedure

- Step 1** Power on the NVR and wireless repeater IPC, and connect all IPCs to the NVR through Wi-Fi.
- Step 2** Select Main Menu > NETWORK > REPEATER.





- Green connection line represents the successful connection between channel and wireless IPC.
- Auto cascade: After selecting auto cascade, the IPC can cascade to NVR automatically.

Figure 5-190 Repeater



**Step 3** Select Manual Cascade.



You can use manual cascade when there are at least two IPCs on the network.

Figure 5-191 Manual cascade

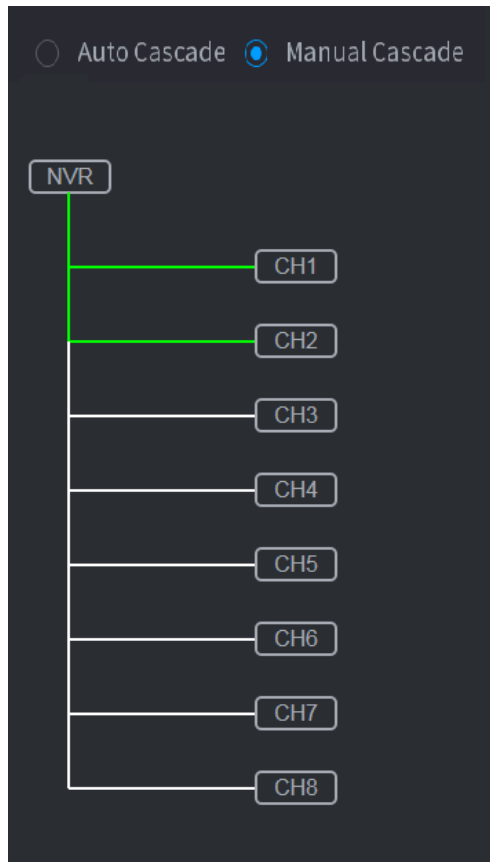

**Step 4** Click  and select the channel to be added.

Figure 5-192 Added channel

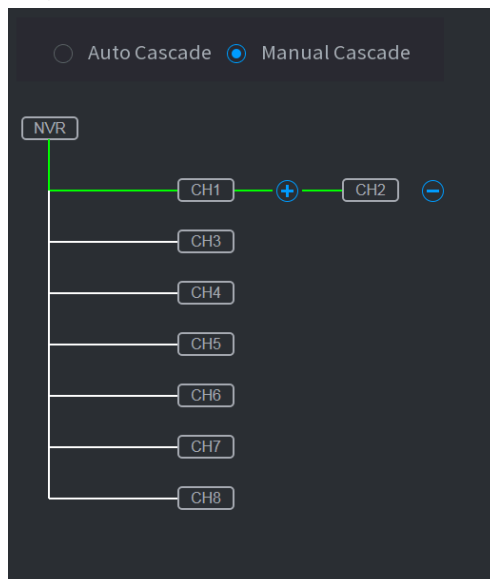

**Step 5** Click Apply.

## 5.11.9 PPPoE

PPPoE is another way for the Device to access the network. You can establish network connection by configuring PPPoE settings to give the Device a dynamic IP address on the WAN.

### Prerequisites

To use this function, firstly you need to obtain the username and password from the Internet Service Provider.

### Procedure

**Step 1** Select Main Menu > NETWORK > PPPoE.

Figure 5-193 PPPoE

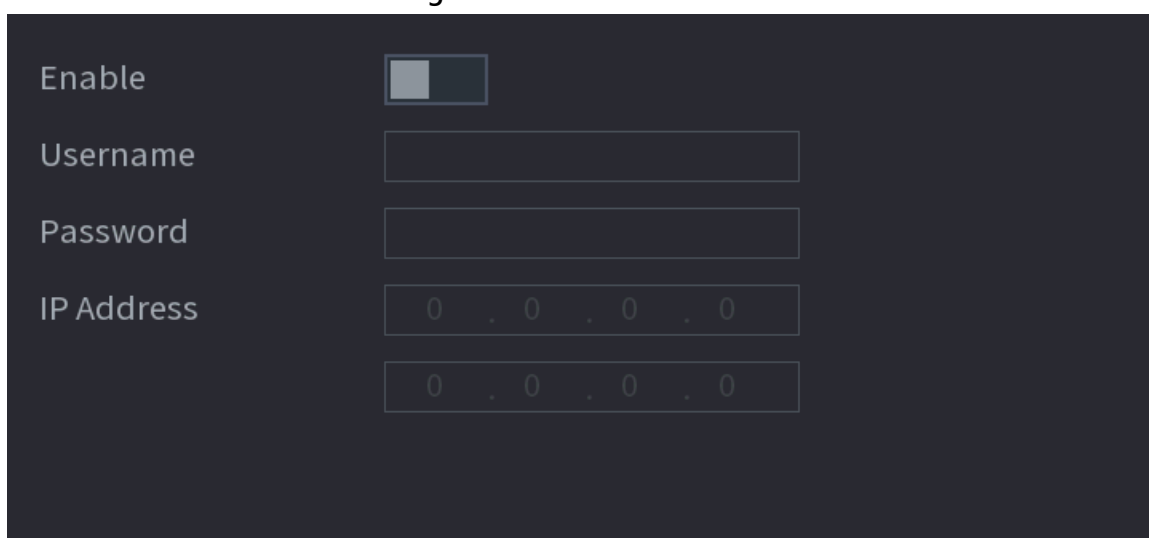

Enable	<input type="checkbox"/>
Username	<input type="text"/>
Password	<input type="text"/>
IP Address	<input type="text" value="0 . 0 . 0 . 0"/>
	<input type="text" value="0 . 0 . 0 . 0"/>

**Step 2** Enable the PPPoE function.

**Step 3** Enter the username and password provided by the Internet Service Provider.

**Step 4** Click Apply.

The IP address appears on the PPPoE page. You can use this IP address to access the Device.



When the PPPoE function is enabled, the IP address on the TCP/IP page cannot be modified.

### 5.11.10 DDNS

When the IP address of the Device changes frequently, the DDNS function can dynamically refresh the correspondence between the domain on DNS and the IP address. You can access the Device by using the domain.

#### Prerequisites

Check the type of DDNS that the Device supports and then log in to the website provided by the DDNS service provider to register domain and other information.



After registration, you can log in to the DDNS website to view the information of all the connected devices under the registered account.

#### Procedure

**Step 1** Select Main Menu > NETWORK > DDNS.

Figure 5-194 DDNS

**Step 2** Enable DDNS and then configure the parameters.



After you enable DDNS function, the third-party server might collect your device information.

Table 5-57 DDNS parameters

Parameter	Description
Type	Displays the type and address of DDNS service provider.

Parameter	Description
Server Address	<ul style="list-style-type: none"> <li>• For DynDNS DDNS, the default address is members.dyndns.org.</li> <li>• For NO-IP DDNS, the default address is dynupdate.no-ip.com.</li> <li>• For CN99 DDNS, the default address is members.3322.org.</li> </ul>
Domain Name	Enter the domain name that you have registered on the website of DDNS service provider.
Username	Enter the username and password obtained from DDNS service provider. You need to register the username, password and other information on the website of DDNS service provider.
Password	
Interval	Enter the interval at which you want to update the DDNS.

**Step 3** Click Apply.

Enter the domain name in the browser on your computer, and then press the Enter key. If the web interface of the Device is displayed, the configuration is successful. If not, the configuration failed.

## 5.11.11 UPnP

You can map the relationship between the LAN and the WAN to access the Device on the LAN through the IP address on the WAN.

### 5.11.11.1 Configuring Router

#### Procedure

**Step 1** Log in to the router to set the WAN port to enable the IP address to connect into the WAN.

**Step 2** Enable the UPnP function on the router.

**Step 3** Connect the Device with the LAN port on the router to connect into the LAN.

**Step 4** Select Main Menu > NETWORK > TCP/IP, configure the IP address into the router IP address range, or enable the DHCP function to obtain an IP address automatically.

### 5.11.11.2 Configuring UPnP

#### Procedure

**Step 1** Select Main Menu > NETWORK > UPnP.



Figure 5-195 UPnP

6	Service Name	Protocol	Internal...	Externa...	Modify
1	HTTP	TCP	80	80	
2	TCP	TCP	37777	37777	
3	UDP	UDP	37778	37778	
4	RTSP	UDP	554	554	
5	RTSP	TCP	554	554	
6	HTTPS	TCP	443	443	

**Step 2** Configure the settings for the UPnP parameters.

Table 5-58 UPnP parameters

Parameter	Description
Port Mapping	Enable the UPnP function.
Status	Indicates the status of UPnP function. <ul style="list-style-type: none"> <li>Offline: Failed.</li> <li>Online: Succeeded.</li> </ul>
LAN IP	Enter IP address of router on the LAN.  After mapping succeeded, the system obtains IP address automatically.
WAN IP	Enter IP address of router on the WAN.  After mapping succeeded, the system obtains IP address automatically.

Parameter	Description
Port Mapping List	<p>The settings on port mapping list correspond to the UPnP port mapping list on the router.</p> <ul style="list-style-type: none"> <li>• Service Name: Name of network server.</li> <li>• Protocol: Type of protocol.</li> <li>• Internal Port: Internal port that is mapped on the Device.</li> <li>• External Port: External port that is mapped on the router.</li> </ul> <p></p> <ul style="list-style-type: none"> <li>• To avoid the conflict, when setting the external port, try to use the ports from 1024 through 5000 and avoid popular ports from 1 through 255 and system ports from 256 through 1023.</li> <li>• When there are several devices on the LAN, properly arrange the ports mapping relations to avoid mapping to the same external port.</li> <li>• When establishing a mapping relationship, ensure the mapping ports are not occupied or limited.</li> <li>• The internal and external ports of TCP and UDP must be the same and cannot be modified.</li> <li>• Click  to modify the external port.</li> </ul>

**Step 3** Click Apply to complete the settings.

In the browser, enter `http://WAN IP: External IP port`. You can visit the Device on the LAN.

## 5.11.12 Email

### Background Information

You can configure the email settings to enable the system to send the email as a notification when an alarm event occurs.

### Procedure

**Step 1** Select Main Menu > NETWORK > Email.

Figure 5-196 Email



**Step 2** Click  to enable the function.

**Step 3** Configure the email parameters.

Table 5-59 Email parameters

Parameter	Description
SMTP Server	Enter the address of SMTP server of sender's email account.
Port	Enter the port of SMTP server. The default value is 25.
Username	Enter the username and password of sender's email account.
Password	
Anonymous	Enable anonymous login.
Receiver	Select the receiver to receive the notification. You can select up to three receivers.
Email Address	Enter the email address of mail receivers.
Sender	Enter the sender's email address. You can enter up to three senders separated by comma.
Subject	Enter the email subject. You can enter Chinese, English and numerals with the length limited to 64 characters.
Attachment	Enable the attachment function. When there is an alarm event, the system can attach snapshots as an attachment to the email.



Parameter	Description
Encryption Type	Select the encryption type from NONE, SSL, or TLS.  For SMTP server, the default encryption type is TLS.
Interval (Sec.)	Set the interval at which the system sends an email for the same type of alarm event to avoid excessive pileup of emails caused by frequent alarm events. The value ranges from 0 to 3600. 0 means that there is no interval.
Health Mail	Enable the health test function. The system can send a test email to check the connection.
Sending Interval	Set the interval at which the system sends a health test email. The value ranges from 30 to 1440. 0 means that there is no interval.
Test	Click Test to test the email sending function. If the configuration is correct, the receiver's email account will receive the email.  Before testing, click Apply to save the settings.

Step 4 Click Apply.

### 5.11.13 SNMP

You can connect the Device with some software such as MIB Builder and MG-SOFT MIB Browser to manage and control the Device from the software.

#### Prerequisites

- Install the software that can manage and control the SNMP, such as MIB Builder and MG-SOFT MIB Browser
- Obtain the MIB files that correspond to the current version from the technical support.



This function is available on select models.

#### Procedure

Step 1 Select Main Menu > NETWORK > SNMP.

Figure 5-197 SNMP

The screenshot shows the SNMP configuration page. On the left is a navigation menu with options like TCP/IP, Port, Wi-Fi, 3G/4G, PPPoE, DDNS, UPnP, Email, > SNMP (selected), Multicast, Alarm Center, Register, Switch, and P2P. The main area contains the following settings:

- Enable:** A toggle switch that is currently turned off.
- Version:** Radio buttons for V1, V2, and V3 (Recommended). V3 is selected.
- SNMP Port:** A text input field containing '161' with a range '(1 - 65535)'.
- Read Community:** An empty text input field.
- Write Community:** An empty text input field.
- Trap Address:** An empty text input field.
- Trap Port:** A text input field containing '162' with a range '(1 - 65535)'.
- Read-Only Username:** A text input field containing 'Public'.
- Read/Write Username:** A text input field containing 'Private'.
- Authentication Type:** Two dropdown menus, both set to 'MD5'.
- Authentication Password:** Two empty text input fields.
- Encryption Type:** Two dropdown menus, both set to 'CBC-DES'.
- Encryption Password:** Two empty text input fields.

At the bottom right, there are 'Apply' and 'Back' buttons.

**Step 2** Click  to enable the function.

**Step 3** Configure the parameters.

Table 5-60 SNMP parameters

Parameter	Description
Version	Select the checkbox of SNMP version that you are using.  The default version is V3. There is a risk if you use V1 or V2.
SNMP Port	Enter the monitoring port on the agent program.
Read Community	Enter the read and write strings supported by the agent program.
Write Community	
Trap Address	Enter the destination address for the agent program to send the Trap information.
Trap Port	Enter the destination port for the agent program to send the Trap information.
Read-Only Username	Enter the username that is allowed to access the Device and has the read-only permission.
Read/Write Username	Enter the username that is allowed to access the Device and has the read and write permission.

Parameter	Description
Authentication Type	Select MD5 or SHA. The system recognizes the type automatically.
Authentication Password	Enter the password for authentication. The password should be no less than eight characters.
Encryption Type	Select an encryption type. The default setting is CBC-DES.
Encryption Password	Enter the encryption password.

**Step 4** Click Apply.

**Step 5** Compile the two MIB files by MIB Builder.

**Step 6** Run MG-SOFT MIB Browser to load in the module from compilation.

**Step 7** On the MG-SOFT MIB Browser, enter the device IP that you want to manage, and then select the version number to query.

**Step 8** On the MG-SOFT MIB Browser, unfold the tree-structured directory to obtain the configurations of the Device, such as the channels quantity and software version.

## 5.11.14 Multicast

### Background Information

When you access the Device from the network to view the video, if the access is exceeded, the video will not display. You can use the multicast function to group the IP to solve the problem.

### Procedure

**Step 1** Select Main Menu > NETWORK > Multicast.

Figure 5-198 Multicast

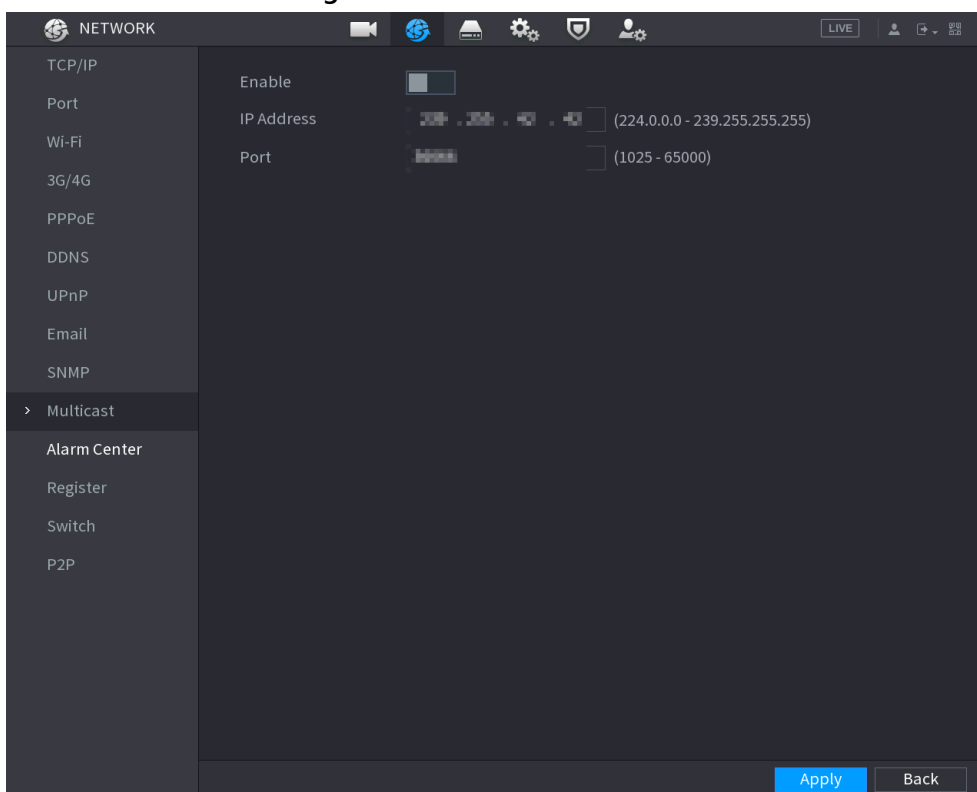

**Step 2** Configure the parameters.

Table 5-61 Multicast parameters

Parameter	Description
Enable	Enable the multicast function.
IP Address	Enter the IP address that you want to use as the multicast IP. The IP address ranges from 224.0.0.0 through 239.255.255.255.
Port	Enter the port for the multicast. The port ranges from 1025 through 65000.

**Step 3** Click Apply.

You can log in to the web interface via multicast.

On the web login page, on the Type list, select Multicast. The web will automatically obtain the multicast IP address and join the multicast group. Then you can view the video through multicast function.

## 5.11.15 Alarm Center

### Background Information

You can configure the alarm center server to receive the uploaded alarm information.

### Procedure

**Step 1** Select Main Menu > NETWORK > Alarm Center.

Figure 5-199 Alarm center

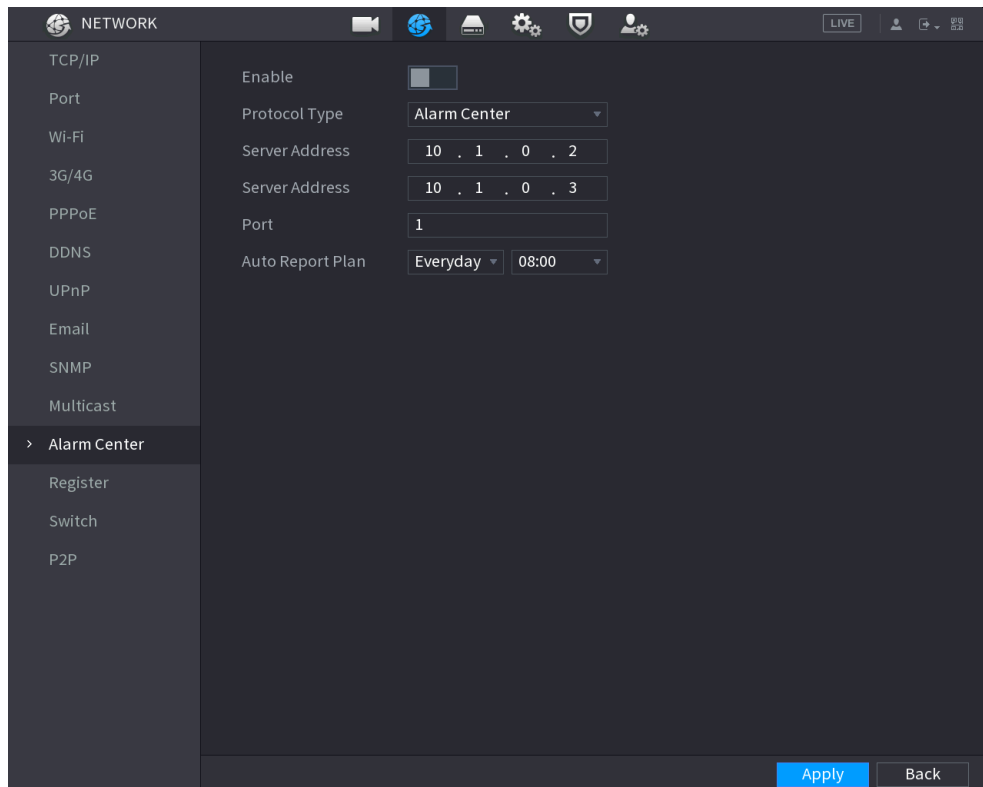

**Step 2** Click  to enable the function.

**Step 3** Configure the parameters.

Table 5-62 Alarm center parameters

Parameter	Description
Protocol Type	Select a protocol type.
Server Address	The IP address and communication port of the PC installed with alarm client.
Port	
Auto Report Plan	Select time cycle and specific time for uploading alarm.

**Step 4** Click Apply.

## 5.11.16 Register

You can register the Device into the specified proxy server which acts as the transit to enable the client software to access the Device

### Prerequisites

- The proxy server has been deployed.
- The Device, the proxy server and the device running the client software are on the same network.

### Procedure

**Step 1** Select Main Menu > NETWORK > Register.

Figure 5-200 Register

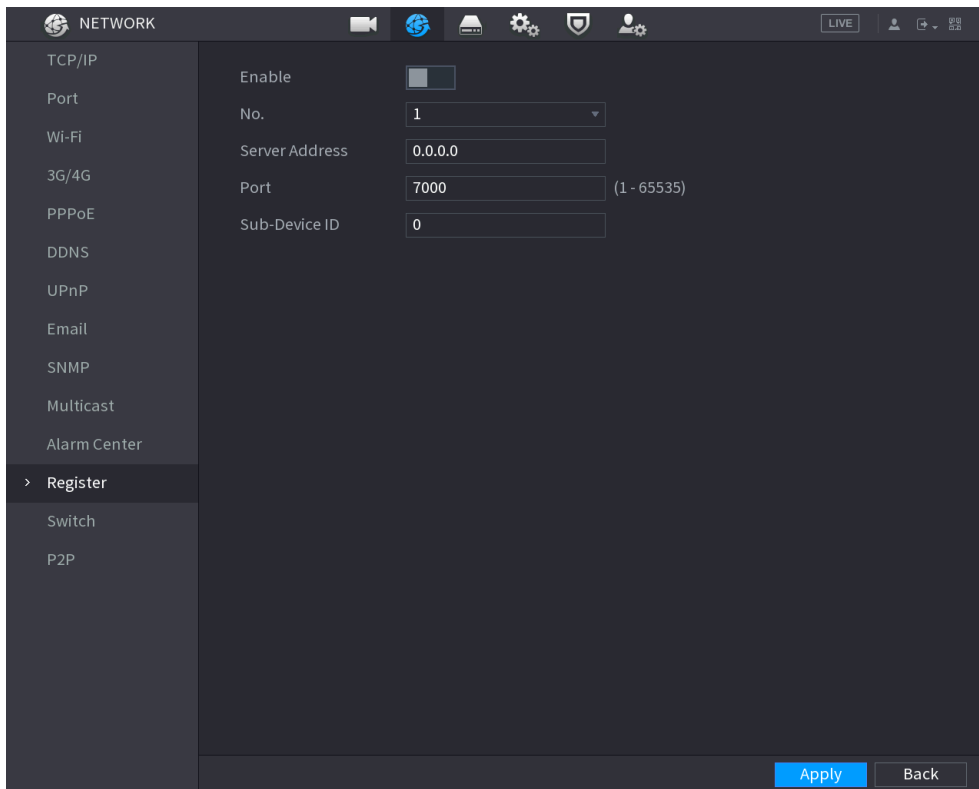

**Step 2** Click  to enable the function.

**Step 3** Configure the parameters.

Table 5-63 Register parameters

Function	Description
Server Address	Enter the IP address or domain name of the server that you want to register to.
Port	Enter the port of the server.
Sub-Device ID	Enter the ID allocated by the server.

**Step 4** Click Apply.

## 5.11.17 Switch

### Background Information

After setting Switch, when an IPC is connected to the PoE port, the system automatically assigns the IP address to the IPC according to the defined IP segment, and the NVR will automatically connect to the IPC.



- Only models with PoE ports support this function.
- Do not connect the PoE port with a switch, otherwise it will cause connection failure.
- This function is enabled by default, and the IP segment start from 10.1.1.1. We recommend you use the default setting.
- When connecting to a third-party IPC, make sure that the IPC supports ONVIF protocol and DHCP is enabled.

## Procedure

**Step 1** Select Main Menu > NETWORK > Switch.

Figure 5-201 Switch

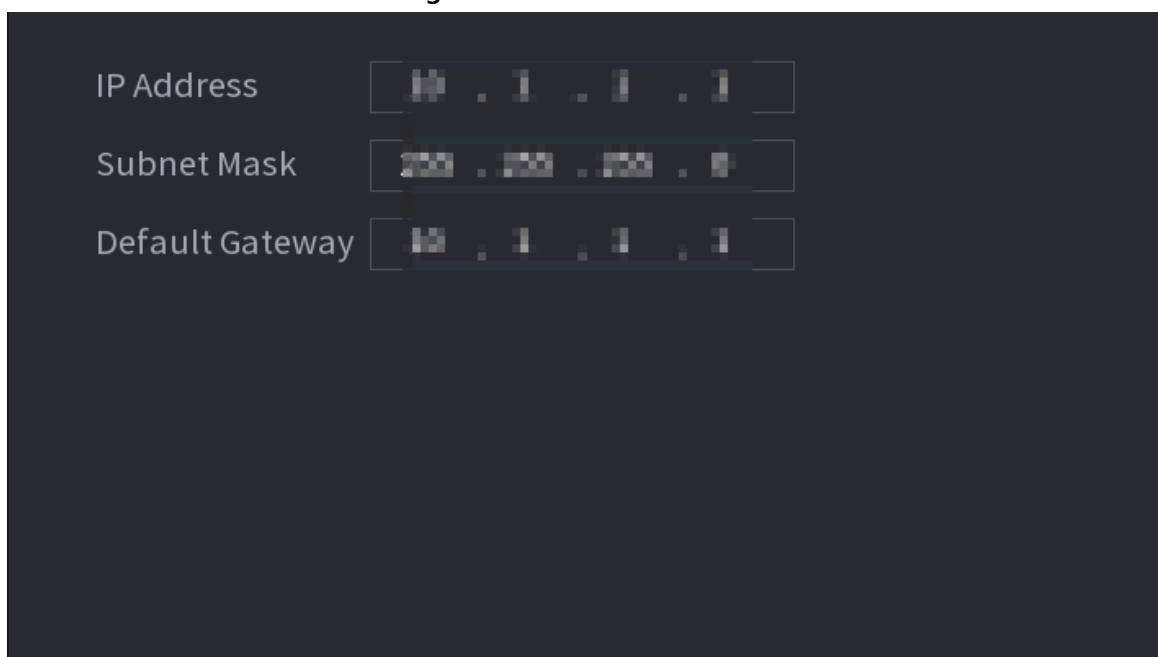

The screenshot shows a configuration interface with three input fields:

- IP Address: 10 . 1 . 1 . 1
- Subnet Mask: 255 . 255 . 255 . 0
- Default Gateway: 10 . 1 . 1 . 1

**Step 2** Configure IP address, subnet mask, and default gateway..



Do not set the IP address to the same network segment with the NVR. We recommend you use the default setting.

**Step 3** Click Apply.

## Related Operations



When connecting IP camera to PoE port, if all the channels are occupied, the system prompts you whether to take place of one channel.

Table 5-64 PoE operation

PoE operation	Description
Connect to PoE port	<p>When an IPC is connected to the PoE port, the system automatically assigns the IP address to the IPC according to the set IP segment. The NVR will try the method of arp ping to assign the IP address. If DHCP is enabled on the NVR, the NVR will use DHCP to assign the IP address.</p> <ul style="list-style-type: none"> <li>When IP address is successfully set, the system will broadcast through the switch function. If there is a response from the IPC, it means the connection is successful, and the NVR will log in to the IPC. You can find the corresponding channel occupied and there is a PoE icon at the upper-left corner.</li> <li>You can also view PoE status such as channel number and PoE port number on the Added Device list in Main Menu &gt; CAMERA &gt; Camera List.</li> </ul>
Disconnect PoE port	<p>When an IPC is disconnected from PoE port, you will find the information of Failed to find network host on the live channel window.</p>
PoE connection mapping	<p>The PoE ports are bound to corresponding channels. When an IPC is connected to PoE port 1, the corresponding channel is Channel 1.</p>

### 5.11.18 P2P

P2P is a kind of convenient private network penetration technology. Instead of applying for dynamic domain name, mapping ports or deploying transit server, you can add NVR devices to the app for remote management.

#### Procedure

Step 1 Select Main Menu > NETWORK > P2P.



Figure 5-202 P2P

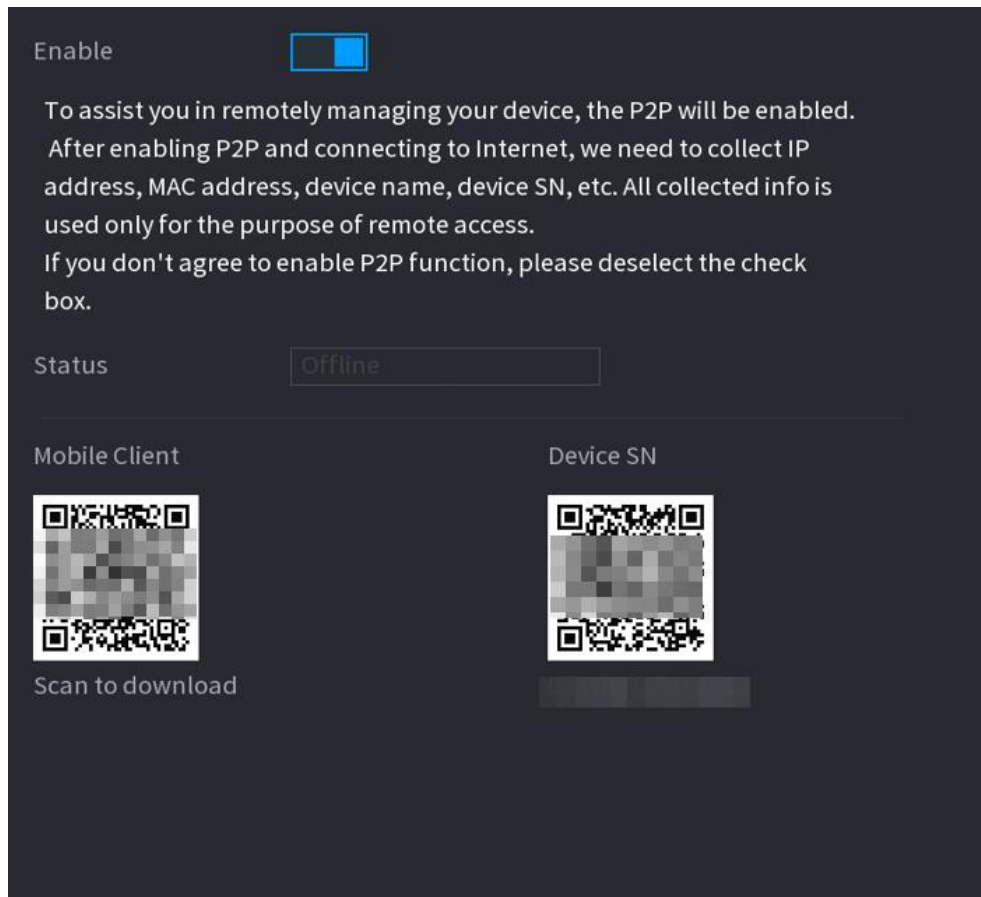

**Step 2** Enable the P2P function.



After you enable the P2P function and connect to the Internet, the system will collect the information such as email address and MAC address for remote access.

**Step 3** Click Apply.

The P2P function is enabled. You can use your phone to scan the QR code under Mobile Client to download and install the mobile client. After that, you can use the mobile client to scan the QR code under Device SN to add the Device for remote management. For details on the app operation, see the user's manual of the app.

## 5.12 Storage

You can manage the storage resources (such as record file) and storage space. So that it is easy for you to use and enhance storage space usage.

### 5.12.1 Basic

#### Background Information

You can set basic storage parameters.

## Procedure

**Step 1** Select Main Menu > STORAGE > Basic.

Figure 5-203 Basic storage

**Step 2** Set parameters.

Table 5-65 Basic storage parameters

Parameter	Description
Disk Full	Configure the storage strategy to be used when no more storage space is available <ul style="list-style-type: none"> <li>• Stop: Stop recording.</li> <li>• Overwrite: The newest files overwrite the oldest ones.</li> </ul>
Create Video Files	Configure the time length and file length for each recorded video.
Delete Expired Files	Configure whether to delete the old files. <ul style="list-style-type: none"> <li>• Select Auto and then configure how long you want to keep the old files.</li> <li>• Select Never if you do not want to use this function.</li> </ul>  Deleted files cannot be recovered.
Sleep Strategy	<ul style="list-style-type: none"> <li>• Auto: The system sleeps automatically after idling for a period of time.</li> <li>• Never: The system keeps running all the time.</li> </ul>

**Step 3** Click Apply.

## 5.12.2 Disk Manager

Select Main Menu > STORAGE > Disk Manager, and then you can set HDD properties and format HDD.

Figure 5-204 Disk manager

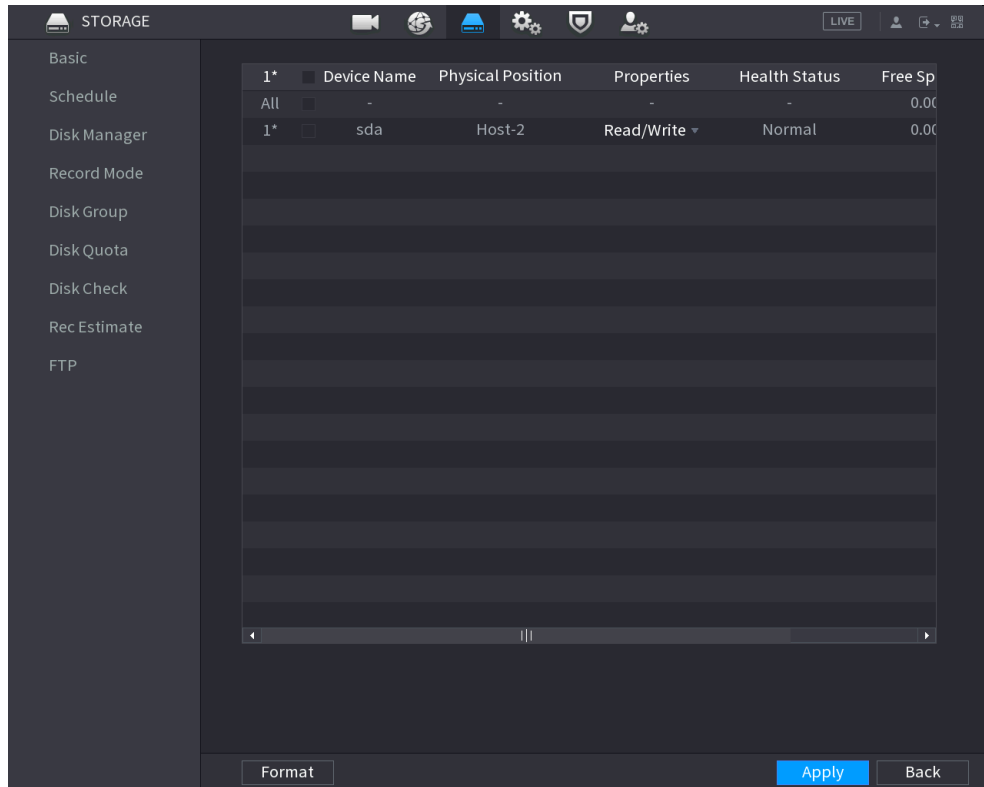

### View HDD Information

You can view the physical position, properties, status and storage capacity of each HDD.

### Configure HDD Properties

In the Properties column, you can set read and write, read-only and redundant HDD.



When there are two or more HDDs installed on the Device, you can set one HDD as redundant disk to back up recorded files.

### Format HDD

Select an HDD, click Format, and then follow the on-screen prompts to format the HDD.



- Formatting will erase all data in the HDD, proceed with caution.
- You can select whether to erase the HDD database. If the HDD database is erased, the Analytics+ search data and the uploaded audio files will be deleted.

## 5.12.3 RAnalytics+D

RAnalytics+D (redundant array of independent disks) is a data storage virtualization technology that combines multiple physical HDD components into a single logical unit for the purposes of data redundancy, performance improvement, or both.



RAanalytics+D function is available on select models.

Table 5-66 Disk quantity for different RAanalytics+D types

RAanalytics+D type	Required disk quantity
RAanalytics+D 0	At least 2.
RAanalytics+D 1	Only 2.
RAanalytics+D 5	At least 3. We recommend using 4 disks to 6 disks.
RAanalytics+D 6	At least 4.
RAanalytics+D 10	

### 5.12.3.1 Creating RAanalytics+D

RAanalytics+D has different levels, such as RAanalytics+D 5 and RAanalytics+D 6. Each level has different data protection, data availability, and performance grade. You can create different types of RAanalytics+D as needed.

#### Background Information



When you create RAanalytics+D, the disks in the RAanalytics+D group will be formatted. Back up data in time.

You can create different types of RAanalytics+D as needed.

#### Procedure

**Step 1** Select Main Menu > STORAGE > RAanalytics+D > RAanalytics+D.

Figure 5-205 RAnalytics+D

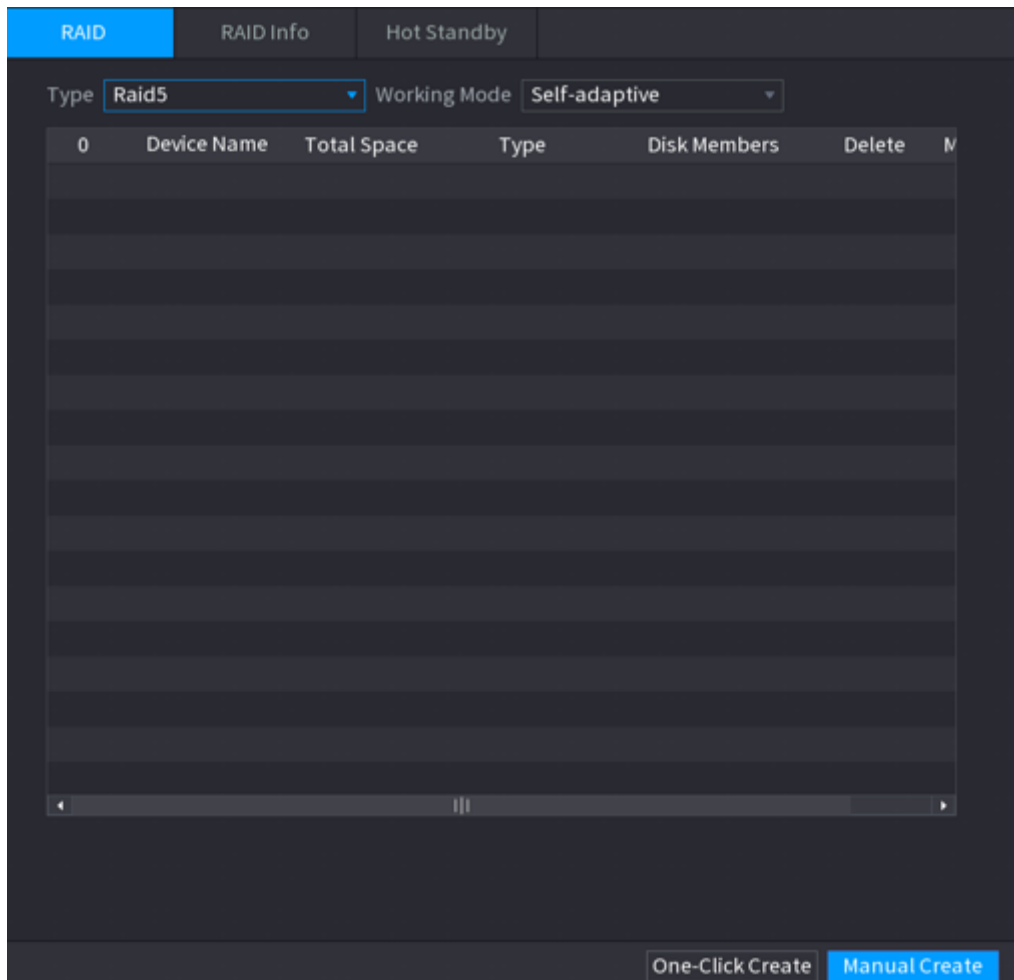

**Step 2** Select RAnalytics+D type and working mode.

The working mode determines how the system allocate resources.

- Self-Adaptive: Automatically adjust the RAnalytics+D synchronization speed according to the business status.
  - ◇ When there is no business running, synchronization is performed at a high speed.
  - ◇ When there is business running, synchronization is performed at a low speed.
- Sync First: Resource priority is assigned to RAnalytics+D synchronization.
- Business First: Resource priority is assigned to business operations.
- Balance: Resource is evenly distributed to RAnalytics+D synchronization and business operations.

**Step 3** Create RAnalytics+D.

- Automatic creation.
  - Select disks, and then click Create RAnalytics+D. The system will create RAnalytics+D 5 automatically.



Automatic creation of RAnalytics+D is available only when the RAnalytics+D type is Raid5.

- Manual creation.  
Select disks, click Create Manually and then follow the on-screen instructions to create RAnalytics+D.

### Related Operations

- Change working mode.  
Click to change the working mode of the RAnalytics+D group.
- Delete RAnalytics+D.  
Click to delete the RAnalytics+D group.



When you delete a RAnalytics+D group, the disks in the RAnalytics+D group will be formatted.

### 5.12.3.2 Viewing RAnalytics+D Information

Select Main Menu > STORAGE > RAnalytics+D > RAnalytics+D Info. You can view the RAnalytics+D information, including type, disk space, hot spare, and status.

### 5.12.3.3 Creating Hot Spare Disk

#### Background Information

You can create a hot spare disk. When a disk of the RAnalytics+D group malfunctions, the hot spare disk can replace the malfunctioning disk.

#### Procedure

**Step 1** Select Main Menu > STORAGE > RAnalytics+D > Hotspare Disk.

Figure 5-206 Hotspare disk

RAID	RAID Info	Hotspare Disk				
3	Name	Capacity	Type	RAID Name	Edit	Delete
1	Disk_1	931.46 GB	General HDD	-		-
2	Disk_2	2.72 TB	General HDD	-		-
3	Disk_3	2.72 TB	General HDD	-		-

**Step 2** Click .

Figure 5-207 Local hotspare

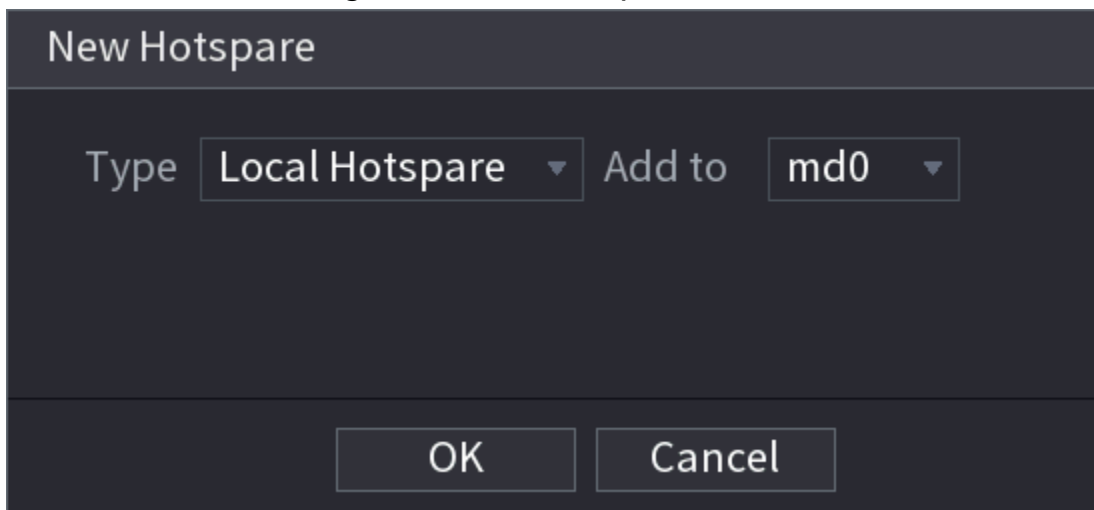
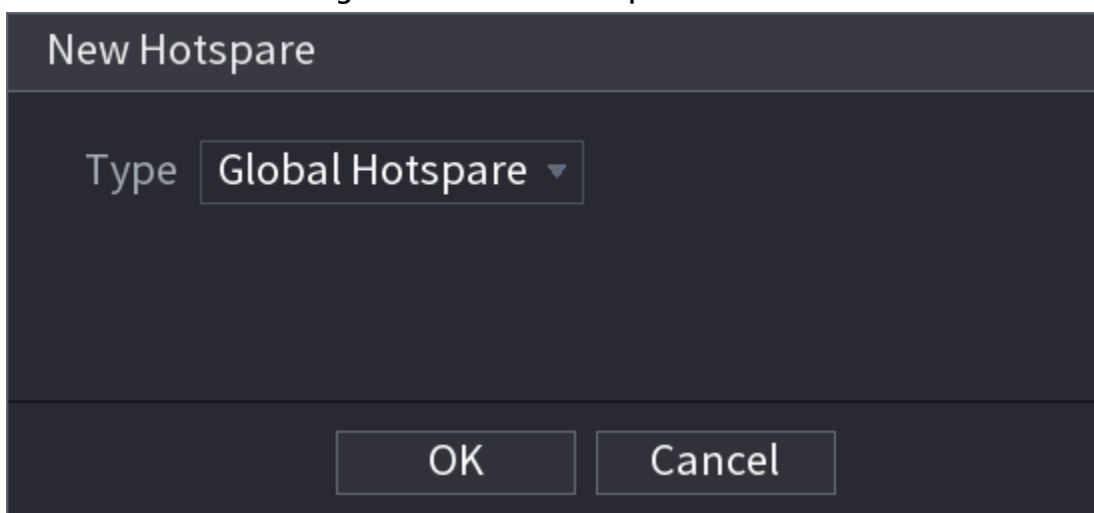

Figure 5-208 Global hotspare



**Step 3** You can select Local Hotspare or Global Hotspare.

- Local Hotspare: Select the target disk, and the current disk will serve as the hot spare disk for the selected target disk.
- Global Hotspare: The current disk will serve as the hot spare disk of the entire RAnalytics+D.

**Step 4** Click OK.



Click  to delete a hot spare disk.

## 5.12.4 Disk Group

### Background Information

By default, the installed HDD and created RAnalytics+D are in Disk Group 1. You can set HDD group, and HDD group setup for main stream, sub stream and snapshot operation.

## Procedure

**Step 1** Select Main Menu > STORAGE > Disk Group.

Figure 5-209 Disk group

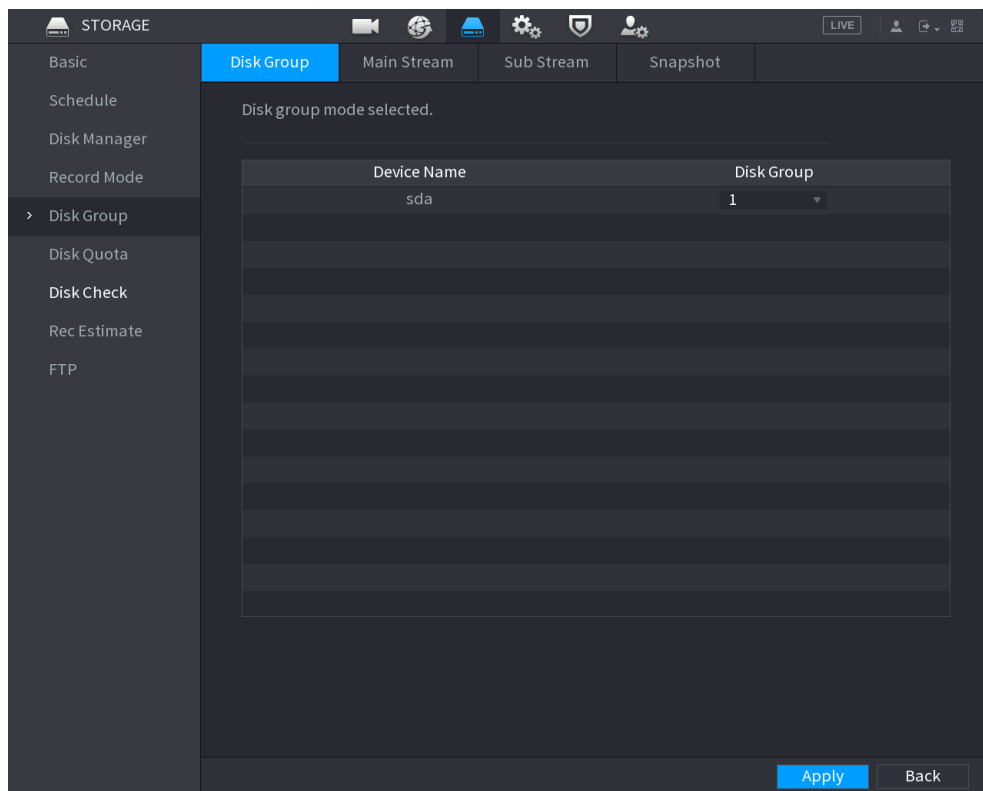

**Step 2** (Optional) If Disk Quota is selected is shown on the page, click Switch to Disk Group Mode and then follow the on-screen instructions to format disks.

**Step 3** Select the group for each HDD, and then click Apply.

After configuring HDD group, under the Main Stream tab, Sub Stream tab and Snapshot tab, configure settings to save the main stream, sub stream and snapshot to different disk groups.

## 5.12.5 Disk Quota

You can allocate a certain storage capacity for each channel to manage the storage space properly.

### Background Information



- If Disk group mode selected. is shown in the interface, click Switch to Quota Mode.
- Disk quota mode and disk group mode can not be selected at the same time.

## Procedure

**Step 1** Select Main Menu > STORAGE > Disk Quota.



Figure 5-210 Disk Quota

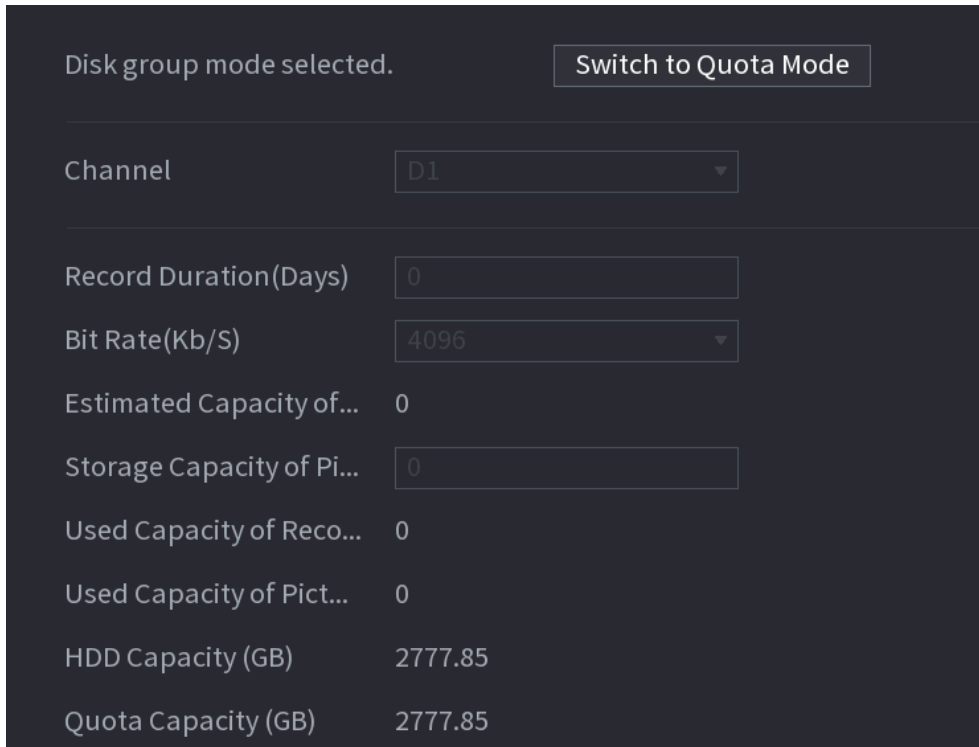

Disk group mode selected.		Switch to Quota Mode
Channel	D1	
Record Duration(Days)	0	
Bit Rate(Kb/S)	4096	
Estimated Capacity of...	0	
Storage Capacity of Pi...	0	
Used Capacity of Reco...	0	
Used Capacity of Pict...	0	
HDD Capacity (GB)	2777.85	
Quota Capacity (GB)	2777.85	

- Step 2** (Optional) If Disk group mode selected is shown on the page, click Switch to Quota Mode and then follow the on-screen instructions to format disks.
- Step 3** Select a channel and set the record duration, bit rate and storage capacity of picture.
- Step 4** Click Apply.

## 5.12.6 Disk Check

The system can detect HDD status so that you can clearly understand the HDD performance and replace the malfunctioning HDD.

### 5.12.6.1 Manual Check

#### Procedure

- Step 1** Select Main Menu > STORAGE > Disk Check > Manual Check.

Figure 5-211 Manual check

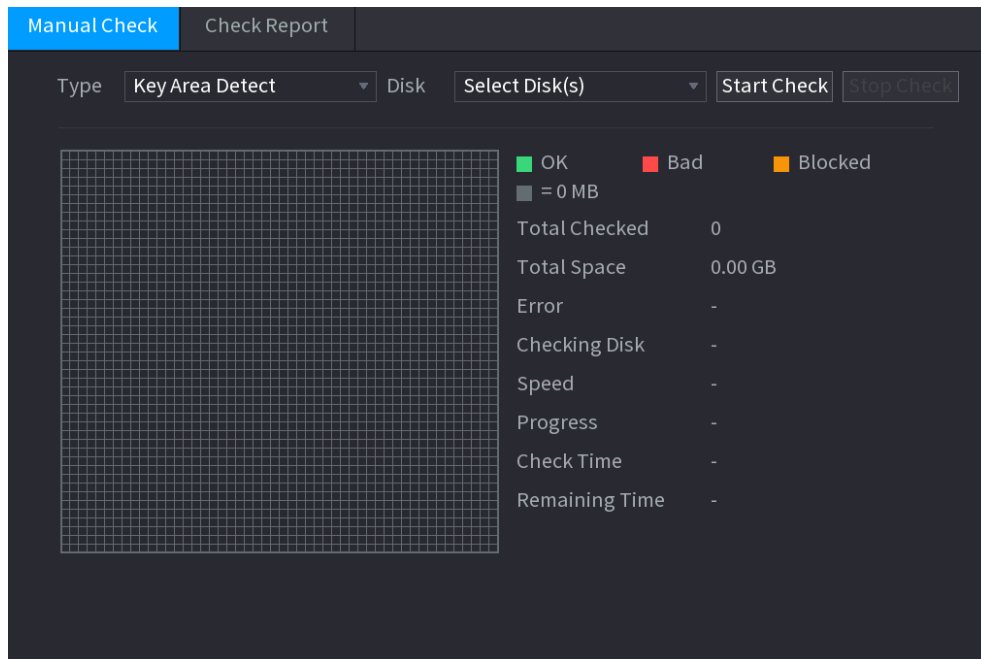

**Step 2** Select the detection type.

- Key area detection: The system detects the used space of the HDD through the built-in file system. This type of detection is efficient.
- Global detection: The system detects the entire HDD through Window. This type of detection takes time and might affect the HDD that is recording.

**Step 3** Select the HDD that you want to detect

**Step 4** Click Start Check.

The system starts detecting the HDD and displays the detection information.



When system is detecting HDD, click Stop Check to stop current detection. Click Start Check to detect again.

## 5.12.6.2 Detection Report

### Background Information

After the detection operation, you can view the detection report.

### Procedure

**Step 1** Select Main Menu > STORAGE > Disk Check > Check Report.

Figure 5-212 Check report

Manual Check		Check Report			
1	Disk No.	Check Type	Start Time	Total Space	Er
1	Host-2	Key Area Detect	2020-02-23 18:55:09	2794.52 GB	

**Step 2** Click  to view detection results and S.M.A.R.T report.

Figure 5-213 Results

Details

**Results** S.M.A.R.T

Type

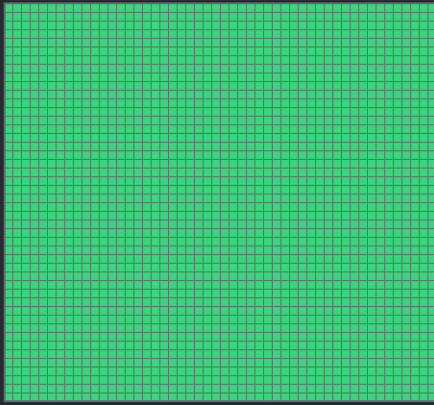

■ OK    ■ Bad    ■ Blocked  
■ = 1244 MB

Total Checked: 1

Total Space: 2794.52 GB

Error: 0

Disk No.: 2

Bad Sector List

No.	Sector No

Figure 5-214 S.M.A.R.T

Details

Results **S.M.A.R.T**

Name sda

Model

SN

Health Status OK

Description:

ID	Attribute	Threshold	Value	Worst	Current Value	He
1	Read Error Rate	16	100	100	0	
2	Through Put Performance	54	135	135	85	
3	Spin Up Time	24	253	253	115	
4	Start/Stop Count	0	97	97	14390	
5	Reallocated Sector Count	5	100	100	58	

### 5.12.6.3 Disk Health Monitoring

Monitor health status of disks, and repair if any exceptions are found so as to avoid data loss.

Select Main Menu > STORAGE > Disk Check > Health Monitoring.

Click ⓘ to show disk details interface. Then select Check Type, set time period, and then click Search. The system shows the details of disk monitoring status.

Figure 5-215 Disk details

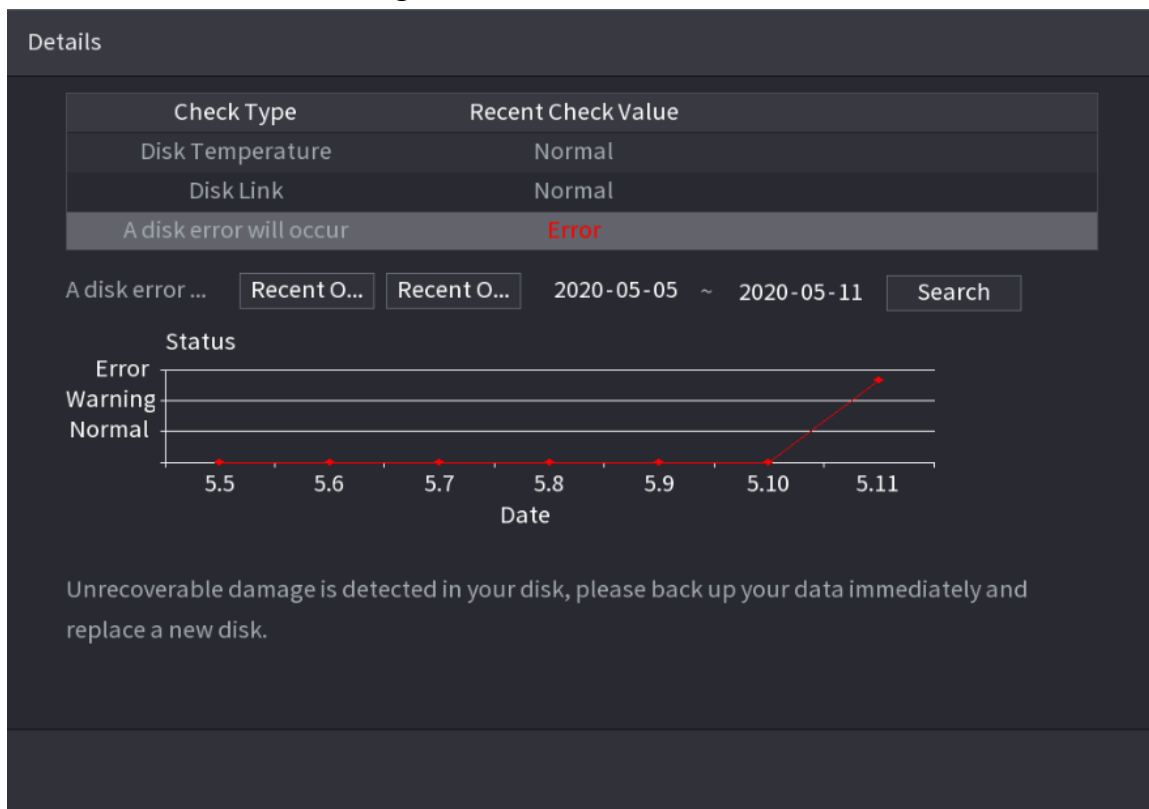

## 5.12.7 Record Estimate

### Background Information

Record estimate function can calculate how long you can record video according to the HDD capacity, and calculate the required HDD capacity according to the record period.

### Procedure

Step 1 Select Main Menu > STORAGE > Rec Estimate.

Figure 5-216 Record estimation

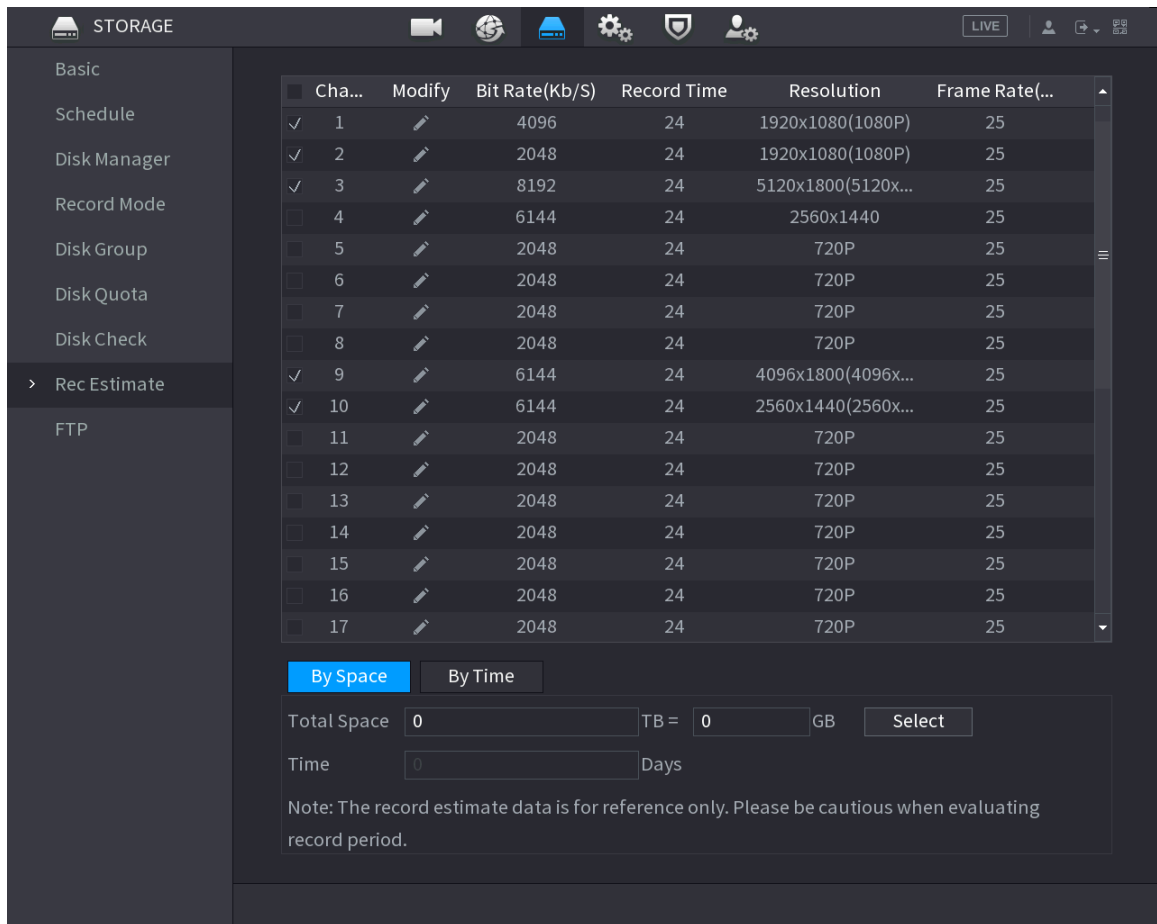

**Step 2** Click .

You can configure the Resolution, Frame Rate, Bit Rate and Record Time for the selected channel.

Figure 5-217 Modify channel settings

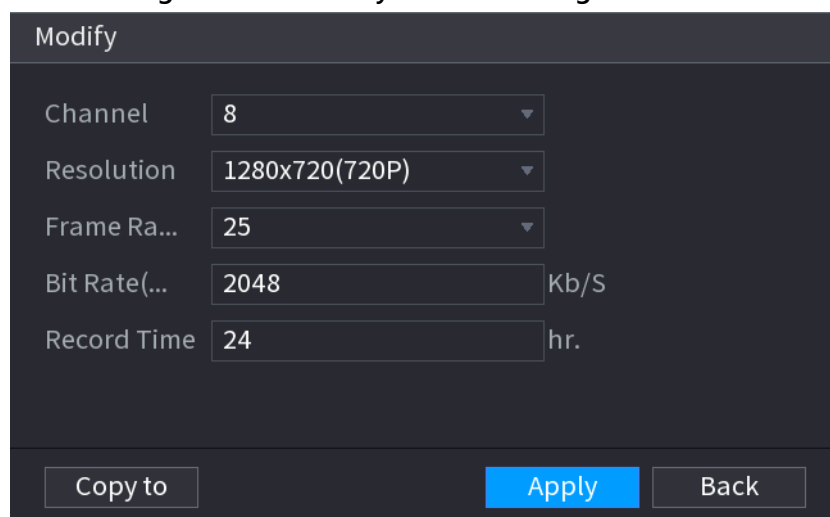

**Step 3** Click Apply.

Then the system will calculate the time period that can be used for storage according to the channels settings and HDD capacity.



Click Copy to to copy the settings to other channels.

### 5.12.7.1 Calculating Recording Time

#### Procedure

**Step 1** On the Rec Estimate interface, click the By Space tab.

Figure 5-218 By space

By Space By Time

Total Space 0 TB = 0 GB Select

Time 0 Days

Note: The record estimate data is for reference only. Please be cautious when evaluating record period.

**Step 2** Click Select.

**Step 3** Select the checkbox of the HDD that you want to calculate.

Figure 5-219 Recording time

By Space By Time

Total Space 2.982 TB = 2982 GB Select

Time 10 Days

Note: The record estimate data is for reference only. Please be cautious when evaluating record period.

### 5.12.7.2 Calculating HDD Capacity for Storage

#### Procedure

**Step 1** On the Rec Estimate interface, click the By Time tab.

Figure 5-220 By time

By Space By Time

Time 0 Days

Total Space 0 TB = 0 GB

Note: The record estimate data is for reference only. Please be cautious when evaluating record period.

**Step 2** In the Time box, enter the time period that you want to record.  
In the Total Space box, the required HDD capacity is displayed.

## 5.12.8 FTP

You can store and view the recorded videos and snapshots on the FTP server.

### Prerequisites

Purchase or download a FTP (File Transfer Protocol) server and install it on your PC.



For the created FTP user, you need to set the write permission; otherwise the upload of recorded videos and snapshots will be failed.

### Procedure

**Step 1** Select Main Menu > STORAGE > FTP.

Figure 5-221 FTP

Enable   FTP  SFTP (Recommended)

Server Address  Port  ( 1 - 65535 )

Username

Password   Anonymous

Storage Path

Record

File Size  M

Channel

Day  Event  General

Period 1

Period 2

Snapshot

Picture Upload Interval  sec.

Channel

Default Test Apply Back

**Step 2** Configure the parameters.



Table 5-67 FTP parameters

Parameter	Description
Enable	Enable the FTP upload function.
FTP type	Select FTP type. <ul style="list-style-type: none"> <li>• FTP: Plaintext transmission.</li> <li>• SFTP: Encrypted transmission (recommended).</li> </ul>
Server Address	IP address of FTP server.
Port	Enter the port of the FTP server. <ul style="list-style-type: none"> <li>• FTP: The default is 21.</li> <li>• SFTP: The default is 22.</li> </ul>
Username	Enter the username and password to log in to the FTP server. If you enable the anonymity function, you can log in anonymously without entering the username and password.
Password	
Anonymous	
Storage Path	Create folder on FTP server. <ul style="list-style-type: none"> <li>• If you do not enter the name of remote directory, the system automatically creates the folders according to the IP and time.</li> <li>• If you enter the name of remote directory, the system creates the folder with the entered name under the FTP root directory first, and then automatically creates the folders according to the IP and time.</li> </ul>
File Size	Enter the length of the uploaded recorded video. <ul style="list-style-type: none"> <li>• If the entered length is less than the recorded video length, only a section of the recorded video can be uploaded.</li> <li>• If the entered length is more than the recorded video length, the whole recorded video can be uploaded.</li> <li>• If the entered length is 0, the whole recorded video will be uploaded.</li> </ul>
Picture Upload Interval	<ul style="list-style-type: none"> <li>• If this interval is longer than snapshot interval, the system takes the recent snapshot to upload. For example, the interval is 5 seconds, and snapshot interval is 2 seconds per snapshot, the system uploads the recent snapshot every 5 seconds.</li> <li>• If this interval is shorter than snapshot interval, the system uploads the snapshot per the snapshot interval. For example, the interval is 5 seconds, and snapshot interval is 10 seconds per snapshot, the system uploads the snapshot every 10 seconds.</li> <li>• To configure the snapshot interval, go to Main Menu &gt; CAMERA &gt; Encode &gt; Snapshot.</li> </ul>
Channel	Select the channel that you want to apply the FTP settings.
Day	Select the week day and set the time period that you want to upload

Parameter	Description
Period 1, Period 2	the recorded files. You can set two periods for each week day.
Record type	Select the record type (Alarm, Intel, MD, and General) that you want to upload. The selected record type will be uploaded during the configured time period.

**Step 3** Click Test to validate the FTP connection.

If FTP connection failed, check the network and FTP settings.

**Step 4** Click Apply.

## 5.12.9 iSCSI

### Background Information

Internet Small Computer Systems Interface (iSCSI) is a transport layer protocol that works on top of the Transport Control Protocol (TCP), and enables block-level SCSI data transport between the iSCSI initiator and the storage target over TCP/IP networks. After the network disk is mapped to the NVR device through iSCSI, the data can be stored on the network disk.



This function is available on select models.

### Procedure

**Step 1** Select Main Menu > STORAGE > iSCSI.

Figure 5-222 iSCSI

Server Address: [IP Address]

Port: 3260 (3260-65535)

Anonymous:

Username: ryl13209

Password: [Masked]

Storage Path: iqn.2013-04.com.yze4ez159w00... Storage Path

No.	Status	IP Address	Port	Username	Storage Path
ISCSI1	×	[IP Address]	3260	ryl13209	2211

Buttons: Add, Delete, Modify, Default, Apply, Back

**Step 2** Set parameters.

Table 5-68 iSCSI parameters

Parameter	Description
Server Address	Enter the server address of iSCSI server.
Port	Enter the port of iSCSI server, and the default value is 3260.
Storage Path	Click Storage Path to select a remote storage path. Each path represents an iSCSI shared disk and these paths are generated when created on the server
Username, Password	Enter the username and password of iSCSI server.  If anonymous login is supported by iSCSI server, you can enable Anonymous to log in as an anonymous user.

**Step 3** Click Apply.

## 5.13 Account

You can manage users, user group and ONVIF user, and set admin security questions.



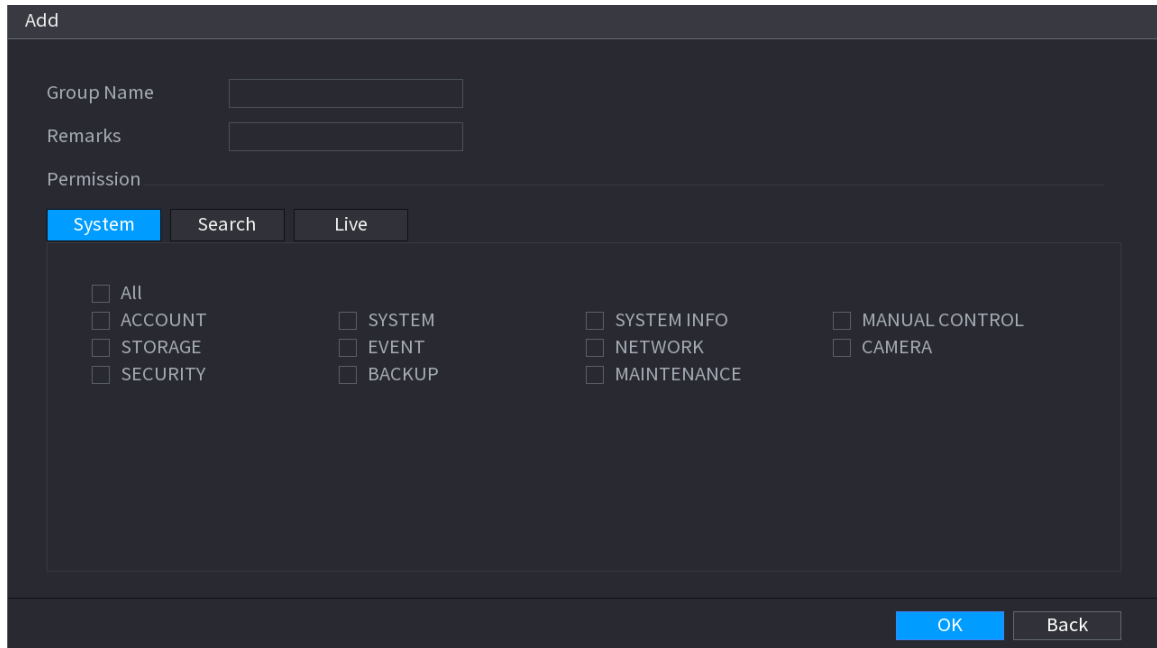

Figure 5-224 Add group



**Step 4** Select the checkboxes to select permissions.

**Step 5** Click OK.



Click  to modify the corresponding group information, click  to delete the group.

## 5.13.2 User

### 5.13.2.1 Adding User

#### Procedure

**Step 1** Select Main Menu > ACCOUNT > User.

Figure 5-225 User

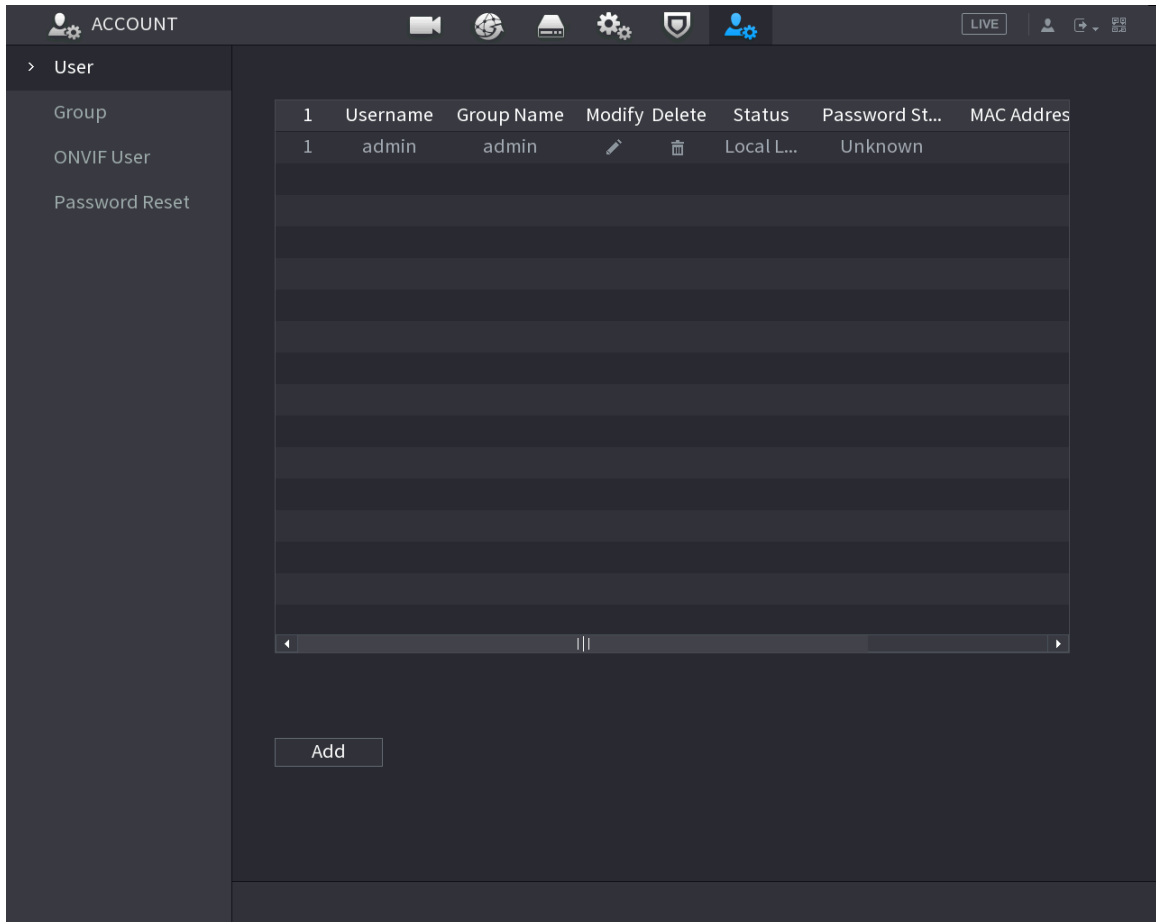

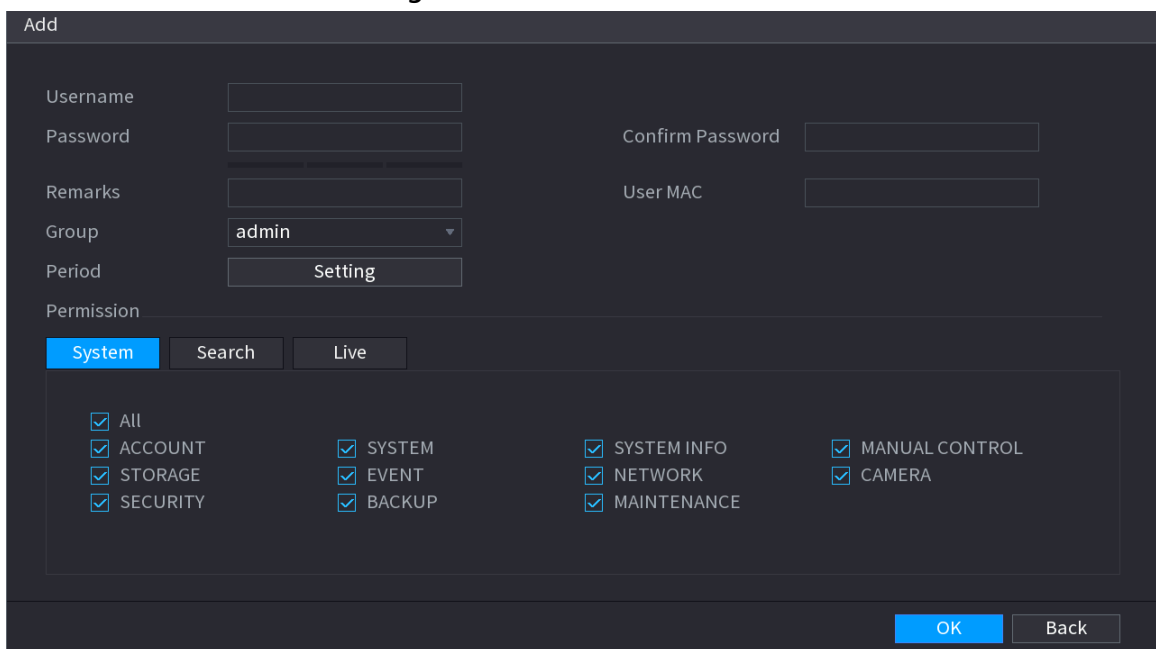

**Step 2** Click Add.

Figure 5-226 Add user



**Step 3** Configure the parameters.

Table 5-69 Parameters of adding user

Parameter	Description
Username	Enter a username and password for the account.
Password	
Confirm Password	Enter the password again to confirm it.
Remarks	Optional. Enter a description of the account.
User MAC	Enter user MAC address
Group	Select a group for the account.  The user rights must be within the group permissions.
Period	Click Setting to define a period during which the new account can log in to the Device. The new account cannot access the device during other periods.
Permission	Select the checkboxes to grant permissions to the user.  To manage the user account easily, when defining the user account permission, do not give the authority to the common user account higher than the advanced user account.

**Step 4** Click OK.



Click  to modify the corresponding user information, click  to delete the user.

## 5.13.2.2 Changing Password

### Background Information

We recommend you change the password regularly to enhance device security.



Users with account permissions can change the password of other users.

### Procedure

**Step 1** Select Main Menu > ACCOUNT > User.

**Step 2** Click  of the corresponding user.

Figure 5-227 Change password

**Step 3** Click to enable the Modify Password function.

**Step 4** Enter old password and then enter new password twice.



- The password must consist of 8–32 non-blank characters and contain at least two types of the following characters: uppercase, lowercase, numbers, and special characters (excluding ' " ; : &).
- For your device security, create a strong password.
- Check the box to enable Unlock Pattern function, click .

**Step 5** Click to enable Unlock Pattern and then click to draw the pattern.

**Step 6** Click OK.

## 5.13.3 Resetting Password

You can reset the password when you forget the password.

### 5.13.3.1 Enabling Password Reset

#### Background Information

Enable the password reset function and configure the linked email address and security questions that are used to reset the password.

#### Procedure

**Step 1** Select Main Menu > ACCOUNT > Password Reset.

**Step 2** Click to enable the password reset function.





This function is enabled by default.

**Step 3** Enter an email address to receive the security code used to reset the password.

**Step 4** Configure security questions and answers.

**Step 5** (Optional) Follow the on-screen instructions to bind the Device to DMSS app.

Figure 5-228 Bind device

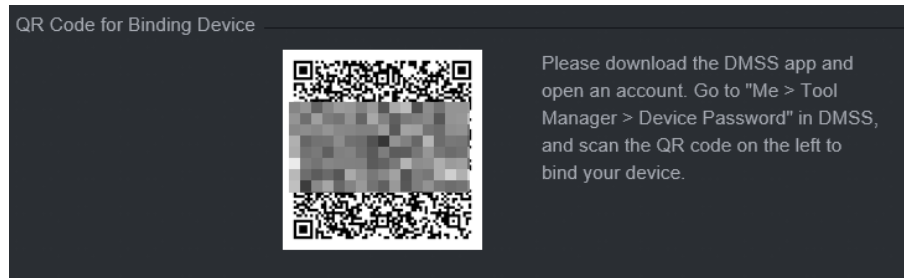

**Step 6** Click OK.

### 5.13.3.2 Resetting Password on Local Interface

#### Procedure

- Step 1** Right-click the live page and then select any item on the shortcut menu.
- If you have configured unlock pattern, the unlock pattern login window is displayed. Click Forgot Pattern to switch to password login.
  - If you did not configure unlock pattern, the password login window is displayed.

Figure 5-229 Pattern login

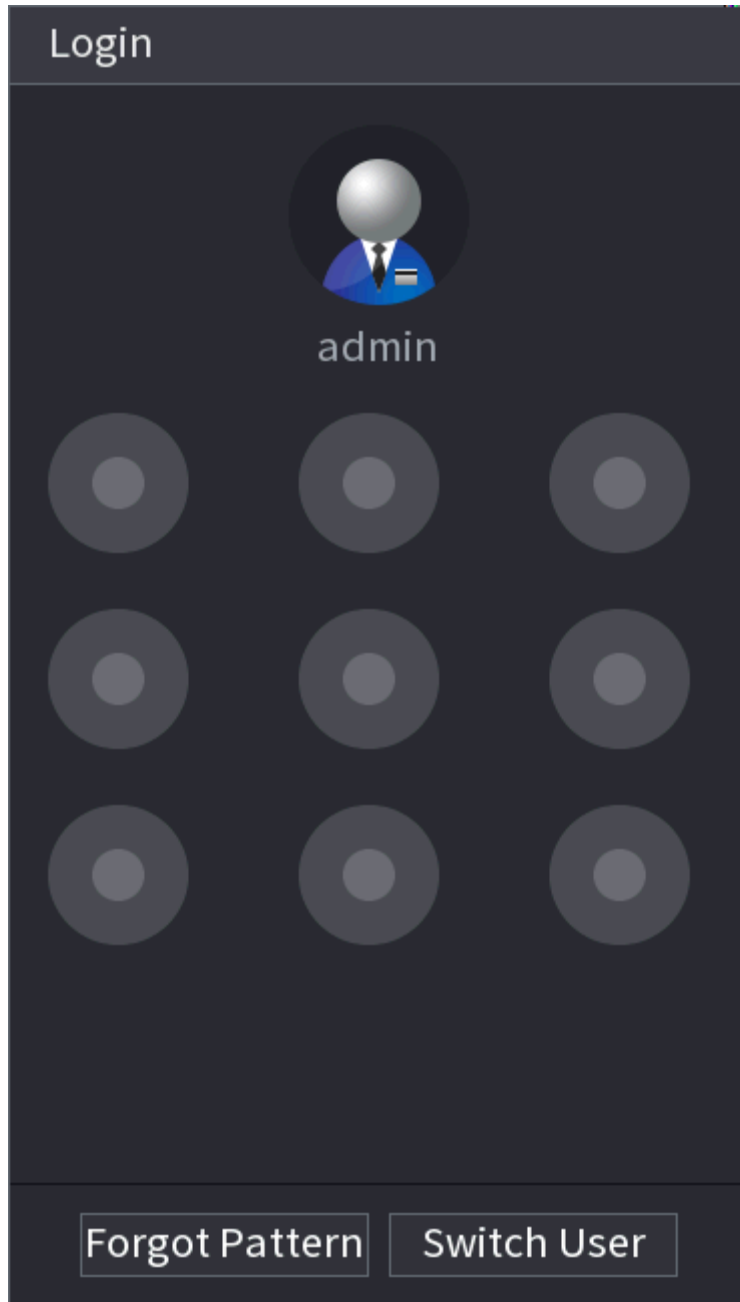
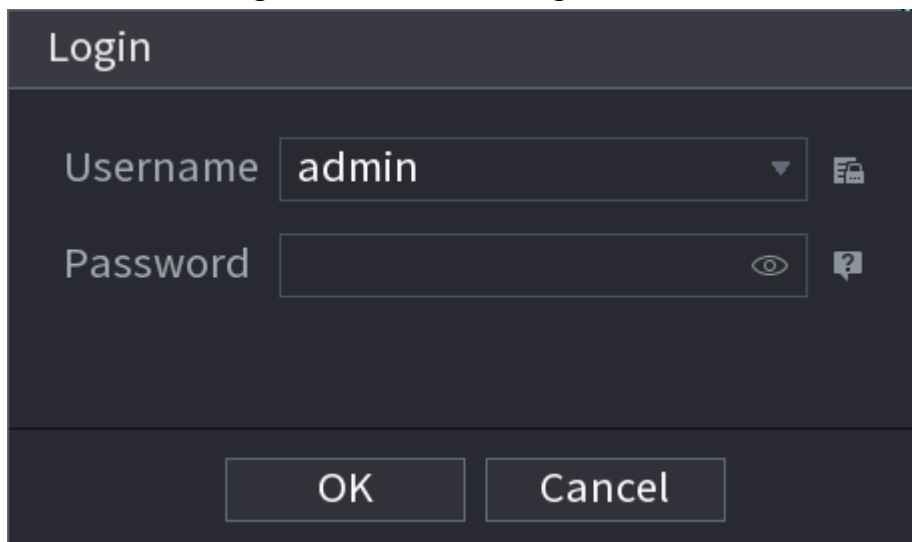

Figure 5-230 Password login



**Step 2** Click .

- If you have set the linked email address, the system will notify you of data collection required for resetting password. Click OK.
- If you did not set the linked email address, the system prompts you to enter an email address. Enter the email address and then click Next. Then the system will notify you of data collection required for resetting password.

Figure 5-231 Notification on data collection

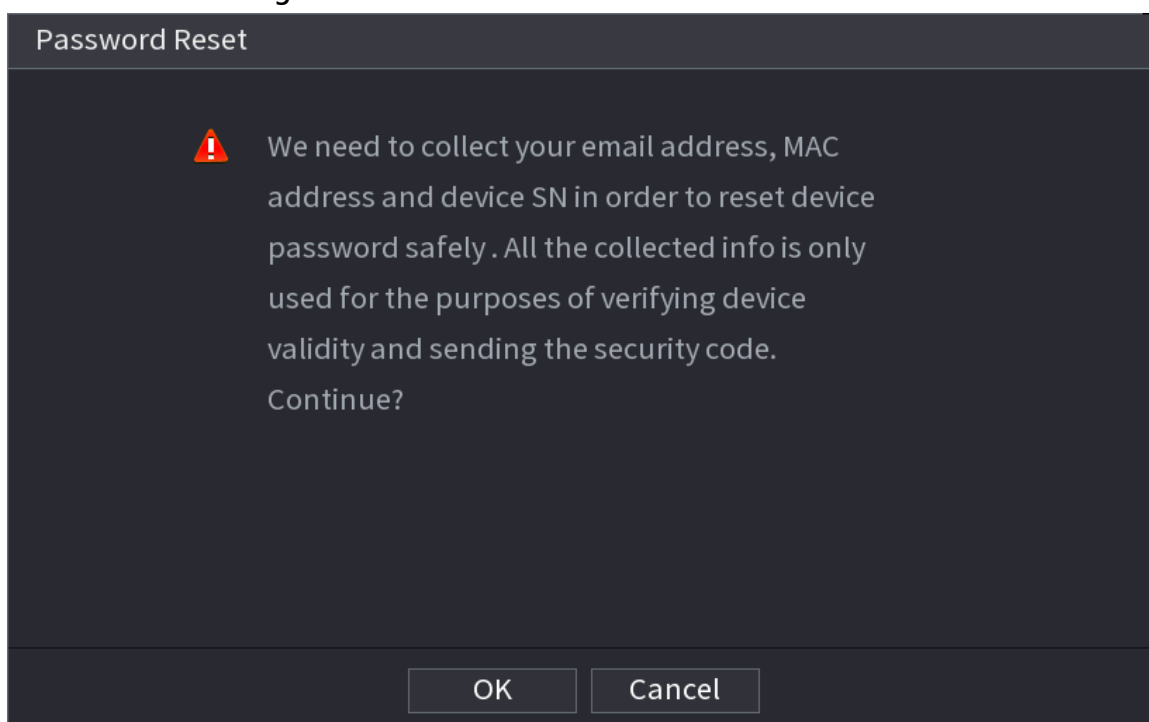

**Step 3** Read the prompt and then click OK.

**Step 4** Click Next.



After clicking Next, the system will collect your information for password reset, purpose and the information includes but not limited to email address, MAC address, and device serial number. Read the prompt carefully before clicking Next.

**Step 5** Reset the password.

- Email.

Select Email as the reset mode, and then follow the on-screen instructions to get the security code in your linked email address. After that, enter the security code in the Security Code box.

Figure 5-232 Reset mode (email)

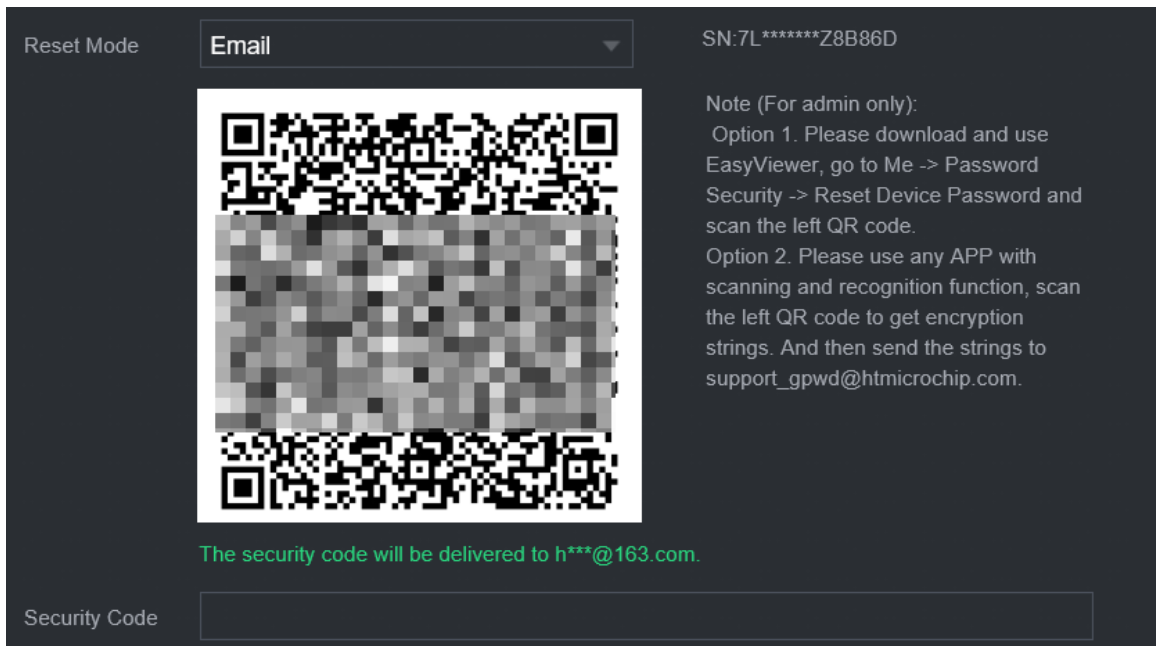

- App.Select QR Code for Binding Device as the reset mode, and then follow the on-screen instructions to get the security code on the DMSS app. After that, enter the security code in the Security Code box.

Figure 5-233 Reset mode (app)

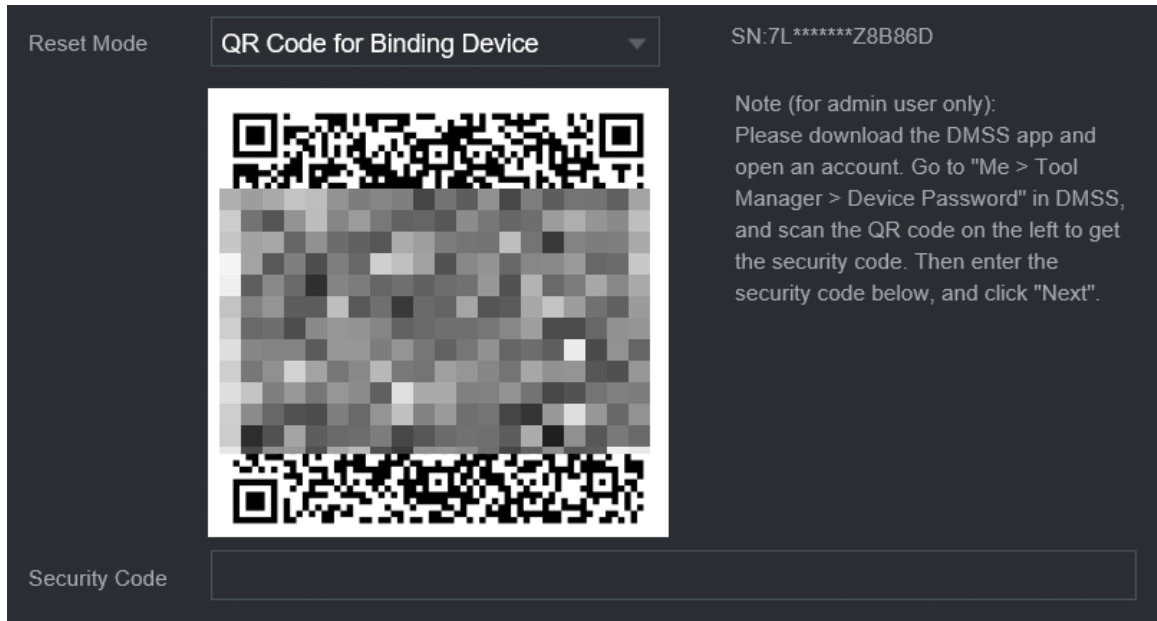

- Security question.  
Select Security Question as reset mode and then answer the security questions.



If you did not configure the security questions in advance , Security Question is not available on the Reset Mode list.

**Step 6** Click Next.

**Step 7** Enter the new password and then enter the password again to confirm it.

Figure 5-234 Enter new password

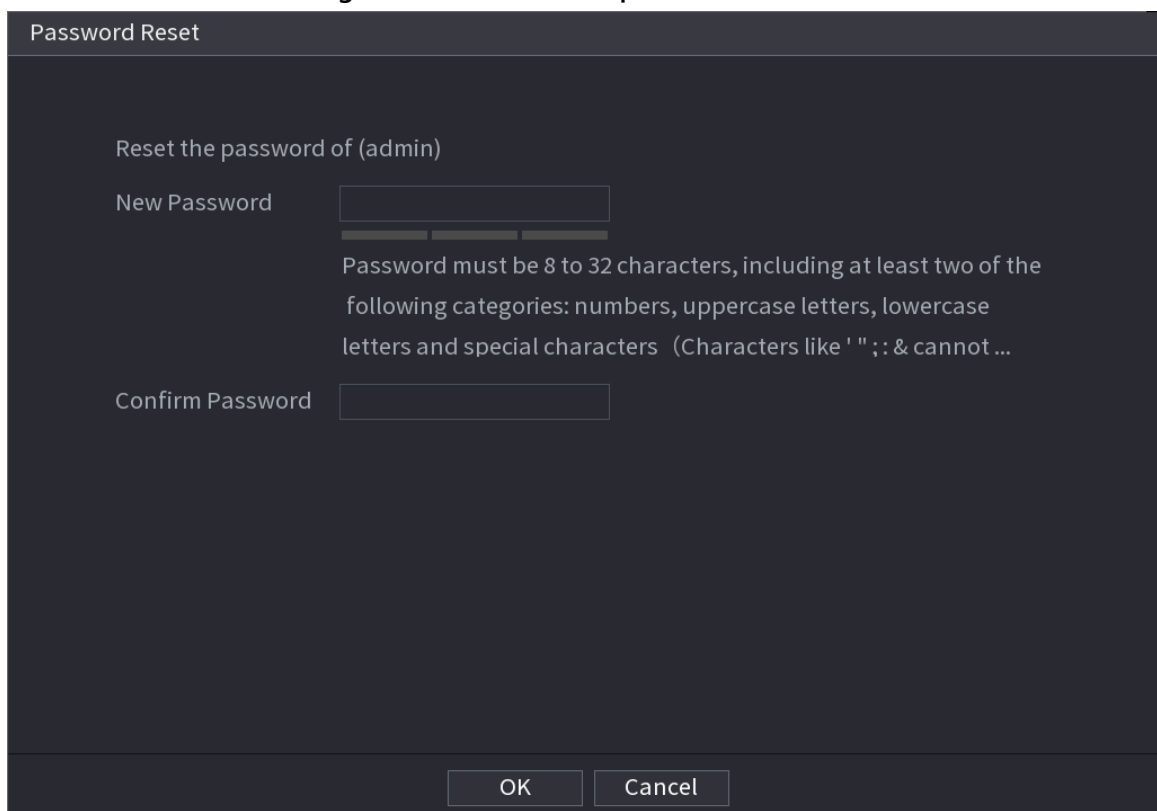

**Step 8** Click OK.

The password is reset.

**Step 9** (Optional) When the system prompts whether to synchronize the password with the remote devices accessed through the private protocol, click OK to synchronize the password.

## 5.13.4 ONVIF User

### Background Information

To connect the camera from the third party to the NVR via the ONVIF protocol, you need to use a verified ONVIF account.



The default ONVIF user is admin. It is created after you initialize the NVR and cannot be deleted.

### Procedure

**Step 1** Select Main Menu > ACCOUNT > ONVIF User.

Figure 5-235 ONVIF user

1	Username	Group Name	Modify	Delete	Password S...
1	admin	admin			Medium

Add

**Step 2** Click Add.

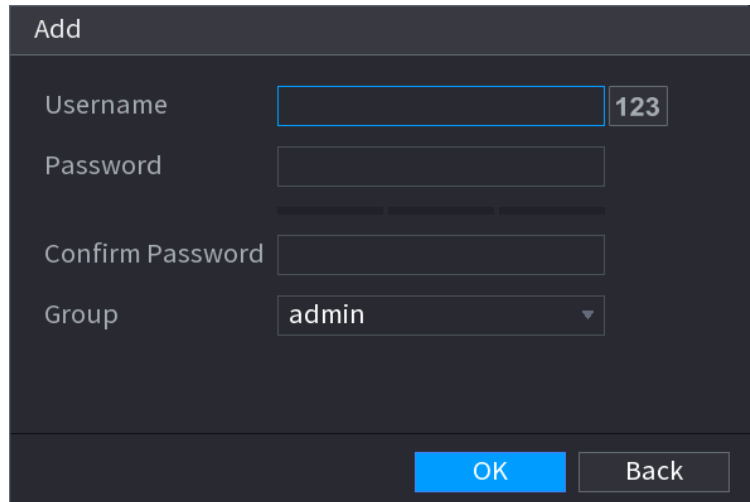

Figure 5-236 Add ONVIF user



**Step 3** Configure username, password and user group.

**Step 4** Click OK.



Click  to modify the corresponding user information, click  to delete current user.

## 5.14 Security

### 5.14.1 Security Status

Security scanning helps get a whole picture of device security status. You can scan user, service and security module status for detailed information on the security status of the device.

#### Detecting User and Service



Green icon represents a healthy status of the scanned item, and orange icon represents a risky status.

- Login authentication: When there's a risk in the device configuration, the icon will be in orange to warn risk. You can click Details to see the detailed risk description.
- User Status: When one of device users or ONVIF users uses weak password, the icon will be in orange to warn risk. You can click Details to optimize or ignore the risk warning.

Figure 5-237 Security status

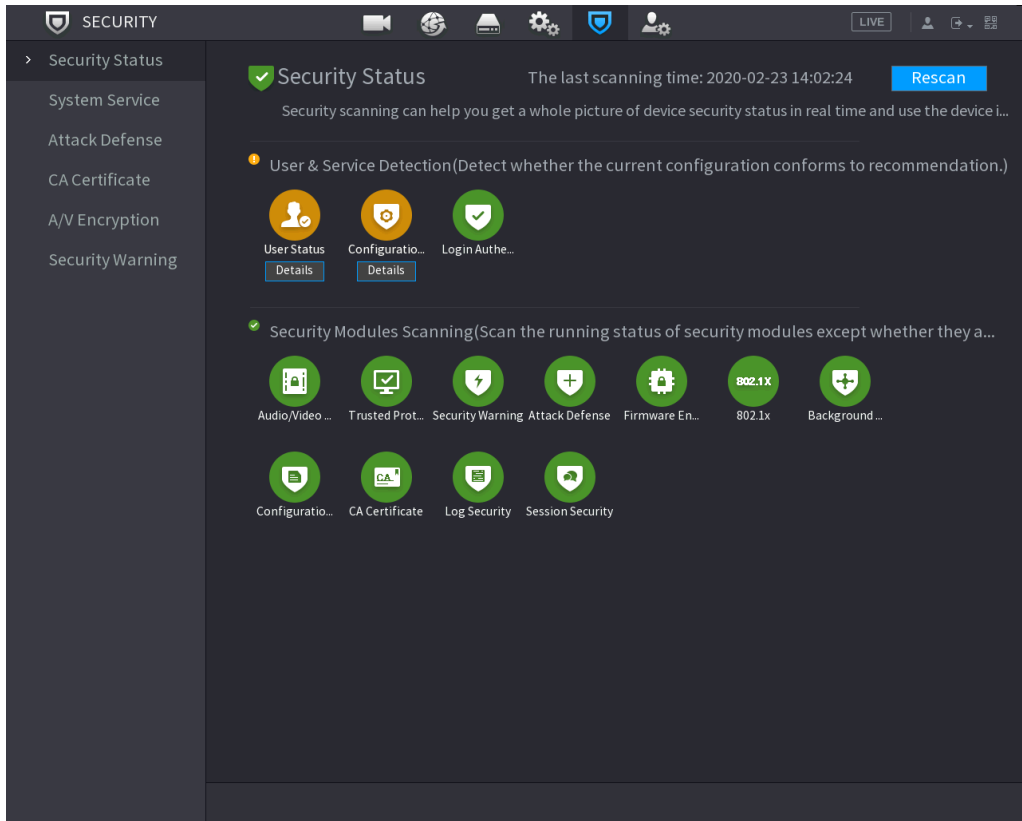
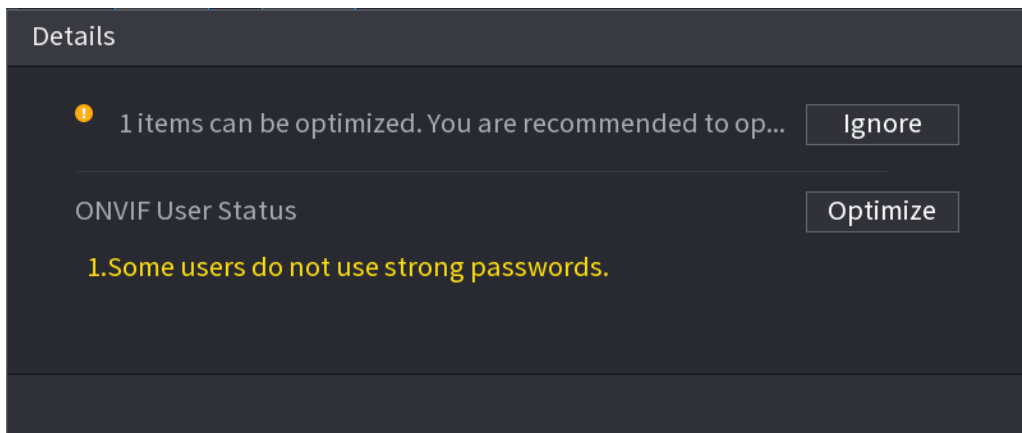

Figure 5-238 Details (1)



- Configuration Security: When there's a risk in the device configuration, the icon will be in orange to warn risk. You can click Details to see the detailed risk description.



Figure 5-239 Details (2)

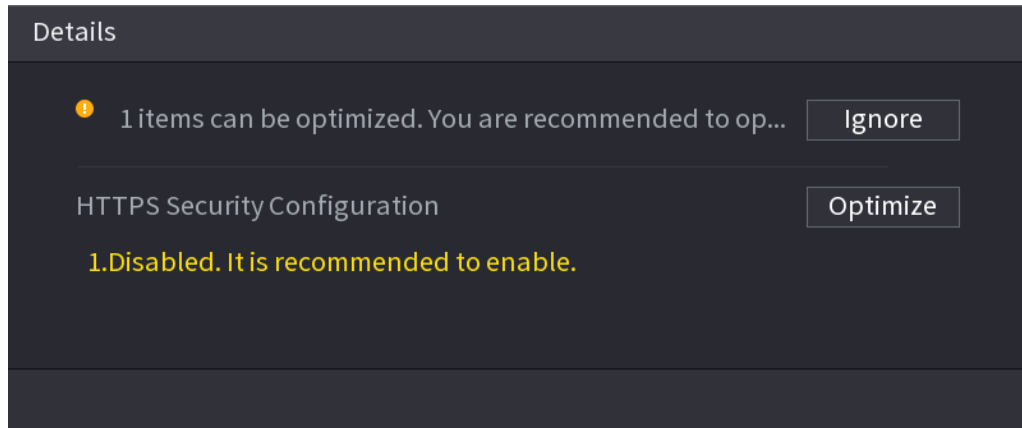

## Scanning Security Modules

This area shows the running status of security modules. For details about the security modules, point to the icon to see the on-screen instructions.

## Re-scanning Security Status

You can click Rescan to scan security status.

## 5.14.2 System Service

You can set NVR basic information such as basic services, 802.1x and HTTPS.

### 5.14.2.1 Basic Services

#### Procedure

**Step 1** Select Main Menu > SECURITY > System Service > Basic Services.

Figure 5-240 Basic services

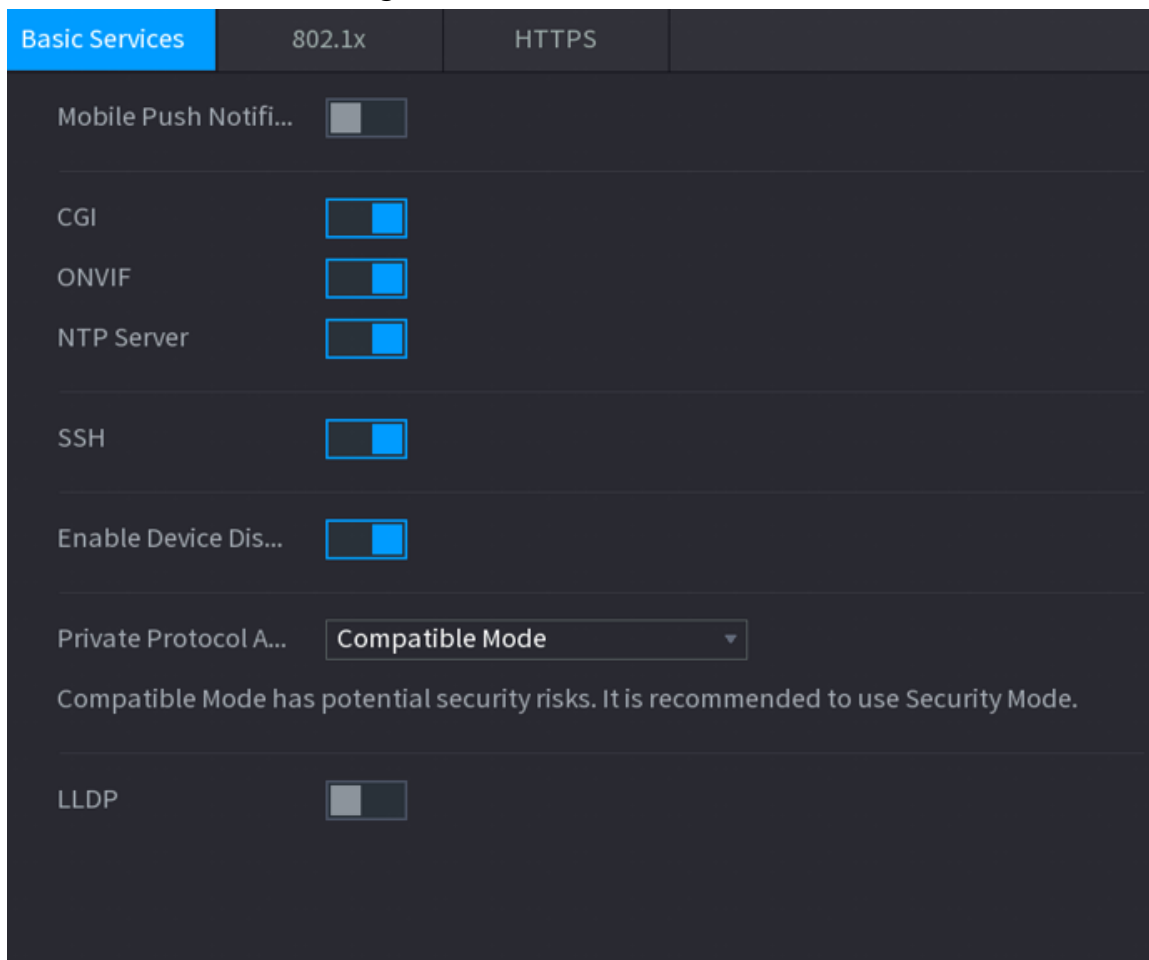

**Step 2** Enable the system services.



There might be safety risk when Mobile Push Notifications, CGI, ONVIF, SSH and NTP Server is enabled. Disable these functions when they are not needed.

Table 5-70 Basic service parameters

Parameter	Description
Mobile Push Notifications	After enabling this function, the alarm triggered by the NVR can be pushed to a mobile phone. This function is enabled by default.
CGI	If this function is enabled, the remote devices can be added through the CGI protocol. This function is enabled by default.
ONVIF	If this function is enabled, the remote devices can be added through the ONVIF protocol. This function is enabled by default.
NTP Server	After enabling this function, a NTP server can be used for time synchronization. This function is enabled by default.
SSH	After enabling this function, you can use SSH service. This function is disabled by default.

Parameter	Description
Enable Device Discovery	After enabling this function, the NVR can be found by other devices through searching.
Private Protocol Authentication Mode	<ul style="list-style-type: none"><li>• Security Mode (Recommended): Uses Digest access authentication when connecting to NVR.</li><li>• Compatible Mode: Select this mode when the client does not support Digest access authentication.</li></ul>
LLDP	Enable the LLDP service. The Link Layer Discovery Protocol (LLDP) allows two different devices to collect hardware and protocol information about neighboring devices, which is useful in troubleshooting the network.

**Step 3** Click Apply.

### 5.14.2.2 802.1x

The Device needs to pass 802.1x certification to enter the LAN.

#### Procedure

**Step 1** Select Main Menu > SECURITY > System Service > 802.1x.

Figure 5-241 802.1x

**Step 2** Select the Ethernet card you want to certify.

**Step 3** Select Enable and configure parameters.

Table 5-71 802.1x parameters

Parameter	Description
Authentication	<ul style="list-style-type: none"> <li>• PEAP: protected EAP protocol.</li> <li>• TLS: Transport Layer Security. Provide privacy and data integrity between two communications application programs.</li> </ul>
CA Certificate	Enable it and click Browse to import CA certificate from flash drive. For details about importing and creating a certificate, see "5.14.4 CA Certificate".
Username	The username shall be authorized at server.
Password	Password of the corresponding username.

**Step 4** Click Apply.

## 5.14.2.3 HTTPS

### Background Information

We recommend you enable HTTPS function to enhance system security.

### Procedure

**Step 1** Select Main Menu > SECURITY > System Service > HTTPS.

Figure 5-242 HTTPS

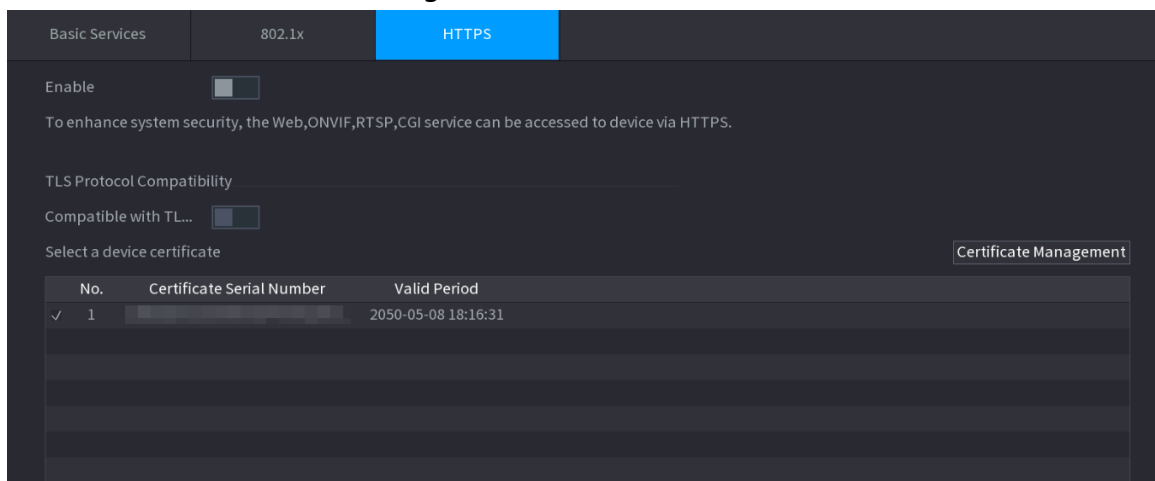

**Step 2** Enable HTTPS function.

**Step 3** (Optional) Enable Compatible with TLSv1.1 and earlier versions to allow protocol compatibility.

**Step 4** Click Certificate Management to create or import a HTTPS certificate from USB drive. For details about importing or creating a CA certificate, see "5.14.4 CA Certificate".

**Step 5** Select a HTTPS certificate.

**Step 6** Click Apply.

## 5.14.3 Attack Defense

### 5.14.3.1 Firewall

#### Background Information

You can configure the hosts that are allowed or prohibited to access the Device.

#### Procedure

**Step 1** Select Main Menu > SECURITY > Attack Defense > Firewall .



### 5.14.3.2 Account Lockout

#### Procedure

**Step 1** Select Main Menu > SECURITY > Attack Defense > Account Lockout.

Figure 5-244 Account lockout

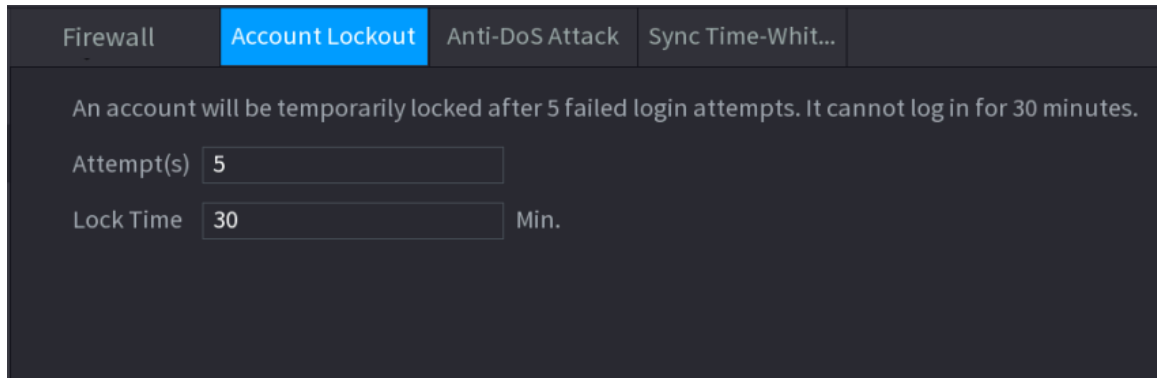

**Step 2** Set parameters.

Table 5-72 Account lockout parameters

Parameter	Description
Attempt(s)	Set the maximum number of allowable wrong password entries. The account will be locked after your entries exceed the maximum number.
Lock Time	Set how long the account is locked for.

**Step 3** Click Apply.

### 5.14.3.3 Anti-DoS Attack

You can enable SYN Flood Attack Defense and ICMP Flood Attack Defense to defend the Device against Dos attack.

Figure 5-245 Anti-Dos Attack

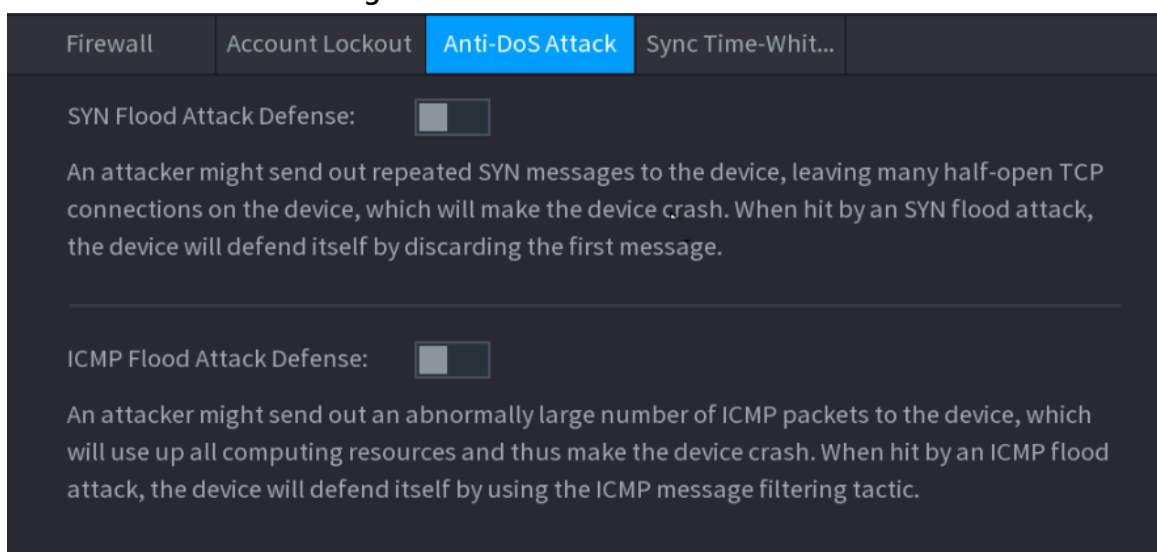

### 5.14.3.4 Sync Time-Allowlist

#### Background Information

You can configure which hosts are allowed to synchronize time with the Device.

#### Procedure

**Step 1** Select Main Menu > SECURITY > Attack Defense > Sync Time-Allowlist.

Figure 5-246 Sync Time-Allowlist

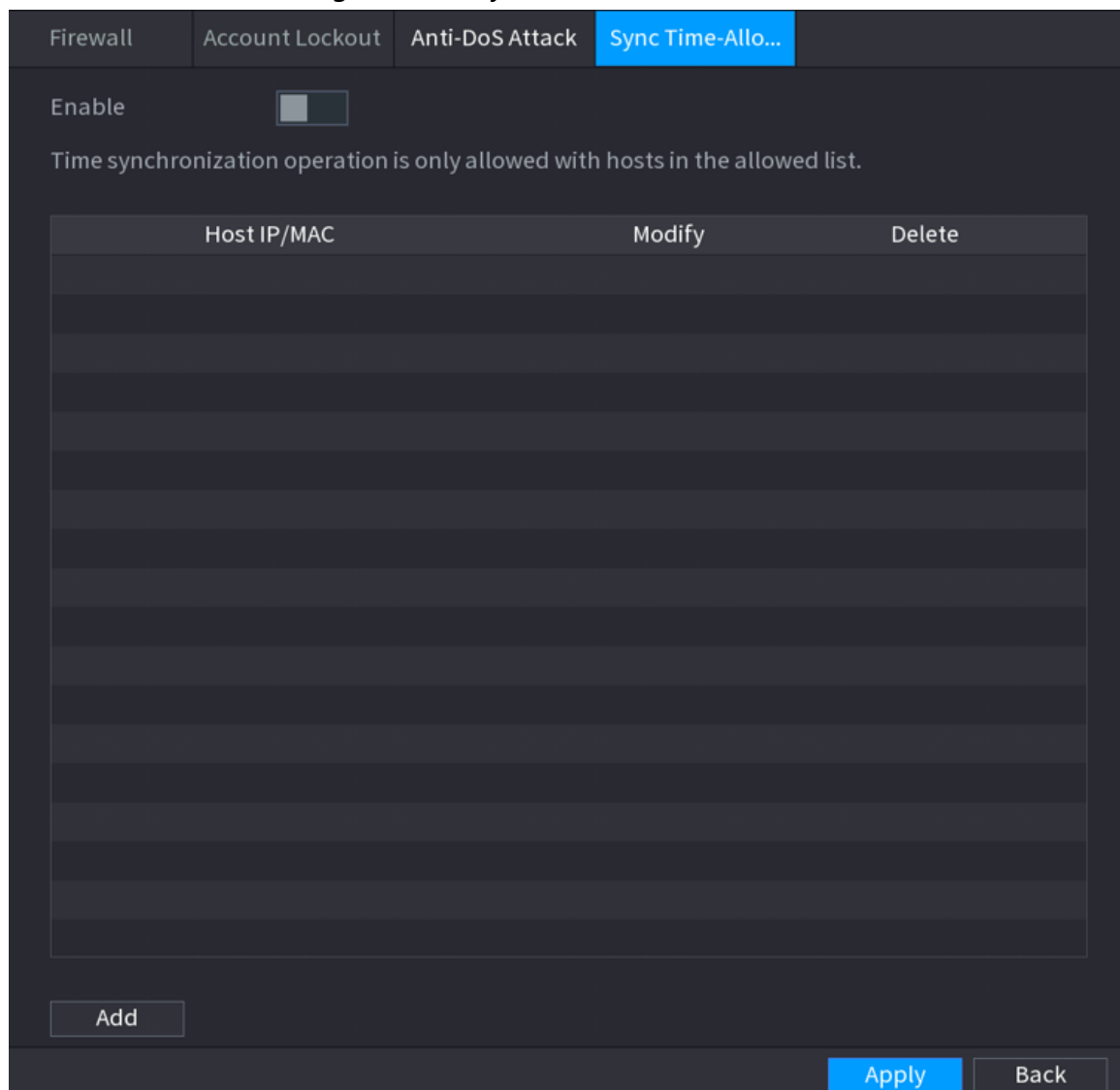

**Step 2** Click  to enable the function.

**Step 3** Click Add to add trusted hosts for time synchronization.

- If you set Type to IP Address, enter the IP address, and then click OK.
- If you set Type to IP Segment, enter the start address and end address, and then click OK.

**Step 4** Click Apply.



## 5.14.4 CA Certificate

### 5.14.4.1 Device Certificate

#### Create Certificate

1. Select Main Menu > SECURITY > CA Certificate > Device Certificate. **Figure 5-247 Device certificate**

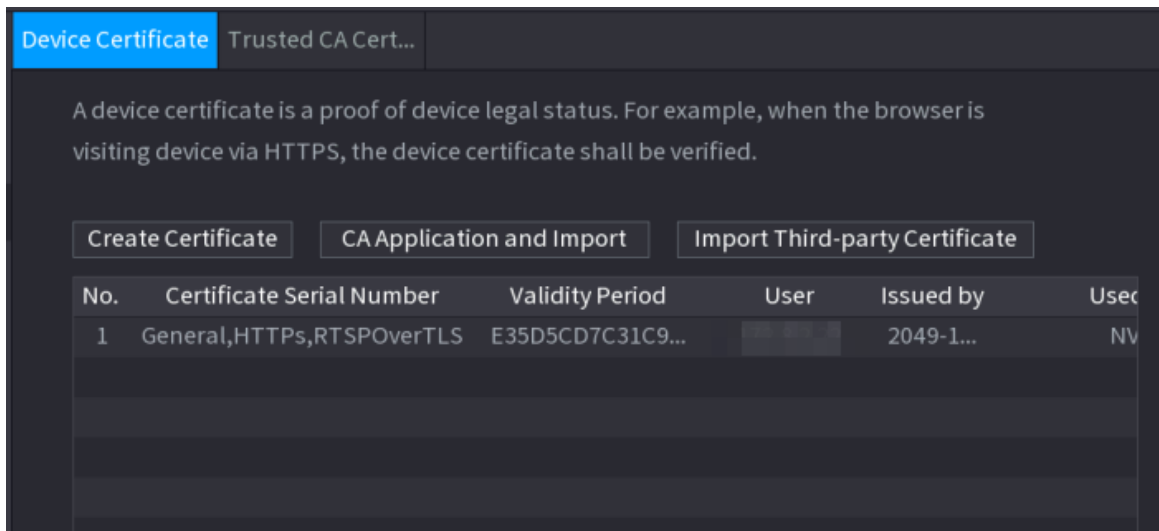

2. Click Create Certificate.

Figure 5-248 Create certificate

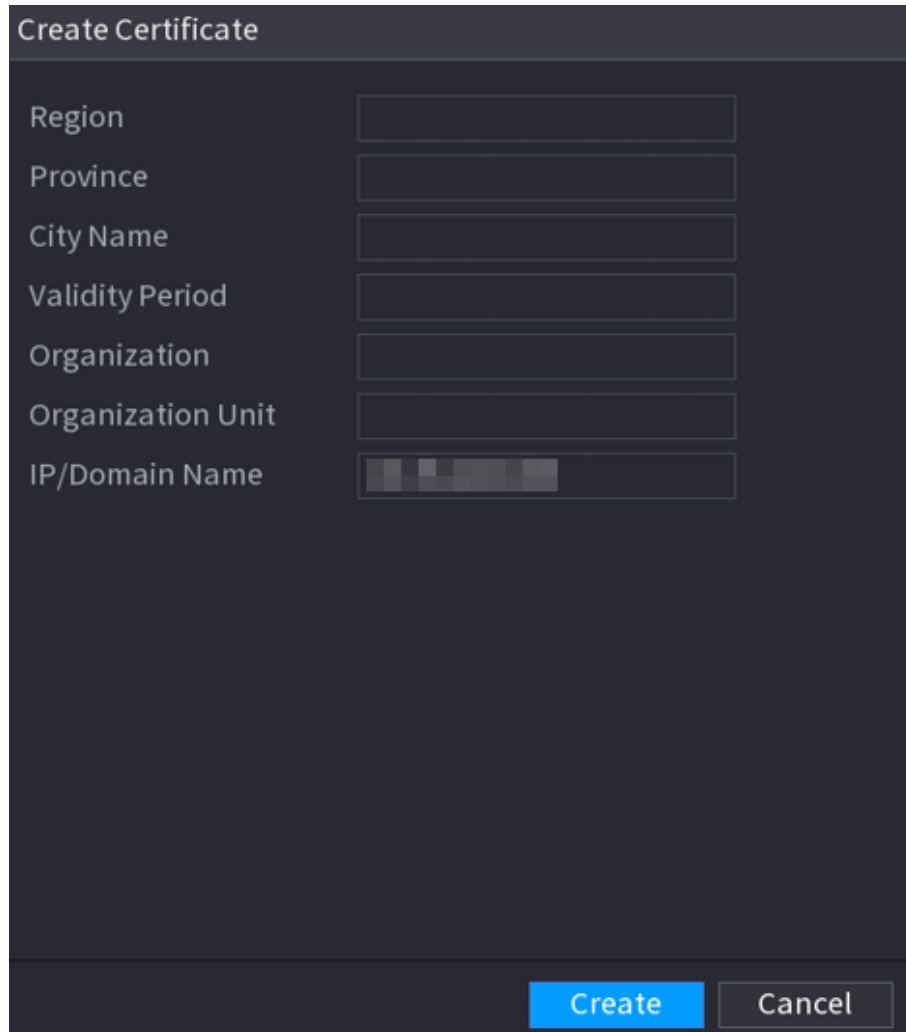

The image shows a dark-themed dialog box titled "Create Certificate". It contains seven input fields stacked vertically, each with a label to its left: "Region", "Province", "City Name", "Validity Period", "Organization", "Organization Unit", and "IP/Domain Name". The "IP/Domain Name" field contains some blurred text. At the bottom right of the dialog, there are two buttons: a blue "Create" button and a grey "Cancel" button.

3. Configure the parameters.
4. Click Create.

## CA Application and Import

Click CA Application and Import and then follow the on-screen instructions to finish CA application and import.

Figure 5-249 CA application and import

**CA Application and Import**

Procedure:

Step 1: Select 'Create Certificate Request' to generate a certificate request file.

Step 2: Submit the certificate request file to a third-party CA institution to apply for a certificate.

Step 3: Select 'Import Certificate' and then import the CA certificate issued by the third-party institution.

Type Create Certificate ... Import Certificate

Region

Province

City Name

Validity Period

Organization

Organization Unit

IP/Domain Name

Create
Cancel

## Import Third-Party Certificate

1. Click Import Third-Party Certificate
2. Configure the parameters.

Table 5-73 Parameters for importing third-party certificate

Parameter	Description
Path	Click Browse to find the third-party certificate path on the USB drive.
Private Key	Click Browse to find the third-party certificate private key on the USB drive.
Private Key Password	Input the private key password.

3. Click Create.

## 5.14.4.2 Trusted CA Certificate

### Procedure

- Step 1** Select Main Menu > SECURITY > CA Certificate > Trusted CA Certificate.  
**Step 2** Click Install Trusted Certificate.

Figure 5-250 Create certificate

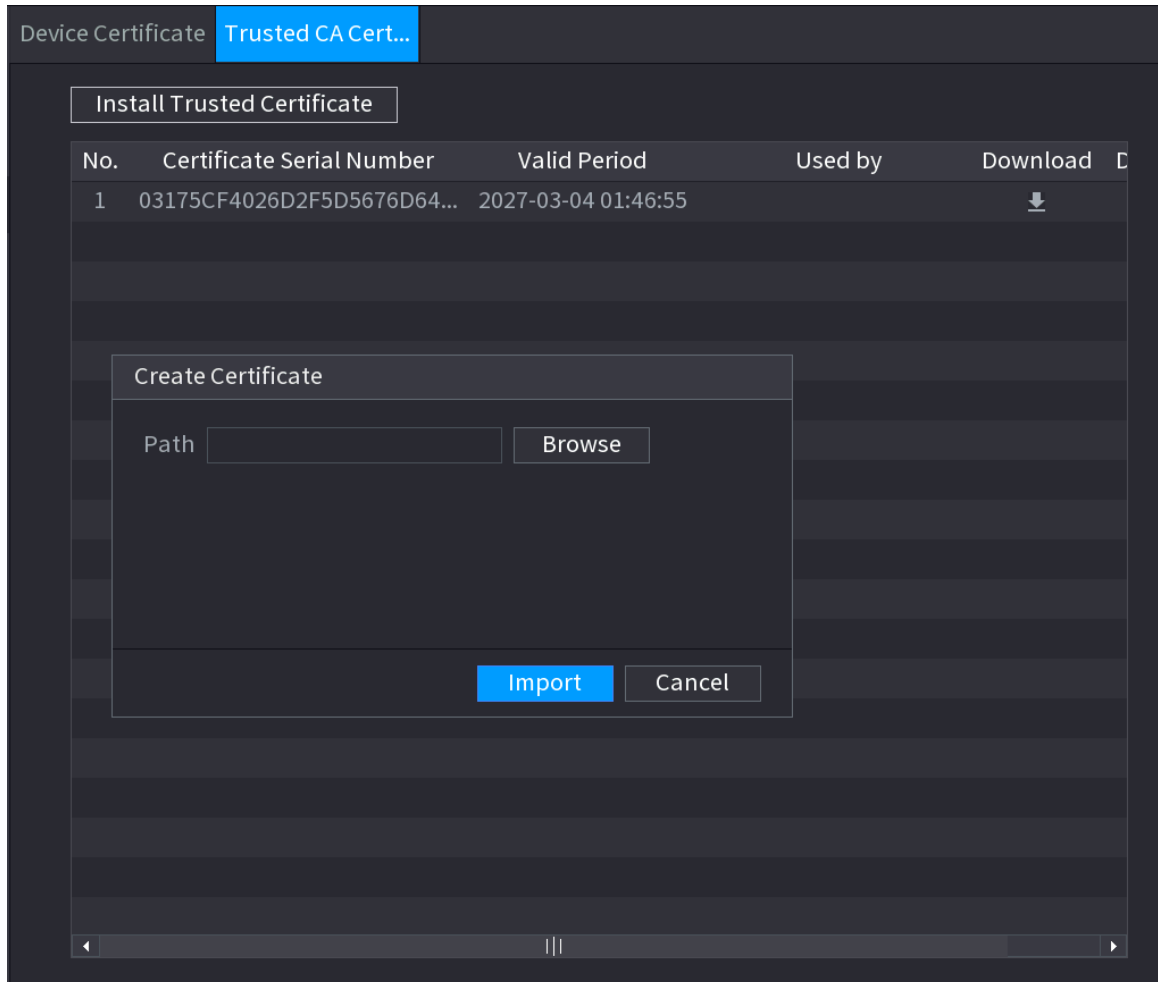

- Step 3** Click Browse to select the certificate that you want to install.  
**Step 4** Click Import.

## 5.14.5 Audio/Video Encryption

### Background Information

The Device supports audio and video encryption during data transmission.

### Procedure

- Step 1** Select Main Menu > SECURITY > AUDIO/VIDEO ENCRYPTION > Audio/Video Transmission.

Figure 5-251 Audio and video transmission

Audio/Video Tr...

**Private Protocol**

Enable  Stream frame is encrypted by using private protocol before transmission.

Encryption Type AES256-OFB

Update Period of S... 12 Hour

---

**RTSP over TLS**

Enable  RTSP stream is encrypted by using TLS tunnel before transmission.

Select a device certificate Certificate Management

No.	Certificate Serial Number	Validity Period	User	Issued by
✓ 1	E...	C... 2049-10-18 14:33:07	172.8.2.22	NVR

**Step 2** Configure parameters.

Table 5-74 Audio and video transmission parameters

Area	Parameter	Description
Private Protocol	Enable	Enables stream frame encryption by using private protocol. There might be safety risk if this service is disabled.
	Encryption Type	Use the default setting.
	Update Period of Secret Key	Secret key update period. Value range: 0–720 hours. 0 means never update the secret key. Default value: 12.
RTSP over TLS	Enable	Enables RTSP stream encryption by using TLS. There might be safety risk if this service is disabled.
	Select a device certificate	Select a device certificate for RTSP over TLS.
	Certificate Management	For details about certificate management, see "5.14.4.1 Device Certificate".

**Step 3** Click Apply.

## 5.14.6 Security Warning

### 5.14.6.1 Security Exception

#### Background Information

The Device gives warnings to the user when a security exception occurs.

#### Procedure

**Step 1** Select Main Menu > SECURITY > Security Warning > Security Exception.

Figure 5-252 Security exception

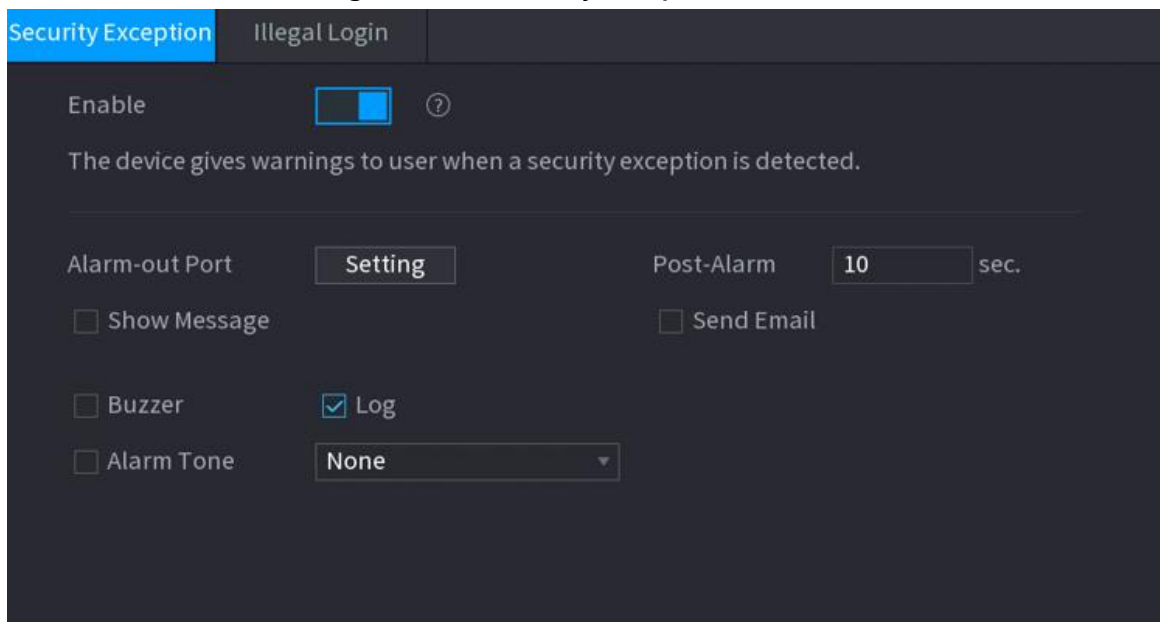

**Step 2** Click  to enable the function.



Click  to view the list of security exception events.

**Step 3** Configure alarm linkage actions. For details, see [Step 7](#).

**Step 4** Click Apply.

### 5.14.6.2 Illegal Login

#### Procedure

**Step 1** Select Main Menu > SECURITY > Security Warning > Illegal Login.

Figure 5-253 Illegal login

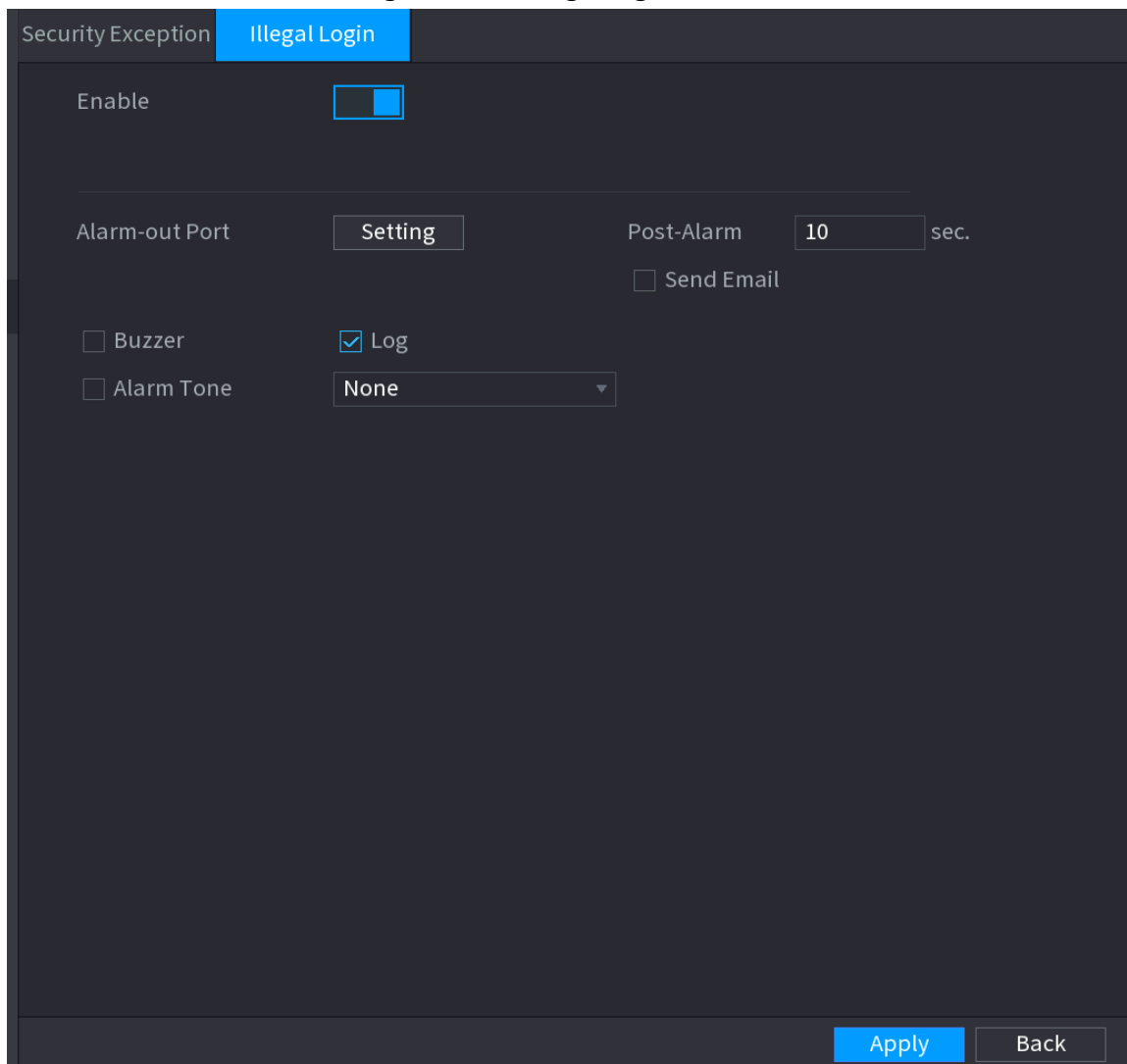

Security Exception    **Illegal Login**

Enable

Alarm-out Port     Post-Alarm  sec.

Buzzer     Log

Alarm Tone   

Send Email

**Step 2** Click  to enable the function.

**Step 3** Configure alarm linkage actions. For details, see [Step7](#).

**Step 4** Click Apply.

## 5.15 System

### 5.15.1 General Settings

You can set NVR basic information such as system date and holiday.

#### 5.15.1.1 General

##### Background Information

You can set device basic information such as device name, and serial number.

## Procedure

**Step 1** Select Main Menu > SYSTEM > General > Basic.

Figure 5-254 Basic settings

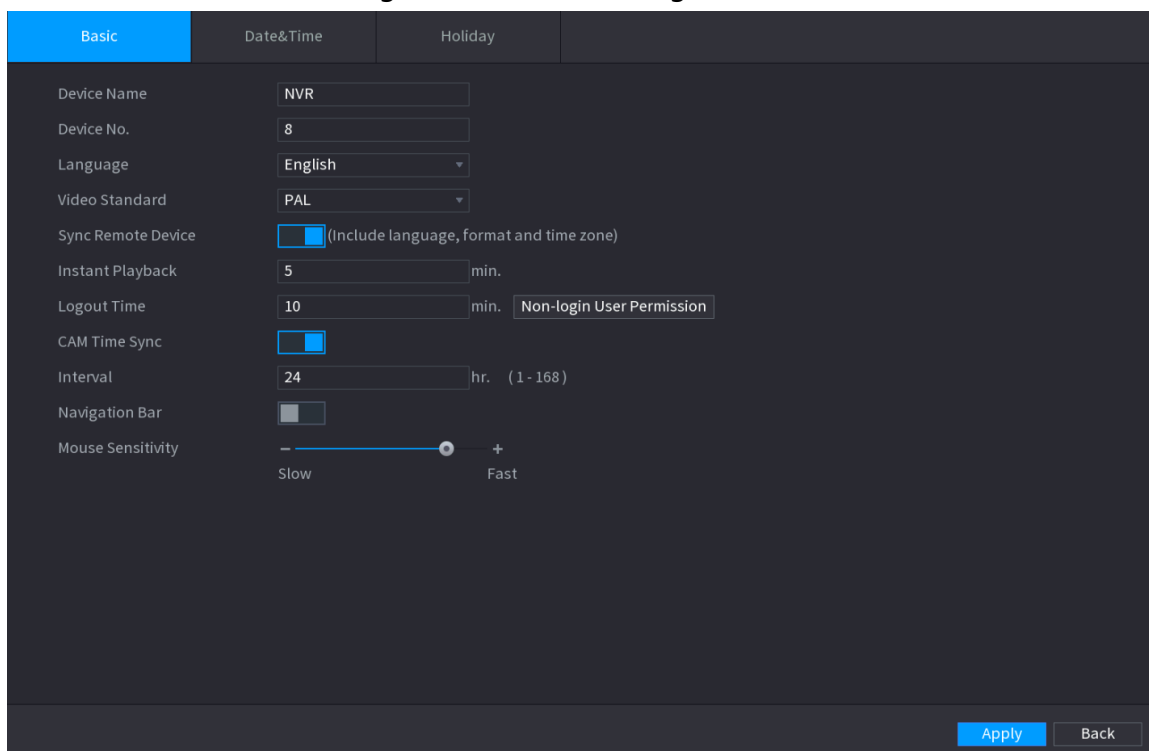

Parameter	Value
Device Name	NVR
Device No.	8
Language	English
Video Standard	PAL
Sync Remote Device	<input checked="" type="checkbox"/> (Include language, format and time zone)
Instant Playback	5 min.
Logout Time	10 min. <span>Non-login User Permission</span>
CAM Time Sync	<input checked="" type="checkbox"/>
Interval	24 hr. (1 - 168)
Navigation Bar	<input type="checkbox"/>
Mouse Sensitivity	Slider (Slow to Fast)

**Step 2** Set parameters.

Table 5-75 Basic parameters

Parameter	Description
Device Name	Enter the Device name.
Device No.	Enter a number for the Device.
Language	Select a language for the Device system.
Video Standard	Select PAL or NTSC as needed.
Sync Remote Device	Enable this function; the NVR can synchronize information with the remote device such as Language, video standard and time zone.
Instant Playback	In the Instant Play box, enter the time length for playing back the recorded video. The value ranges from 5 to 60. On the live view control bar, click the instant playback button to play back the recorded video within the configured time.



Parameter	Description
Logout Time	<p>Enter the standby time for the Device. The Device automatically logs out when it is not working in the configured period. You need to login the Device again.</p> <p>The value ranges from 0 to 60. 0 indicates there is not standby time for the Device.</p> <p>Click Monitor Channel(s) when logout. You can select the channels that you want to continue monitoring when you logged out.</p>
CAM Time Sync	Syncs the Device time with IP camera.
Interval	Enter the interval for time sync.
Logout Time	You can set auto logout interval once login user remains inactive for a specified time. Value ranges from 0 to 60 minutes.
Navigation Bar	Enable the navigation bar. When you click on the live view screen, the navigation bar is displayed.
Mouse Sensitivity	<p>Adjust the speed of double-click by moving the slider.</p> <p>The bigger the value is, the faster the speed is.</p>

**Step 3** Click Apply button to save settings.

### 5.15.1.2 Date and Time

#### Background Information

You can set device time. You can enable NTP (Network Time Protocol) function so that the device can sync time with the NTP server.

You can also configure date and time settings by selecting Main Menu > SYSTEM > General > Date&Time.

#### Procedure

**Step 1** Click Date&Time tab.

Figure 5-255 Date and time

System Time	2020 -02 -24 09 :45 :02
Time Zone	(UTC+08:00) Beijing, Chongqing, Hong Kong, ... <span>Save</span>
Date Format	YYYY MM DD
Date Separator	-
Time Format	24-Hour
DST	<input type="checkbox"/>
Type	<input checked="" type="radio"/> Date <input type="radio"/> Week
Start Time	Jan 1 00 :00
End Time	Jan 2 00 :00
NTP	<input type="checkbox"/>
Server Address	time.windows.com <span>Manual Update</span>
Port	123
Interval	60 min.

**Step 2** Configure the settings for date and time parameters.

Table 5-76 Data and time parameters

Parameter	Description
System Time	In the System Time box, enter time for the system. Click the time zone list, you can select a time zone for the system, and the time in adjust automatically.  Do not change the system time randomly; otherwise the recorded video cannot be searched. It is recommended to avoid the recording period or stop recording first before you change the system time.
Time Zone	In the Time Zone list, select a time zone for the system.
Date Format	In the Date Format list, select a date format for the system.
Date Separator	In the Date Separator list, select a separator style for the date.
Time Format	In the Time Format list, select 12-HOUR or 24-HOUR for the time display style.
DST	Enable the Daylight Saving Time function. Click Week or Date.
Start Time	Configure the start time and end time for the DST.
End Time	

Parameter	Description
NTP	Enable the NTP function to sync the Device time with the NTP server.  If NTP is enabled, device time will be automatically synchronized with server.
Server Address	In the Server Address box, enter the IP address or domain name of the corresponding NTP server. Click Manual Update, the Device starts syncing with the server immediately.
Port	The system supports TCP protocol only and the default setting is 123.
Interval	In the Interval box, enter the amount of time that you want the Device to sync time with the NTP server. The value ranges from 0 to 65535.

Step 3 Click Next to save settings.

### 5.15.1.3 Holiday

#### Background Information

Here you can add, edit, and delete holiday. After you successfully set holiday information, you can view holiday item on the record and snapshot period.

You can also configure holiday settings by selecting Main Menu > SYSTEM > General > Holiday.

#### Procedure

Step 1 Click Next.

Figure 5-256 Holiday

0	Status	Name	Date	Duration	Operation

**Step 2** Click Add Holidays.

Figure 5-257 Add holidays

Add

Name

Effective Mode  Once  Always

Period  Date  Week

Start Time

End Time

Add More



**Step 3** Set holiday name, repeat mode and holiday mode.



Click Add more to add new holiday information.

**Step 4** Click Add, you can add current holiday to the list.



- Click the drop-down list of the state; you can enable/disable holiday date.
- Click  to change the holiday information. Click  to delete current date.

**Step 5** Click Next to save settings.

## 5.15.2 Serial Port

### Background Information

After setting RS-232 parameters, the NVR can use the COM port to connect to other device to debug and operate.

### Procedure

**Step 1** Select MAnalytics+N MENU > SYSTEM > Serial Port.

Figure 5-258 Serial port

Function	Console
Baud Rate	115200
Data Bits	8
Stop Bits	1
Check	None

**Step 2** Configure parameters.

Table 5-77 Serial port parameters

Parameter	Description
Function	Select serial port control protocol. <ul style="list-style-type: none"> <li>• Console: Upgrade the program and debug with the console and mini terminal software.</li> <li>• Keyboard: Control this Device with special keyboard.</li> <li>• Adapter: Connect with PC directly for transparent transmission of data.</li> <li>• Protocol COM: Configure the function to protocol COM, in order to overlay card number.</li> <li>• PTZ Matrix: Connect matrix control</li> </ul>  Different series products support different RS-232 functions.
Baud Rate	Select baud rate, which is 115200 by default.
Data Bits	It ranges from 5 to 8, which is 8 by default.
Stop Bits	It includes 1 and 2.
Parity	It includes none, odd, even, mark and null.

**Step 3** Click Apply.

## 5.16 Output and Display

### 5.16.1 Display

#### Background Information

You can configure the display effect such as displaying time title and channel title, adjusting image transparency, and selecting the resolution.

#### Procedure

**Step 1** Select Main Menu > DISPLAY > Display.

Figure 5-259 Display

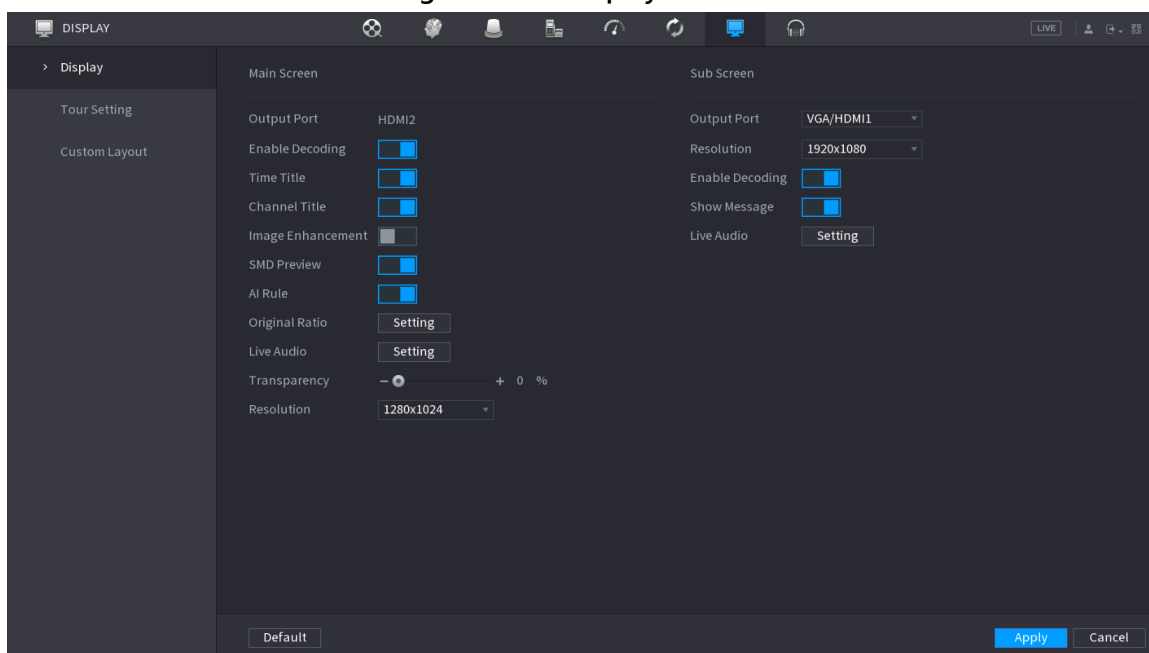

**Step 2** Configure the parameters.

Table 5-78 Display parameters

Parameter	Description
Main Screen/Sub Screen	Configure the output port format of both screens. <ul style="list-style-type: none"> <li>• When sub screen is disabled, the format of main screen is HDMI/VGA simultaneous output.</li> <li>• When sub screen is enabled, the format of main screen and sub screen are non-simultaneous outputs.                             <ul style="list-style-type: none"> <li>◇ When output port of sub screen is set to HDMI, the output port of main screen is set to VGA by the device.</li> <li>◇ When output port of sub screen is set to VGA, the output port of main screen is set to HDMI by the device.</li> </ul> </li> </ul>
Enable Decoding	After it is enabled, the device can normally decode.
Time Title/Channel Title	Select the checkbox and the date and time of the system will be displayed in the preview screen.
Transparency	Set the transparency of the local menu of the NVR device. The higher the transparency, the more transparent the local menu.
Time Title/Channel Title	Select the checkbox and the date and time of the system will be displayed in the preview screen.
Image Enhancement	Select the checkbox to optimize the preview image edges.
SMD Preview	Select the checkbox to display the SMD previews in the live view interface.

Parameter	Description
Analytics+ Rule	Select the checkbox to display the Analytics+ rules in the live view interface.  This function is for some series products only.
Original Ratio	Click Setting and select the channel to restore the corresponding channel image to the original scale.
Live Audio	Configure audio input on live view. You can select Audio 1, Audio 2, and Mixing. For example, if you select Audio 1 for D1 channel, the sound of audio input port 1 of camera is playing. If you select Mixing, the sound of all audio input ports are playing.
Resolution	Support 1920×1080, 1280×1024(default), 1280×720.

Step 3 Click Apply.

## 5.16.2 Tour

### Background Information

You can configure a tour of selected channels to repeat playing videos. The videos display in turn according to the channel group configured in tour settings. The system displays one channel group for a certain period and then automatically changes to the next channel group.

### Procedure

Step 1 Select DISPLAY > Tour Setting > Main Screen.



Figure 5-260 Tour

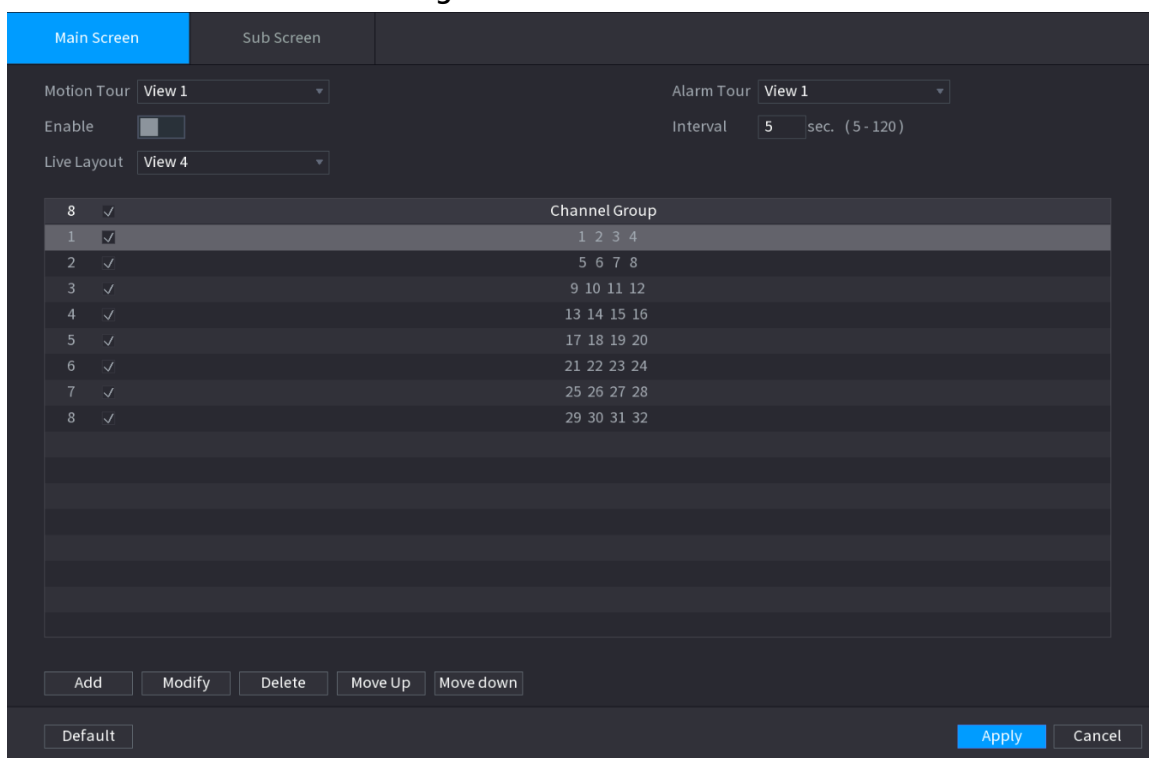

- On the top right of the live view screen, use the left mouse button or press Shift to switch between (image switching is allowed) and (image switching is not allowed) to turn on/off the tour function.
- On the navigation bar, click to enable the tour and click to disable it.

**Step 2** Configure the tour setting parameters.

Table 5-79 Tour parameters

Parameter	Description
Enable Tour	Enable tour function.
Interval	Enter the amount of time that you want each channel group displays on the screen. The value ranges from 5 seconds to 120 seconds, and the default value is 5 seconds.
Motion Tour, Alarm Tour	Select the View 1 or View 8 for Motion Tour and Alarm Tour (system alarm events).
Live Layout	In the Live Layout list, select View 1, View 4, View 8, or other modes that are supported by the Device.

Parameter	Description
Channel Group	<p>Display all channel groups under the current Window Split setting.</p> <ul style="list-style-type: none"> <li>• Add a channel group: Click Add, in the pop-up Add Group channel, select the channels to form a group, and then click Save.</li> <li>• Delete a channel group: Select the checkbox of any channel group, and then click Delete.</li> <li>• Edit a channel group: Select the checkbox of any channel group and then click Modify, or double-click on the group. The Modify Channel Group dialog box is displayed. You can regroup the channels.</li> <li>• Click Move up or Move down to adjust the position of channel group.</li> </ul>

**Step 3** Click Apply to save the settings.

### 5.16.3 Custom Layout

#### Background Information

You can set customized video split mode.



- This function is for some series products. See the actual product for detailed information.
- Device max. supports 5 customized videos.

#### Procedure

**Step 1** Select Main Menu > DISPLAY > Custom Split.

Figure 5-261 Custom split

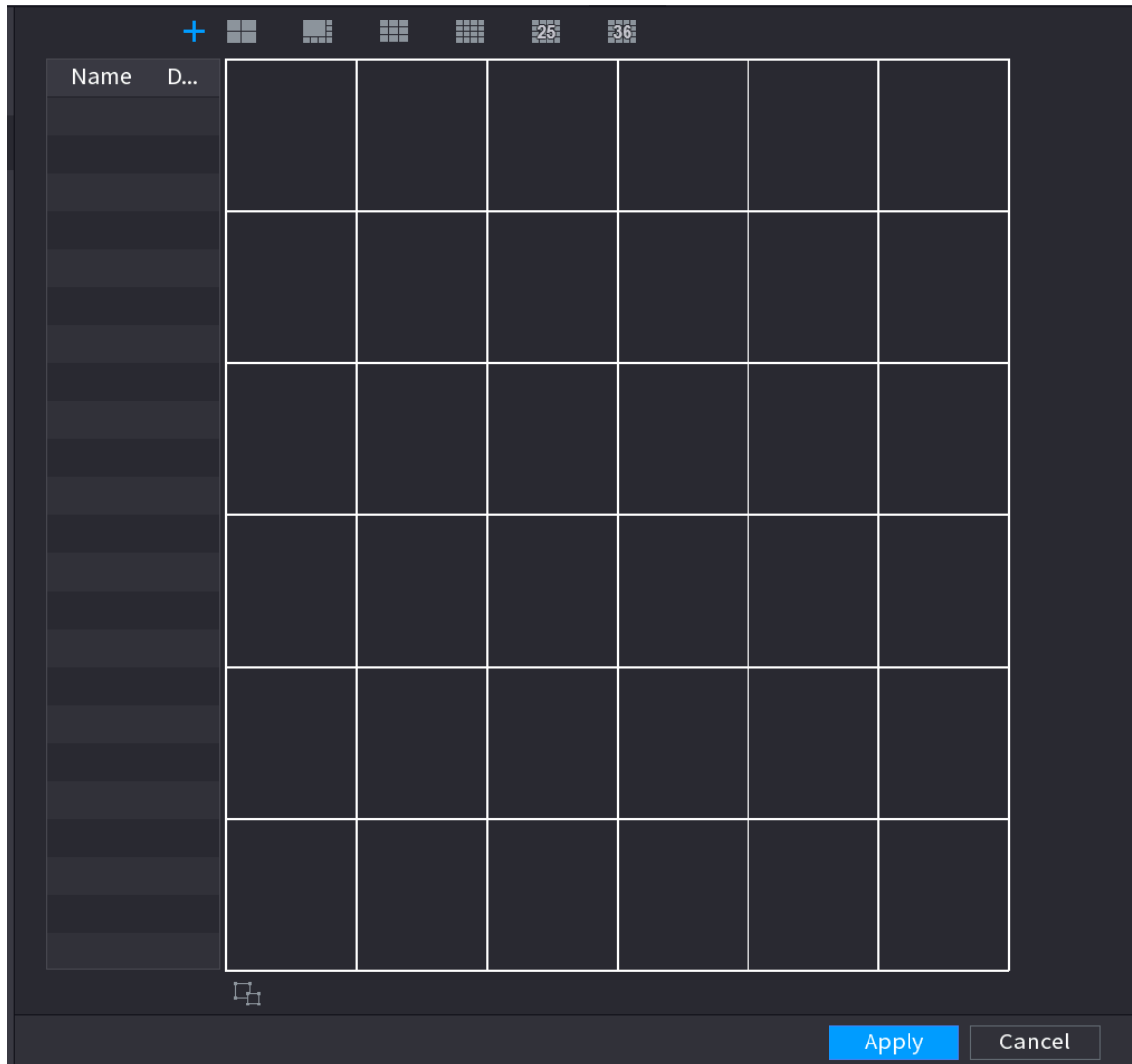

**Step 2** Click **+** and then click **[icons]** to select basic mode.

System adopts the basic window mode as the new window name. For example, if you select the 8 display mode, the default name is Split8.

In regular mode, drag the mouse in the preview frame; you can merge several small windows to one window so that you can get you desired split mode.



- After merge the window, system adopts the remaining window amount as the new name such as Split6.

- Select the window you want to merge (red highlighted), click

to cancel the merge to restore the basic mode.

- Click

to delete the customized window mode.

Figure 5-262 Merged window

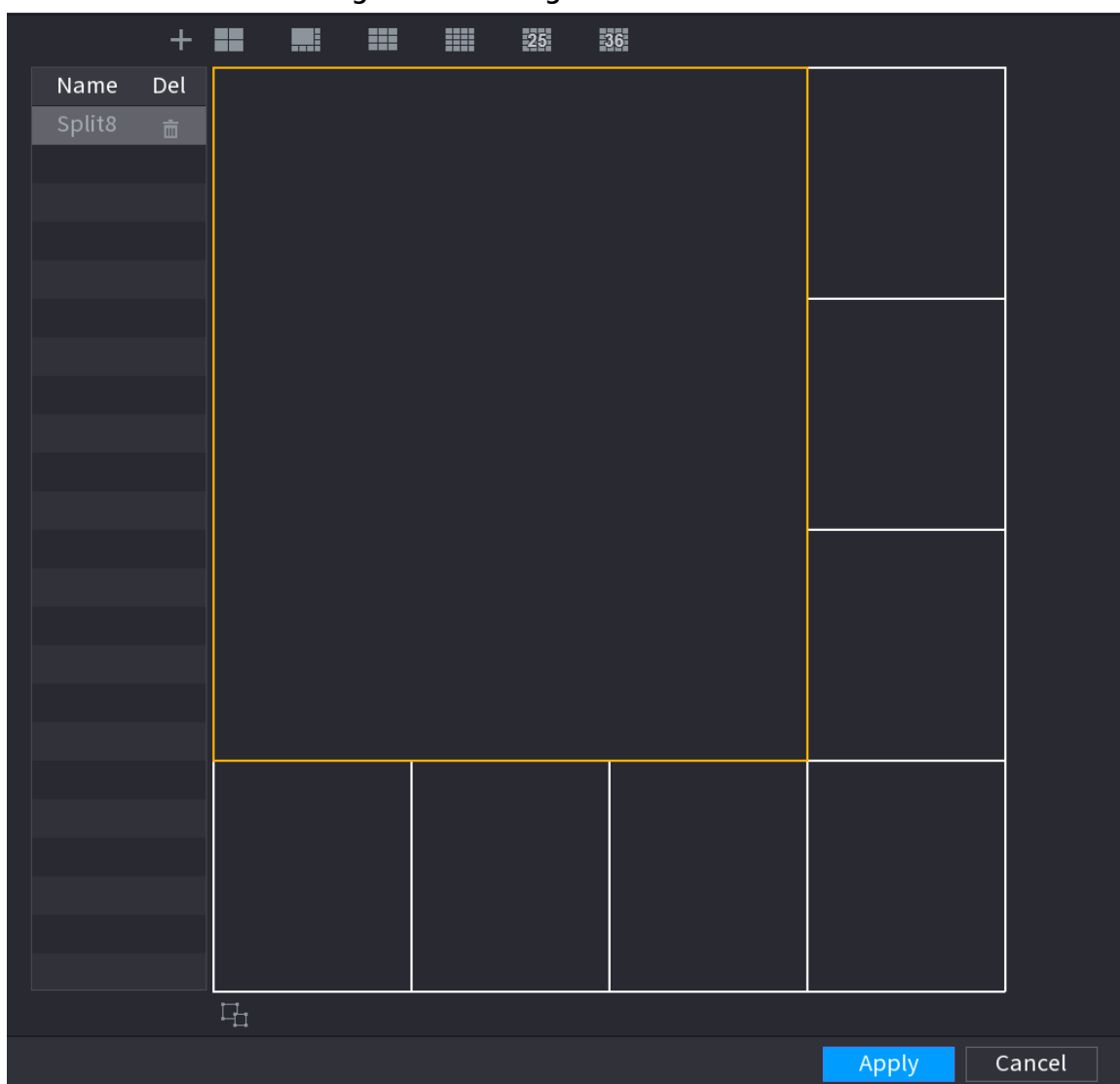

**Step 3** Click Apply to exit.

After the setup, you can go to the preview window, right-click and then select Live Layout to select the custom split layout.

## 5.17 POS

You can connect the Device to the POS (Point of Sale) machine and receive the information from it. This function applies to the scenarios such as supermarket POS machine. After connection is established, the Device can access the POS information and display the overlaid text in the channel window.

### 5.17.1 Settings

#### Procedure



**Step 1** Select Main Menu > POS > POS Setting.

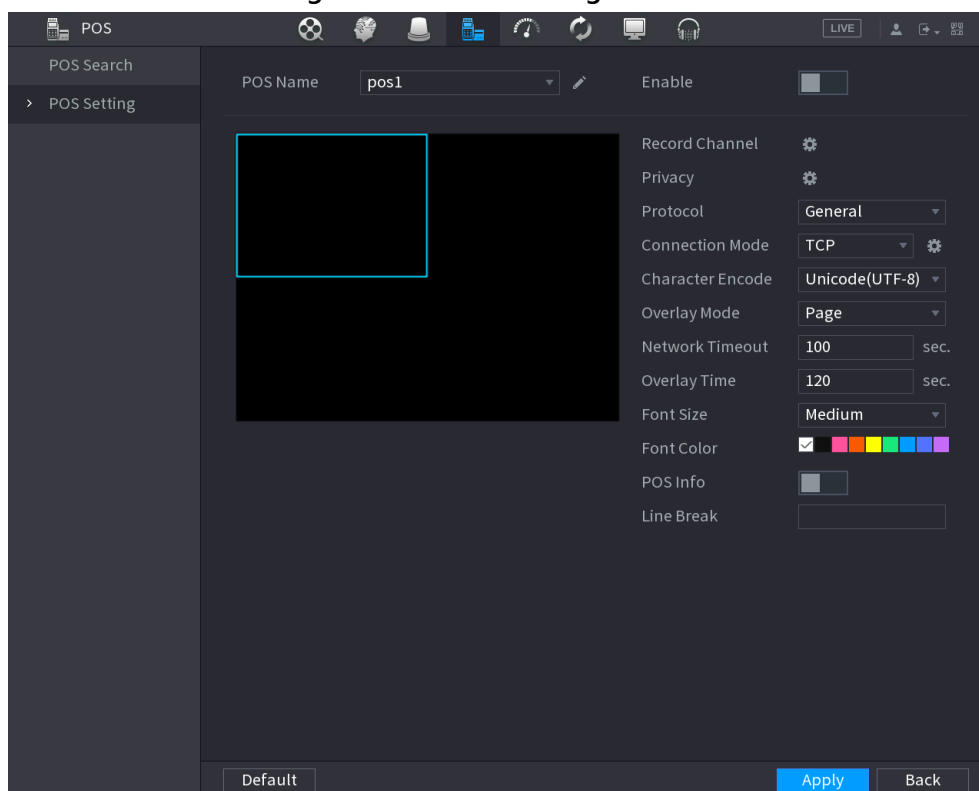

Figure 5-263 POS setting



**Step 2** Configure the POS parameters.

Table 5-80 POS parameters

Parameter	Description
POS Name	<p>In the POS Name list, select the POS machine that you want to configures settings for. Click  to modify the POS name.</p> <p></p> <ul style="list-style-type: none"> <li>The POS name must be unique.</li> <li>You can enter up to 21 Chinese characters or 63 English characters.</li> </ul>

Parameter	Description
Enable	Enable the POS function.
Record Channel	Click  to select a channel to record.
Privacy	Enter the privacy contents.
Protocol	Select a protocol. Different machines correspond to different protocols.
Connection Mode	Select the connection protocol type. Click  , the IP Address window is displayed. In the Source IP box, enter the IP address (the machine that is connected to the Device) that sends messages.
Character Encode	Select a character encoding mode.
Overlay Mode	In the Overlay Mode list, Select Turn or ROLL. <ul style="list-style-type: none"> <li>• Turn: Once the information is at 16 lines, system displays the next page.</li> <li>• ROLL: Once the information is at 16 lines, system rolls one line after another to delete the first line.</li> </ul>  When the local preview mode is in 4-split, the turn/ROLL function is based on 8 lines.
Network time out	When the network is not working correctly and cannot be recovered after the entered timeout limit, the POS information will not display normally. After the network is recovered, the latest POS information will be displayed.
Time Display	Enter the time that how long you want to keep the POS information displaying. For example, enter 5, the POS information disappear from the screen after 5 seconds.
Font Size	Select Small, Medium, or Big as the text size of POS information
Font Color	In the color bar, click to select the color for the text size of POS information.
POS Info	Enable the POS Info function, the POS information displays in the live view/WEB.
Line Break	There is no line delimiter by default. After you set the line delimiter (HEX), the overlay information after the delimiter is displayed in the new line. For example, the line delimiter is F and the overlay information is 123F6789, NVR displays overlay information on the local preview interface and Web as:  123 6789

**Step 3** Click Apply.

### 5.17.1.1 Privacy Setup

#### Procedure

**Step 1** Click  next to Privacy.

Figure 5-264 Privacy

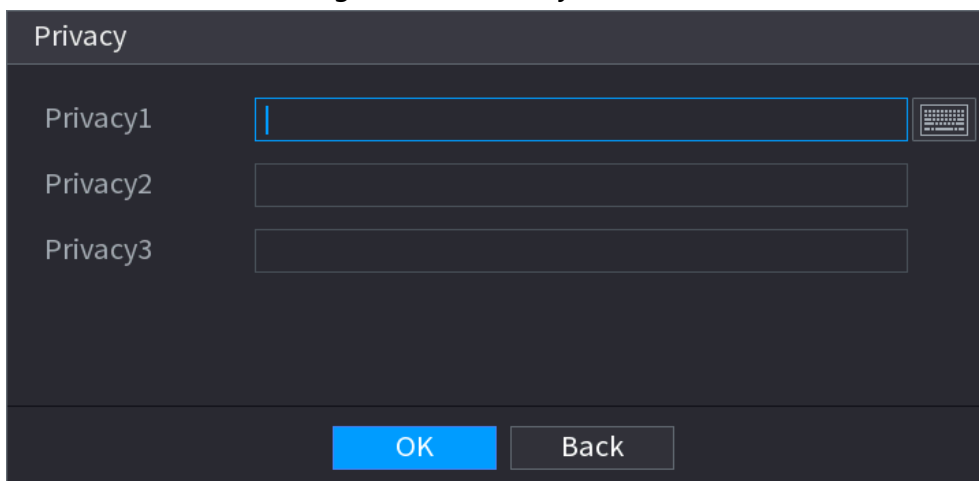

**Step 2** Set privacy information.

**Step 3** Click OK.

### 5.17.1.2 Connection Mode

#### Background Information

Connection type is UDP or TCP.

#### Procedure

**Step 1** Select Connection Mode as UDP, TCP\_CLINET or TCP.

**Step 2** Click .

Figure 5-265 IP address

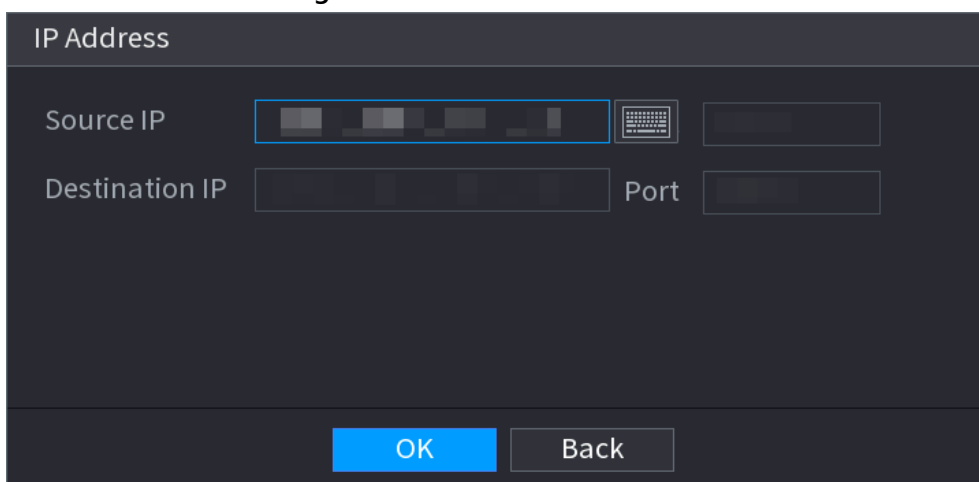

**Step 3** For Source IP and Port, enter the POS IP address and port.

**Step 4** Click OK.

## 5.17.2 Search

### Background Information



The system supports fuzzy search.

### Procedure

**Step 1** Select Main Menu > POS > POS Search.

Figure 5-266 POS search

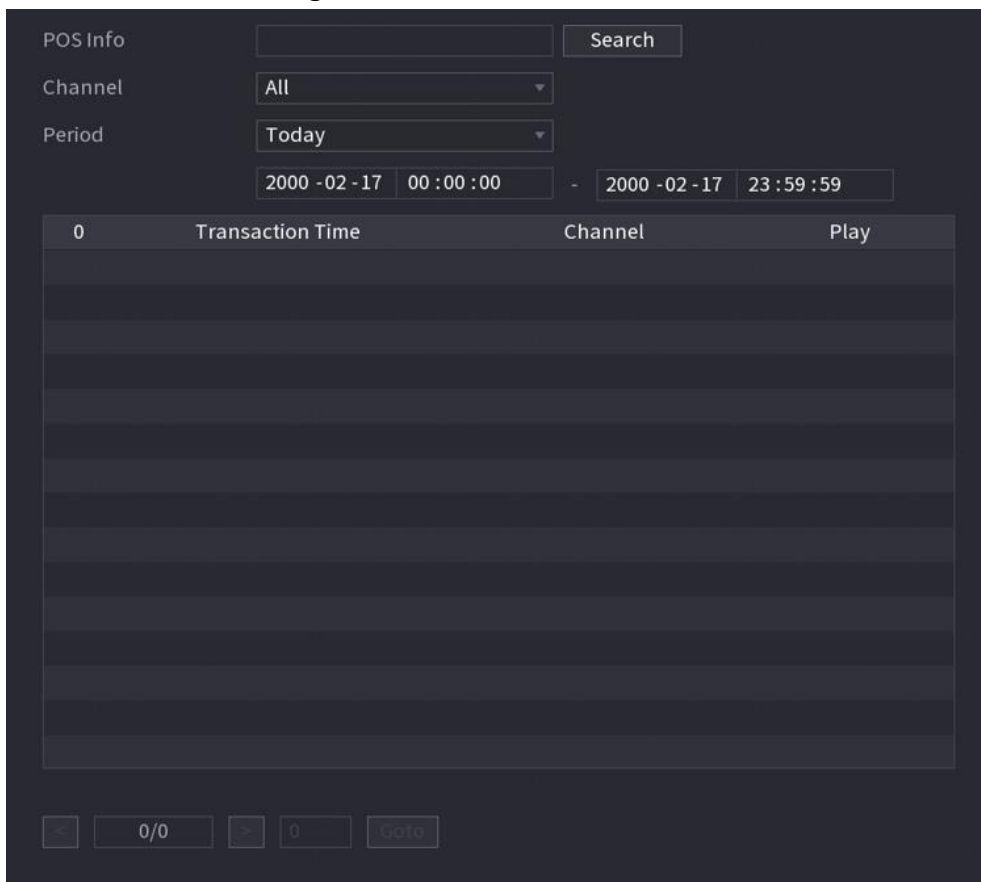

**Step 2** In the POS Search box, enter the information such as transaction number on your receipt, amount, or product name.

**Step 3** In the Start Time box and End Time box, enter the time period that you want to search the POS transaction information.

**Step 4** Click Search.

The searched transaction results display in the table.

## 5.18 Audio

The audio function is to manage audio files and set schedule play function. It is to realize audio broadcast activation function.





Figure 5-268 Add file

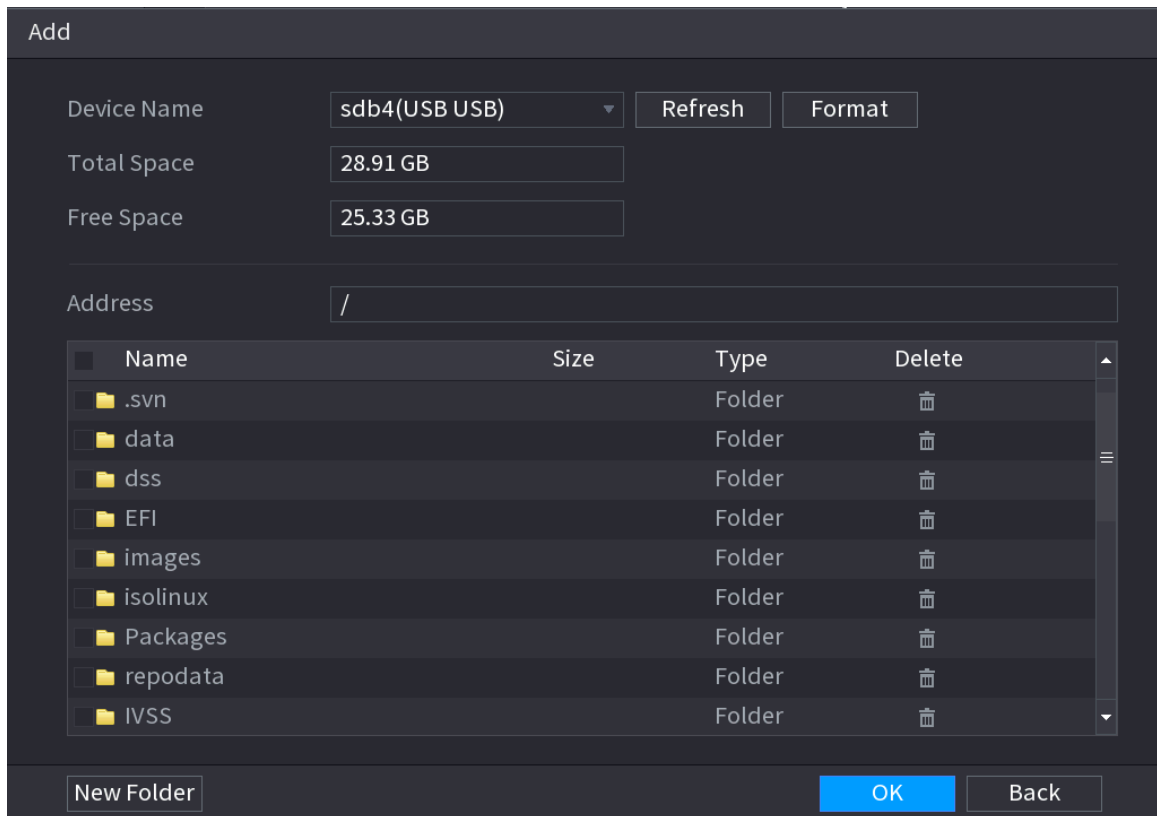

**Step 3** Select the audio file and then click Import.

System supports MP3 and PCM audio format.

**Step 4** Click OK to start importing audio files from the USB storage device.

If the importing is successful, the audio files will display in the File Management page.

## 5.18.2 Audio Play

### Background Information

You can configure the settings to play the audio files during the defined time period.

### Procedure

**Step 1** Select Main Menu > AUDIO > Schedule.

Figure 5-269 Schedule

Period	File Name	Interval	Loop	Outpu...
<input type="checkbox"/> 00 : 00 - 24 : 00	None	60 min.	0	Mic
<input type="checkbox"/> 00 : 00 - 24 : 00	None	60 min.	0	Mic
<input type="checkbox"/> 00 : 00 - 24 : 00	None	60 min.	0	Mic
<input type="checkbox"/> 00 : 00 - 24 : 00	None	60 min.	0	Mic
<input type="checkbox"/> 00 : 00 - 24 : 00	None	60 min.	0	Mic
<input type="checkbox"/> 00 : 00 - 24 : 00	None	60 min.	0	Mic

**Step 2** Configure the parameters.

Table 5-81 Schedule parameters

Parameter	Description
Period	In the Period box, enter the time. Select the checkbox to enable the settings. You can configure up to six periods.
File Name	In the File Name list, select the audio file that you want to play for this configured period.
Interval	In the Interval box, enter the time in minutes for how often you want to repeat the playing.
Loop	Configure how many times you want to repeat the playing in the defined period.
Output	Includes two options: MIC and Audio. It is MIC by default. The MIC function shares the same port with talkback function and the latter has the priority.  Some series products do not have audio port.



- The finish time for audio playing depends on audio file size and the configured interval.
- Playing priority: Alarm event > Audio talk > Trial listening > Schedule audio file.

**Step 3** Click Apply.

### 5.18.3 Broadcast

#### Background Information

System can broadcast to the camera, or broadcast to a channel group.









- On the broadcast interface, click  to change group setup, click  to delete group.
- After complete broadcast setup, on the preview interface and then click  on the navigation bar, device pops up broadcast dialogue box. Select a group name and then click  to begin broadcast.

Figure 5-272 Add group (2)



## 5.19 Operation and Maintenance

### 5.19.1 Log

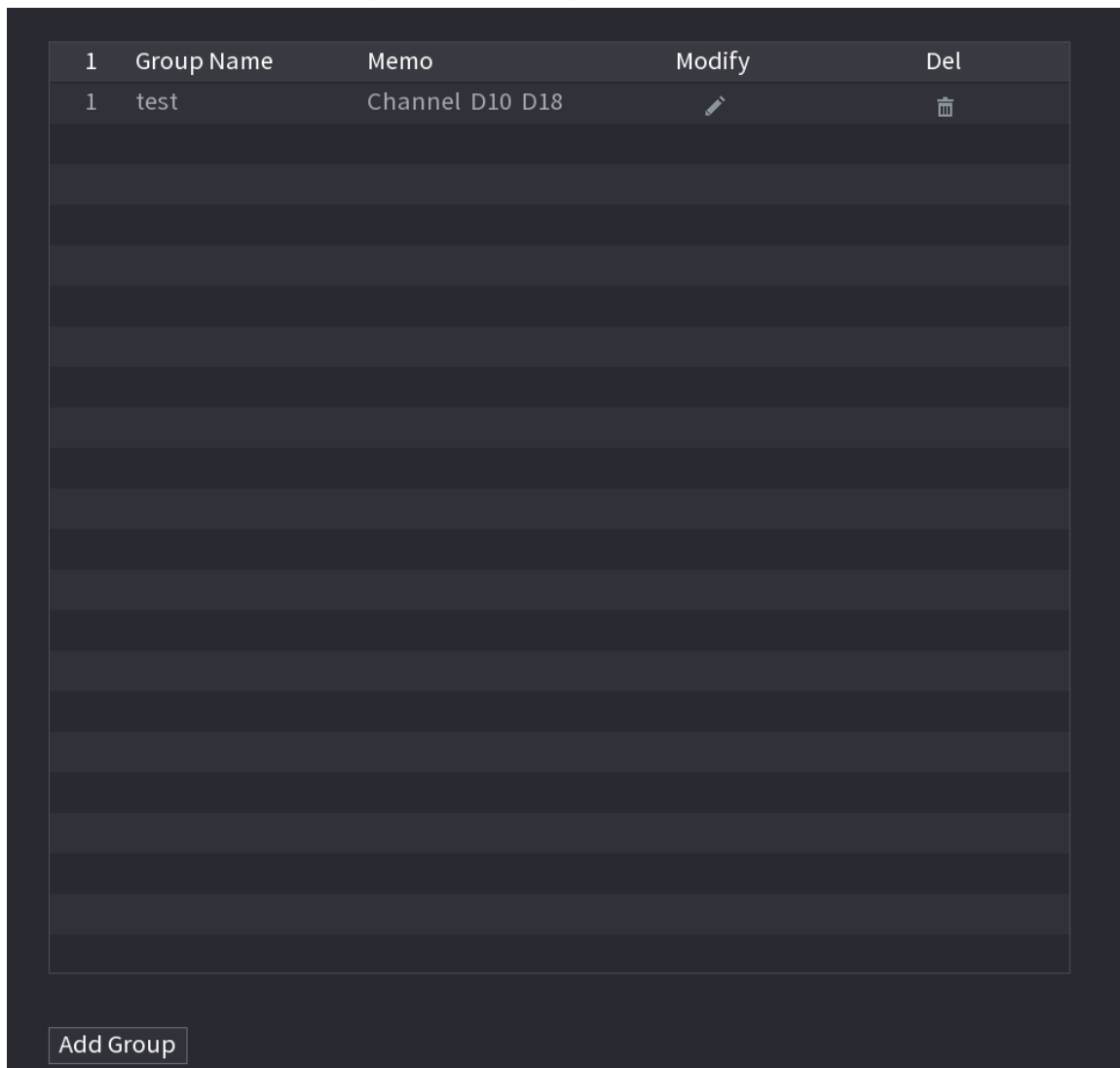
#### Background Information

You can view and search for the log information, or back up log to the USB device.

## Procedure

**Step 1** Select Main Menu > MAnalytics+NTAnalytics+N > Log.

Figure 5-273 Log

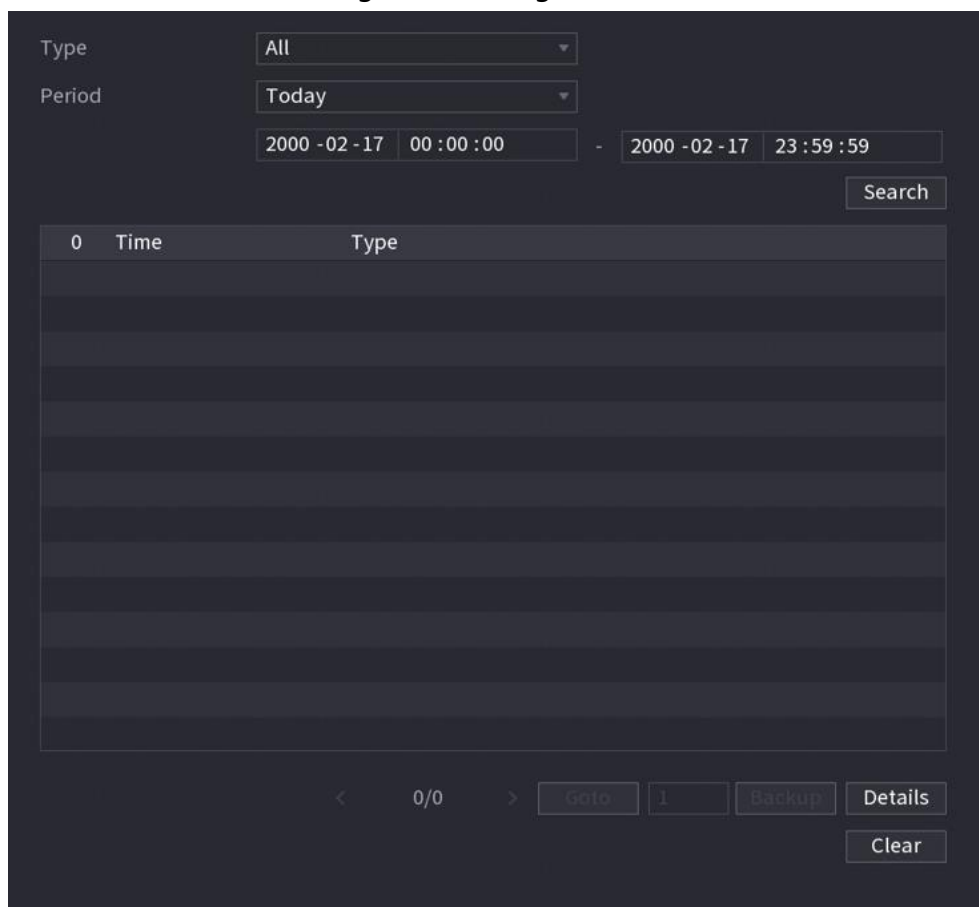

**Step 2** In the Type list, select the log type that you want to view (System, Config, Storage, Record, Account, Clear Log, Playback, and Connection) or select All to view all logs.

**Step 3** Enter the time period to search, and then click Search.  
The search results are displayed.

## Related Operations

- Click Details or double-click the log to view details. Click Next or Previous to view more log information.
- Click Backup to back up the logs to the USB storage device.
- Click Clear to remove all logs.

## 5.19.2 System

### 5.19.2.1 System Version

Select Main Menu > MAnalytics+NTAnalytics+N > System Info > Version.  
You can view NVR version information.

### 5.19.2.2 Analytics+ Algorithm Version

Select Main Menu > MAnalytics+NTAnalytics+N > System Info > Intelligent Algorithm. You can view version information for Analytics+ functions such as face detection, Face Detection+, IVS, and video metadata.

### 5.19.2.3 HDD Info

You can view the HDD quantity, HDD type, total space, free space, status, and S.M.A.R.T information.

Select Main Menu > MAnalytics+NTAnalytics+N > System Info > Disk.

Figure 5-274 Disk information

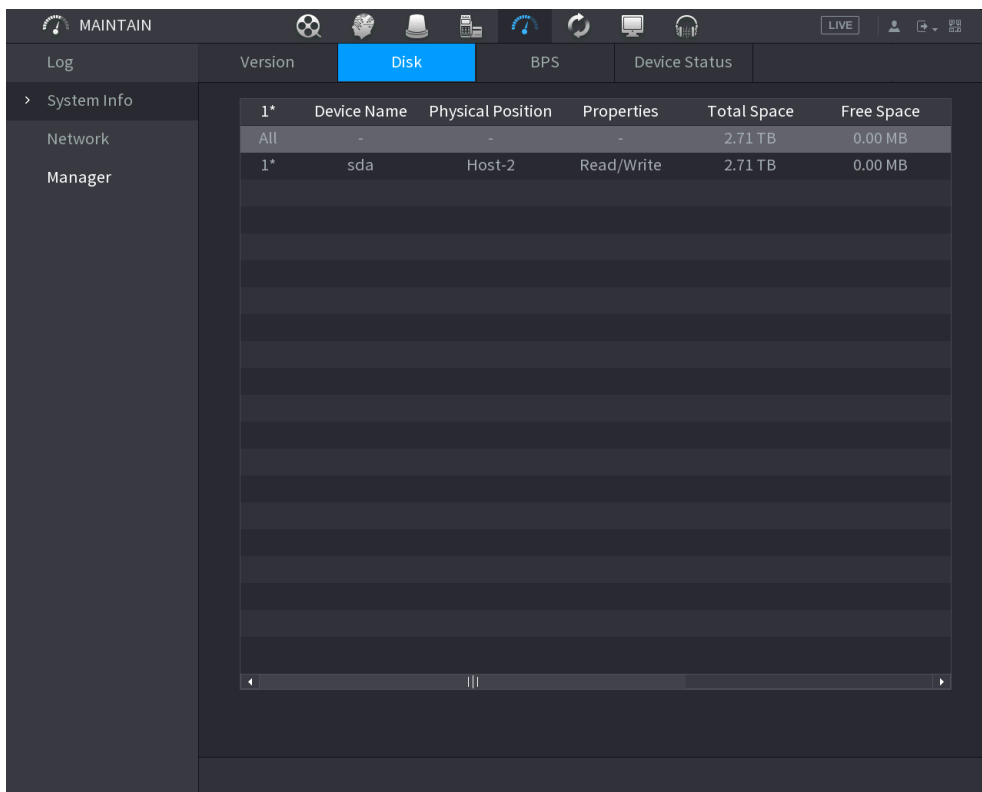

Table 5-82 Disk information

Parameter	Description
No.	Indicates the number of the currently connected HDD. The asterisk (*) means the current working HDD.
Device Name	Indicates name of HDD.
Physical Position	Indicates installation position of HDD.
Properties	Indicates HDD type.
Total Space	Indicates the total capacity of HDD.
Free Space	Indicates the usable capacity of HDD.
Health Status	Indicates the health status of the HDD.

Parameter	Description
S.M.A.R.T	View the S.M.A.R.T reports from HDD detecting.
Status	Indicates the status of the HDD to show if it is working normally.

### 5.19.2.4 BPS

You can view current video bit rate (kb/s) and resolution.

Select Main Menu > MAnalytics+NTAnalytics+N > System Info > BPS.

Figure 5-275 BPS

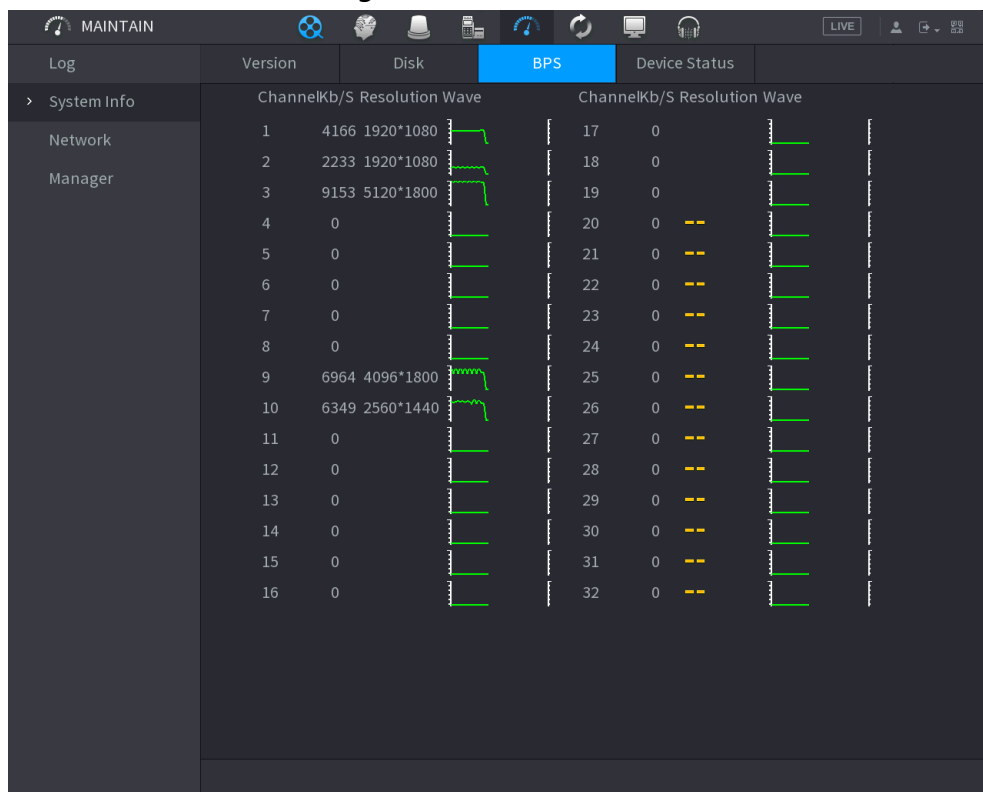

### 5.19.2.5 Device Status

You can view fan running status such as speed, CPU temperature, and memory.

Select Main Menu > MAnalytics+NTAnalytics+N > System Info > Device Status.



Figure 5-276 Device status

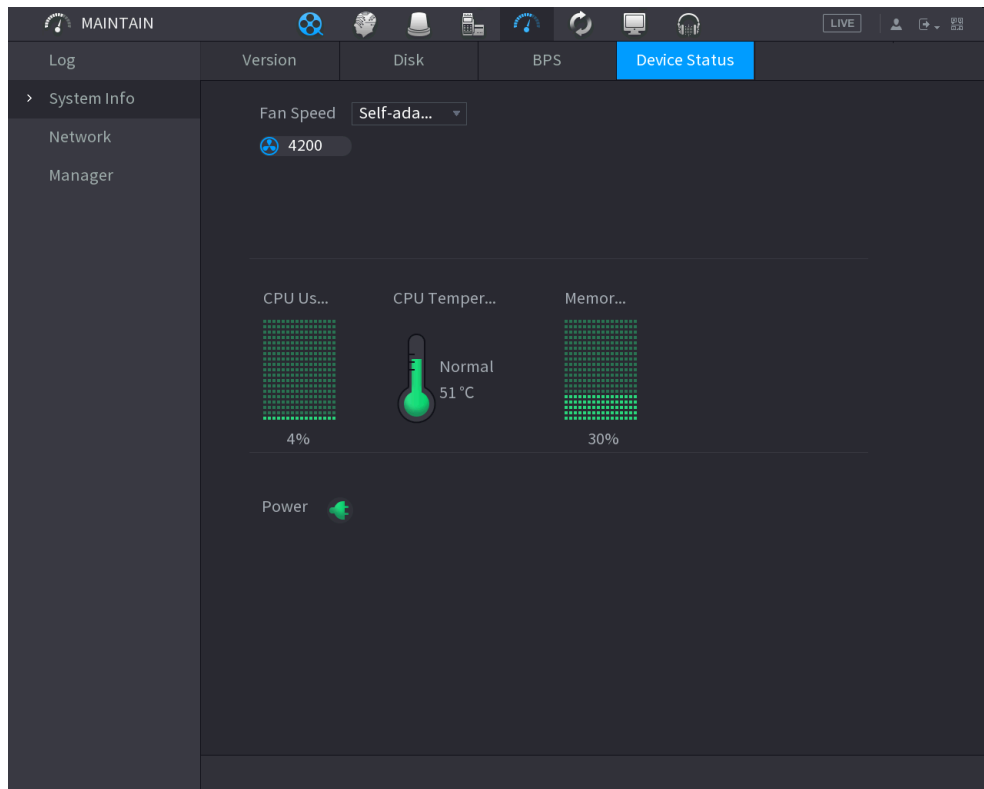

## 5.19.3 Network

### 5.19.3.1 Online User

You can view the online user information or block any user for a period of time. To block an online user, click  and then enter the time that you want to block this user. The maximum value you can set is 65535.

The system detects every 5 seconds to check whether there is any user added or deleted, and update the user list timely.

Select Main Menu > MAnalytics+NTAnalytics+N > Network > Online User.



Figure 5-278 Network load

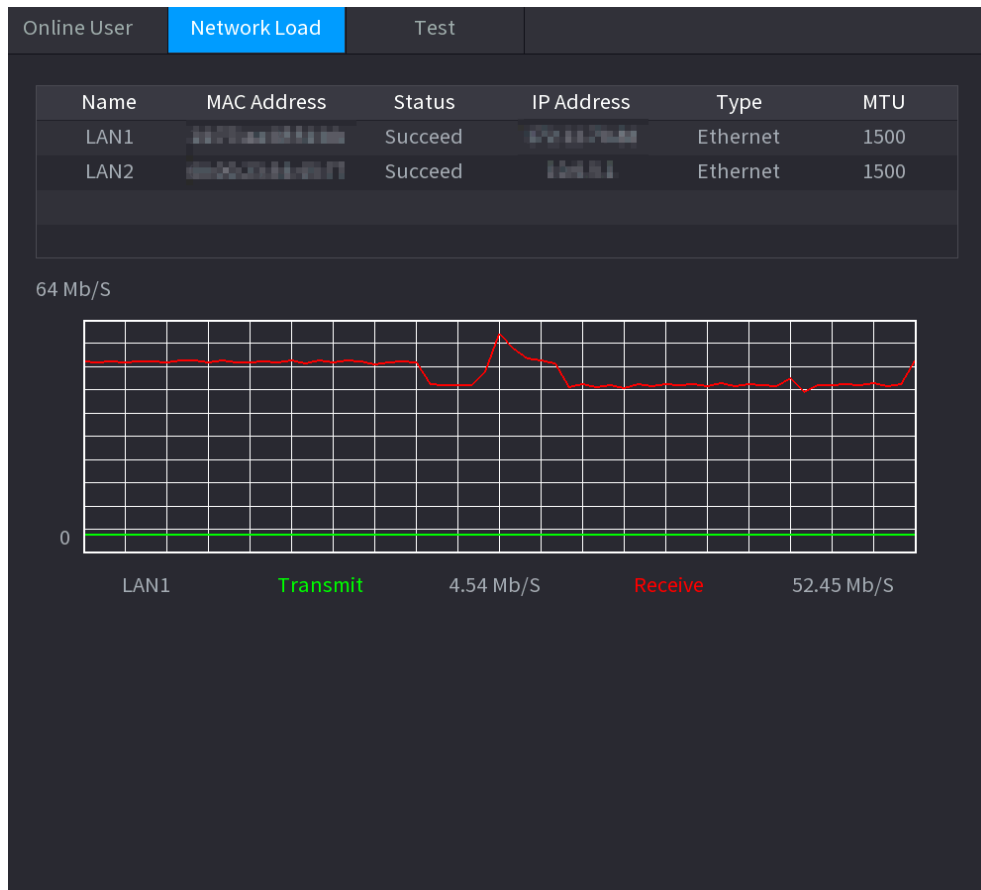

- Step 2** Click the LAN name that you want to view, for example, LAN1.  
The system displays the information of data sending speed and receiving speed.



- System displays LAN1 load by default.
- Only one LAN load can be displayed at one time.

### 5.19.3.3 Network Test

#### Background Information

You can test the network connection status between the Device and other devices.

#### Procedure

- Step 1** Select Main Menu > MAnalytics+NTAnalytics+N > Network > Test.

Figure 5-279 Test

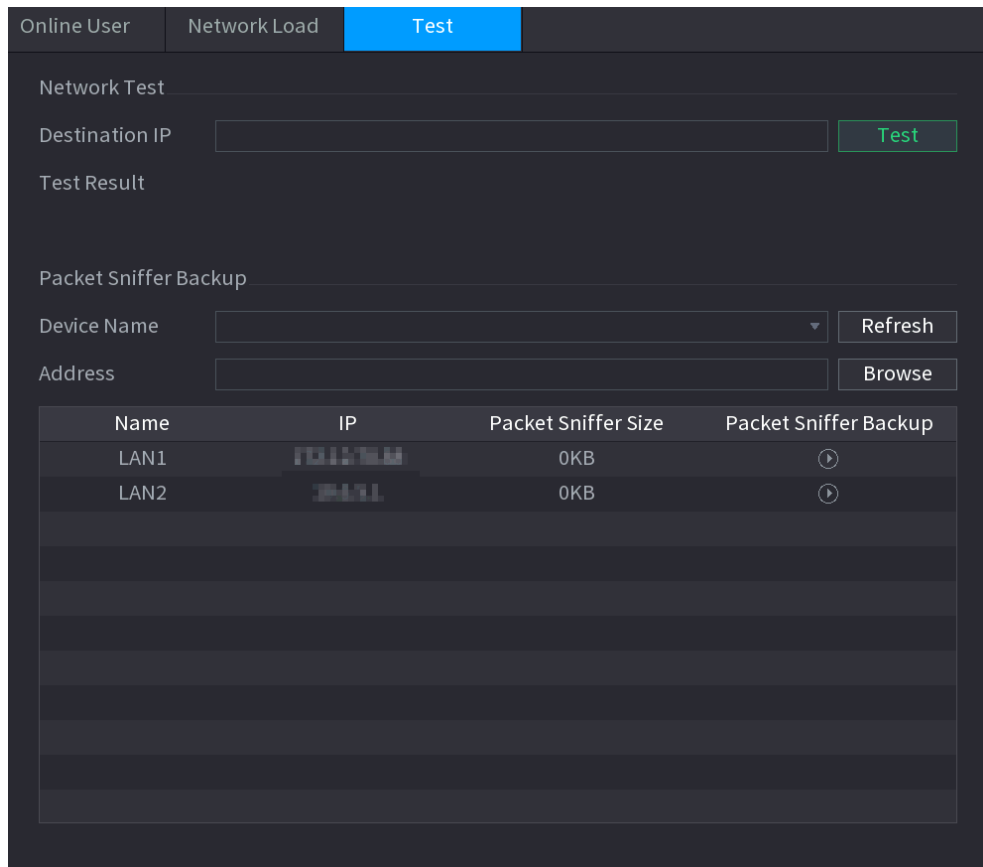

Name	IP	Packet Sniffer Size	Packet Sniffer Backup
LAN1	192.168.1.1	0KB	▶
LAN2	192.168.1.2	0KB	▶

**Step 2** In the Destination IP box, enter the IP address.

**Step 3** Click Test.

After testing is completed, the test result is displayed. You can check the evaluation for average delay, packet loss, and network status.

## 5.19.4 Maintenance and Management

### 5.19.4.1 Device Maintenance

#### Background Information

When the Device has been running for a long time, you can enable the Device to restart automatically at the idle time. You can also enable emergency maintenance.

#### Procedure

**Step 1** Select Main Menu > MAnalytics+NTAnalytics+N > Manager > Maintenance.

Figure 5-280 Maintenance

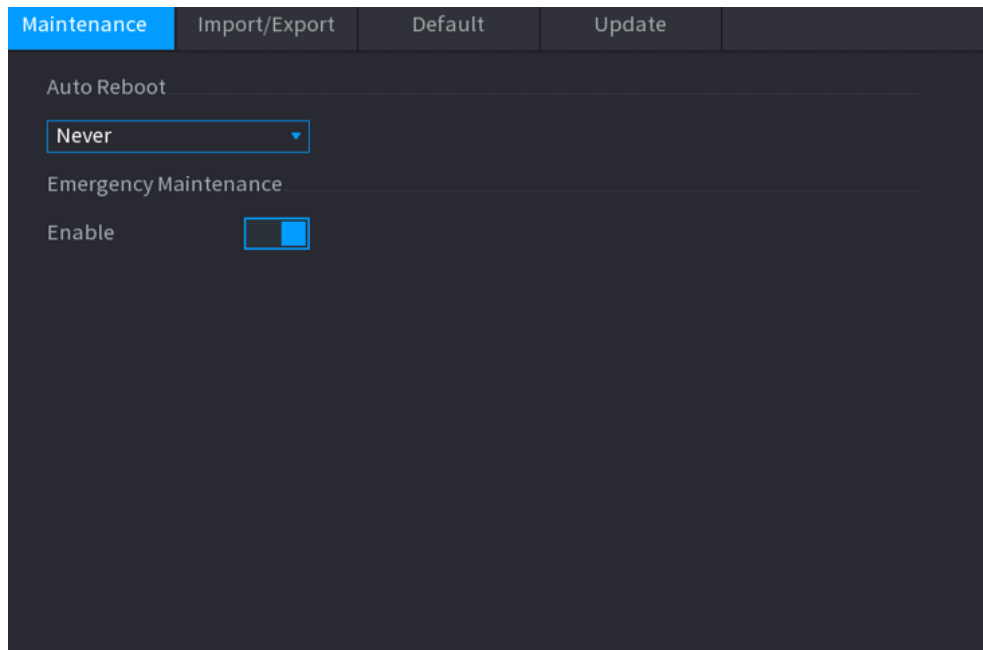

**Step 2** Configure the parameters.

- Auto Reboot: Enable the Device to restart at the idle time.
- Emergency Maintenance: When the Device has an update power outage, running error and other problems, and you cannot log in, then you can use the emergency maintenance function to restart the Device, clear configuration, update the system, and more.

**Step 3** Click Apply.

## 5.19.4.2 Exporting System Settings

### Background Information

You can export or import the Device system settings if there are several Devices that require the same setup.



- The Import/Export interface cannot be opened if the backup operation is ongoing on the other interfaces.
- When you open the Import/Export interface, the system refreshes the devices and sets the current directory as the first root directory.
- Click Format to format the USB storage device.

### Procedure

**Step 1** Select Main Menu > MAnalytics+NTAnalytics+N > Manager > Import/Export.



Figure 5-282 Connected USB device

Maintenance **Import/Export** Default Update

Device Name: sdb4(USB USB) Refresh Format

Total Space: 28.91 GB

Free Space: 25.33 GB

Address: /

Name	Size	Type	Delete
└─ .svn		Folder	🗑
└─ data		Folder	🗑
└─ dss		Folder	🗑
└─ EFI		Folder	🗑
└─ images		Folder	🗑
└─ isolinux		Folder	🗑
└─ Packages		Folder	🗑
└─ repodata		Folder	🗑
└─ IVSS		Folder	🗑
└─ NVR		Folder	🗑
└─ .discinfo	31 B	File	🗑
└─ .treeinfo	338 B	File	🗑
└─ anaconda-ks.cfg	3.1 KB	File	🗑
└─ CentOS_BuildTag	14 B	File	🗑
└─ EULA	212 B	File	🗑

Imported configuration will overwrite previous configuration.

New Folder Import Export

**Step 4** Click Export.

There is a folder under the name style of "Config\_xxxx". Double-click this folder to view the backup files.

### 5.19.4.3 Restoring Defaults

#### 5.19.4.3.1 Restoring Defaults on the Local Interface

#### Background Information



This function is for admin account only.

You can restore the Device to default settings on the local interface.

#### Procedure

**Step 1** Select Main Menu > MAnalytics+NTAnalytics+N > Manager > Default.

Figure 5-283 Default

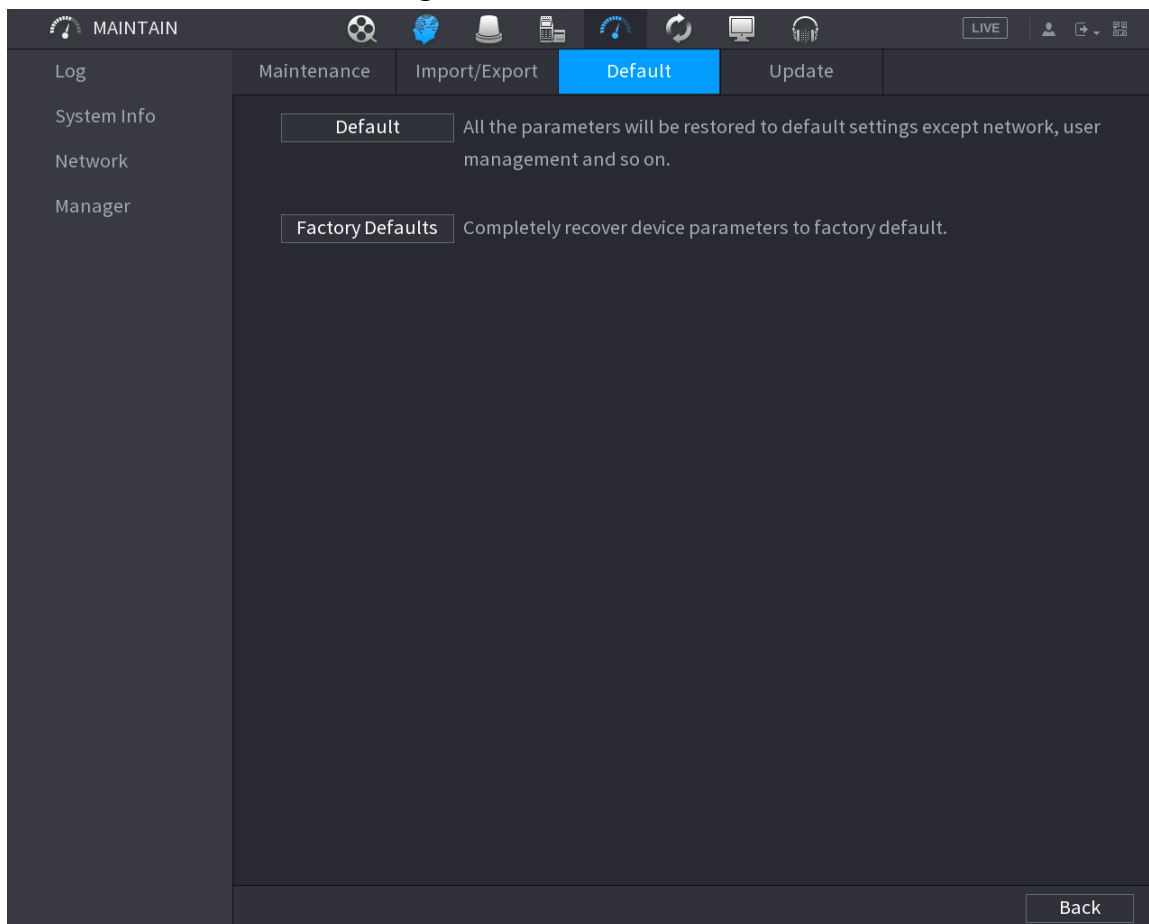

**Step 2** Restore the settings.

- **Default:** Restore all the configurations except network settings and user management to the default..
- **Factory Default:** Restore all the configurations to the factory default settings.

### 5.19.4.3.2 Resetting Device through the Reset Button

#### Background Information

You can use the reset button on the mainboard to reset the Device to the factory default settings.



The reset button is available on select models.



After resetting, all the configurations will be lost.

#### Procedure

- Step 1** Disconnect the Device from power source, and then remove the cover panel. For details about removing the cover panel, see "3.3 HDD Installation".
- Step 2** Find the reset button on the mainboard, and then connect the Device to the power



source again.

**Step 3** Press and hold the reset button for 5 seconds to 10 seconds.

Figure 5-284 Reset button



**Step 4** Restart the Device.

After the Device restarts, the settings have been restored to the factory default.

## 5.19.4.4 System Update

### 5.19.4.4.1 Upgrading File

#### Procedure

**Step 1** Insert a USB storage device containing the upgrade files into the USB port of the Device.

**Step 2** Select Main Menu > MAnalytics+NTAnalytics+N > Manager > Update

Figure 5-285 Update

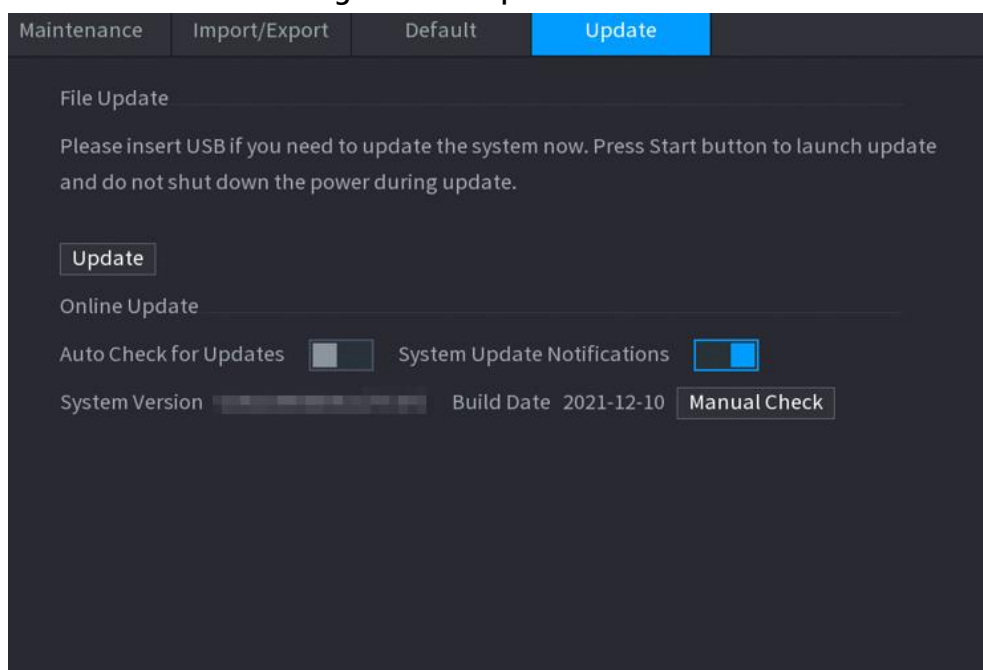

**Step 3** Click Update.

Figure 5-286 Browse

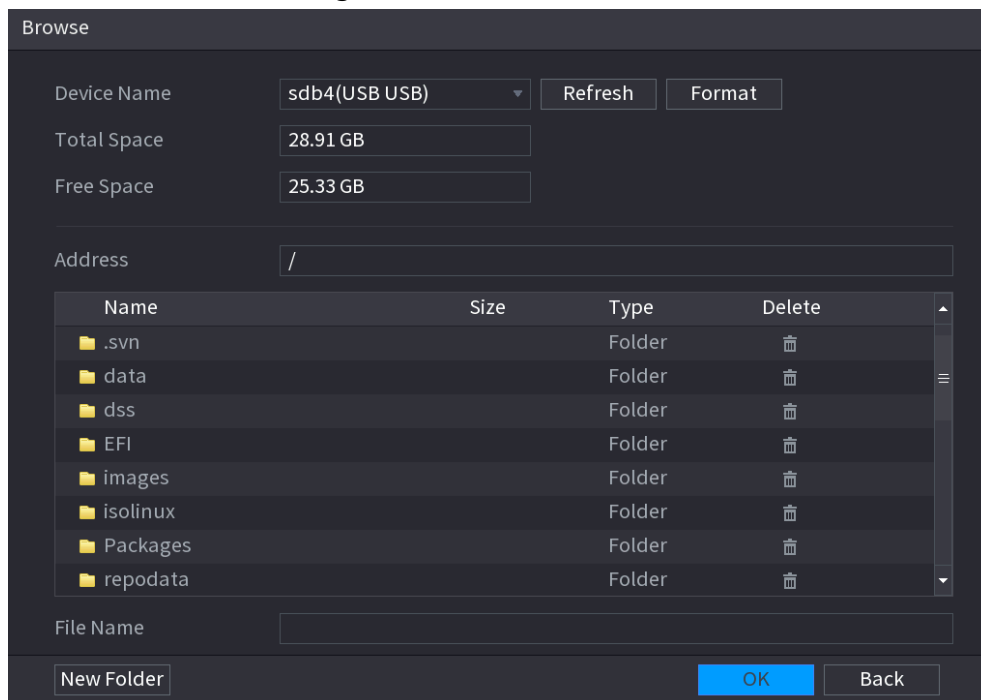

**Step 4** Click the file that you want to upgrade.

**Step 5** The selected file is displayed in the Update File box.

**Step 6** Click Start.

#### 5.19.4.4.2 Online Upgrade

### Background Information

When the Device is connected to Internet, you can use online upgrade function to upgrade the system.

Before using this function, you need to check whether there is any new version by auto check or manual check.

- Auto check: The Device checks if there is any new version available at intervals.
- Manual check: Perform real-time check whether there is any new version available.



Ensure the correct power supply and network connection during upgrading; otherwise the upgrading might be failed.

### Procedure

**Step 1** Select Main Menu > MAnalytics+NTAnalytics+N > Manager > Update.

**Step 2** Check whether there is any new version available.

- Auto-check for updates: Enable Auto-check for updates.
- Manual check: Click Manual Check.

The system starts checking the new versions. After checking is completed, the check

result is displayed.

- If the "It is the latest version" text is displayed, you do not need to upgrade.
- If the text indicating there is a new version, go to the step 3.

**Step 3** Click Update now to update the system.

#### 5.19.4.4.3 Uboot Upgrading



- Under the root directory in the USB storage device, there must be "u-boot.bin.img" file and "update.img" file saved, and the USB storage device must be in FAT32 format.
- Make sure the USB storage device is inserted; otherwise the upgrading cannot be performed.

When starting the Device, the system automatically checks whether there is a USB storage device connected and any upgrade file, and if yes and the check result of the upgrade file is correct, the system will upgrade automatically. The Uboot upgrade can avoid the situation that you have to upgrade through +TFTP when the Device is halted.

#### 5.19.4.5 Intelligent Diagnosis

##### Background Information

When exception occurs, export data to check details.

Select Maintain > Intelligent Diagnosis.

Figure 5-287 Intelligent diagnosis

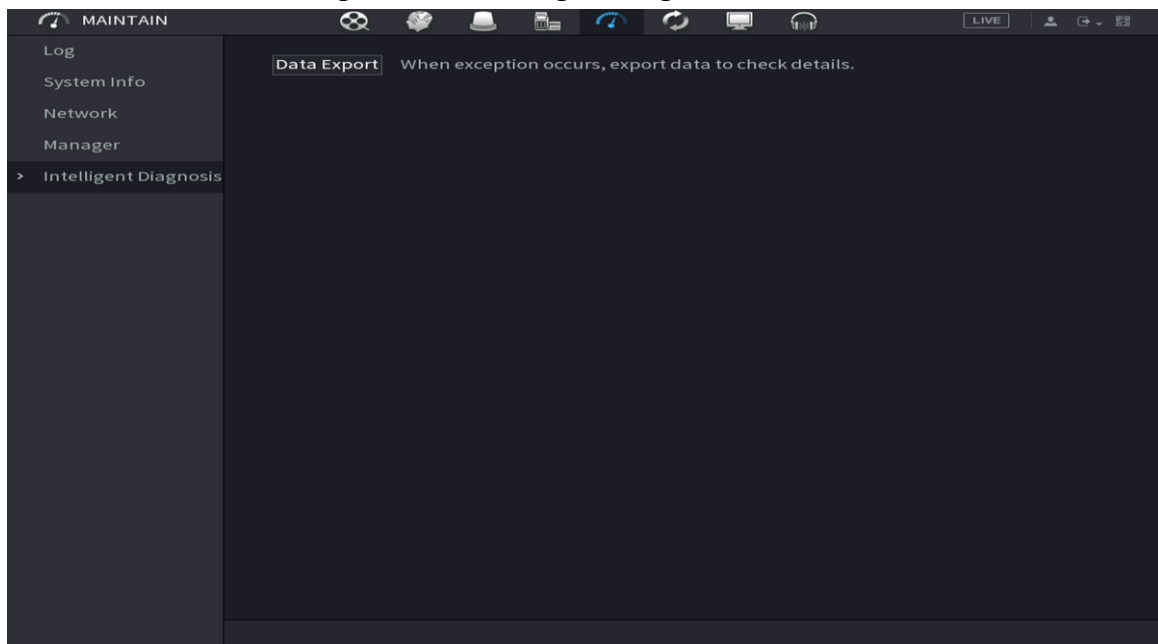

## 5.20 USB Device Auto Pop-up

After you inserted the USB device, system can auto detect it and pop up the following dialogue box. It allows you to conveniently backup file, log, configuration or update system.



You can add a USB keyboard through USB port, and it can input characters limited to soft keyboard.

Figure 5-288 USB device prompt

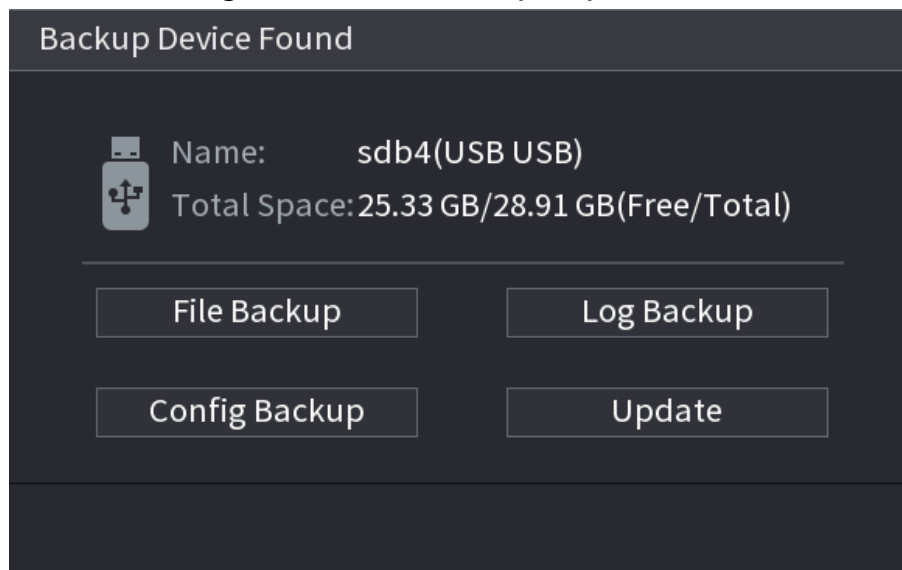

## 5.21 Shutdown



- When you see corresponding dialogue box "System is shutting down..." Do not click power on-off button directly.
- Do not unplug the power cable or click power on-off button to shutdown device directly when device is running (especially when it is recording.)
- Shut down the device and then unplug the power cable before you replace the HDD.

### Procedure

- From the main menu (Recommended)
  1. Click  at the upper-right corner.

Figure 5-289 Shutdown (1)



**2. Select Shutdown.**

Draw the unlock pattern or input password first if you have no authority to shut down.

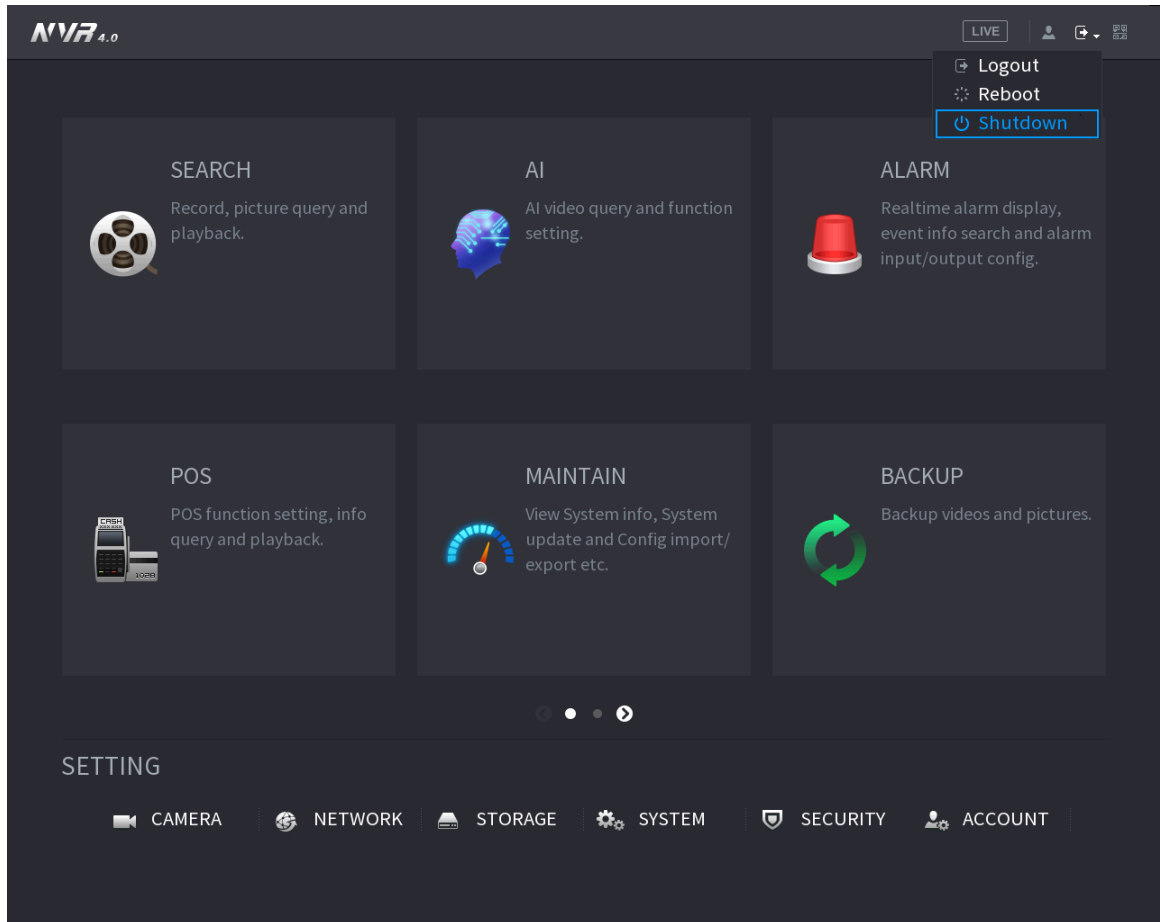
Figure 5-290 Shutdown (2)

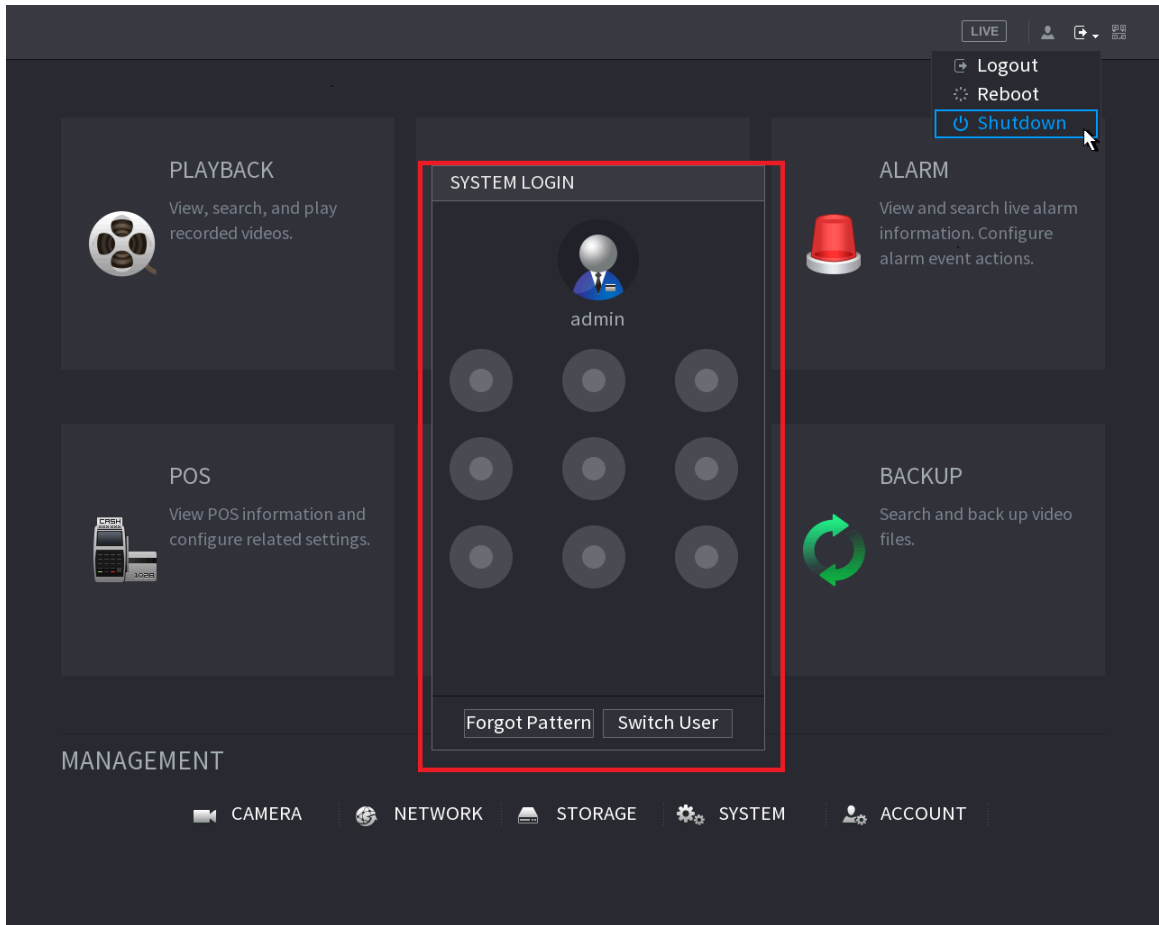
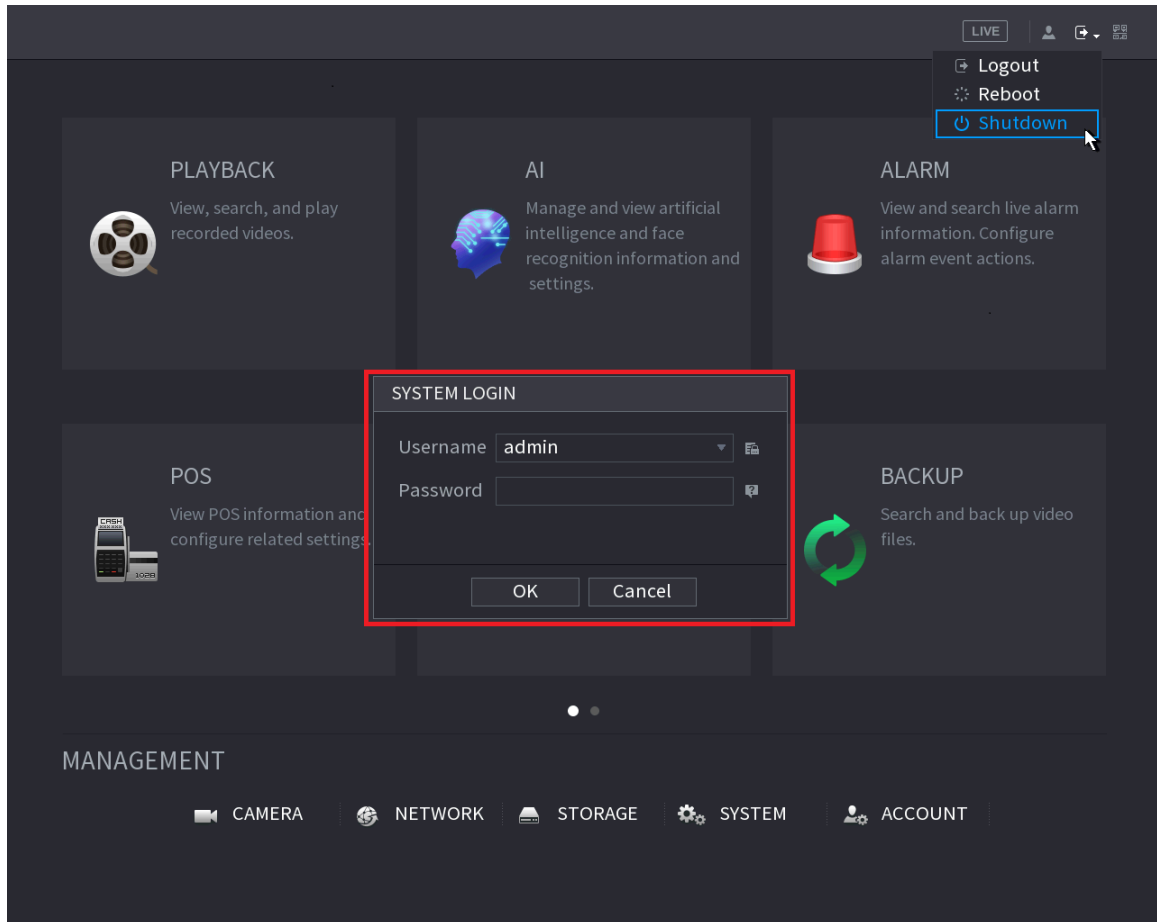

Figure 5-291 Shutdown (3)



- Remote Control  
Press the power button on the remote for at least 3 seconds.
- Press the power button at the rear panel of the device.

### Auto Resume after Power Failure

The system can automatically backup video file and resume previous working status after power failure.

## 6 Web Operation



- The figures in the Manual are used for introducing the operations and only for reference. The actual interface might be different dependent on the model you purchased.
- The Manual is a general document for introducing the product, so there might be some functions described for the Device in the Manual not apply to the model you purchased.
- Besides Web, you can use our Smart PSS to login the device. For detailed information, see Smart PSS user's manual.

### 6.1 Network Connection

#### Background Information



- The factory default IP of the Device is 192.168.1.108.
- The Device supports monitoring on different browsers such as Safari, Firefox, Google to perform the functions such as multi-channel monitoring, PTZ control, and device parameters configurations.

#### Procedure

- Step 1 Check to make sure the Device has connected to the network.
- Step 2 Configure the IP address, subnet mask and gateway for the PC and the Device. For details about network configuration of the Device, see "5.19.3 Network".
- Step 3 On your PC, check the network connection of the Device by using "ping \*\*\*.\*\*\*.\*\*\*.\*\*\*". Usually the return value of TTL is 255.

### 6.2 Web Login

#### Procedure

- Step 1 Open the browser, enter the IP address of the Device, and then press Enter.



Figure 6-1 Login

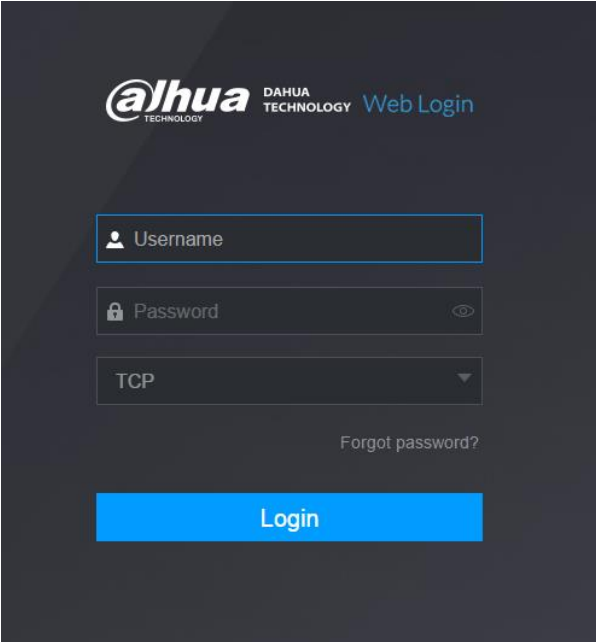

**Step 2** Enter the username and password.



- The default administrator account is admin. The password is the one that was configured during initial settings. To ensure your account security, we recommend you keep the password properly and change it regularly.
- Click  to display the password.

**Step 3** Click Login.

## 6.3 Web Main Menu

After you have logged in to the web, the main menu is displayed.  
For detailed operations, see "5 Local Operations".

Figure 6-2 Main menu

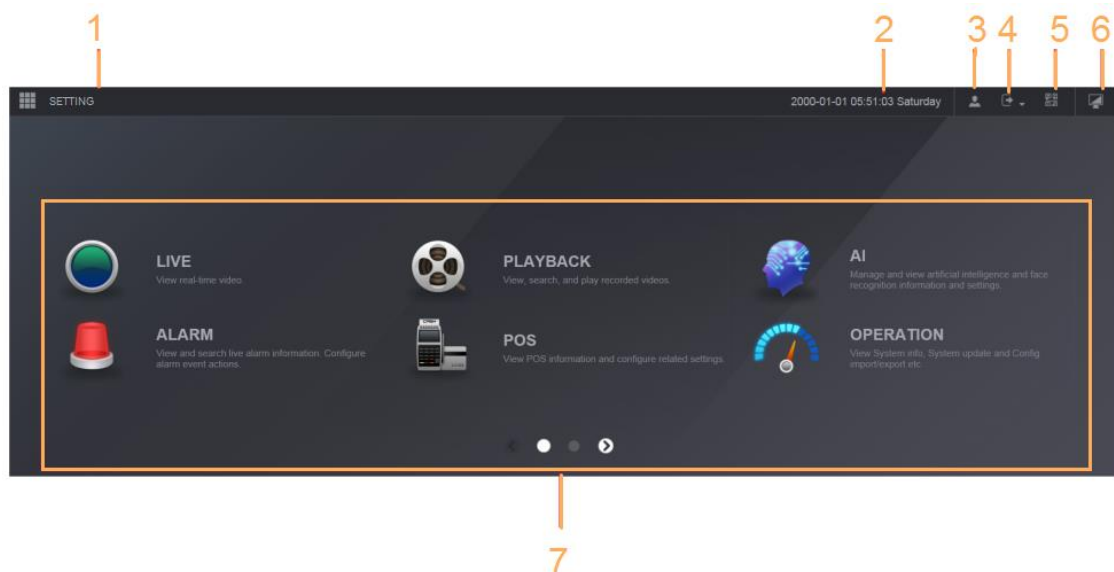

Table 6-1 Main menu symbols

No.	Icon	Description
1		Includes configuration menu through which you can configure camera settings, network settings, storage settings, system settings, account settings, and view information.
2	None	Displays system date and time.
3		When you point to , the current user account is displayed.
4		Click , select Logout, Reboot, or Shutdown according to your actual situation.
5		Displays Cell Phone Client and Device SN QR Code. <ul style="list-style-type: none"> <li>Cell Phone Client: Use your mobile phone to scan the QR code to add the device into the Cell Phone Client, and then you can start accessing the Device from your cell phone.</li> <li>Device SN: Obtain the Device SN by scanning the QR code. Go to the P2P management platform and add the Device SN into the platform. Then you can access and manage the device in the WAN. For details, see the P2P operation manual. You can also configure P2P function in the local configurations, see "5.11.18 P2P".</li> </ul>
6		Displays the web main menu.

No.	Icon	Description
7	None	<p>Includes eight function tiles: LIVE, PLAYBACK, Analytics+, ALARM, POS, OPERATION, BACKUP, DISPLAY, and AUDIO. Click each tile to open the configuration interface of the tile.</p> <ul style="list-style-type: none"> <li>• <b>LIVE:</b> You can perform the operations such as viewing real-time video, configuring channel layout, setting PTZ controls, and using smart talk and instant record functions if needed.</li> <li>• <b>PLAYBACK:</b> Search for and play back the recorded video saved on the Device.</li> <li>• <b>ALARM:</b> Search for alarm information and configure alarm event actions.</li> <li>• <b>Analytics+:</b> Configure and manage artificial intelligent events. It includes smart search, parameters, and database.</li> <li>• <b>POS:</b> View POS information and configure related settings.</li> <li>• <b>OPERATION:</b> View system information, import/export system configuration files, or update system.</li> <li>• <b>BACKUP:</b> Search and back up the video files to the local PC or external storage device such as USB storage device.</li> <li>• <b>DISPLAY:</b> Configure the display effect such as displaying content, image transparency, and resolution, and enable the zero-channel function.</li> <li>• <b>AUDIO:</b> Manage audio files and configure the playing schedule. The audio file can be played in response to an alarm event if the voice prompts function is enabled.</li> </ul>

## 6.4 Cluster Service

The cluster function, also known as cluster redundancy, is a kind of deployment method that can improve the reliability of the device. In the cluster system, there is a number of main devices and another number of sub devices (the N+M mode), and they have a virtual IP address (the cluster IP). When the main device fails, the corresponding sub device will take over the job automatically. When the main device recovers, the sub device will transmit the configuration data, cluster IP address and videos recorded during the failure to the main device which then takes over the job again.

In the N+M cluster system, there is a management server, the DCS (Dispatching Console) server, which is responsible for timely and correct scheduling management of the main and sub devices. When you create a cluster, the current device is used as the first sub device and

the DCS server by default.



This function is available on select models.

## 6.4.1 Configuring Cluster IP

### Background Information

When the main device malfunctions, the sub device can use the main device configuration and virtual IP address to replace the work (monitor or record) accordingly. When you use the virtual IP to access the device, you can still view the real-time video and there is no risk of record loss.

### Procedure

- Step 1 Log in to the web as the admin user.
- Step 2 Select SETTING > Cluster Service > CLUSTER IP.
- Step 3 Select Enable.
- Step 4 Configure IP Address, Subnet Mask and Default Gateway.
- Step 5 Click OK.

## 6.4.2 Main Device

### Background Information

You can add several main devices manually. After you enable the cluster function, you can view IP address, working status and connection log of the main device.

### Procedure

- Step 1 Select SETTING > Cluster Service > Main Device.
- Step 2 Click Manual Add.

Figure 6-3 Manual add

**Step 3** Configure parameters.

Table 6-2 Parameters of adding main device

Parameter	Description
Device Name	Customize the device name.
IP Address	Enter the IP address of the NVR.
Port	Set the TCP port number of the server. The default value is 37777. You can view the current TCP port number in SETTING > Network > Port.
Username/Password	Enter the username and password of the NVR.

**Step 4** Click OK.

**Step 5** (Optional) Click to view event occurrence time, name, operation and reason.

## 6.4.3 Sub Device

### Background Information

When you add the first sub device, the default IP is the device IP address that logs in on the web.

From SETTING > Cluster Service > Sub Device, you can add sub devices. For details, see "6.4.2 Main Device".



When adding the first sub device, you need not enter the IP address, because the first sub device is the current device by default.

After you added main device and sub device, you need to enable cluster function. See "6.4.5 Configuring Cluster Control" for more information.

## 6.4.4 Transferring Videos

After the main device has recovered, the videos recorded on the sub device during the failure period can be transferred to the main device.

### Prerequisites

The main device works normally.

### Procedure

**Step 1** Select SETTING > Cluster Service > Transfer Recorder.

**Step 2** Click Add Task.

**Step 3** Configure parameters.

**Step 4** Click OK.

You can click  to view details on the transferring task.

## 6.4.5 Configuring Cluster Control

### 6.4.5.1 Cluster Control

#### Background Information

From SETTING > Cluster Service > Cluster Control, you can enable or disable cluster.

Figure 6-4 Start cluster

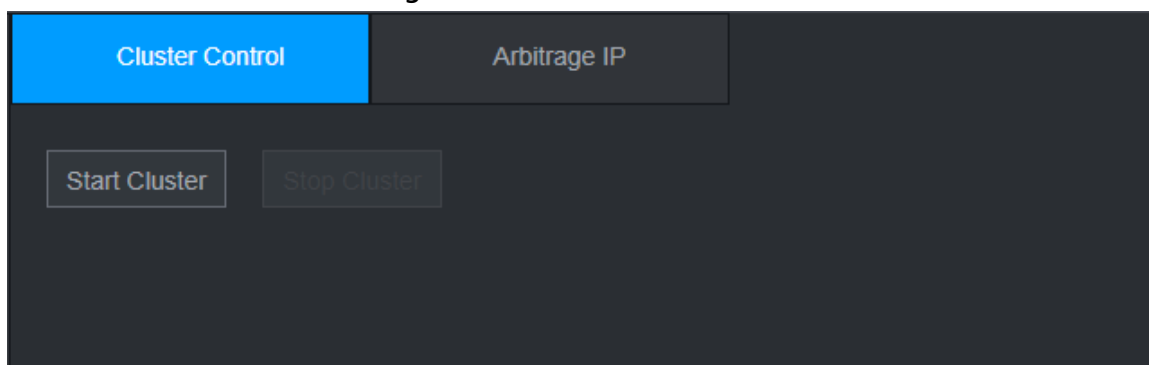

You can see the corresponding prompt if you successfully enabled cluster service.

## 6.4.5.2 Arbitrage IP

### Background Information

When there are only 2 devices in the cluster, a third-party device is required to determine whether the main device is faulty, so arbitration IP must be set for the cluster to perform a normal replacement operation. The arbitration IP can be the IP address of another device, computer or gateway.

### Procedure

**Step 1** Select SETTING > Cluster Service > Arbitrage IP.

Figure 6-5 Arbitrage IP

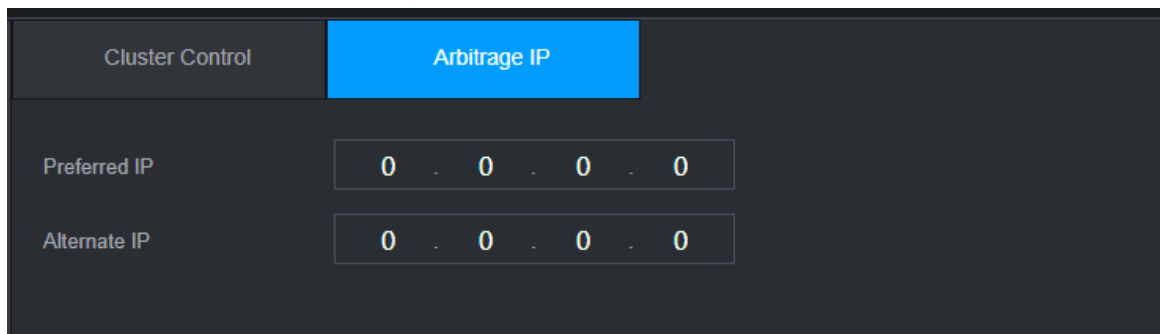

Cluster Control	Arbitrage IP
Preferred IP	0 . 0 . 0 . 0
Alternate IP	0 . 0 . 0 . 0

**Step 2** Configure the preferred and alternate IP.

**Step 3** Click OK.

## 6.4.6 Cluster Log

### Background Information

You can search for and view cluster logs.

### Procedure

**Step 1** Select SETTING > Cluster Service > Cluster Log.

Figure 6-6 Cluster log

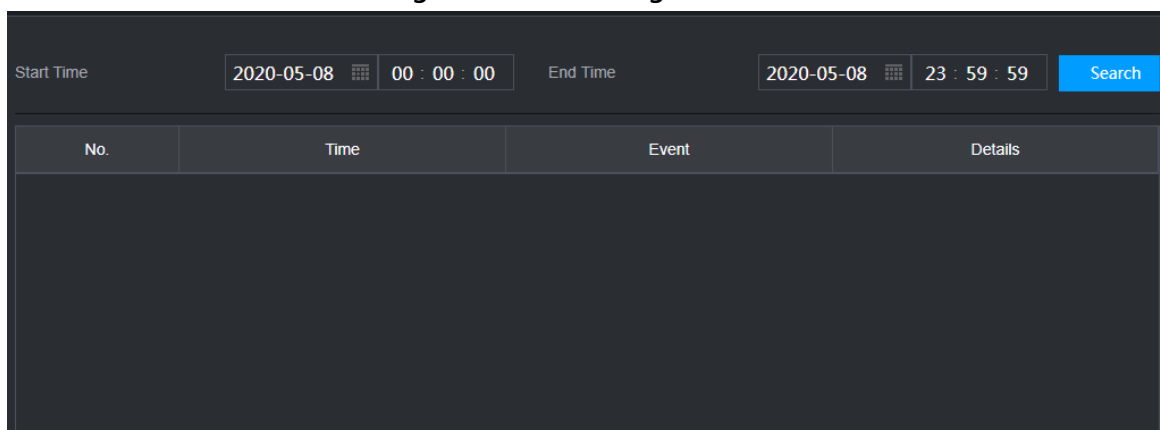

No.	Time	Event	Details

**Step 2** Enter the start time and end time.

**Step 3** Click Search.

## 7 Glossary

- **DHCP:** DHCP (Dynamic Host Configuration Protocol) is one of the TCP/IP protocol cluster. It is mainly used to assign temporary IP addresses to computers on a network.
- **DDNS:** DDNS (Dynamic Domain Name Server) is a service that maps Internet domain names to IP addresses. This service is useful to anyone who wants to operate a server (web server, mail server, ftp server and more.) connected to the internet with a dynamic IP or to someone who wants to connect to an office computer or server from a remote location with software.
- **eSATA:** eSATA (External Serial AT) is an interface that provides fast data transfer for external storage devices. It is the extension specifications of a SATA interface.
- **GPS:** GPS (Global Positioning System) is a satellite system, protected by the US, safely orbiting thousands of kilometers above the earth.
- **PPPoE:** PPPoE (Point to Point Protocol over Ethernet) is a specification for connecting multiple computer users on an Ethernet local area network to a remote site. Now the popular mode is ADSL and it adopts PPPoE protocol.
- **Wi-Fi:** Wi-Fi is the name of a popular wireless networking technology that uses radio waves to provide wireless high-speed Internet and network connections. The standard is for wireless local area networks (WLANs). It is like a common language that all the devices use to communicate to each other. It is actually IEEE802.11, a family of standard The IEEE (Institute of Electrical and Electronics Engineers Inc.)
- **3G:** 3G is the wireless network standard. It is called 3G because it is the third generation of cellular telecom standards. 3G is a faster network for phone and data transmission and speed is over several hundred kbps. Now there are four standards: CDMA2000, WCDMA, TD-SCDMA and WiMAX.
- **Dual-stream:** The dual-stream technology adopts high-rate bit stream for local HD storage such as QCIF/CIF/2CIF/DCIF/4CIF encode and one low-rate bit stream for network transmission such as QCIF/CIF encode. It can balance the local storage and remote network transmission. The dual-stream can meet the difference band width requirements of the local transmission and the remote transmission. In this way, the local transmission using high-bit stream can achieve HD storage and the network transmission adopting low bit stream suitable for the fluency requirements of the 3G network such as WCDMA, EVDO, TD-SCDMA.
- **On-off value:** It is the non-consecutive signal sampling and output. It includes remote sampling and remote output. It has two statuses: 1/0.



## 8 FAQ

Questions	Reasons
The Device failed to start properly.	<ul style="list-style-type: none"> <li>• Incorrect input power.</li> <li>• Incorrect connection of the power cord.</li> <li>• Damaged power switch.</li> <li>• Wrong program.</li> <li>• Damaged HDD.</li> <li>• Damaged mainboard.</li> </ul>
The Device automatically shuts down or stops running.	<ul style="list-style-type: none"> <li>• Unstable or insufficient input voltage.</li> <li>• Insufficient button power.</li> <li>• Improper operating environment.</li> <li>• Hardware error.</li> </ul>
The Device cannot detect HDD.	<ul style="list-style-type: none"> <li>• Damaged HDD or HDD ribbon.</li> <li>• Loose connection of HDD cable.</li> <li>• Damaged SATA port.</li> </ul>
There is no video output in all channels.	<ul style="list-style-type: none"> <li>• Program version is not correct.</li> <li>• Brightness is 0.</li> <li>• Hardware error.</li> </ul>
I cannot find local records.	<ul style="list-style-type: none"> <li>• Damaged HDD or HDD ribbon.</li> <li>• Program version is not correct.</li> <li>• The recorded file has been overwritten.</li> <li>• The recording function has been disabled.</li> </ul>
Distorted recorded videos.	<ul style="list-style-type: none"> <li>• Video quality setup is too low.</li> <li>• Program read error, bit data is too small. There is mosaic in the full screen. Restart the NVR to solve this problem.</li> <li>• HDD data ribbon error.</li> <li>• HDD malfunction.</li> <li>• NVR hardware malfunctions.</li> </ul>
Time display is not correct.	<ul style="list-style-type: none"> <li>• Setup is not correct.</li> <li>• Battery contact is not correct or voltage is too low.</li> <li>• Crystal is broken.</li> </ul>

Questions	Reasons
NVR cannot control PTZ.	<ul style="list-style-type: none"> <li>• Front panel PTZ error.</li> <li>• PTZ decoder setup, connection or installation is not correct.</li> <li>• Cable connection is not correct.</li> <li>• PTZ setup is not correct.</li> <li>• PTZ decoder and NVR protocol is not compatible.</li> <li>• PTZ decoder and NVR address is not compatible.</li> <li>• When there are several decoders, add 120 Ohm between the PTZ decoder A/B cables furthest end to delete the reverberation or impedance matching. Otherwise the PTZ control is not stable.</li> <li>• The distance is too far.</li> </ul>
I cannot log in client-end or web.	<ul style="list-style-type: none"> <li>• For Windows 98 or Windows ME user, update your system to Windows 2000 sp4. Or you can install client-end software of lower version. Please note right now, our NVR is not compatible with Windows VISTA control.</li> <li>• ActiveX control has been disabled.</li> <li>• No dx8.1 or higher. Upgrade display card driver.</li> <li>• Network connection error.</li> <li>• Network setup error.</li> <li>• Password or username is invalid.</li> <li>• Client-end is not compatible with NVR program.</li> </ul>
There is only mosaic no video when preview or playback video file remotely.	<ul style="list-style-type: none"> <li>• Network fluency is not good.</li> <li>• Client-end resources are limit.</li> <li>• Current user has no right to monitor.</li> </ul>
Network connection is not stable.	<ul style="list-style-type: none"> <li>• Network is not stable.</li> <li>• IP address conflict.</li> <li>• MAC address conflict.</li> <li>• PC or device network card is not good.</li> </ul>
Burn error /USB back error.	<ul style="list-style-type: none"> <li>• Burner and NVR are in the same data cable.</li> <li>• System uses too much CPU resources. Stop record first and then begin backup.</li> <li>• Data amount exceeds backup device capacity. It might result in burner error.</li> <li>• Backup device is not compatible.</li> <li>• Backup device is damaged.</li> </ul>

Questions	Reasons
Keyboard cannot control NVR.	<ul style="list-style-type: none"> <li>• NVR serial port setup is not correct.</li> <li>• Address is not correct.</li> <li>• When there are several switchers, power supply is not enough.</li> <li>• Transmission distance is too far.</li> </ul>
Alarm signal cannot be disarmed.	<ul style="list-style-type: none"> <li>• Alarm setup is not correct.</li> <li>• Alarm output has been open manually.</li> <li>• Input device error or connection is not correct.</li> <li>• Some program versions might have this problem. Upgrade your system.</li> </ul>
Alarm function is null.	<ul style="list-style-type: none"> <li>• Alarm setup is not correct.</li> <li>• Alarm cable connection is not correct.</li> <li>• Alarm input signal is not correct.</li> <li>• There are two loops connect to one alarm device.</li> </ul>
Record storage period is not enough.	<ul style="list-style-type: none"> <li>• Camera quality is too low. Lens is dirty. Camera is installed against the light. Camera aperture setup is not correct.</li> <li>• HDD capacity is not enough.</li> <li>• HDD is damaged.</li> </ul>
Cannot playback the downloaded file.	<ul style="list-style-type: none"> <li>• There is no media player.</li> <li>• No DXB8.1 or higher graphic acceleration software.</li> <li>• There is no DivX503Bundle.exe control when you play the file transformed to AVI via media player.</li> <li>• No DivX503Bundle.exe or ffdshow-2004 1012 .exe in Windows XP OS.</li> </ul>
Forgot local menu operation password or network password	Contact your local service engineer or our sales person for help. We can guide you to solve this problem.
There is no video. The screen is in black.	<ul style="list-style-type: none"> <li>• IPC IP address is not right.</li> <li>• IPC port number is not right.</li> <li>• IPC account (username/password) is not right.</li> <li>• IPC is offline.</li> </ul>
The displayed video is not full in the monitor.	Check current resolution setup. If the current setup is 1920*1080, then you need to set the monitor resolution as 1920*1080.
There is no HDMI output.	<ul style="list-style-type: none"> <li>• Displayer is not in HDMI mode.</li> <li>• HDMI cable connection is not right.</li> </ul>

Questions	Reasons
The video is not fluent when I view in multiple-channel mode from the client-end.	<ul style="list-style-type: none"> <li>The network bandwidth is not sufficient. The multiple-channel monitor operation needs at least 100M or higher.</li> <li>Your PC resources are not sufficient. For 16-ch remote monitor operation, the PC shall have the following environment: Quad Core, 2G or higher memory, independent displayer, display card memory 256M or higher.</li> </ul>
I cannot connect to the IPC	<ul style="list-style-type: none"> <li>Make sure that the IPC has booted up.</li> <li>IPC network connection is right and it is online</li> <li>IPC IP is in the blacklist.</li> <li>The device has connected to the too many IPC. It cannot transmit the video.</li> <li>Check the IPC port value and the time zone is the same as the NVR.</li> <li>Make sure current network environment is stable.</li> </ul>
After I set the NVR resolution as 1080P, my monitor cannot display.	Shut down the device and then reboot. When you reboot, press the Fn button at the same time and then release after 5 seconds. You can restore NVR resolution to the default setup.
My admin account has been changed and I cannot log in.	Use telnet and then input the following command: <pre>cd /mnt/mtd/Config/ rm -rf group rm -rf password</pre> Reboot the device to restore the default password.
After I login the Web, I cannot find the remote interface to add the IPC.	Clear the Web controls and load again.
There is IP and gateway, I can access the internet via the router. But I cannot access the internet after I reboot the NVR.	Use command PING to check you can connect to the gateway or not. Use telnet to access and then use command "ifconfig-a" to check device IP address. If you see the subnet mask and the gateway has changed after the reboot. Upgrade the applications and set again.
I use the VGA monitor. I want to know if I use the multiple-window mode, I see the video from the main stream or the sub stream?	<ul style="list-style-type: none"> <li>For 32-channel series product, the 9/16-window is using the sub stream.</li> <li>For 4/8/16 series product, system is using the main stream no matter you are in what display mode.</li> </ul>

## Daily Maintenance

- Use the brush to clean the board, socket connector and the chassis regularly.
- The device shall be soundly earthed in case there is audio/video disturbance. Keep the

device away from the static voltage or induced voltage.

- Unplug the power cable before you remove the audio/video signal cable, RS-232 or RS-485 cable.
- Do not connect the TV to the local video output port (VOUT). It might result in video output circuit.
- Always shut down the device properly. Use the shutdown function in the menu, or you can press the power button in the rear pane for at least three seconds to shut down the device. Otherwise it might result in HDD malfunction.
- Make sure the device is away from the direct sunlight or other heating sources. Keep the sound ventilation.
- Check and maintain the device regularly.

## Appendix 1 HDD Capacity Calculation

Calculate the total capacity needed by each device according to video recording (video recording type and video file storage time).

1. According to Formula (1) to calculate storage capacity  $q_i$  that is the capacity of each channel needed for each hour, unit Mbyte.

$$q_i = d_i \div 8 \times 3600 \div 1024 \quad (1)$$

In the formula:  $d_i$  means the bit rate, unit Kbit/s

2. After video time requirement is confirmed, according to Formula (2) to calculate the storage capacity  $m_i$ , which is storage of each channel needed unit Mbyte.

$$m_i = q_i \times h_i \times D_i \quad (2)$$

In the formula:

$h_i$  means the recording time for each day (hour)

$D_i$  means number of days for which the video shall be kept

3. According to Formula (3) to calculate total capacity (accumulation)  $q_T$  that is needed for all channels in the device during scheduled video recording

$$q_T = \sum_{i=1}^c m_i \quad (3)$$

In the formula:

$c$  means total number of channels in one device

4. According to Formula (4) to calculate total capacity (accumulation)  $q_T$  that is needed for all channels in device during alarm video recording (including motion detection)

$$q_T = \sum_{i=1}^c m_i \times a\% \quad (4)$$

In the formula:  $a\%$  means alarm occurrence rate

## Appendix 2 Mouse Operation

Appendix Table 2-1 Mouse operation

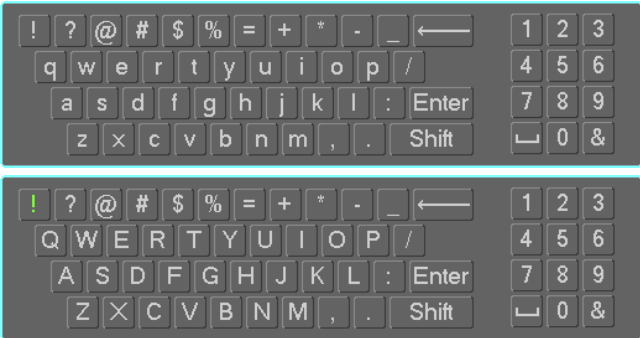
Operation	Description
Left click mouse	When you have selected one menu item, left click mouse to view menu content.
	Modify checkbox or motion detection status.
	Click combo box to pop up drop-down list
	<p>In input box, you can select input methods. Left click the corresponding button on the panel you can input numeral/English character (lower case/upper case). Here← stands for backspace button. _ stands for space button.</p> <p>In English input mode: _ stands for input a backspace icon and← stands for deleting the previous character.</p>  <p>In numeral input mode: _ stands for clear and← stands for deleting the previous numeral.</p>
Double left click mouse	Implement special control operation such as double click one item in the file list to playback the video.
	<p>In multiple-window mode, double left click one channel to view in full-window.</p> <p>Double left click current video again to go back to previous multiple-window mode.</p>
Right click mouse	In real-time monitor mode, pops up shortcut menu.
	Exit current menu without saving the modification.
Press middle button	In numeral input box: Increase or decrease numeral value.
	Switch the items in the checkbox.
	Page up or page down.
Move mouse	Select current control or move control.
Drag mouse	Select motion detection zone.
	Select privacy mask zone.

## Appendix 3 Remote Control



Remote control is not our standard accessory and it is not included in the accessory package.

Appendix Figure 3-1 Remote control

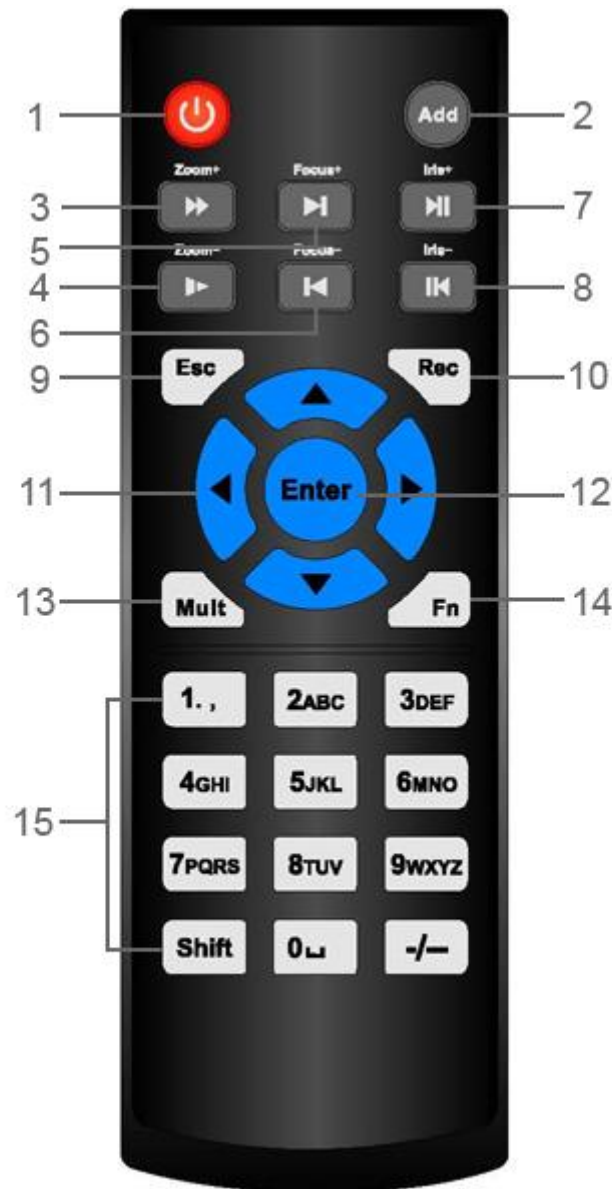

No.	Name	Function
1	Power button	Press this button to boot up or shut down the device.
2	Address	Press this button to input device serial number, so that you can control the Device.
3	Forward	Multi-step forward speed and normal speed playback.



No.	Name	Function
4	Slow motion	Multi-step slow motion speed or normal playback.
5	Next record	In playback state, press this button to play back the next video.
6	Previous record	In playback state, press this button to play back the previous video.
7	Play/Pause	<ul style="list-style-type: none"> <li>• In normal playback state, press this button to pause playback.</li> <li>• In pause state, press this button to resume to normal playback.</li> <li>• In live view window interface, press this button to enter video search menu.</li> </ul>
8	Reverse/pause	In the reverse playback state, press this button to pause reverse playback.
		In the reverse playback pause state, press this button to resume to playback reversing state.
9	Esc	Go back to previous menu or cancel current operation (close front interface or control).
10	Record	<ul style="list-style-type: none"> <li>• Start or stop record manually.</li> <li>• In record interface, use the direction buttons to select the channel that you want to record.</li> <li>• Press this button for at least 1.5 seconds, and the manual record interface will be displayed.</li> </ul>
11	Direction keys	Switch between current activated controls by going left or right. In playback state, the keys control the playback progress bar. Aux function (such as operating the PTZ menu).
12	Enter/menu key	<ul style="list-style-type: none"> <li>• Confirms an operation.</li> <li>• Go to the OK button.</li> <li>• Go to the menu.</li> </ul>
13	Multiple-window switch	Switch between multiple-window and one-window.

No.	Name	Function
14	Fn	<ul style="list-style-type: none"> <li>• In single-channel monitoring mode, press this button to display the PTZ control and color setting functions.</li> <li>• Switch the PTZ control menu in PTZ control interface.</li> <li>• In motion detection interface, press this button with direction keys to complete setup.</li> <li>• In text mode, press and hold this button to delete the last character. To use the clearing function: Long press this button for 1.5 seconds.</li> <li>• In HDD menu, switch HDD recording time and other information as indicated in the pop-up message.</li> </ul>
15	Alphanumeric keys	<ul style="list-style-type: none"> <li>• Input password, numbers.</li> <li>• Switch channel.</li> <li>• Press Shift to switch the input method.</li> </ul>

## Appendix 4 Compatible Network Camera List

Please note all the models in the following list for reference only. For those products not included in the list, please contact your local retailer or technical supporting engineer for detailed information.

Appendix Table 4-1 Compatible network camera list

Manufacturer	Model	Version	Video Encode	Audio/Video	Protocol
AXIS	P1346	5.40.9.2	H264	√	ONVIF/Private
	P3344/P3344-E	5.40.9.2	H264	√	ONVIF/Private
	P5512	—	H264	√	ONVIF/Private
	Q1604	5.40.3.2	H264	√	ONVIF/Private
	Q1604-E	5.40.9	H264	√	ONVIF/Private
	Q6034E	—	H264	√	ONVIF/Private
	Q6035	5.40.9	H264	√	ONVIF/Private
	Q1755	—	H264	√	ONVIF/Private
	M7001	—	H264	√	Private
	M3204	5.40.9.2	H264	√	Private
	P3367	HEAD LFP4_0 130220	H264	√	ONVIF
P5532-P	HEAD LFP4_0 130220	H264	√	ONVIF	
ACTi	ACM-3511	A1D-220-V3. 12.15-AC	MPEG4	√	Private
	ACM-8221	A1D-220-V3. 13.16-AC	MPEG4	√	Private
Arecont	AV1115	65246	H264	√	Private
	AV10005DN	65197	H264	√	Private
	AV2115DN	65246	H264	√	Private
	AV2515DN	65199	H264	√	Private
	AV2815	65197	H264	√	Private
	AV5115DN	65246	H264	√	Private
	AV8185DN	65197	H264	√	Private

Manufacturer	Model	Version	Video Encode	Audio/Video	Protocol
Bosch	NBN-921-P	—	H264	√	ONVIF
	NBC-455-12P	—	H264	√	ONVIF
	VG5-825	9500453	H264	√	ONVIF
	NBN-832	66500500	H264	√	ONVIF
	VEZ-211-IWTEIVA	—	H264	√	ONVIF
	NBC-255-P	15500152	H264	√	ONVIF
	VIP-X1XF	—	H264	√	ONVIF
Brikcom	B0100	—	H264	√	ONVIF
	D100	—	H264	√	ONVIF
	GE-100-CB	—	H264	√	ONVIF
	FB-100A	v1.0.3.9	H264	√	ONVIF
	FD-100A	v1.0.3.3	H264	√	ONVIF
Cannon	VB-M400	—	H264	√	Private
CNB	MPix2.0DIR	XNETM1120111229	H264	√	ONVIF
	VIPBL1.3MIRVF	XNETM2100111229	H264	√	ONVIF
	IGC-2050F	XNETM2100111229	H264	√	ONVIF
CP PLUS	CP-NC9-K	6.E.2.7776	H264	√	ONVIF/Private
	CP-NC9W-K	6.E.2.7776	H264	√	Private
	CP-ND10-R	cp20111129ANS	H264	√	ONVIF
	CP-ND20-R	cp20111129ANS	H264	√	ONVIF
	CP-NS12W-CR	cp20110808NS	H264	√	ONVIF
	VS201	cp20111129NS	H264	√	ONVIF
	CP-NB20-R	cp20110808BNS	H264	√	ONVIF

Manufacturer	Model	Version	Video Encode	Audio/Video	Protocol
	CP-NT20V L3-R	cp20110808 BNS	H264	√	ONVIF
	CP-NS36 W-AR	cp20110808 NS	H264	√	ONVIF
	CP-ND20V L2-R	cp20110808 BNS	H264	√	ONVIF
	CP-RNP-1 820	cp20120821 NSA	H264	√	Private
	CP-RNC-T P20FL3C	cp20120821 NSA	H264	√	Private
	CP-RNP-1 2D	cp20120828 ANS	H264	√	Private
	CP-RNC-D V10	cp20120821 NSA	H264	√	Private
	CP-RNC-D P20FL2C	cp20120821 NSA	H264	√	Private
DynaColor	ICS-13	d20120214NS	H264	√	ONVIF/Private
	ICS-20W	vt20111123NSA	H264	√	ONVIF/Private
	NA222	—	H264	√	ONVIF
	MPC-IPVD -0313	k20111208ANS	H264	√	ONVIF/Private
	MPC-IPVD -0313AF	k20111208BNS	H264	√	ONVIF/Private
Honeywell	HIDC-1100 PT	h.2.2.1824	H264	√	ONVIF
	HIDC-1100 P	h.2.2.1824	H264	√	ONVIF
	HIDC-0100 P	h.2.2.1824	H264	√	ONVIF
	HIDC-1300 V	2.0.0.21	H264	√	ONVIF
	HICC-1300 W	2.0.1.7	H264	√	ONVIF
	HICC-2300	2.0.0.21	H264	√	ONVIF
	HDZ20HD X	H20130114NSA	H264	√	ONVIF

Manufacturer	Model	Version	Video Encode	Audio/Video	Protocol
LG	LW342-FP	—	H264	√	Private
	LNB5100	—	H264	√	ONVIF
Imatek	KNC-B5000	—	H264	√	Private
	KNC-B5162	—	H264	√	Private
	KNC-B2161	—	H264	√	Private
Panasonic	NP240/CH	—	MPEG4	√	Private
	WV-NP502	—	MPEG4	√	Private
	WV-SP102H	1.41	H264	√	ONVIF/Private
	WV-SP105H	—	H264	√	ONVIF/Private
	WV-SP302H	1.41	H264, MPEG4	√	ONVIF/Private
	WV-SP306H	1.4	H264, MPEG4	√	ONVIF/Private
	WV-SP508H	—	H264, MPEG4	√	ONVIF/Private
	WV-SP509H	—	H264, MPEG4	√	ONVIF/Private
	WV-SF332H	1.41	H264, MPEG4	√	ONVIF/Private
	WV-SW316H	1.41	H264, MPEG4	√	ONVIF/Private
	WV-SW355H	1.41	H264, MPEG4	√	ONVIF/Private
	WV-SW352H	—	H264, MPEG4	√	ONVIF/Private
	WV-SW152E	1.03	H264, MPEG4	√	ONVIF/Private
	WV-SW558H	—	H264, MPEG4	√	ONVIF/Private
	WV-SW559H	—	H264, MPEG4	√	ONVIF/Private
	WV-SP105H	1.03	H264, MPEG4	√	ONVIF/Private

Manufacturer	Model	Version	Video Encode	Audio/Video	Protocol
	WV-SW155E	1.03	H264, MPEG4	√	ONVIF/Private
	WV-SF336H	1.44	H264, MPEG4	√	ONVIF/Private
	WV-SF332H	1.41	H264, MPEG4	√	ONVIF/Private
	WV-SF132E	1.03	H264, MPEG4	√	ONVIF/Private
	WV-SF135E	1.03	H264, MPEG4	√	ONVIF/Private
	WV-SF346H	1.41	H264, MPEG4	√	ONVIF/Private
	WV-SF342H	1.41	H264, MPEG4	√	ONVIF/Private
	WV-SC385H	1.08	H264, MPEG4	√	ONVIF/Private
	WV-SC386H	1.08	H264, MPEG4	√	ONVIF/Private
	WV-SP539	1.66	H264, MPEG4	√	ONVIF
	DG-SC385	1.66	H264, MPEG4	√	ONVIF
PELCO	IXSOLW	1.8.1-20110912-1.9082-A1.6617	H264	√	Private
	IDE20DN	1.7.41.9111-O3.6725	H264	√	Private
	D5118	1.7.8.9310-A1.5288	H264	√	Private
	IM10C10	1.6.13.9261-O2.4657	H264	√	Private
	DD4N-X	01.02.0015	MPEG4	√	Private
	DD423-X	01.02.0006	MPEG4	√	Private
	D5220	1.8.3-FC2-20120614-1.9320-A1.8035	H264	√	Private
Samsung	SNB-3000P	2.41	H264, MPEG4	√	ONVIF/Private

Manufacturer	Model	Version	Video Encode	Audio/Video	Protocol
	SNP-3120	1.22_110120_1	H264, MPEG4	√	ONVIF/Private
	SNP-3370	1.21_110318	MPEG4	√	Private
	SNB-5000	2.10_111227	H264, MPEG4	√	ONVIF/Private
	SND-5080	—	H264, MPEG4	√	Private
	SNZ-5200	1.02_110512	H264, MPEG4	√	ONVIF/Private
	SNP-5200	1.04_110825	H264, MPEG4	√	ONVIF/Private
	SNB-7000	1.10_110819	H264	√	ONVIF/Private
	SNB-6004	V1.0.0	H264	√	ONVIF
Sony	SNC-D H110	1.50.00	H264	√	ONVIF/Private
	SNC-CH120	1.50.00	H264	√	ONVIF/Private
	SNC-CH135	1.73.01	H264	√	ONVIF/Private
	SNC-CH140	1.50.00	H264	√	ONVIF/Private
	SNC-CH210	1.73.00	H264	√	ONVIF/Private
	SNC-D H210	1.73.00	H264	√	ONVIF/Private
	SNC-D H240	1.50.00	H264	√	ONVIF/Private
	SNC-D H240-T	1.73.01	H264	√	ONVIF/Private
	SNC-CH260	1.74.01	H264	√	ONVIF/Private
	SNC-CH280	1.73.01	H264	√	ONVIF/Private
	SNC-RH-124	1.73.00	H264	√	ONVIF/Private
	SNC-RS46P	1.73.00	H264	√	ONVIF/Private



Manufacturer	Model	Version	Video Encode	Audio/Video	Protocol
	SNC-ER550	1.74.01	H264	√	ONVIF/Private
	SNC-ER580	1.74.01	H264	√	ONVIF/Private
	SNC-ER580	1.78.00	H264	√	ONVIF
	SNC-VM631	1.4.0	H264	√	ONVIF
	WV-SP306	1.61.00	H264, MPEG4	√	SDK
	WV-SP306	1.61.00	H264	√	ONVIF
	SNC-VB600	1.5.0	H264	√	Private
	SNC-VM600	1.5.0	H264	√	Private
	SNC-VB630	1.5.0	H264	√	Private
	SNC-VM630	1.5.0	H264	√	Private
SANYO	VCC-HDN4000PC	—	H264	√	ONVIF

## Appendix 5 Cybersecurity Recommendations

Cybersecurity is more than just a buzzword: it's something that pertains to every device that is connected to the internet. IP video security is not immune to cyber risks, but taking basic steps toward protecting and strengthening networks and networked appliances will make them less susceptible to attacks. Below are some tips and recommendations from Dahua on how to create a more secured security system.

Mandatory actions to be taken for basic device network security:

### 1. Use Strong Passwords

Please refer to the following suggestions to set passwords:

- The length should not be less than 8 characters.
- Include at least two types of characters; character types include upper and lower case letters, numbers and symbols.
- Do not contain the account name or the account name in reverse order.
- Do not use continuous characters, such as 123, abc, etc.
- Do not use overlapped characters, such as 111, aaa, etc.

### 2. Update Firmware and Client Software in Time

- According to the standard procedure in Tech-industry, we recommend to keep your device (such as NVR, DVR, IP camera, etc.) firmware up-to-date to ensure the system is equipped with the latest security patches and fixes. When the device is connected to the public network, it is recommended to enable the "auto-check for updates" function to obtain timely information of firmware updates released by the manufacturer.
- We suggest that you download and use the latest version of client software.

"Nice to have" recommendations to improve your device network security:

### 1. Physical Protection

We suggest that you perform physical protection to device, especially storage devices. For example, place the device in a special computer room and cabinet, and implement well-done access control permission and key management to prevent unauthorized personnel from carrying out physical contacts such as damaging hardware, unauthorized connection of removable device (such as USB flash disk, serial port), etc.

### 2. Change Passwords Regularly

We suggest that you change passwords regularly to reduce the risk of being guessed or cracked.

### 3. Set and Update Passwords Reset Information Timely

The device supports password reset function. Please set up related information for password reset in time, including the end user's mailbox and password protection questions. If the information changes, please modify it in time. When setting password protection questions, it is suggested not to use those that can be easily guessed.

### 4. Enable Account Lock

The account lock feature is enabled by default, and we recommend you to keep it on to guarantee the account security. If an attacker attempts to log in with the wrong password several times, the corresponding account and the source IP address will be locked.

#### 5. Change Default HTTP and Other Service Ports

We suggest you to change default HTTP and other service ports into any set of numbers between 1024–65535, reducing the risk of outsiders being able to guess which ports you are using.

#### 6. Enable HTTPS

We suggest you to enable HTTPS, so that you visit Web service through a secure communication channel.

#### 7. MAC Address Binding

We recommend you to bind the IP and MAC address of the gateway to the device, thus reducing the risk of ARP spoofing.

#### 8. Assign Accounts and Privileges Reasonably

According to business and management requirements, reasonably add users and assign a minimum set of permissions to them.

#### 9. Disable Unnecessary Services and Choose Secure Modes

If not needed, it is recommended to turn off some services such as SNMP, SMTP, UPnP, etc., to reduce risks.

If necessary, it is highly recommended that you use safe modes, including but not limited to the following services:

- SNMP: Choose SNMP v3, and set up strong encryption passwords and authentication passwords.
- SMTP: Choose TLS to access mailbox server.
- FTP: Choose SFTP, and set up strong passwords.
- AP hotspot: Choose WPA2-PSK encryption mode, and set up strong passwords.

#### 10. Audio and Video Encrypted Transmission

If your audio and video data contents are very important or sensitive, we recommend that you use encrypted transmission function, to reduce the risk of audio and video data being stolen during transmission.

Reminder: encrypted transmission will cause some loss in transmission efficiency.

#### 11. Secure Auditing

- Check online users: we suggest that you check online users regularly to see if the device is logged in without authorization.
- Check device log: By viewing the logs, you can know the IP addresses that were used to log in to your devices and their key operations.

#### 12. Network Log

Due to the limited storage capacity of the device, the stored log is limited. If you need to save the log for a long time, it is recommended that you enable the network log function to ensure that the critical logs are synchronized to the network log server for tracing.

#### 13. Construct a Safe Network Environment

In order to better ensure the safety of device and reduce potential cyber risks, we recommend:

- Disable the port mapping function of the router to avoid direct access to the intranet devices from external network.
- The network should be partitioned and isolated according to the actual network needs. If there are no communication requirements between two sub networks, it is suggested to use VLAN, network GAP and other technologies to partition the network, so as to achieve the network isolation effect.
- Establish the 802.1x access authentication system to reduce the risk of unauthorized access to private networks.
- Enable IP/MAC address filtering function to limit the range of hosts allowed to access the device.

## More information

Please visit Dahua official website security emergency response center for security announcements and the latest security recommendations.

