



INSTRUCTION MANUAL

VHF MARINE TRANSCEIVERS

IC-M423
IC-M423G
IC-M423GE
IC-M424
IC-M424G

This device complies with Part 15 of the FCC Rules. Operation is subject to the condition that this device does not cause harmful interference.



IC-M423G

Icom Inc.

PREFACE

Thank you for choosing this Icom product. This product is designed and built with Icom's state of the art technology and craftsmanship. With proper care, this product should provide you with years of trouble-free operation.

◇ FEATURES

- Simple operation with large keys
- Easy to hear speaker
- Built-in DSC meets ITU Class D requirement
- Rugged waterproof construction
- Optional COMMANDMICIV™ (HM-195)
- Easy to make an individual DSC calls using the optional Class B AIS Transponder
- Built-in GPS (For only the IC-M423G and IC-M424G)
- Built-in GPS receiver with a supplied GPS antenna (For only the IC-M423GE)

CLEAN THE TRANSCIVER AND MICROPHONE THOROUGHLY WITH FRESH WATER after exposure to saltwater, and dry it before operating. Otherwise, the transceiver's keys, switches and controllers may become unusable, due to salt crystallization.

NOTE: If the transceiver's waterproof protection appears defective, carefully clean it with a soft, damp (fresh water) cloth, then, dry it before operating. The transceiver may lose its waterproof protection if the case or connector cover is cracked or broken, or the transceiver has been dropped.

IMPORTANT

READ ALL INSTRUCTIONS carefully and completely before using the transceiver.

SAVE THIS INSTRUCTION MANUAL — This instruction manual contains important operating instructions for the transceiver.

EXPLICIT DEFINITIONS

WORD	DEFINITION
⚠ WARNING!	Personal injury, fire hazard or electric shock may occur.
CAUTION	Equipment damage may occur.
NOTE	If disregarded, inconvenience only. No risk of personal injury, fire or electric shock.

Icom is not responsible for the destruction or damage to the Icom transceiver, if the malfunction is because of:

- Force majeure, including, but not limited to, fires, earthquakes, storms, floods, lightnings, or other natural disasters, disturbances, riots, war, or radioactive contamination.
- The use of Icom transceiver with any equipment that is not manufactured or approved by Icom.

IN CASE OF EMERGENCY

If your vessel requires assistance, contact other vessels and the Coast Guard by sending a Distress call on Channel 16.

USING CHANNEL 16

DISTRESS CALL PROCEDURE

1. "MAYDAY MAYDAY MAYDAY"
2. "THIS IS" (name of vessel).
3. Say your call sign or other description of the vessel (AND 9 digit DSC ID if you have one).
4. "LOCATED AT" (your position).
5. State the nature of the distress and assistance required.
6. Give any other information which might facilitate the rescue.

Or, make your Distress call using digital selective calling on Channel 70.

USING DIGITAL SELECTIVE CALLING (Ch 70)

DISTRESS CALL PROCEDURE

1. While lifting up the key cover, hold down [DISTRESS] for 3 seconds until you hear 3 short beeps and then one long beep.
2. Wait for an acknowledgment on Channel 70 from a coast station.
 - After the acknowledgement is received, Channel 16 is automatically selected.
3. Hold down [PTT], then transmit the appropriate information as listed above.

INSTALLATION NOTE

Installation:

The installation of this equipment should be made in such a manner as to respect the EC recommended electromagnetic field exposure limits. (1999/519/EC)

The maximum RF power available from this device is 25 watts. The antenna should be installed as high as possible for maximum efficiency and the installation height should be at least 1.4 meters above any accessible position. In the case where an antenna cannot be installed at a reasonable height, then the transmitter should neither be continuously operated for long periods if any person is within a distance of 1.4 meters of the antenna, nor operated at all if any person is touching the antenna.

It is recommended that antenna of a maximum gain of 3 dB are used. If higher gain antenna are required then please contact your Icom distributor for revised installation recommendations.

Operation:

The exposure to RF electromagnetic field is only applicable when this device is transmitting. This exposure is naturally reduced due to the nature of alternating periods of receiving and transmitting. Keep your transmissions to the minimum necessary.

Icom, Icom Inc. and Icom logo are registered trademarks of Icom Incorporated (Japan) in Japan, the United States, the United Kingdom, Germany, France, Spain, Russia, Australia, New Zealand, and/or other countries.

COMMANDMIC is a registered trademark of Icom Incorporated (Japan) in Japan and the United States.

RADIO OPERATOR WARNING



Icom requires the radio operator to meet the FCC Requirements for Radio Frequency Exposure. An omnidirectional antenna with gain not greater than 9 dBi must be mounted a minimum of 5 meters (measured from the lowest point of the antenna) vertically above the main deck and all possible personnel. This is the minimum safe separation distance estimated to meet all RF exposure compliance requirements. This 5 meter distance is based on the FCC Safe Maximum Permissible Exposure (MPE) distance of 3 meters added to the height of an adult (2 meters) and is appropriate for all vessels.

For watercraft without suitable structures, the antenna must be mounted so as to maintain a minimum of 1 meter vertically between the antenna, (measured from the lowest point of the antenna), to the heads of all persons AND all persons must stay outside of the 3 meter MPE radius.

Do not transmit with radio and antenna when persons are within the MPE radius of the antenna, unless such persons (such as driver or radio operator) are shielded from antenna field by a grounded metallic barrier. The MPE Radius is the minimum distance from the antenna axis that person should maintain in order to avoid RF exposure higher than the allowable MPE level set by FCC.

FAILURE TO OBSERVE THESE LIMITS MAY ALLOW THOSE WITHIN THE MPE RADIUS TO EXPERIENCE RF RADIATION ABSORPTION WHICH EXCEEDS THE FCC MAXIMUM PERMISSIBLE EXPOSURE (MPE) LIMIT. IT IS THE RESPONSIBILITY OF THE RADIO OPERATOR TO ENSURE THAT THE MAXIMUM PERMISSIBLE EXPOSURE LIMITS ARE OBSERVED AT ALL TIMES DURING RADIO TRANSMISSION. THE RADIO OPERATOR IS TO ENSURE THAT NO BYSTANDERS COME WITHIN THE RADIUS OF THE MAXIMUM PERMISSIBLE EXPOSURE LIMITS.

Determining MPE Radius

THE MAXIMUM PERMISSIBLE EXPOSURE (MPE) RADIUS HAS BEEN ESTIMATED TO BE A RADIUS OF ABOUT 3 M PER OET BULLETIN 65 OF THE FCC. THIS ESTIMATE IS MADE ASSUMING THE MAXIMUM POWER OF THE RADIO AND ANTENNAS WITH A MAXIMUM GAIN OF 9 dBi ARE USED FOR A SHIP MOUNTED SYSTEM.

AVERTISSEMENT POUR LES OPÉRATEURS RADIO



AVERTISSEMENT

Icom exige que l'opérateur radio se conforme aux exigences de la FCC en matière d'exposition aux radiofréquences. Une antenne omnidirectionnelle dont le gain ne dépasse pas 9 dBi doit être fixée à une distance minimale de 5 mètres (mesurée depuis le point le plus bas de l'antenne) verticalement au-dessus du pont principal et de tout le personnel qui peut s'y trouver. Il s'agit de la distance de sécurité minimale prévue pour satisfaire aux exigences de conformité en matière d'exposition aux RF. Cette distance de 5 mètres est établie en fonction de l'exposition maximale admissible sécuritaire de 3 mètres établie par la FCC, à laquelle on ajoute la hauteur d'un adulte (2 mètres); cette distance convient pour tous les navires.

Dans le cas des embarcations sans structure convenable, l'antenne doit être fixée de façon à maintenir une distance minimale de 1 mètre verticalement entre cette antenne (mesurée depuis son point le plus bas) et la tête de toute personne présente; toutes les personnes présentes doivent se tenir à l'extérieur d'un rayon d'exposition maximale admissible de 3 mètres.

Ne pas émettre à l'aide de la radio et de l'antenne lorsque des personnes se trouvent à l'intérieur du rayon d'exposition maximale admissible de cette antenne, à moins que ces personnes (comme le conducteur ou l'opérateur radio) ne soient protégées du champ de l'antenne par un écran métallique relié à la masse. Le rayon d'exposition maximale admissible équivaut à la distance minimale que cette personne doit maintenir entre elle et l'axe de l'antenne pour éviter une exposition aux RF supérieure au niveau d'exposition maximale admissible fixé par la FCC.

LE NON-RESPECT DE CES LIMITES PEUT CAUSER, POUR LES PERSONNES SITUÉES DANS LE RAYON D'EXPOSITION MAXIMALE ADMISSIBLE, UNE ABSORPTION DE RAYONNEMENT DE RF SUPÉRIEURE À L'EXPOSITION MAXIMALE ADMISSIBLE FIXÉE PAR LA FCC.

L'OPÉRATEUR RADIO EST RESPONSABLE D'ASSURER QUE LES LIMITES D'EXPOSITION MAXIMALE ADMISSIBLE SOIENT RESPECTÉES EN TOUT TEMPS PENDANT LA TRANSMISSION RADIO. L'OPÉRATEUR RADIO DOIT S'ASSURER QU'AUCUNE PERSONNE PRÉSENTE NE SE SITUE À L'INTÉRIEUR DU RAYON D'EXPOSITION MAXIMALE ADMISSIBLE.

**Établir le rayon d'exposition maximale admissible
ON ESTIME QUE LE RAYON D'EXPOSITION MAXIMALE ADMISSIBLE EST D'ENVIRON 3 M, TEL QUE STIPULÉ DANS LE BULLETIN OET 65 DE LA FCC. CETTE DISTANCE ESTIMÉE TIENT COMPTE D'UN SYSTÈME INSTALLÉ SUR UN NAVIRE UTILISANT LA PUISSANCE MAXIMALE DE LA RADIO ET DES ANTENNES DONT LE GAIN MAXIMAL EST DE 9 dBi.**

FCC INFORMATION

This equipment has been tested and found to comply with the limits for a Class A digital device, pursuant to part 15 of the FCC Rules. These limits are designed to provide reasonable protection against harmful interference when the equipment is operated in a commercial environment. This equipment generates, uses, and can radiate radio frequency energy and, if not installed and used in accordance with the instruction manual, may cause harmful interference to radio communications.

Operation of this equipment in a residential area is likely to cause harmful interference in which case the user will be required to correct the interference at his own expense.

CAUTION: Changes or modifications to this transceiver, not expressly approved by Icom Inc., could void your authority to operate this transceiver under FCC regulations.

INFORMATION FCC

Cet équipement a été testé et reconnu conforme aux limites fixées pour un appareil numérique de classe A, conformément au point 15 de la réglementation FCC. Ces limites sont définies de façon à fournir une protection raisonnable contre le brouillage préjudiciable lorsque cet appareil est utilisé dans un environnement commercial. Cet équipement génère, utilise et peut émettre un rayonnement de fréquence radio. S'il n'a pas été installé conformément aux instructions, il peut par ailleurs créer des interférences perturbant les communications radio. L'utilisation de cet appareil dans une zone résidentielle peut provoquer un brouillage préjudiciable, auquel cas l'utilisateur sera tenu de corriger la situation à ses frais.

MISE EN GARDE: Tout changement ou modification, non expressément approuvé par Icom Inc., peut annuler l'autorisation de l'utilisateur à utiliser cet appareil conformément à la réglementation FCC.

NOTE

A WARNING STICKER is supplied with the USA version transceiver.

To comply with FCC regulations, this sticker must be affixed in such a location as to be readily seen from the operating controls of the radio as in the diagram below. Make sure the chosen location is clean and dry before applying the sticker.

EXAMPLE



PRECAUTIONS

⚠ WARNING! NEVER connect the transceiver to an AC outlet. This may pose a fire hazard or result in an electric shock.

⚠ WARNING! NEVER connect the transceiver to a power source of more than 16 V DC such as a 24 V DC. This could cause a fire or damage the transceiver.

⚠ WARNING! NEVER reverse the DC power cable polarity when connecting to a power source. This could damage the transceiver.

⚠ WARNING! NEVER cut the DC power cable between the DC plug at the back of the transceiver and fuse holder. If an incorrect connection is made after cutting, the transceiver may be damaged.

⚠ WARNING! NEVER operate the transceiver during a lightning storm. It may result in an electric shock, cause a fire or damage the transceiver. Always disconnect the power source and antenna before a storm.

CAUTION: NEVER place the transceiver where normal operation of the vessel may be hindered or where it could cause bodily injury.

KEEP the transceiver and microphone at least 1 m away from the vessel's magnetic navigation compass.

DO NOT use or place the transceiver in areas with temperatures below -20°C (-4°F) or above $+60^{\circ}\text{C}$ ($+140^{\circ}\text{F}$) or, in areas subject to direct sunlight, such as the dashboard.

DO NOT use harsh solvents such as benzine or alcohol to clean the transceiver, as they will damage the transceiver's surfaces. If the transceiver becomes dusty or dirty, wipe it clean with a soft, dry cloth.

DO NOT disassemble or modify the transceiver for any reason.

BE CAREFUL! The transceiver rear panel will become hot when operating continuously for long periods of time. Place the transceiver in a secure place to avoid inadvertent use by children.

BE CAREFUL! The transceiver and the optional HM-195 COMMANDMICIV™ meet IPX7* requirements for waterproof protection. However, once the transceiver has been dropped, waterproof protection cannot be guaranteed because of possible damage to the transceiver's case or the waterproof seal.

* Except for the DC power connector, NMEA In/Out leads, and AF Out leads.

PRÉCAUTIONS

⚠ **AVERTISSEMENT! NE JAMAIS** connecter l'émetteur-récepteur à une alimentation CA au risque de provoquer un incendie ou un choc électrique.

⚠ **AVERTISSEMENT! NE JAMAIS** brancher l'émetteur-récepteur à une source d'alimentation de plus de 16 V CC, comme une source de 24 V CC. Cela pourrait causer un incendie ou endommager l'émetteur-récepteur.

⚠ **AVERTISSEMENT! NE JAMAIS** inverser la polarité du câble d'alimentation CC en le branchant à la source d'alimentation. Cela pourrait endommager l'émetteur-récepteur.

⚠ **AVERTISSEMENT! NE JAMAIS** sectionner le câble d'alimentation CC entre la prise CC de la face arrière de l'émetteur-récepteur et le porte-fusible. L'émetteur-récepteur peut être endommagé par la suite en cas de connexion inappropriée.

⚠ **AVERTISSEMENT! NE JAMAIS** utiliser l'émetteur-récepteur durant un orage. Cela risquerait de provoquer un choc électrique, un incendie ou d'endommager l'émetteur-récepteur. Toujours débrancher la source d'alimentation et l'antenne avant une tempête.

MISE EN GARDE: NE JAMAIS installer l'émetteur-récepteur à un emplacement où il pourrait gêner le fonctionnement normal du navire ou provoquer des blessures corporelles.

MAINTENIR l'émetteur-récepteur et le microphone à au moins 1 mètre du compas de route magnétique du navire.

NE PAS utiliser ou placer l'émetteur-récepteur dans des zones où la température est inférieure à -20° (-4°F) ou supérieure à $+60^{\circ}$ ($+140^{\circ}\text{F}$) ou dans des zones soumises au rayonnement solaire direct, telles le tableau de bord.

NE PAS nettoyer l'appareil avec des solvants agressifs tels que benzène ou alcool, susceptibles d'endommager les surfaces exposées du boîtier. En cas de dépôt de poussière ou de salissures sur l'émetteur-récepteur, il faut l'essuyer avec chiffon doux et sec.

NE PAS démonter ou modifier l'émetteur-récepteur pour quelque raison que ce soit.

ATTENTION! La face arrière de l'émetteur-récepteur chauffe en cas d'utilisation continue sur une longue durée.

Placer l'émetteur-récepteur hors de portée des enfants pour éviter toute utilisation inopinée.

ATTENTION! L'émetteur-récepteur et l'accessoire optionnel COMMANDMICIV^{MC} répondent aux exigences de l'indice d'étanchéité IPX7*. Cependant, cette étanchéité n'est plus garantie après une chute de l'appareil en raison des fissures du boîtier ou des dommages au joint d'étanchéité et autres dommages éventuels consécutifs à un tel incident.

* À l'exception du connecteur d'alimentation CC, des fils d'entrée ou de sortie NMEA et des fils de sortie de fréquences audio.

TABLE OF CONTENTS

PREFACE.....	i	4 BASIC OPERATION.....	11–18
IMPORTANT.....	i	■ Selecting a Channel.....	11
EXPLICIT DEFINITIONS.....	i	■ Receiving and transmitting.....	14
IN CASE OF EMERGENCY.....	ii	■ Adjusting the volume and squelch levels.....	15
INSTALLATION NOTE.....	ii	■ Entering a Call channel data.....	16
RADIO OPERATOR WARNING.....	iii	■ Entering a Channel name.....	16
AVERTISSEMENT POUR LES OPÉRATEURS RADIO.....	iv	■ Microphone Lock function.....	17
FCC INFORMATION.....	v	■ Adjusting the Backlight level.....	18
INFORMATION FCC.....	v	■ Using the AquaQuake water draining function.....	18
NOTE.....	v	5 SCAN OPERATION.....	19–20
PRECAUTIONS.....	vi	■ Scan types.....	19
PRÉCAUTIONS.....	vii	■ Setting Favorite channels.....	20
1 OPERATING RULES.....	1	■ Starting a scan.....	20
2 PANEL DESCRIPTION.....	2–8	6 DUALWATCH/TRI-WATCH.....	21
■ Front panel.....	2	■ Description.....	21
■ Function display.....	5	■ Operation.....	21
■ Softkey function.....	7		
■ Speaker Microphone.....	8		
3 PREPARATION.....	9–10		
■ Entering the MMSI code.....	9		
■ Entering the ATIS code (For Dutch and German version transceivers).....	10		

TABLE OF CONTENTS (continued)

7 DSC OPERATION	22–70	10 CONNECTIONS AND MAINTENANCE	84–90
■ DSC address ID	22	■ Connections	84
■ Entering position and time	25	■ Antenna.....	86
■ Making a Distress call	26	■ Fuse replacement	86
■ Making DSC calls.....	32	■ Cleaning.....	86
■ Receiving DSC calls	55	■ Supplied accessories	86
■ Transmitted Call log.....	62	■ Mounting the transceiver.....	87
■ Received Call log	63	■ MB-132 installation	88
■ DSC Settings	65	■ Microphone installation	89
■ Making an Individual call using an AIS transponder ..	69	11 SPECIFICATIONS AND OPTIONS	91–92
8 OTHER FUNCTIONS.....	71–73	■ Specifications	91
■ Using the Intercom.....	71	■ Options.....	92
■ Using the RX Speaker.....	72	12 CHANNEL LIST.....	93
■ Using the PA (Public Address)	72	13 TROUBLESHOOTING.....	94
■ Using the Horn	73	14 TEMPLATE	95
9 MENU SCREEN OPERATION	74–83	15 INFORMATION	97
■ Using the Menu screen	74	■ About CE and DOC.....	97
■ Menu screen items.....	75	■ Disposal	97
■ Radio Settings items	76	INDEX.....	98
■ Configuration items	78		

◇ Priorities

- Read all rules and regulations pertaining to call priorities, and keep an up-to-date copy handy. Safety and distress calls take priority over all others.
- You must monitor Channel 16 when you are not operating on another channel.
- False or fraudulent distress calls are prohibited under law.

◇ Privacy

- Information overheard, but not intended for you, cannot lawfully be used in any way.
- Indecent or profane language is prohibited.

◇ Radio licenses

(1) SHIP STATION LICENSE

You may require a current radio station license before using the transceiver. It is unlawful to operate a ship station which is not licensed, but required to be.

If required, contact your dealer or the appropriate government agency for a Ship-Radiotelephone license application. This government-issued license states the call sign which is your craft's identification for radio purposes.

(2) OPERATOR'S LICENSE

A Restricted Radiotelephone Operator Permit is the license most often held by small vessel radio operators when a radio is not required for safety purposes.

If required, the Restricted Radiotelephone Operator Permit must be posted or kept with the operator. If required, only a licensed radio operator may operate a transceiver.

However, non-licensed individuals may talk over a transceiver if a licensed operator starts, supervises, ends the call and makes the necessary log entries.

A current copy of the applicable government rules and regulations is only required to be on hand for vessels in which a radio telephone is compulsory. However, even if you are not required to have these on hand it is your responsibility to be thoroughly acquainted with all pertinent rules and regulations.

NOTE: Even though the transceiver is capable of operation on VHF marine channels 1021, 1023, 1081, 1082 and 1083, according to FCC regulations these simplex channels cannot be lawfully used by the general population in USA waters.

■ Front panel

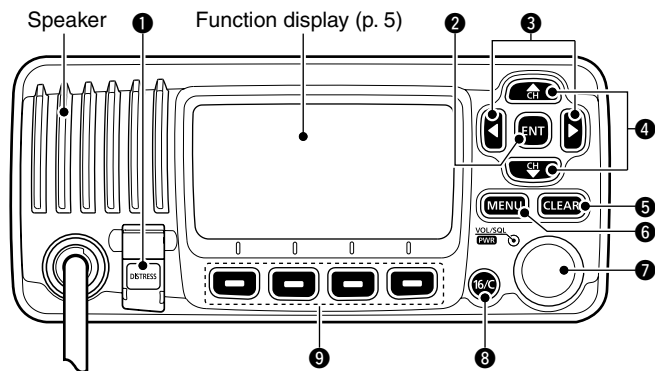

- 1 DISTRESS KEY [DISTRESS]** (pp. 26, 27)
Hold down for 3 seconds to make a Distress call.
- 2 ENTER KEY [ENT]** (pp. 9, 12, 74)
Push to set the entered data, selected item, and so on.
- 3 LEFT AND RIGHT KEYS [◀]/[▶]**
- ➔ Push to change to the previous or next key function that is assigned to the softkeys. (p. 7)
 - ➔ Push to select the desired character or number in the table while in the channel name, position, MMSI code entry mode, and so on. (pp. 9, 16, 25)

- 4 UP AND DOWN/CHANNEL SELECT KEYS [▲•CH]/[▼•CH]**
- ➔ Push to select the operating channels, Menu items, Menu settings, and so on. (pp. 14, 74)
 - ➔ While scanning, push to check Favorite channels, change the scanning direction or manually resume a scan. (p. 20)
- 5 CLEAR KEY [CLEAR]** (pp. 9, 16, 74)
Push to cancel the entered data, or to return to the previous screen.
- 6 MENU KEY [MENU]** (p. 74)
Push to enter or exit the Menu screen.
- 7 VOLUME AND SQUELCH SWITCH/POWER SWITCH [VOL/SQL•PWR]**
- ➔ When the power is OFF, hold down for 1 second to turn ON power. (p. 14)
 - ➔ Hold down for 1 second to turn OFF power.
 - ➔ When the power is ON, push to enter the volume level adjustment mode.* (p. 15)
 - Each push of this switch toggles the mode between the volume level adjustment, squelch threshold level adjustment, operating channel selection, and the LCD and key backlight brightness adjustment, if assigned.
 - ➔ Rotate to adjust the volume level.* (p. 15)
- *The desired function can be assigned in the Menu screen.

8 CHANNEL 16/CALL CHANNEL KEY [16/C]

- ➔ Push to select Channel 16. (p. 11)
- ➔ Hold down for 1 second to select the Call channel. (p. 11)
 - “CALL” is displayed when the Call channel is selected.
- ➔ When the Call channel is selected, hold down for 3 seconds to enter Call channel entry mode. (p. 16)

9 SOFTKEYS

Desired functions as described below can be assigned in the Menu screen.

Distress Call [DTRS] (For only USA version transceivers.)
 Push to enter “DISTRESS CALL” in the DSC menu to select the nature of the call, and then to make a call.

DSC [DSC] (For only USA version transceivers.)
 Push to enter the DSC menu to compose a DSC call.

Scan [SCAN] (p. 20)
 Push to start or stop a Normal or Priority scan.

Dualwatch/Tri-watch [DW] (p. 21)
 ➔ Push to start Dualwatch or Tri-watch.
 ➔ Push to stop Dualwatch or Tri-watch when either is activated.

High/Low [HI/LO] (p. 14)
 Push to set the power to high or low.
 •Some channels are set to only low power.

Channel/Weather channel [CHWX]* (pp. 11, 13)
 Push to selects and toggles the regular channel and Weather channel.
 *For only the USA and Australian version transceivers.

Channel [CHAN]* (p. 11)
 Push to select a regular channel.
 * For only the IC-M423, IC-M423G, and IC-M423GE except for Australian version transceivers.

Public address [PA] (p. 72)
 Push to enter the PA (Public Address) mode.

RX Speaker [RXSP] (p. 72)
 Push to turn the RX Speaker mode ON or OFF.

Horn [HORN] (p. 73)
 Push to enter the Horn mode.

Intercom [INCM] (p. 71)
 Push to enter the Intercom mode.

LO/DX [LODX]* (p. 14)
 Push to turn the Attenuator function ON or OFF.
 •“LOCAL” is displayed when the Attenuator function is ON.
 *For only the USA and Australian version transceivers.

AquaQuake [AQUA] (p. 18)
 Holding down to activate the AquaQuake to clear water away from the speaker grill.

2 PANEL DESCRIPTION

■ Front panel (Continued)

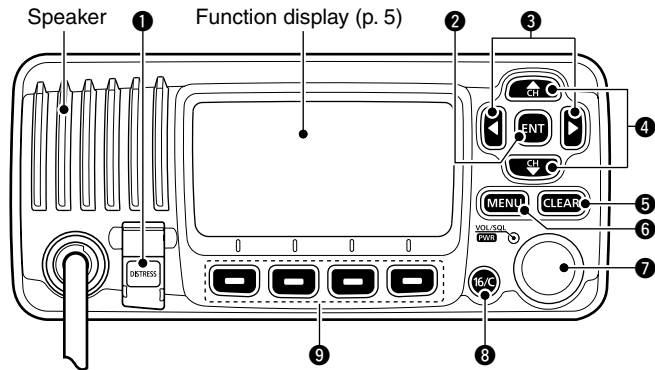

Favorite channel [] (p. 20)

- ➔ Push to set or clear the displayed channel as a Favorite (Tag) channel.
- ➔ Hold down for 3 seconds to clear or set all Favorite channels in the selected channel group.

Name [] (p. 16)

Push to enter the channel name entry mode.

Backlight [] (p. 18)

Push to enter the LCD and key backlight brightness adjustment mode.

- While in the adjustment mode, push [▲]/[▼]/[◀]/[▶] or rotate Dial to adjust the brightness of the LCD and key backlight.

Log [] (p. 63)

Push to enter "RCVD CALL LOG" in the DSC CALLS menu.

■ Function display

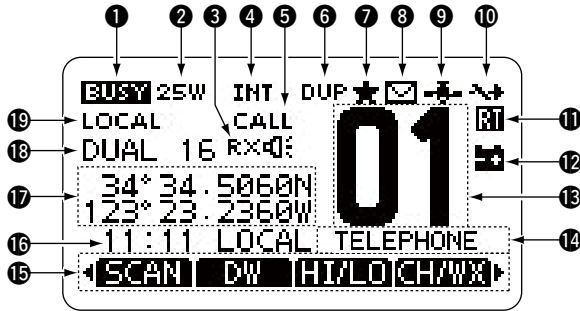

- ❶ **BUSY/TRANSMIT ICON** (p. 14)
 - “**BUSY**” is displayed when receiving a signal or when the squelch is open.
 - “**TX**” is displayed while transmitting.
- ❷ **POWER ICON** (p. 14)
 - “25W” is displayed when high power is selected.
 - “1W” is displayed when low power is selected.
- ❸ **RX SPEAKER ICON** (p. 72)
 - Displayed while in the RX Speaker mode.

- ❹ **CHANNEL GROUP ICON** (p. 12)
 - Shows which channel group is selected, INT, USA, CAN, ATIS or DSC, depending on the version.
 - “WX” is displayed when the weather channel is selected.*

*For only USA and Australian version transceivers.
- ❺ **CALL CHANNEL ICON** (p. 11)
 - Displayed when the Call channel is selected.
- ❻ **DUPLEX ICON** (p. 12)
 - Displayed when a duplex channel is selected.
- ❼ **FAVORITE CHANNEL ICON** (p. 20)
 - Displayed when a Favorite (Tag) channel is selected.
- ❽ **MESSAGE ICON** (p. 63)
 - Blinks when there is an unread DSC message.
- ❾ **GPS ICON**
 - Stays ON when the built-in GPS receiver* or an external GPS receiver is receiving valid position data.
 - *For only IC-M423G, IC-M423GE, and IC-M424G.
 - Blinks when searching for valid position data.
- ❿ **SWITCH ICON** (p. 66)
 - Displayed when the “CH 16 SWITCH” in DSC Settings is set to OFF.

2 PANEL DESCRIPTION

■ Function display (Continued)

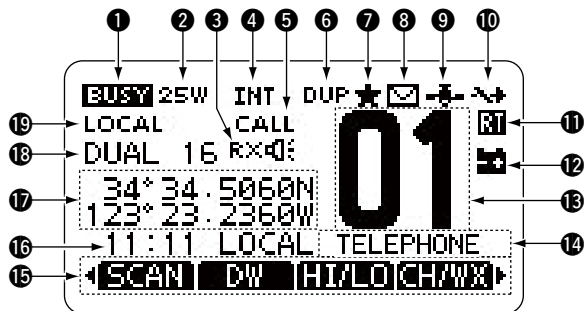

11 RT (Radio Telephone) ICON

(For only USA version transceivers.)

Displayed while in the Radio Telephone mode.

- The Radio Telephone mode is terminated if no operation occurs during the preset of time.
- The icon is displayed if the “RT Indicator:” item in the RADIO SET menu is set to “ON.” (p. 77)

12 LOW BATTERY ICON

Blinks when the battery voltage drops to approximately 10 V DC or less.

13 CHANNEL NUMBER READOUT

Shows the selected operating channel number.

14 CHANNEL NAME FIELD

The channel name is displayed, if entered. (p. 16)

15 KEY ICON (p. 7)

Shows the preset function of the softkeys on the front panel.

16 TIME ZONE INDICATOR

➤ Shows the current time when GPS data is received, or the time is manually entered.

- When the GPS current time is invalid, “??” will blink every 2 seconds instead of the current time. After 23.5 hours has passed, “NO TIME” is displayed.
- “??” will blink every 2 seconds instead of the current time, after 4 hours* have passed from when the time was manually entered. The manually entered time is held for only 23.5 hours, and after that, “NO TIME” is displayed.

*3 hours and 59 minutes for USA version.

- “LOCAL” is displayed when the offset time is set.
- “MNL” is displayed when the time is manually entered.
- “UTC” is displayed when the GGA, GLL or GNS GPS sentence format is included in the GPS signal.
- The date information is displayed when the RMC GPS sentence format is included in the GPS signal.
- “NO TIME” is displayed when no GPS receiver is connected, and no time is manually entered.

NOTE for the IC-M423 and IC-M424:

These models do not come with a built-in GPS receiver. Therefore an external GPS receiver needs to be connected, or the time needs to be manually entered for the time zone indicator to be displayed.

17 POSITION INDICATOR

- ➔ Shows the current position when position data is received, or the position is manually entered.
 - When the GPS position is invalid, “??” may blink every 2 seconds instead of position. The last position is held for only 23.5 hours, and after that, “NO POSITION” is displayed.
 - “??” will blink every 2 seconds instead of position, after 4 hours* have passed from the time when the position is manually entered. The manually entered position is held for only 23.5 hours, and after that, “NO POSITION” is displayed.
- *3 hours and 59 minutes for USA version.
- ➔ “NO POSITION” is displayed when no GPS receiver is connected, and no position is manually entered.

18 SCAN INDICATOR

- ➔ “SCAN 16” is displayed during a Priority scan; “SCAN” is displayed during a Normal scan. (p. 20)
- ➔ “DUAL 16” is displayed during Dualwatch; “TRI 16” is displayed during Tri-watch. (p. 20)

19 LOCAL ICON* (p. 14)

Displayed when the Attenuator function is turned ON.
 *For only USA and Australian version transceivers.

Softkey function

Various functions can be assigned to the softkeys. When a key function is assigned, the key icon is displayed above the softkey, as shown below.

Softkey function selection

When “◀” or “▶” is displayed beside the key icon, sequentially pushing [◀]/[▶] displays the previous or the next key function that is assigned to the softkey.

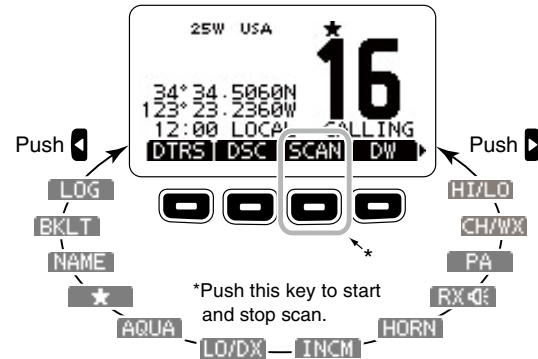

/// The order of the key icons may differ, depending on the version or presetting.

2 PANEL DESCRIPTION

■ Speaker Microphone

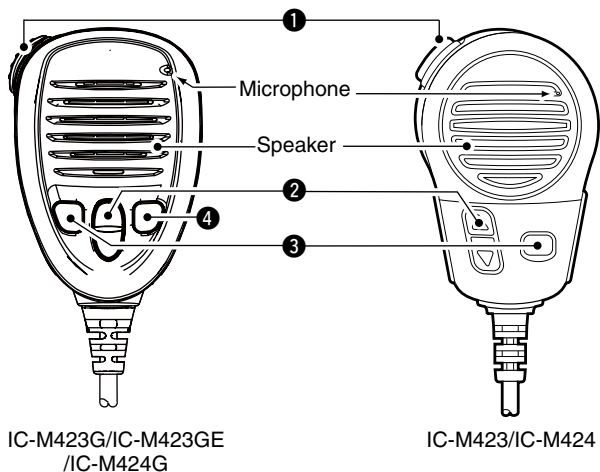

① PTT [PTT]

Hold down to transmit, release to receive. (p. 14)

② CHANNEL UP/DOWN KEYS [▲]/[▼]

Push either key to check Favorite channels, change scanning direction or manually resumes a scan. (pp. 14, 20)

③ TRANSMIT POWER KEY [H/L]*

- ➔ Push to toggle the power high or low. (p. 14)
 - Some channels are set to only low power.
- ➔ While holding down [H/L], turn ON the power to turn the Microphone Lock function ON or OFF. (p. 17)
 - *[HI/LO] is printed for the IC-M423/IC-M424.

④ CHANNEL 16/CALL CHANNEL KEY [16/C]

- ➔ Push to select Channel 16. (p. 11)
 - ➔ Hold down for 1 second to select the Call channel. (p. 11)
 - The “CALL” icon is displayed when the Call channel is selected.
- *For only the IC-M423G, IC-M423GE, and IC-M424G.

■ Entering the MMSI code

The 9 digit MMSI (Maritime Mobile Service Identity: DSC self ID) code can be entered at power ON.

This initial code setting can be made only once. After being set, it can be changed by only your dealer or distributor. If your MMSI code has already been entered, the following steps are not necessary.

- ① Hold down [PWR](Dial) to turn ON the power.
 - Three short beeps sound, and “NO DSC MMSI” is displayed.
- ② Push [ENT] to start the MMSI code entry.
 - Push [CLEAR] twice to cancel the entry, and go to the normal operating screen. In this case, the transceiver cannot make a DSC call. To enter the MMSI code, turn OFF the power, then turn it ON again.
- ③ Enter your MMSI code in the following way:
 - Select a desired number using Dial, or [▲]/[▼]/[◀]/[▶].
 - Push [ENT] or Dial to set it.
 - To move the cursor, select either arrow, “←” or “→,” then push [ENT] or Dial.

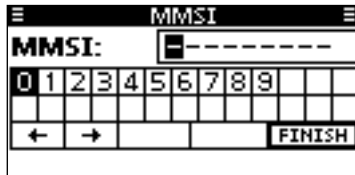

- ④ Repeat step ③ to enter all 9 digits.
- ⑤ After entering the 9 digit code, “FINISH” is automatically selected, and then push [ENT] or Dial to set it.
- ⑥ The “MMSI CONFIRMATION” screen is displayed.

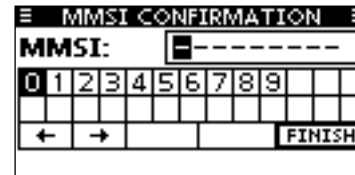

- ⑦ Enter your MMSI code again for confirmation.
 - Enter in the same way as steps ③ through ⑤.
- ⑧ When your MMSI code entry is successfully completed, the screen as shown below is briefly displayed.
 - After that, the normal operating screen is displayed.



The entered MMSI code can be checked in the MENU screen. (p. 74)

NOTE: Depending on the transceiver version, the ATIS code entry may be required after entering the MMSI code. See the next page for details.

3 PREPARATION

■ Entering the ATIS code (For Dutch and German* version transceivers)

The 10 digit ATIS (Automatic Transmitter Identification System) code can be entered at power ON.

This initial code setting can be made only once. After being set, it can be changed by only your dealer or distributor. If your ATIS code has already been entered, the following steps are not necessary.

- ① After entered the MMSI code, “Push [ENT] to Register Your ATIS” is displayed.
- ② Push [ENT] to start entering the ATIS code.
 - Push [CLEAR] twice to cancel the entry, and go to the normal operating mode. In this case, the ATIS function is disabled. To enter the ATIS code, turn OFF the power, then turn it ON again.
- ③ Enter your ATIS code in the following manner:
 - Select a desired number using Dial, or [▲]/[▼]/[◀]/[▶].
 - Push [ENT] or Dial to set it.
 - To move the cursor, select either arrow, “←” or “→,” then push [ENT] or Dial.

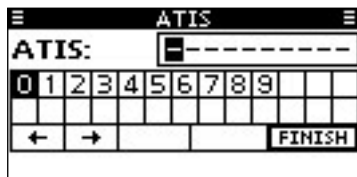

- ④ Repeat step ③ to enter all 10 digits.
- ⑤ After entering the 10 digit code, “FINISH” is automatically selected, and then push [ENT] or Dial to set it.
- ⑥ The “ATIS CONFIRMATION” screen is displayed.

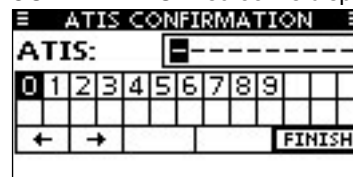

- ⑦ Enter your ATIS code again for confirmation.
 - Enter in the same manner as steps ③ through ⑤.
- ⑧ When your ATIS code is successfully entered, the screen as shown below is briefly displayed.
 - After that, the normal operating screen is displayed.



The entered ATIS code can be checked in the MENU screen. (p. 74)

* Presetting is required to use the ATIS mode in the German version. Contact your dealer for details.

■ Selecting a Channel

◇ Channel 16

Channel 16 is the distress and safety channel. It is used for establishing initial contact with a station and for emergency communications. Channel 16 is monitored during both Du-alwatch and Tri-watch. While standing by, you must monitor Channel 16.

- ➔ Push [16/C] to select Channel 16.
- ➔ Push [CH/WX]* to return to the screen displayed before you selected Channel 16, or push [▲]/[▼] to select an operating channel.

* [CHAN] is displayed instead of [CH/WX] for the IC-M423/IC-M423G/IC-M423GE except for Australian version.

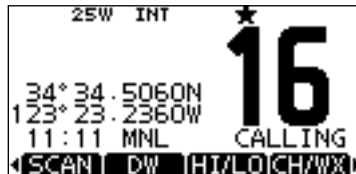

◇ Call channel

Each regular channel group has a separate leisure use Call channel. The Call channel is monitored during Tri-watch. The Call channel data can be entered. The channels used to store your most often used channel in each channel group, for quick recall. (p. 16)

- ➔ Hold down [16/C] for 1 second to select the Call channel of the selected channel group.
 - "CALL" and the Call channel number is displayed.
 - Each channel group has an independent call channel after entry. (p. 16)
- ➔ Push [CH/WX]* to return to the screen displayed before you selected Call channels, or push [▲]/[▼] to select an operating channel.

* [CHAN] is displayed instead of [CH/WX] for the IC-M423/IC-M423G/IC-M423GE except for Australian version.



4 BASIC OPERATION

■ Selecting a Channel (Continued)

◇ Selecting the Channel group

There are preset international channels in the IC-M423/IC-M423G/IC-M423GE/IC-M424/IC-M424G. Except for the European versions, you can select a channel group suitable for your operating area, as described below.

- ① Push [MENU].
- ② Rotate Dial or push [▲]/[▼] to select “Radio Settings,” and then push [ENT].
- ③ Rotate Dial or push [▲]/[▼] to select “CHAN Group,” and then push [ENT].



- ④ Rotate Dial or push [▲]/[▼] to select the desired channel group, and then push [ENT].
 - USA (USA), International (INT), CAN (Canada), ATIS or DSC channel groups may be selected, depending on the transceiver version.
 - Push [BACK] to return to the previous screen.



- ⑤ Push [EXIT] to exit the Menu screen.
- ⑥ Push [▲]/[▼] to select a channel.
 - Pushing [▲]/[▼] on the microphone selects only Favorite channels.
 - “DUP” is displayed when a duplex channel is selected.
 - “A” is displayed when a simplex channel is selected.

Channel group icon is displayed



When the USA channel group is selected.

◇ Selecting a Weather channel

(For only USA and Australian version transceivers)

The transceiver has 10 weather channels. These are used for monitoring broadcasts from NOAA. (National Oceanographic and Atmospheric Administration)

The transceiver can automatically detect a weather alert tone on the selected weather channel, or while scanning. (p. 19)

- ① Push [CH/WX] once or twice to select a weather channel.
 - “WX” is displayed when a weather channel is selected.
 - “WX ” is displayed when the Weather Alert function is ON. (p. 77)
- ② Push [▲]/[▼] to select a channel.
 - Pushing [▲]/[▼] on the microphone also selects a channel.

The Weather channel list

WX channel	Frequency (MHz)	
	Transmit	Receive
1	RX only	162.550
2	RX only	162.400
3	RX only	162.475
4	RX only	162.425
5	RX only	162.450
6	RX only	162.500
7	RX only	162.525
8	RX only	161.650
9	RX only	161.775
10	RX only	163.275

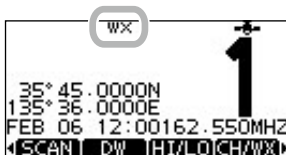

When weather alert is OFF.

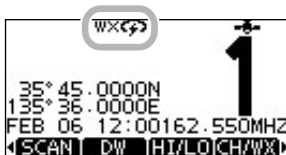

When weather alert is ON.

4 BASIC OPERATION

■ Receiving and transmitting

⚡ **CAUTION: DO NOT** transmit without an antenna.

- ① Hold down [PWR](Dial) to turn ON the power.
- ② Set the audio and squelch levels. (p. 15)
 - ➔ First, open the squelch. Then, adjust the audio output level. After that, adjust the squelch level until the noise just disappears.
- ③ Change the channel group. (p. 12)
- ④ Push [▲]/[▼] to select a channel. (pp. 11, 12)
 - Pushing [▲]/[▼] on the microphone selects only Favorite channels.
 - When receiving a signal, "BUSY" is displayed and audio is heard.
 - Further adjustment of the volume level may be necessary.
- ⑤ Push [LO/DX] to turn the receive Attenuator function ON or OFF, if necessary.
 - For only USA and Australian version transceivers.
 - "LOCAL" is displayed when the receive Attenuator function is ON.
- ⑥ Push [HI/LO] to select the output power, if necessary.
 - Pushing [H/L] or [HI/LO] on the microphone also select the output power.
 - "25W" is displayed when high power is selected, and "1W" is displayed when low power is selected.
 - Choose low power for short range communications, choose high power for longer distance communications.
 - Some channels are for only low power.

- ⑦ Hold down [PTT] to transmit, then speak at your normal voice level.
 - "TX" is displayed.
 - Channel 70 cannot be used for transmission other than DSC.
- ⑧ Release [PTT] to receive.

✓ Information

The Noise Cancel function reduces random noise components in the transmit and/or receive signal. See page 80 for details.

⚡ Simplex channels, 3, 21, 23, 61, 64, 81, 82, and 83 **CAN-**NOT be lawfully used by the general public in USA waters.

⚡ **IMPORTANT:** To maximize the readability of your transmitted signal, pause a few seconds after pushing [PTT], hold the microphone 5 to 10 cm (2 to 4 inches) from your mouth and speak at a normal voice level.

✓ NOTE for the TOT (Time-out Timer) function

The TOT function inhibits continuous transmission beyond a preset time period after the transmission starts. 10 seconds before transmission is cutoff, a beep sounds to indicate the transmission will be shut down and "TOT" is displayed in the channel name field. Transmission is not possible for 10 seconds after this shut down.

■ Adjusting the volume and squelch levels

The volume and squelch levels can be adjusted with [VOL/SQL](Dial).

- ① Push [VOL/SQL](Dial) one or more times to display the volume or squelch adjustment screen.
- ② Rotate [VOL/SQL](Dial) or push [▲]/[▼]/[◀]/[▶] to adjust the volume or squelch level.
 - The transceiver has 20 volume levels and OFF.
 - The transceiver has 11 squelch levels. OPEN is completely open, 10 is tight squelch, 1 is loose squelch.
 - If no key is push for about 5 seconds, the transceiver sets the selected volume level, and returns to the normal mode.
- ③ Push [ENT] to set the level, and exit the volume adjustment mode.
 - Push [CLEAR] to cancel.

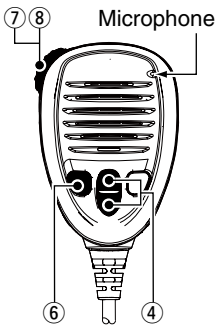
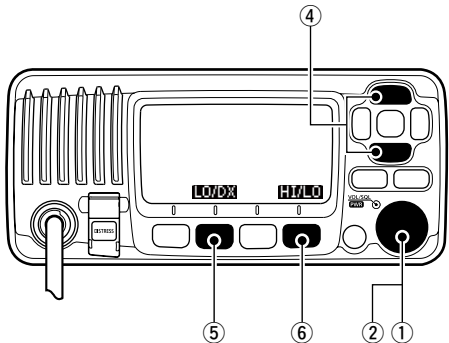

IC-M423G/IC-M423GE
/IC-M424G

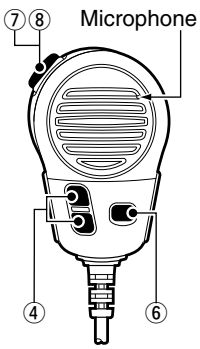

IC-M423/IC-M424

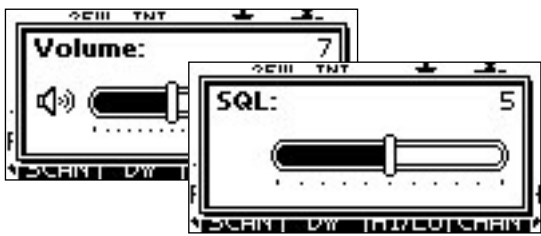

▨ The desired function can be assigned to Dial. See page 79 for details.

4 BASIC OPERATION

■ Entering a Call channel data

You can enter data in Call channel in each channel group for quick recall.

- ① Select the desired channel group (INT, USA, CAN, ATIS, or DSC) to be entered. (p. 12)
- ② Hold down [16/C] for 1 second to select the Call channel of the selected channel group.
 - "CALL" and the Call channel number is displayed.
- ③ Hold down [16/C] again for 3 seconds (until a long beep changes to 2 short beeps) to enter the Call channel entry mode.
- ④ Rotate Dial or push [▲]/[▼] to select a channel.



- ⑤ Push [ENT] to save the displayed channel as the Call channel.
 - Push [CLEAR] to cancel.

■ Entering a Channel name

Enter a name of up to 10 characters.

Capital letters, 0 to 9, some symbols, (! " # \$ % & ' () * + , - . / [\] ^ _ : ; < = > ?) and a space can be entered.

- ① Push [▲]/[▼](CH) to select a channel.
 - First, cancel the Dualwatch, Tri-watch or Scan function, if activated.
- ② Push [NAME] to open the channel name enter screen.
 - A cursor is displayed on the first character.
- ③ Enter the desired channel name in the following manner:
 - Select a desired character using Dial, or [▲]/[▼]/[◀]/[▶].
 - Push [ENT] or Dial to set it.
 - To move the cursor, select either arrow, "←" or "→," then push [ENT] or Dial.
 - Push [123], [!\$?], or [ABC] to select a character group.
 - Select "SPACE," then push [ENT] to enter a space.
 - Select "DELETE," then push [ENT] to delete a character.
 - Push [CLEAR] to cancel and return to the previous screen.



- ④ Repeat step ③ to enter all characters.



- ⑤ Push [◀]/[▶]/[▲]/[▼] to select "FINISH," then push [ENT] to set the name and return to the previous screen.



Microphone Lock function

The Microphone Lock function electrically locks [▲], [▼], [16/C],*¹ and the [H/L]*² keys on the supplied microphone. This prevents accidental channel changes and function access.

*¹For only the IC-M423G, IC-M423GE, and IC-M424G.

*²[HI/LO] is printed for the IC-M423 and IC-M424.

- While holding down [H/L] or [HI/LO] on the microphone, hold down [PWR](Dial) to turn ON the transceiver and turn the Microphone Lock function ON or OFF.

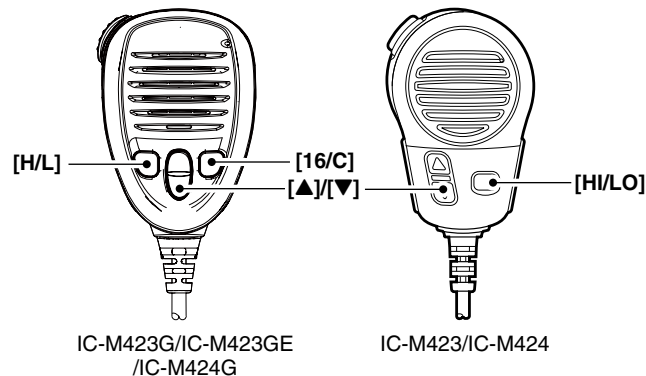

4 BASIC OPERATION

■ Adjusting the Backlight level

The function display and keys can be backlit for better visibility under low light conditions.

The backlight is adjustable in 7 levels and OFF.

The adjustment method, described below differs depending on the presetting.

➔ Push [BKLT] to show the backlight adjustment screen. Rotate Dial or push [▲]/[▼]/[◀]/[▶] to adjust the brightness of the LCD and key backlight, and then, push [ENT].

- If no key operation is performed for about 5 seconds, the transceiver sets the selected backlight level, and returns to the normal mode.

When the Backlight function is assigned to the [VOL/SQL](Dial):

- ① Push [VOL/SQL](Dial) one or more times to display the backlight adjustment screen.
- ② Rotate [VOL/SQL](Dial) to adjust the brightness of the LCD and key backlight, and then, push [ENT].



/// The desired function can be assigned to Dial. See page 79 for details.

■ Using the AquaQuake water draining function

The AquaQuake water draining function clears water away from the speaker grill. Without this function, water may muffle the sound coming from the speaker. A buzzing sound is heard when this function is activated.

- ➔ While holding down [AQUA], the AquaQuake function is activated to clear water away from the speaker grill.
- While holding down [AQUA], a low buzzing sounds to drain water, regardless of the volume level setting.
 - The transceiver keys, except [DISTRESS], are disabled while the AquaQuake function is activated.



When the AquaQuake function is activated.

■ Scan types

Scanning is an efficient way to locate signals quickly over a wide frequency range. The transceiver has a Priority scan and a Normal scan.

When the Weather Alert function* is ON, the weather channel is also checked while scanning. (p. 77)

*For only USA and Australian version transceivers.

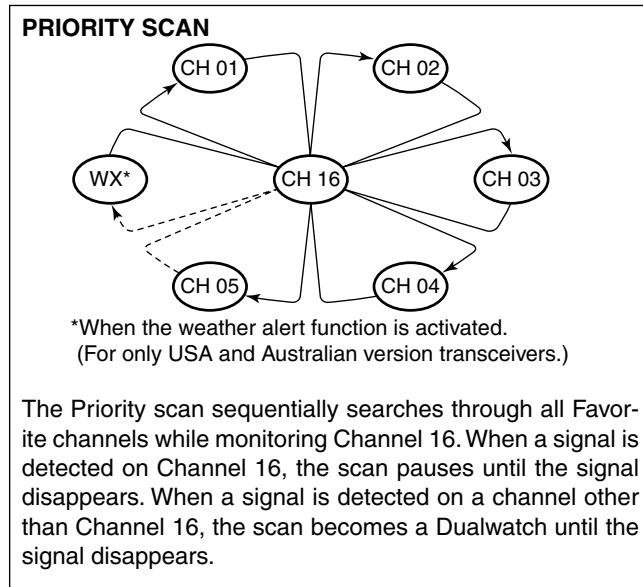

Set the Favorite channels (scanned channel) before scanning. Clear the Favorite channels which inconveniently stop scanning, such as those for digital communication use. (Refer to the next page for details.)

☞ Choose Priority or Normal scan in the Menu screen. (p. 76)

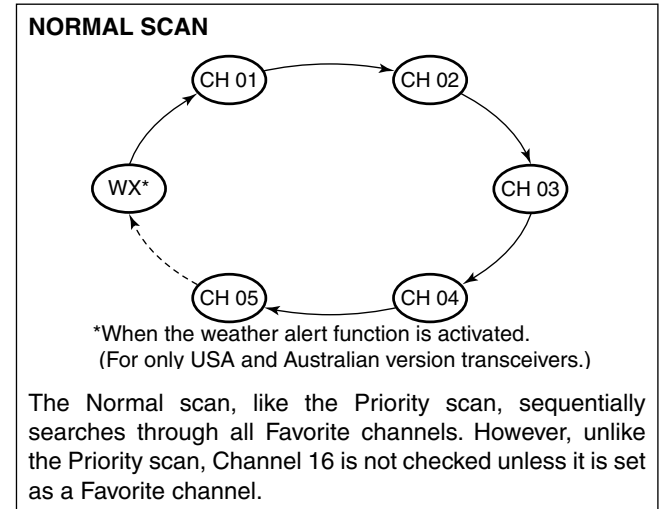

5 SCAN OPERATION

■ Setting Favorite channels

For more efficient scanning, add desired channels as Favorite channels, or clear the Favorite on unwanted channels. Channels that are not tagged will be skipped while scanning. Favorite channels can be independently assigned to each channel group (INT, USA, CAN, ATIS, or DSC).

- ① Select the desired channel group. (p. 12)
- ② Select the desired channel to be set as a Favorite channel.
- ③ Push [★] to set the displayed channel as a Favorite channel.
 - “★” is displayed on the display.
- ④ To cancel the Favorite channel setting, repeat step ③.
 - “★” disappears.

✓ Clearing (or setting) all Favorite channels

Hold down [★] for 3 seconds (until a long beep changes to 2 short beeps) to clear all Favorite channel settings in the selected channel group.

- Repeat above procedure to set all channels as Favorite channels.

■ Starting a scan

First, set the scan type (Priority or Normal scan) and scan resume timer in the Menu screen. (p. 76)

- ① Select the desired channel group. (p. 12)
- ② Set the Favorite channels, as described to the left.
- ③ Make sure the squelch is closed to start a scan.
- ④ Push [SCAN] to start a Priority or Normal scan.
 - “SCAN 16” is displayed during a Priority scan; “SCAN” is displayed during a Normal scan.
 - When a signal is detected, the scan pauses until the signal disappears, or resumes after pausing 5 seconds, depending on the setting. (Channel 16 is still monitored during a Priority scan.)
 - Push [▲]/[▼] on either transceiver or microphone, to check the scanning Favorite channels, change the scanning direction or manually resume the scan.
 - A beep tone sounds and “16” blinks when a signal is received on Channel 16 during a Priority scan.
- ⑤ To stop the scan, push [CLEAR] or repeat step ④.

[Example]: Starting a Normal scan.



Push
[SCAN]

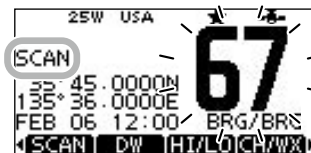

→

When a signal is received.



■ Description

Dualwatch monitors Channel 16 while you are receiving on another channel; Tri-watch monitors Channel 16 and the Call channel while receiving another channel. Dualwatch and Tri-watch are convenient for monitoring Channel 16 when you are operating on another channel.

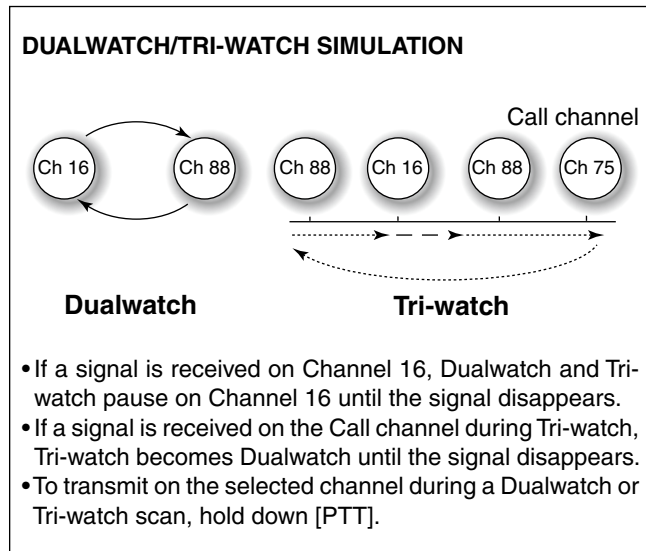

■ Operation

- ① Select Dualwatch or Tri-watch in the Menu screen. (p. 76)
- ② Push [▲]/[▼] to select the desired operating channel.
- ③ Push [DW] to start a Dualwatch or Tri-watch scan.
 - “DUAL 16” is displayed during Dualwatch; “TRI 16” is displayed during Tri-watch.
 - A beep tone sounds when a signal is received on Channel 16.
- ④ To cancel Dualwatch or Tri-watch, push [DW] again.

[Example]: Operating Tri-watch on INT Channel 25.

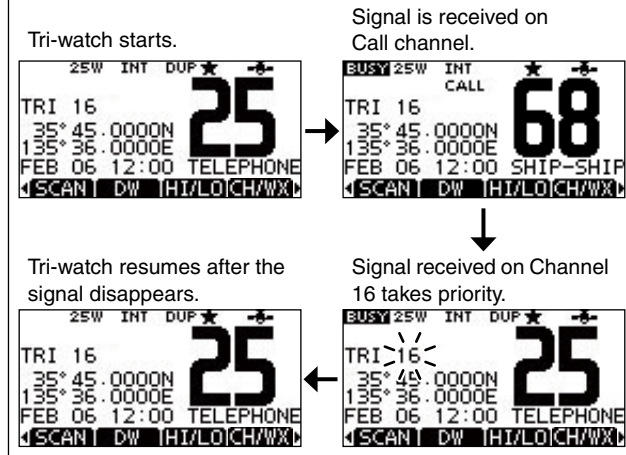

■ DSC address ID

◇ Entering an Individual ID

A total of 100 DSC address IDs can be entered and assigned a name of up to 10 characters.

- ① Enter "INDIVIDUAL ID" in the DSC SETTINGS menu.

◀MENU▶ ⇄ ▶DSC Settings▶ ⇄ ▶Individual ID▶
(Push [MENU].) (Rotate Dial, then push [ENT].)

- ② Push [ADD].

• The "INDIVIDUAL ID" entry screen is displayed.

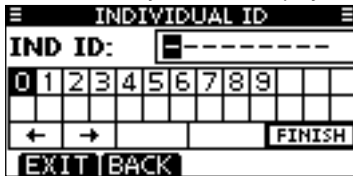

- ③ Enter a desired individual ID in the following way:

- Select a desired number using Dial, or [▲]/[▼]/[◀]/[▶].
- Push [ENT] or Dial to set it.
- To move the cursor, select either arrow, "←" or "→," then push [ENT] or Dial.

▨ The first digit is specified as '0,' and the second digit is other than '0' for a Group ID.

▨ The first two digits are '0' for any Coast station ID.

- ④ Repeat step ③ to enter all 9 digits.

- ⑤ After entering the 9 digit code, push [ENT] or Dial to set it.
• The ID name entry screen is displayed.



- ⑥ Enter a desired 10 digit ID name in the following way:

- Select a desired character using Dial, or [▲]/[▼]/[◀]/[▶].
- Push [ENT] or Dial to set it.
- To move the cursor, select either arrow, "←" or "→," then push [ENT] or Dial.
- Push [123], [!\$?], or [ABC] to select a character group.

- ⑦ After entering the ID name, select "FINISH" using Dial, or [▲]/[▼]/[◀]/[▶], then push [ENT] or Dial to set it.
• The "INDIVIDUAL ID" list screen is displayed.



- ⑧ Push [MENU] to exit the MENU screen.

◆ Entering a Group ID

- ① Enter “GROUP ID” in the DSC SETTINGS menu.

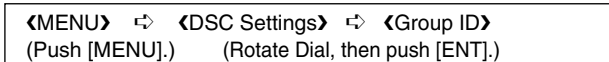

- ② Push [ADD].

- The “GROUP ID” entry screen is displayed.



- ③ Enter a desired group ID in the following way:

- Select a desired number using Dial, or [▲]/[▼]/[◀]/[▶].
- Push [ENT] or Dial to set it.
- To move the cursor, select either arrow, “←” or “→,” then push [ENT] or Dial.
- Push [EXIT] to return to the normal operating mode.
- Push [BACK] to return to the previous screen.

▨ The first digit is specified as ‘0,’ and the second digit is other than ‘0’ for a Group ID.

▨ The first two digits are ‘0’ for any Coast station ID.

- ④ Repeat step ③ to enter the specific 9 digits group code.

- ⑤ After entering the 9 digit code, push [ENT] or Dial to set it.
- Group ID name entry screen is displayed.



- ⑥ Enter a desired 10 digit ID name in the following way:

- Select a desired character using Dial, or [▲]/[▼]/[◀]/[▶].
- Push [ENT] or Dial to set it.
- To move the cursor, select either arrow, “←” or “→,” then push [ENT] or Dial.
- Push [123], [!\$?], or [ABC] to select a character group.

- ⑦ After entering the ID name, select “FINISH” using Dial, or [▲]/[▼]/[◀]/[▶], then push [ENT] or Dial to save it.
- The “GROUP ID” list screen is displayed.



- ⑧ Push [MENU] to exit the MENU screen.

7 DSC OPERATION

■ DSC address ID (Continued)

◆ Deleting Individual and Group IDs

- ① Enter "INDIVIDUAL ID" or "GROUP ID" in the DSC SETTINGS menu.

◀MENU▶ ⇔ ▶DSC Settings◀ ⇔ ▶Individual ID◀/▶Group ID◀
(Push [MENU].) (Rotate Dial, then push [ENT].)

• When no address ID is entered, "No ID" is displayed. In this case, push [MENU] to exit the MENU screen.

- ② Rotate Dial or push [▲]/[▼] to select a desired ID name, then push [DEL].



- ③ Push [OK] to delete the ID, and return to the "INDIVIDUAL ID" or "GROUP ID" list screen.

- Push [CANCEL] to cancel it.



- ④ Push [MENU] to exit the MENU screen.

■ Entering position and time

A Distress call should include the ship's position and time. If no GPS receiver is connected and built-in GPS receiver* is not receiving valid position data, your position and UTC (Universal Time Coordinated) time should be manually entered. They are automatically included when a GPS receiver compatible with the NMEA 0183 (ver. 2.0 or later) format is connected.

*For only the IC-M423G, IC-M423GE, and IC-M424G.

- ▨ Manual entry is disabled when a GPS receiver is connected.
- ▨ Manually entered position and time will be held for only 23.5 hours.

① Enter "POSITION INPUT" in the DSC SETTINGS menu.

◀[MENU] ⇄ ◀[DSC Settings] ⇄ ◀[Position Input]
 (Push [MENU].) (Rotate Dial, then push [ENT].)

② Enter your latitude and longitude position using Dial, or [▲]/[▼]/[◀]/[▶].

- Select a desired number using Dial, or [▲]/[▼]/[◀]/[▶].
- Push [ENT] or Dial to set it.
- To move the cursor, select either arrow, "←" or "→," then push [ENT] or Dial.
- Select N (North latitude) or S (South latitude) when the cursor is on the 'N' or 'S' position.
- Select W (West longitude) or E (East longitude) when the cursor is on the 'W' or 'E' position.

- Push [EXIT] to return to the normal operating mode.
- Push [BACK] to return to the previous screen.



- ③ After entering the position, push [ENT] to save it.
- ④ The UTC time entry screen is displayed, enter the UTC time in the following way:
- Select a desired number using Dial, or [▲]/[▼]/[◀]/[▶].
 - Push [ENT] or Dial to set it.
 - To move the cursor, select either arrow, "←" or "→," then push [ENT] or Dial.

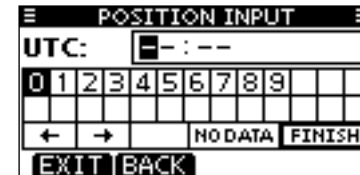

- ⑤ Push [ENT] or Dial to save your position and time.
- Return to the "DSC SETTINGS" screen.

■ Making a Distress call

A Distress call should be made if, in the opinion of the Master, that the ship or a person is in distress and requires immediate assistance.

NEVER MAKE A DISTRESS CALL IF YOUR SHIP OR A PERSON IS NOT IN AN EMERGENCY. A DISTRESS CALL SHOULD BE MADE ONLY WHEN IMMEDIATE HELP IS NEEDED.

◇ Simple call

- ① While lifting up the key cover, hold down [DISTRESS] for 3 seconds to transmit the Distress call.
 - While holding down [DISTRESS], count down beeps sound and both the key and display backlighting blink.
 - DSC channel (Channel 70) is automatically selected and the Distress call is transmitted.

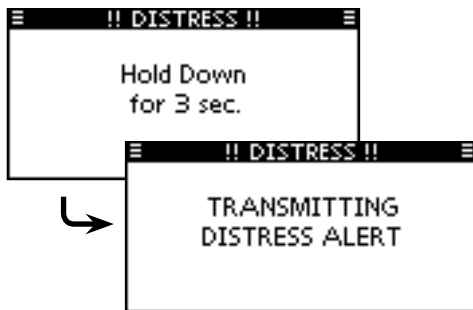

- ② After transmitting the call, the transceiver waits for an acknowledgment call.
 - The Distress call is automatically transmitted every 3.5 to 4.5 minutes, until an acknowledgement is received ('Call repeat' mode), or DSC Cancel call is made. (p. 29)
 - Push [RESEND] to manually transmit the Distress repeat call.
 - Push [◀]/[▶] then push [INFO] to display the transmitted Distress call information.
 - Push [◀]/[▶] then push [PAUSE] to pause the 'Call repeat' mode, push [RESUME] to resume it.



- ③ After receiving the acknowledgment, push [ALARM OFF] then reply using the microphone.
- ➔ A distress alert default contains:
- Nature of distress: Undesignated distress
 - Position information: The latest GPS or manually entered position is held for 23.5 hours, or until the power is turned OFF.

◇ Making a Regular call

The nature of the Distress call should be included in the Distress call.

- ① Enter "DISTRESS CALL" in the DSC CALLS menu.*

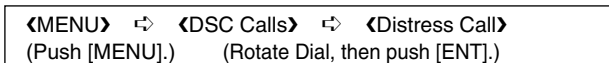

* Only USA version, you can enter "DISTRESS CALL" by pushing [DTRS].

- ② Select the nature of the distress using Dial or [▲]/[▼], then push Dial or [ENT].
 - 'Undesignated,' 'Fire,Explosion,' 'Flooding,' 'Collision,' 'Grounding,' 'Capsizing,' 'Sinking,' 'Adrift,' 'Abandoning ship,' 'Piracy' or 'Man Overboard' are selectable.
 - The nature of the distress is stored for 10 minutes after selecting.
 - Push [EXIT] to return to the normal operating mode.
 - Push [BACK] to return to the previous screen.

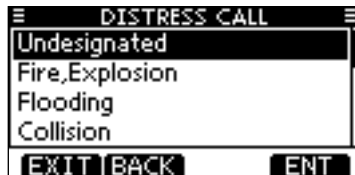

- ③ The Distress call confirmation screen is displayed.
 - Rotate Dial or push [▲]/[▼] to see the hidden lines.

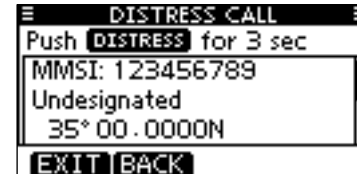

- ④ Hold down [DISTRESS] for 3 seconds to transmit the Distress call.
 - While holding down [DISTRESS], count down beeps sound and both the key and display backlighting blink.
 - The selected nature of the distress is stored for 10 minutes.



7 DSC OPERATION

■ Making a Distress call (Continued)

⑤ After transmitting the call, the transceiver waits for an acknowledgment call.

- The Distress call is automatically transmitted every 3.5 to 4.5 minutes, until an acknowledgement is received ('Call repeat mode'), or DSC cancel call is made. (p. 29)
- Push [RESEND] to manually transmit the Distress repeat call.
- Push [◀]/[▶] then push [INFO] to display the transmitted Distress call information.
- Push [◀]/[▶] then push [PAUSE] to pause the 'Call repeat' mode, push [RESUME] to resume it.



⑥ After receiving an acknowledgment call, push [ALARM OFF] then reply using the microphone.



➤ A distress alert contains:

- Nature of distress: Selected in step ②.
- Position information: The latest GPS or manually entered position is held for 23.5 hours, or until the power is turned OFF.

When no GPS receiver is connected and built-in GPS receiver* is not receiving valid position data, and both position and time have been manually entered, the screen as shown below is displayed. Edit your latitude and longitude position and UTC time as follows:

*For only the IC-M423G, IC-M423GE, and IC-M424G.

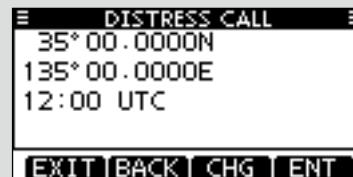

➤ Push [CHG], then edit your latitude and longitude position and UTC time.

- Select a desired number using Dial, or [▲]/[▼]/[◀]/[▶].
- Push [ENT] or Dial to set it.
- To move the cursor, select either arrow, “←” or “→,” then push [ENT] or Dial.
- Select N (North latitude) or S (South latitude) when the cursor is on the ‘N’ or ‘S’ position.
- Select W (West longitude) or E (East longitude) when the cursor is on the ‘W’ or ‘E’ position.



◇ Canceling a Distress call

- ① While waiting for an acknowledgment call, push [CANCEL].



- ② Push [CONTINUE].

- Push [BACK] to return to waiting for an acknowledgement call.



- ③ Push [FINISH].

- Push [EXIT] to return to waiting for an acknowledgement call.



- ④ The Distress cancel call is transmitted.



- ⑤ Channel 16 is automatically selected.

- Report your situation using the microphone.
- After the report, push [EXIT] to return to the normal operating mode.*
- Only USA version, push [RESEND] to resend the call.



* Only USA version, the exit confirmation dialog is displayed.

7 DSC OPERATION

◇ Making a Distress Relay Acknowledgement

(For only USA version transceivers)

When receiving a Distress Relay Call, you can transmit an acknowledgement, as shown below.

- ① When a Distress Relay Call is received, alarm sounds and the screen shown below is displayed.
Push [ALARM OFF] to stop the alarm.
 - Even if you do not push [ALARM OFF], the alarm stops after 2 minutes, and then the screen in step ② is displayed.



- ② Push [ACPT].
 - Even if you do not push [ACPT], the screen in step ③ is displayed after 10 seconds.
 - Push [IGN] to ignore the call and return to the normal operating mode.
 - Push [INFO] to display the Distress Relay Call information.
 - Push [PAUSE] to pause the countdown.



About Received call information:

- Push [IGN] to ignore the call and return to the normal operating mode.
- Push [BACK] to return to the previous screen.
- Push [ACPT] to go to the next step.

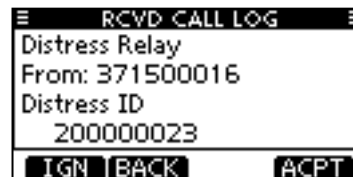

- ③ Push [ACK].
 - Push [EXIT] to return to the normal operating mode.*

*The exit confirmation dialog is displayed.

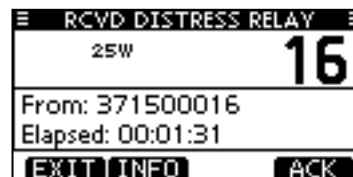

- ④ The Distress Relay Acknowledgement confirmation screen is displayed.

Push [CALL] to transmit the acknowledgement call.

- Push [EXIT] to return to the normal operating mode.*

*The exit confirmation dialog (p. 29) is displayed.

- Push [BACK] to return to the previous screen.

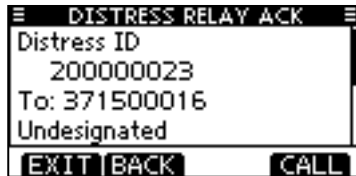

- ⑥ Channel 16 is automatically selected.

- Push [EXIT] to return to the normal operating mode.*

*The exit confirmation dialog (p. 29) is displayed.

- Push [RESEND] to resend the acknowledgement.

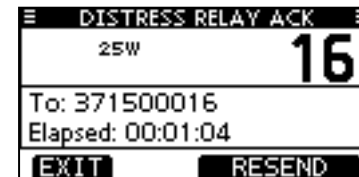

- ⑤ The Distress Relay Acknowledgement is transmitted.

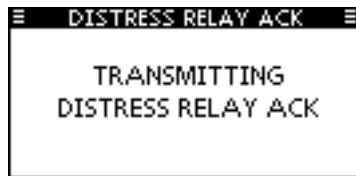

■ Making DSC calls

▨ To ensure correct operation of the DSC function, make sure you correctly set the CH70 SQL LEVEL. (p. 67)

◇ Making an individual call

The Individual call function allows you to make a DSC call to only a specific station.

- ① Enter "INDIVIDUAL CALL" in the DSC CALLS menu.

◀MENU▶ ⇄ ▶DSC Calls▶ ⇄ ▶Individual Call▶
 (Push [MENU].) (Rotate Dial, then push [ENT].)

- ② Select a desired preset individual address, or "Manual Input," using Dial or [▲]/[▼], then push Dial or [ENT].
 - The ID code for the Individual call can be entered first. (p. 22)
 - When "Manual Input" is selected, enter a desired 9 digit MMSI ID code for the individual you wish to call.
 - Push [EXIT] to return to the normal operating mode.
 - Push [BACK] to return to the previous screen.

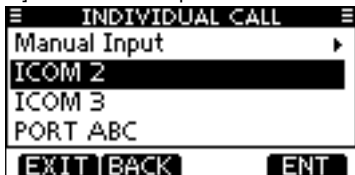

▨ About Manual Entry:

Enter a desired individual ID in the following way:

- Select a desired number using Dial, or [◀]/[▶].
- Push [ENT] or Dial to set it.
- To move the cursor, select either arrow, "←" or "→," then push [ENT] or Dial.
- The first digit is specified as '0' for a Group ID. If a 9 digit Group ID is entered, an error beep sounds when pushing [ENT] or dial.
- The first two digits are '0' for any coast station ID.



▨ **NOTE:** When a coast station is selected in step ②, the voice channel is automatically specified by the coast station. Therefore, skip step ③ and go directly to step ④.

- ③ Select a desired intership channel using Dial or [▲]/[▼], then push [ENT].
- Intership channels are already preset into the transceiver in the recommended order.

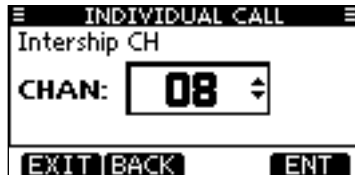

- ④ A confirmation screen is displayed.
- Confirm the call contents.

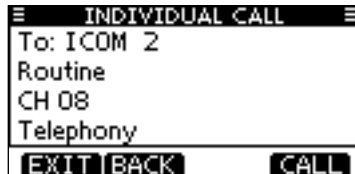

- ⑤ Push [CALL] to make an Individual call.
- If Channel 70 is busy, the transceiver stands by until the channel becomes clear.

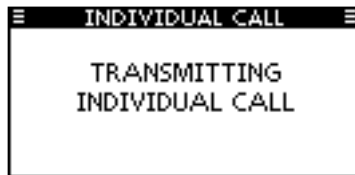

- ⑥ Standby on Channel 70 until an acknowledgement is received.
- Push [EXIT] to return to the normal operating mode.*
 - * Only USA version, the exit confirmation dialog (p. 29) is displayed.
 - Only USA version, push [RESEND] to resend the call.

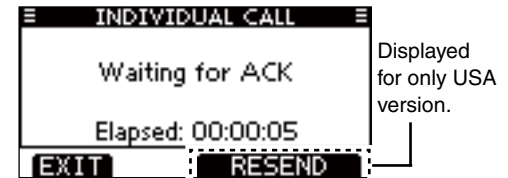

- ⑦ When the acknowledgement 'Able to comply' is received, alarm sounds and the screen below is displayed.



- Push [ALARM OFF] to stop the alarm and then select the intership channel specified in step ③.
- A different intership channel will be selected if the station you called cannot use the channel.
 - Reply using the microphone. And go to step ⑧.

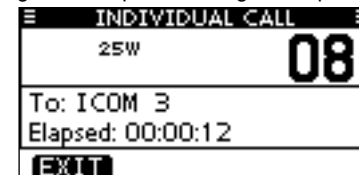

7 DSC OPERATION

■ Making DSC calls

◇ Making an Individual call (continued)

Or, when the acknowledgement 'Unable to comply' is received, alarm sounds and the screen below is displayed.



Push [ALARM OFF] to stop the alarm. Then push [EXIT] to return to the operating channel (before you entered the MENU screen).

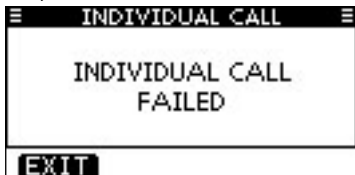

⑧ After communicating, push [EXIT] to return to the normal operating mode.

✓ Tip

When the optional MA-500TR/MA-510TR* CLASS B AIS TRANSPONDER is connected to your transceiver, you can make individual DSC calls to selected AIS targets on the transponder without needing to enter the target's MMSI code.

See pages 69 and 70 for more details.

* Unreleased as of April 2020.

◇ Making an Individual Acknowledgement

When you receive an Individual call, you can make an acknowledgement ('Able to Comply,' 'Propose New Channel,' or 'Unable to Comply') by using the on-screen prompts. (Quick ACK) Also, you can send an acknowledgement through the MENU system. (Manual ACK)

Quick ACK:

① When an Individual call is received, alarm sounds and the screen below is displayed.

Push [ALARM OFF] to stop the alarm.



② Push [ACK].

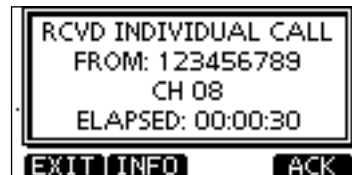

- ③ Select one of three options, then push [ENT].
- Push [EXIT] to return to the normal operating mode.
 - Push [BACK] to return to the previous screen.



- **Able to Comply:** Make an acknowledgment call without any changes.
- **Unable to Comply:** You cannot make a communication. The Acknowledgement call ('Unable to Comply') can be automatically transmitted, if set. See page 65 for details.
- **Propose New Channel:** You can make an acknowledgement call, but you specify the intership channel. Select a desired intership channel, using Dial, or [▲]/[▼], then push [ENT].

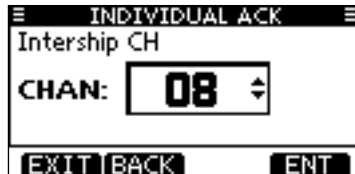

- ④ The Individual ACK confirmation screen is displayed. Push [CALL] to make an acknowledgement call.

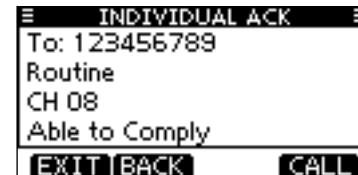

- ⑤ The screens shown below are displayed.

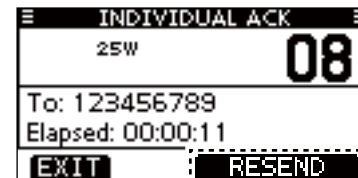
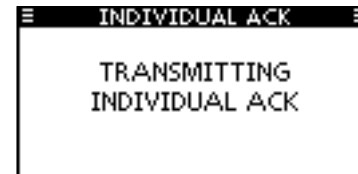

Displayed for only USA version.

- ⑥ Reply to the call using the microphone.
- ⑦ Push [EXIT] to return to the normal operating mode.*
- * Only USA version, the exit confirmation dialog (p. 29) is displayed.
 - Only USA version, push [RESEND] to resend the acknowledgement.

7 DSC OPERATION

■ Making DSC calls

◇ Making an Individual Acknowledgement (continued)

Manual ACK:

- ① Enter "INDIVIDUAL ACK" in the DSC CALLS menu.

◀MENU▶ ⇄ ▶DSC Calls▶ ⇄ ▶Individual ACK▶
(Push [MENU].) (Rotate Dial, then push [ENT].)

- When no Individual call has been received, the Individual ACK item will not be displayed.



- ② Select a desired individual address or ID code to reply to, using Dial or [▲]/[▼], then push [ENT].

- Push [EXIT] to return to the normal operating mode.
- Push [BACK] to return to the previous screen.



- ③ Do steps ③ to ⑦, as described in "Quick ACK:," beginning on the previous page.

◇ Making a Group call

The Group call function allows you to make a DSC signal to only a specific group.

- ① Enter "GROUP CALL" in the DSC CALLS menu.

◀MENU▶ ⇄ ▶DSC Calls▶ ⇄ ▶Group Call▶
(Push [MENU].) (Rotate Dial, then push [ENT].)

- ② Select a desired preset group address or "Manual Input," using Dial or [▲]/[▼], then push Dial or [ENT].

- The ID code for the Group call can be entered first. (p. 23)
- When "Manual Input" is selected, enter the 8 digit ID code for the group you wish to call.
- Push [EXIT] to return to the normal operating mode.
- Push [BACK] to return to the previous screen.

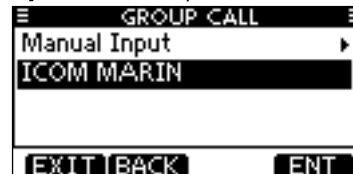

- ③ Select a desired intership channel using Dial or [▲]/[▼], then push [ENT].
 - Intership channels are already preset into the transceiver in the recommended order.



About Manual Entry:

Enter a desired group ID in the following way:

- Select a desired number using Dial, or [◀]/[▶].
- Push [ENT] or Dial to set it.
- To move the cursor, select either arrow, “←” or “→,” then push [ENT] or Dial.
- The first digit is specified as ‘0,’ and the second digit is other than ‘0’ for a Group ID.
- The first two digits are ‘0’ for any Coast station ID.



- ④ A confirmation screen is displayed.
 - Confirm the call contents.



- ⑤ Push [CALL] to make a Group call.
 - If Channel 70 is busy, the transceiver stands by until the channel becomes clear.



- ⑥ After the Group call has been transmitted, the following screen is displayed.



Displayed for only USA version.

- ⑦ Announce the information using the microphone.
- ⑧ After the announcement, push [EXIT] to return to the normal operating mode.*
 - * Only USA version, the exit confirmation dialog (p. 29) is displayed.
 - Only USA version, push [RESEND] to resend the call.

7 DSC OPERATION

■ Making DSC calls (Continued)

◇ Making an All Ships call

All ships that have DSC transceiver use Channel 70 as their 'listening channel.' When you want to announce a message to these ships, use the 'All Ships Call' function.

- ① Enter "ALL SHIPS CALL" in the DSC CALLS menu.

<MENU> ⇄ <DSC Calls> ⇄ <All Ships Call> (Push [MENU].) (Rotate Dial, then push [ENT].)
--

- ② Select a desired category, using Dial or [▲]/[▼], then push Dial or [ENT].

- The selectable category may differ, depending on the presetting. Ask your dealer for the selectable categories.
- Push [EXIT] to return to the normal operating mode.
- Push [BACK] to return to the previous screen.



- ③ Select a desired traffic channel, using Dial or [▲]/[▼], then push Dial or [ENT].

- The selected channel is displayed.



- ④ A confirmation screen is displayed.

- Confirm the call contents.

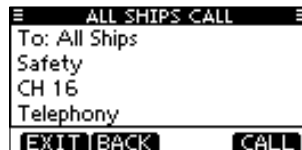

- ⑤ Push [CALL] to make an All Ships call.

- If Channel 70 is busy, the transceiver stands by until the channel becomes clear.



- ⑥ After the All Ships call has been transmitted, the following screen is displayed.

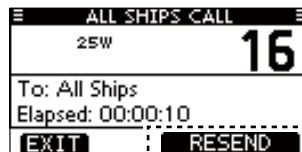

Displayed for only USA version.

- ⑦ Announce the message using the microphone.

- ⑧ After the announcement, push [EXIT] to return to the normal operating mode.*

- * Only USA version, the exit confirmation dialog (p. 29) is displayed.

- Only USA version, push [RESEND] to resend the call.

◇ Making a Position Request Call

(For only USA and Australian version transceivers)

Make a Position Request Call when you want to know a specific ship's current position, and so on.

- 1 Enter "POSITION REQUEST" in the DSC CALLS menu.

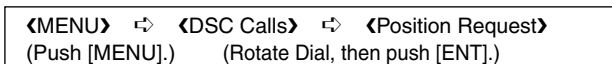

- 2 Select a desired preset individual address, or "Manual Input," using Dial or [▲]/[▼], then push Dial or [ENT].
 - The ID code for the Position Request Call can be entered first. (p. 22)
 - When "Manual Input" is selected, enter a desired 9 digit MMSI ID code for the individual you wish to call.
 - Push [EXIT] to return to the normal operating mode.
 - Push [BACK] to return to the previous screen.

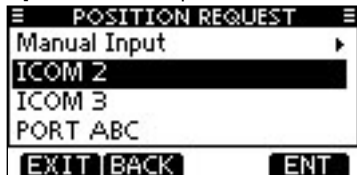

About Manual Entry:

Enter a desired individual ID in the following way:

- Select a desired number using Dial, or [▲]/[▼]/[◀]/[▶].
- Push [ENT] or Dial to set it.
- To move the cursor, select either arrow, "←" or "→," then push [ENT] or Dial.
- The first digit is specified as '0' for a Group ID. If a Group ID is entered, an error beep sounds after pushing [FINISH].
- The first two digits are '0' for any coast station ID.



- 3 A confirmation screen is displayed.
 - Confirm the call contents.



7 DSC OPERATION

■ Making DSC calls

◇ Making a Position Request call (continued)

④ Push [CALL] to make a Position Request Call.

- If Channel 70 is busy, the transceiver stands by until the channel becomes clear.



⑤ After the Position Request Call has been transmitted, the following screen is displayed.

- Push [EXIT] to return to the normal operating mode.*
* Only USA version, the exit confirmation dialog (p. 29) is displayed.
- Only USA version, push [RESEND] to resend the call.



⑥ When the acknowledgement call is received, alarm sounds and the following screen is displayed.



⑦ Push [ALARM OFF] to stop the alarm, and then the screen as shown below is displayed.



⑧ Push [EXIT] to return to the normal operating mode.*

- *Only USA version, the exit confirmation dialog (p. 29) is displayed.

◇ Making a Position Report Call

(For only USA and Australian version transceivers)

Make a Position Report Call when you want to announce your own position to a specific ship and receive an answer back.

- Enter "POSITION REPORT" in the DSC CALLS menu.

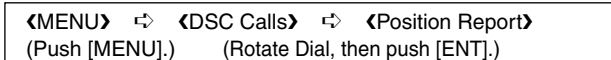

- Select a desired preset individual address, or "Manual Input," using Dial or [▲]/[▼], then push Dial or [ENT].

- The ID code for the Individual call can be entered first. (p. 22)
- When "Manual Input" is selected, enter a desired 9 digit MMSI ID code for the individual you wish to call.
- Push [EXIT] to return to the normal operating mode.
- Push [BACK] to return to the previous screen.

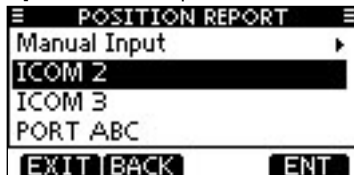

About Manual Entry:

Enter a desired individual ID in the following way:

- Select a desired number using Dial, or [▲]/[▼]/[◀]/[▶].
- Push [ENT] or Dial to set it.
- To move the cursor, select either arrow, "←" or "→," then push [ENT] or Dial.
- The first digit is specified as '0' for a Group ID. If a Group ID is entered, an error beep sounds after pushing [FINISH].
- The first two digits are '0' for any coast station ID.

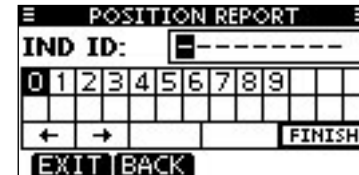

- A confirmation screen is displayed.
 - Confirm the call contents.



7 DSC OPERATION

■ Making DSC calls

◇ Making a Position Report call (continued)

④ Push [CALL] to make a Position Report Call.

- If Channel 70 is busy, the transceiver stands by until the channel becomes clear.



- #### ⑤ After the Position Report Call has been transmitted, the transceiver automatically returns to the normal operating mode.

When no GPS receiver is connected and built-in GPS receiver* is not receiving valid position data, and both position and time have been manually entered, the screen as shown below is displayed. Edit your latitude and longitude position and UTC time as follows:

*For only the IC-M423G, IC-M423GE, and IC-M424G.



- Push [CHG], then edit your latitude and longitude position and UTC time.
 - Select a desired number using Dial, or [▲]/[▼]/[◀]/[▶].
 - Push [ENT] or Dial to set it.
 - To move the cursor, select either arrow, “←” or “→,” then push [ENT] or Dial.
 - Select N (North latitude) or S (South latitude) when the cursor is on the ‘N’ or ‘S’ position.
 - Select W (West longitude) or E (East longitude) when the cursor is on the ‘W’ or ‘E’ position.

◇ Making a Polling Request Call

(For only USA and Australian version transceivers)

Make a Polling Request Call when you want to know a specific vessel is in the communication area, or not.

- Enter "POLLING REQUEST" in the DSC CALLS menu.

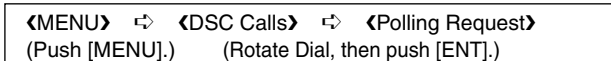

- Select a desired preset individual address, or "Manual Input," using Dial or [▲]/[▼], then push Dial or [ENT].
 - The ID code for the Individual call can be entered first. (p. 22)
 - When "Manual Input" is selected, enter a desired 9 digit MMSI ID code for the individual you wish to call.
 - Push [EXIT] to return to the normal operating mode.
 - Push [BACK] to return to the previous screen.

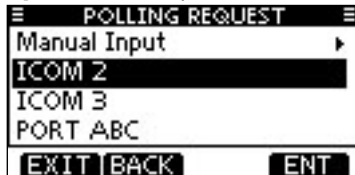

▨ About Manual Entry:

Enter a desired individual ID in the following way:

- Select a desired number using Dial, or [▲]/[▼]/[◀]/[▶].
- Push [ENT] or Dial to set it.
- To move the cursor, select either arrow, "←" or "→," then push [ENT] or Dial.
- The first digit is specified as '0' for a Group ID. If a Group ID is entered, an error beep sounds after pushing [FINISH].
- The first two digits are '0' for any coast station ID.

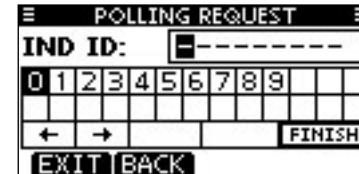

- A confirmation screen is displayed.
 - Confirm the call contents.

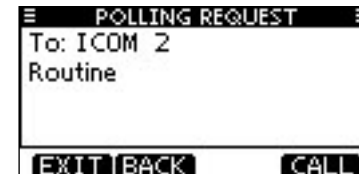

7 DSC OPERATION

■ Making DSC calls

◇ Making a Polling Request call (continued)

④ Push [CALL] to make a Polling Request Call.

- If Channel 70 is busy, the transceiver stands by until the channel becomes clear.

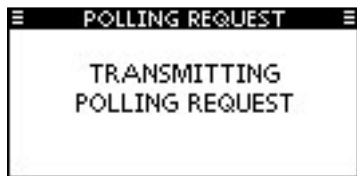

⑤ After the Polling Request Call has been transmitted, the following screen is displayed.

- Push [EXIT] to return to the normal operating mode.*
* Only USA version, the exit confirmation dialog (p. 29) is displayed.
- Only USA version, push [RESEND] to resend the call.

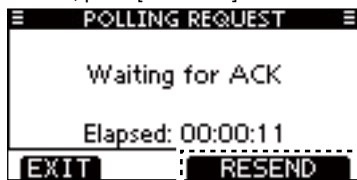

Displayed
for only USA
version.

⑥ When the acknowledgement call is received, alarm sounds and the following screen is displayed.



⑦ Push [ALARM OFF] to stop the alarm, and then the screen as shown below is displayed.

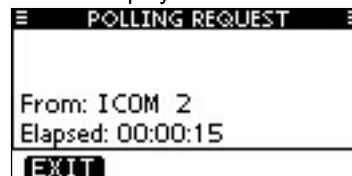

⑧ Push [EXIT] to return to the normal operating mode.*

*Only USA version, the exit confirmation dialog (p. 29) is displayed.

◇ Making a Test call

Testing on the exclusive DSC distress and safety calling channels should be avoided as much as possible. When testing on a distress or safety channel is unavoidable, you should indicate that these are test transmissions.

Normally the test call would require no further communications between the two stations involved.

- 1 Enter "TEST CALL" in the DSC CALLS menu.

◀MENU▶ ⇨ ◀DSC Calls▶ ⇨ ◀Test Call▶
 (Push [MENU].) (Rotate Dial, then push [ENT].)

- 2 Select a desired preset individual address, or "Manual Input," then push Dial or [ENT].
 - The ID code for the Individual call can be entered first. (p. 22)
 - When "Manual Input" is selected, enter the 9 digit MMSI ID code for the individual you wish to call.
 - Push [EXIT] to return to the normal operating mode.
 - Push [BACK] to return to the previous screen.

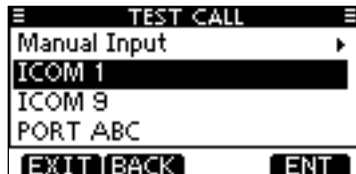

About Manual Entry:

Enter a desired address ID in the following way:

- Select a desired number using Dial, or [◀]/[▶].
- Push [ENT] or Dial to set it.
- To move the cursor, select either arrow, "←" or "→," then push [ENT] or Dial.
- The first digit is specified as '0' for a Group ID. If a 9 digit Group ID is entered, an error beep sounds when pushing [ENT] or dial.
- The first two digits are '0' for any Coast station ID.



- 3 A confirmation screen is displayed.
 - Confirm the call contents.

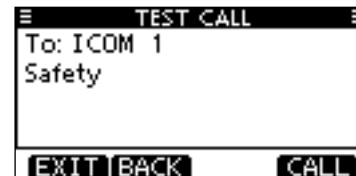

7 DSC OPERATION

■ Making DSC calls

◇ Making a Test call (continued)

④ Push [CALL] to make a Test call.

- If Channel 70 is busy, the transceiver stands by until the channel becomes clear.



⑤ After the Test call has been transmitted, the following screen is displayed.*

- Push [EXIT] to return to the normal operating mode.*
* Only USA version, the exit confirmation dialog (p. 29) is displayed.
- Only USA version, push [RESEND] to resend the call.

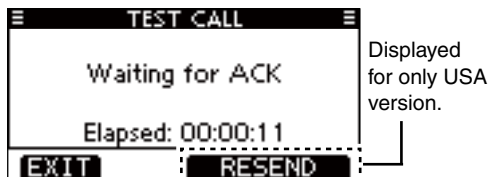

⑥ When the acknowledgement call is received, alarm sounds and the following screen is displayed.



⑦ Push [ALARM OFF] to stop the alarm, and then the screen as shown below is displayed.



⑧ Push [EXIT] to return to the normal operating mode.*

- *Only USA version, the exit confirmation dialog (p. 29) is displayed.

◇ Making a Test Acknowledgement call

When the "TEST ACK" in DSC settings is set to 'Auto TX' (p. 65), the transceiver automatically transmits a reply call when a Test call is received.

Quick ACK:

- ① When a Test call is received, alarm sounds and the screen shown below is displayed.
Push [ALARM OFF] to stop the alarm.



- ② Push [ACK].
 - Push [EXIT] to return to the normal operating mode.
 - Push [INFO] to display the Test call information.

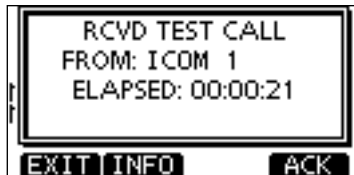

▨ About Received call information:

- Push [EXIT] to return to the normal operating mode.
- Push [BACK] to return to the previous screen.
- Push [ACK] to go to the next step.



- ③ The Test ACK confirmation screen is displayed.
Push [CALL] to make an acknowledgement call.



- ④ While transmitting the acknowledgement call, the screen shown below is displayed, and then returns to the normal operating mode.



7 DSC OPERATION

■ Making DSC calls

◇ Making a Test Acknowledgement call (continued)

Manual ACK:

- ① Enter "TEST ACK" in the DSC CALLS menu.

◀MENU▶ ⇄ ▶DSC Calls▶ ⇄ ▶Test ACK▶
(Push [MENU].) (Rotate Dial, then push [ENT].)

- If no Test call has been received, the "TEST ACK" item will not be displayed.
- Push [EXIT] to return to the normal operating mode.
- Push [BACK] to return to the previous screen.

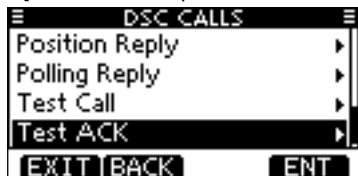

- ② Select a desired Test call to reply to, using Dial or [▲]/[▼], then push Dial or [ENT].



- ③ The Test ACK confirmation screen is displayed. Push [CALL] to make an acknowledgement call.



- ④ While transmitting the acknowledgement call, the screen shown below is displayed, and then returns to the normal operating mode.



◇ Making a Position Reply call

Make a Position Reply call when a Position Request call is received.

When the “POSITION ACK” in DSC Settings is set to ‘Auto TX’ (p. 65), the transceiver automatically transmits a reply call when a Position Request call is received.

Quick Reply:

- ① When a Position Request call is received, alarm sounds and the screen shown below is displayed.
Push [ALARM OFF] to stop the alarm.



- ② Push [ACK].
 - Push [EXIT] to return to the normal operating mode.
 - Push [INFO] to display the Test call information.



/// About Received call information:

- Push [EXIT] to return to the normal operating mode.
- Push [BACK] to return to the previous screen.
- Push [ACK] to go to the next step.



- ③ The Position Reply confirmation screen is displayed.
Push [CALL] to make a reply call.



- ④ While transmitting the reply call, the screen shown below is displayed, and then returns to the normal operating mode.



7 DSC OPERATION

■ Making DSC calls

◇ Making a Position Reply call (continued)

Manual Reply:

① Enter "POSITION REPLY" in the DSC CALLS menu.

◀MENU▶ ⇔ ▶DSC Calls▶ ⇔ ▶Position Reply▶
(Push [MENU].) (Rotate Dial, then push [ENT].)

- If no Position Request call is received, the Position Reply item will not be displayed.
- Push [EXIT] to return to the normal operating mode.
- Push [BACK] to return to the previous screen.



② Select a desired Position Request call to reply to, using Dial or [▲]/[▼], then push Dial or [ENT].



③ The Position Reply call confirmation screen is displayed. Push [CALL] to make an acknowledgement call.



④ While transmitting the reply call, the screen shown below is displayed, and then returns to the normal operating mode.



When no GPS receiver is connected and built-in GPS receiver* is not receiving valid position data, and both position and time have been manually entered, the screen as shown below is displayed. Edit your latitude and longitude position and UTC time as follows:

*For only the IC-M423G, IC-M423GE, and IC-M424G.



- Push [CHG], then edit your latitude and longitude position and UTC time.
 - Select a desired number using Dial, or [▲]/[▼]/[◀]/[▶].
 - Push [ENT] or Dial to set it.
 - To move the cursor, select either arrow, "←" or "→," then push [ENT] or Dial.
 - Select N (North latitude) or S (South latitude) when the cursor is on the 'N' or 'S' position.
 - Select W (West longitude) or E (East longitude) when the cursor is on the 'W' or 'E' position.

◇ Making a Position Report Reply call

Make a Position Report Reply call when a Position Report call is received.

Quick Reply:

- ① When a Position Report call is received, alarm sounds and the screen as shown below is displayed.
Push [ALARM OFF] to stop the alarm.



- ② Push [ACK].
 - Push [EXIT] to return to the normal operating mode.
 - Push [INFO] to display the Position Report Request call information.



/// About Received call information:

- Push [EXIT] to return to the normal operating mode.
- Push [BACK] to return to the previous screen.
- Push [ACK] to go to the next step.

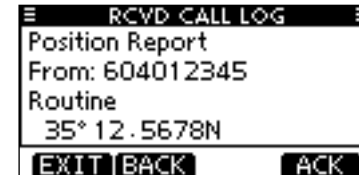

- ③ The Position Report Reply confirmation screen is displayed.
Push [CALL] to make a reply call.

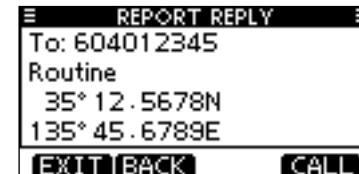

- ④ While transmitting the reply call, the screen shown below is displayed, and then returns to the normal operating mode.



7 DSC OPERATION

■ Making DSC calls

◇ Making a Position Report Reply call (continued)

Manual Reply:

① Enter "REPORT REPLY" in the DSC CALLS menu.

◀MENU▶ ⇄ ▶DSC Calls▶ ⇄ ▶Position Report Reply▶
(Push [MENU].) (Rotate Dial, then push [ENT].)

- If no Position Report Request call is received, the Position Report Reply item will not be displayed.
- Push [EXIT] to return to the normal operating mode.
- Push [BACK] to return to the previous screen.



② Select a desired Position Report Request call to reply to, using Dial or [▲]/[▼], then push Dial or [ENT].



③ The Position Report Reply call confirmation screen is displayed.

Push [CALL] to make an acknowledgement call.



④ While transmitting the reply call, the screen shown below is displayed, and then returns to the normal operating mode.



◇ Making a Polling Request Reply call

Make a Polling Request Reply call when a Polling Request call is received.

When the “POSITION ACK” in DSC Settings is set to ‘Auto TX’ (p. 65), the transceiver automatically transmits a reply call when receiving a Polling Request call.

Quick Reply:

- ① When a Polling Request call is received, alarm sounds and the screen as shown below is displayed.
Push [ALARM OFF] to stop the alarm.

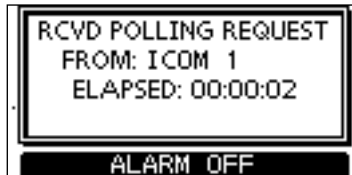

- ② Push [ACK].
 - Push [EXIT] to return to the normal operating mode.
 - Push [INFO] to display the Polling Request call information.

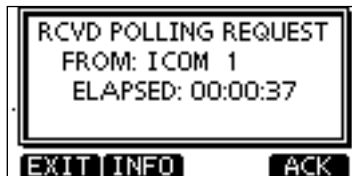

▨ About Received call information:

- Push [EXIT] to return to the normal operating mode.
- Push [BACK] to return to the previous screen.
- Push [ACK] to go to the next step.



- ③ The Polling Request Reply confirmation screen is displayed.
Push [CALL] to make a reply call.

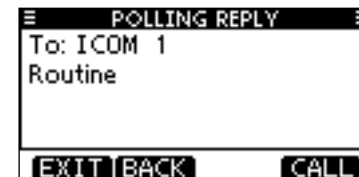

- ④ While transmitting the reply call, the screen shown below is displayed, and then returns to the normal operating mode.



7 DSC OPERATION

■ Making DSC calls

◇ Making a Polling Request Reply call (continued)

Manual Reply:

- ① Enter "POLLING REPLY" in the DSC CALLS menu.

◀MENU▶ ⇄ ▶DSC Calls▶ ⇄ ▶Polling Reply▶
(Push [MENU].) (Rotate Dial, then push [ENT].)

- If no Polling Request call is received, the Polling Reply item will not be displayed.
- Push [EXIT] to return to the normal operating mode.
- Push [BACK] to return to the previous screen.

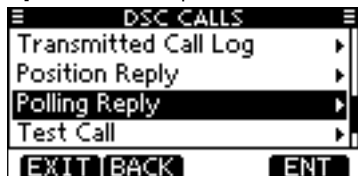

- ② Select a desired Polling Request call to be replied, using Dial or [▲]/[▼], then push Dial or [ENT].

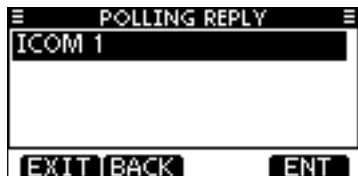

- ③ The Polling Request Reply call confirmation screen is displayed. Push [CALL] to make an acknowledgement call.

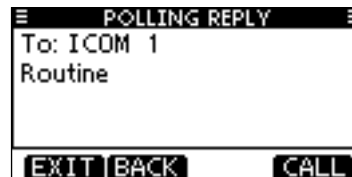

- ④ While transmitting the reply call, the screen shown below is displayed, and then returns to the normal operating mode.



■ Receiving DSC calls

◇ Receiving a Distress Call/Distress Acknowledgement

[Example]: Receiving a Distress Call.

When a Distress Call is received:

- ➔ The emergency alarm sounds for 2 minutes.
- ➔ “RCVD DISTRESS” is displayed and the backlight blinks.

- ① Push [ALARM OFF] to stop the alarm and the blinking backlight.
 - Even if you do not push [ALARM OFF], the alarm stops after 2 minutes, and then the screen in step ② is displayed.



- ② Push a softkey to select your desired action.



[IGN]

- ➔ Push to return to the normal operating mode.
 - The transceiver exits the DSC mode.
 - By pushing [PTT], the transceiver also exits the DSC mode.
 - “” continues to blink and the Call is stored in the Received Call Log.

[INFO]

- ➔ Push to display the Received call information. (p. 63)

[PAUSE] (For only USA version transceivers)

- ➔ Push to pause the countdown.
 - The softkey is displayed if the “CH Auto Switch:” item in the DSC SET menu (p. 66) is set to “10 sec.”
 - Push [RESUME] to resume the countdown.
 - The call is saved in the received call log.

[ACPT]

- ➔ Push to accept the call.

And then, push [CH 16] to change the operating channel to Channel 16, and then monitor it, as a coast station may require assistance.

 - Even if you haven’t pushed [CH 16] within 10 seconds, the operating channel automatically changes to Channel 16. (p. 66)

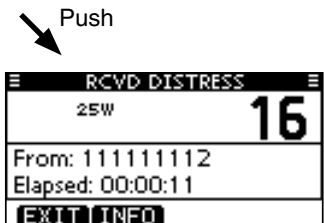
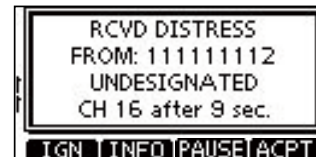

7 DSC OPERATION

■ Receiving DSC calls (Continued)

◇ Receiving a Distress Relay Call/Distress Relay Acknowledgement

[Example]: Receiving a Distress Relay call.

When a Distress Relay call is received:

- ➔ The emergency alarm sounds for 2 minutes.
- ➔ "RCVD DISTRESS RELAY" is displayed and the backlight blinks.

① Push [ALARM OFF] to stop the alarm and the blinking backlight.

- Even if you do not push [ALARM OFF], the alarm stops after 2 minutes, and then the screen in step ② is displayed.



② Push a softkey to select your desired action.



[IGN]

- ➔ Push to return to the normal operating mode.
 - The transceiver exits the DSC mode.
 - By pushing [PTT], the transceiver also exits the DSC mode.
 - "📞" continues to blink and the Call is stored in the Received Call Log.

[INFO]

- ➔ Push to display the Received call information. (p. 63)

[PAUSE] (For only USA version transceivers)

- ➔ Push to pause the countdown.
 - The softkey is displayed if the "CH Auto Switch:" item in the DSC SET menu (p. 66) is set to "10 sec."
 - Push [RESUME] to resume the countdown.
 - The call is saved in the received call log.

[ACPT]

- ➔ Push to accept the call.

And then, push [CH 16] to change the operating channel to Channel 16, and then monitor it, as a coast station may require assistance.

 - Even if you haven't pushed [CH 16] within 10 seconds, the operating channel automatically changes to Channel 16. (p. 66)
 - Push [EXIT] to return to the normal operating mode.*

*Only USA version, the exit confirmation dialog (p. 29) is displayed.

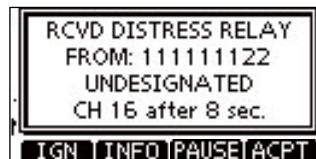

➔ Push

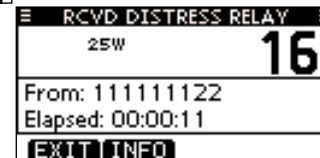

◇ Receiving an Individual Call

When an Individual Call is received:

- The alarm sounds for 2 minutes.
- “RCVD INDIVIDUAL CALL” is displayed. The backlight may blink for 2 minutes, depending on the received Category.

- ① Push [ALARM OFF] to stop the alarm and the blinking backlight.
 - Even if you do not push [ALARM OFF], the alarm stops after 2 minutes, and then the screen in step ② is displayed.



- ② Push a softkey to select your desired action.



[IGN]

- Push to ignore the Call and return to the normal operating mode.
 - The transceiver exits the DSC mode.
 - “” continues to blink and the Call is stored in the Received Call Log.

[INFO]

- Push to display the Received call information. (p. 63)

[PAUSE] (For only USA version transceivers)

- Push to pause the countdown.
 - The softkey is displayed if the “CH Auto Switch:” item in the DSC SET menu (p. 66) is set to “10 sec.”
 - Push [RESUME] to resume the countdown.
 - The call is saved in the received call log.

[ACK]

- Push to display the “INDIVIDUAL ACK” screen to reply to the Call. Select one of three options, depending on your situation. See page 34 for details of the Individual Acknowledgement procedures.
 - Push [EXIT] to return to the normal operating mode.*
- *Only USA version, the exit confirmation dialog (p. 29) is displayed.

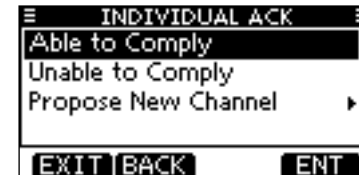

- ▨ When “INDIVIDUAL ACK” is set to “Auto TX (Unable),” the transceiver automatically replies to the Call. In that case, both the TX and RX calls are stored in the Transmitted and Received Call Logs.

7 DSC OPERATION

■ Receiving DSC calls (Continued)

◇ Receiving a Group Call/Geographical Area Call/All Ships Call

When a Group Call, Geographical Area Call, or All Ships Call is received:

- ➔ The alarm sounds for 2 minutes.
- ➔ “RCVD GROUP CALL,” “RCVD GEOGRAPHICAL,” or “RCVD ALL SHIPS CALL” is displayed. The backlight may blink for 2 minutes, depending on the received Category.

① Push [ALARM OFF] to stop the alarm and the blinking backlight.

- Even if you do not push [ALARM OFF], the alarm stops after 2 minutes, and then the screen in step ② is displayed.



② Push a softkey to select your desired action.



[IGN]

- ➔ Push to ignore the Call and return to the normal operating mode.
 - The transceiver exits the DSC mode.
 - “✉” continues to blink and the Call is stored in the Received Call Log.

[INFO]

- ➔ Push to display the Received call information. (p. 63)

[PAUSE] (For only USA version transceivers)

- ➔ Push to pause the countdown.
 - The softkey is displayed if the “CH Auto Switch:” item in the DSC SET menu (p. 66) is set to “10 sec.”
 - Push [RESUME] to resume the countdown.
 - The call is saved in the received call log.

[ACPT]

- ➔ Push to monitor the channel specified by the calling station for an announcement from the calling station.
 - Push [EXIT] to return to the normal operating mode.*
- *Only USA version, the exit confirmation dialog (p. 29) is displayed.

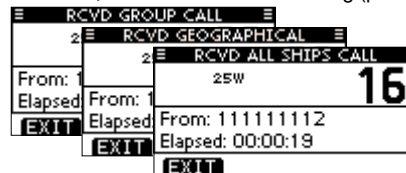

/// Note for Geographical Area Call

When no GPS receiver is connected or if there is a problem with the external receiver, all Geographical Area Calls are received, regardless of your position.

◇ Receiving a Position Request Call

When a Position Request Call is received:

- ➔ The alarm sounds for 2 minutes.
- ➔ “RCVD POS REQUEST” is displayed. The backlight blinks for 2 minutes.

① Push [ALARM OFF] to stop the alarm and the blinking backlight.

- Even if you do not push [ALARM OFF], the alarm stops after 2 minutes, and then the screen in step ② is displayed.



② Push a softkey to select your desired action.



USA version

[IGN]

- ➔ Push to ignore the Call and return to the normal operating mode.
 - The transceiver exits the DSC mode.
 - “☑” continues to blink and the Call is stored in the Received Call Log.

[INFO]

- ➔ Push to display the Received call information. (p. 63)

[UNABLE] (For only USA version transceivers)

- ➔ Push to transmit the “Unable to Comply” acknowledgement.
 - The call is saved in the DSC Log.

[ABLE] (For only USA version transceivers)

- ➔ Push to transmit the “Able to Comply” acknowledgement.
 - The call is saved in the DSC Log.

[ACK]

- ➔ Push to display the “POSITION REPLY” screen and send a reply to the Call. (p. 49)



- /// When “POSITION ACK” is set to “Auto TX,” the transceiver automatically replies to the Call. In that case, both the TX and RX calls are stored in the Transmitted and Received Call Logs.

7 DSC OPERATION

■ Receiving DSC calls (Continued)

◇ Receiving a Position Report Call

When a Position Report Call is received:

- The alarm sounds for 2 minutes.
- “RCVD POSITION REPORT” is displayed. The backlight blinks for 2 minutes.

① Push [ALARM OFF] to stop the alarm and the blinking backlight.

- Even if you do not push [ALARM OFF], the alarm stops after 2 minutes, and then the screen in step ② is displayed.



② Push a softkey to select your desired action.

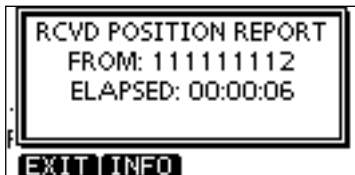

[EXIT]

- Push to ignore the Call and return to the normal operating mode.
 - The transceiver exits the DSC mode.
 - “✉” continues to blink and the Call is stored in the Received Call Log.

[INFO]

- Push to display the Received call information. (p. 63)

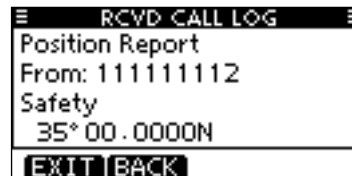

◇ **Receiving a Polling Request call/Test Call**

[Example]: Receiving a Polling Request call.

When a Polling Request call is received:

- The alarm sounds for 2 minutes.
- “RCVD POLLING REQUEST” is displayed. The backlight blinks for 2 minutes.

- ① Push [ALARM OFF] to stop the alarm and the blinking backlight.
 - Even if you do not push [ALARM OFF], the alarm stops after 2 minutes, and then the screen in step ② is displayed.

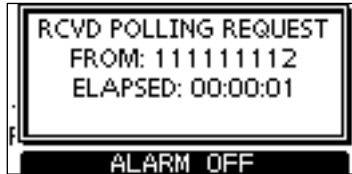

- ② Push a softkey to select your desired action.



[IGN]

- Push to ignore the Call and return to the normal operating mode.
 - The transceiver exits the DSC mode.
 - “☑” continues to blink and the Call is stored in the Received Call Log.

[INFO]

- Push to display the Received call information. (p. 63)

[ACK]

- Push to display the “POLLING REPLY” screen to reply to the Call. (p. 53)

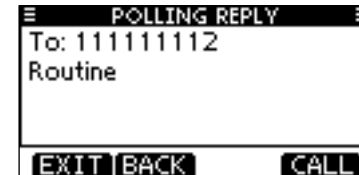

When “POSITION ACK” or “TEST ACK” is set to “Auto TX,” the transceiver automatically replies to the Call. In that case, both the TX and RX calls are stored in the Transmitted and Received Call Logs.

7 DSC OPERATION

■ Receiving DSC calls (Continued)

◇ Receiving a Test Acknowledgement Call

When a Test Acknowledgement Call is received:

- The alarm sounds for 2 minutes.
- “RCVD TEST ACK” is displayed. The backlight blinks for 2 minutes.

- ① Push [ALARM OFF] to stop the alarm and the blinking backlight.
 - Even if you do not push [ALARM OFF], the alarm stops after 2 minutes, and then the screen in step ② is displayed.



- ② Push a softkey to select your desired action.

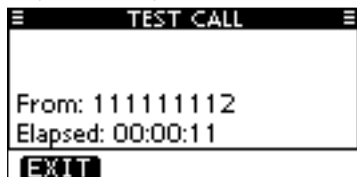

[EXIT]

- Push to return to the normal operating mode.
 - The transceiver exits the DSC mode.
 - “” continues to blink and the Call is stored in the Received Call Log.

■ Transmitted Call log

The transceiver automatically stores up to 50 transmitted calls, and the logs can be used as a supplement to your log-book.

- ① Enter “TX CALL LOG” in the DSC CALLS menu.

◀[MENU]▶ ⇄ ◀DSC Calls▶ ⇄ ◀Transmitted Call Log▶
(Push [MENU].) (Rotate Dial, then push [ENT].)

- ② Push [▲]/[▼] to select the desired item, then push [ENT].
 - Push [BACK] to return to the previous screen.
 - Push [EXIT] to return to the normal operating mode.



- ③ Rotate Dial to scroll the DSC message contents.

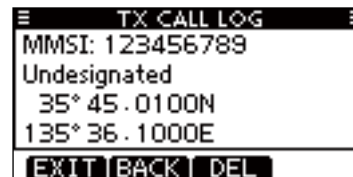

Rotate



- ④ To delete the displayed DSC message, push [DEL].
 - The confirmation screen is displayed, then push [OK] to delete.
- ⑤ Push [EXIT] to return to the normal operating mode.

■ Received Call log

The transceiver automatically stores up to 50 distress messages and 50 other messages, and they can be used as a supplement to your logbook.

- While in the normal operating mode, “✉” blinks in the upper right corner of the LCD when there is an unread DSC message.

◇ Distress message

- ① Push [LOG] to enter “RCVD CALL LOG” in the DSC CALLS menu, or you can enter it through the Menu screen.

◀[MENU] ⇨ ▶[DSC Calls] ⇨ ▶[Received Call Log]
(Push [MENU].) (Rotate Dial, then push [ENT].)

- ② Push [▲]/[▼] to select “Distress,” then push [ENT].
 - The Distress messages are stored in “Distress.”
 - “✉” is displayed when there are unread DSC messages.
 - “🏠” is displayed when there are no unread DSC messages.
 - No icon is displayed when there are no DSC messages.
 - Push [BACK] to return to the previous screen.
 - Push [EXIT] to return to the normal operating mode.



- ③ Push [▲]/[▼] to select the desired item, then push [ENT].

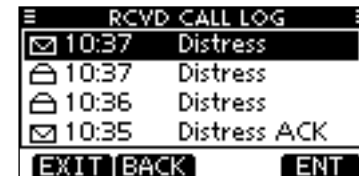

- ④ Rotate Dial to scroll the DSC message contents.



- ⑤ To delete the displayed DSC message, push [DEL].
 - The confirmation screen is displayed, then push [OK] to delete.
- ⑥ Push [EXIT] to return to the normal operating mode.

7 DSC OPERATION

■ Received Call log (Continued)

◇ Other messages

- ① Push [LOG] to enter “RCVD CALL LOG” in the DSC CALLS menu, or you can enter it through the Menu screen.

◀MENU▶ ⇄ ◀DSC Calls▶ ⇄ ◀Received Call Log▶
(Push [MENU].) (Rotate Dial, then push [ENT].)

- ② Push [▲]/[▼] to select “Others,” then push [ENT].
- The messages other than the Distress are stored in “Others.”
 - “✉” is displayed when there are unread DSC messages.
 - “☑” is displayed when there are no unread DSC messages.
 - No icon is displayed when there are no DSC messages.
 - Push [BACK] to return to the previous screen.
 - Push [EXIT] to return to the normal operating mode.

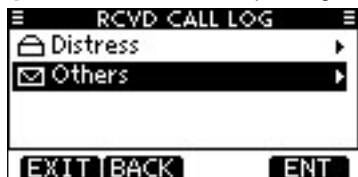

- ③ Push [▲]/[▼] to select the desired item, then push [ENT].
- The message in the unopened file has not been read.

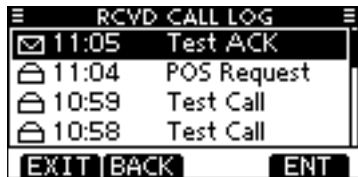

- ④ Rotate Dial to scroll the DSC message contents.
- The stored message has various information, depending on the DSC call type.



- ⑤ To delete the displayed DSC message, push [DEL].
- The confirmation screen is displayed, then push [OK] to delete.
- ⑥ Push [EXIT] to return to the normal operating mode.

■ DSC Settings

- ◇ Position Entry (See page 25)
- ◇ Add Individual ID/Group ID (See pages 22, 23)
- ◇ Delete Individual ID/Group ID (See page 24)

◇ Automatic Acknowledgement

These items set the Automatic Acknowledgement function to “Auto TX” or “Manual TX.”

When an Individual, Position Request, Polling Request, or Test Call is received, the transceiver automatically transmits an Individual Acknowledgement, Position Reply, Polling Reply or Test Acknowledgement Call, respectively.

When “INDIVIDUAL ACK” is set to “Auto TX,” the transceiver automatically transmits the Acknowledgment call including “Unable to Comply” (No Reason Given) after receiving the Individual call.

- ① Enter either “INDIVIDUAL ACK,” “POSITION ACK” or “TEST ACK” in the DSC Settings menu.

◀MENU▶ ⇄ ▶DSC Settings▶ ⇄ ▶Individual ACK▶
(Push [MENU].) (Rotate Dial, then push [ENT].)

◀MENU▶ ⇄ ▶DSC Settings▶ ⇄ ▶Position ACK▶

◀MENU▶ ⇄ ▶DSC Settings▶ ⇄ ▶Test ACK▶

- ② Rotate Dial to select “Auto TX” or “Manual TX,” then push [ENT].
 - Push [BACK] to cancel and return to the DSC Settings menu.

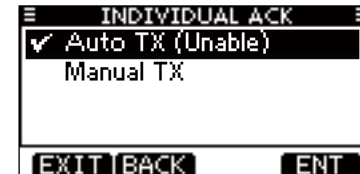

(default)

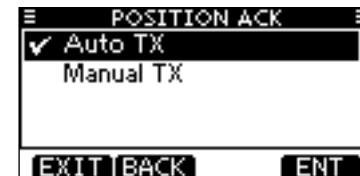

(default)

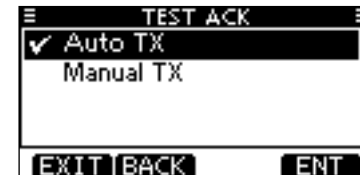

(default)

- ③ Push [EXIT] to return to the normal operating mode.

7 DSC OPERATION

■ DSC Settings (Continued)

◇ Channel Auto Switch function/Channel 16 Switch function

Channel Auto Switch Function:

(For only USA version transceivers)

By regulation, after receiving a DSC call, the transceiver changes the operating channel to the channel assigned by the received DSC call. However, when this setting is set to "OFF," the function enables the transceiver to remain on the operating channel, even after receiving a Distress call.

- ① Enter "CH AUTO SWITCH" in the DSC Settings menu.

◀MENU▶	↔	◀DSC Settings▶	↔	◀CH Auto Switch▶
(Push [MENU].)		(Rotate Dial, then push [ENT].)		

- ② Rotate Dial or push [▲]/[▼] to set the Channel Auto Switch function to "Auto (No Delay)," "10 Second Delay," or "OFF," then push [ENT].
 - Push [BACK] to return to the previous screen.

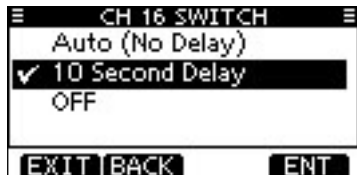

(default)

Auto (No Delay): After receiving a DSC call, and [ACPT] is pushed on the confirmation screen, the transceiver immediately changes to the channel assigned by the received DSC call.

10 Second Delay: After receiving a Distress call, and [ACPT] is pushed on the confirmation screen, the transceiver remains on the current operating channel for 10 seconds. After that, the transceiver automatically changes to the channel assigned by the received DSC call. (default)

OFF: Even after receiving a Distress call, the transceiver remains on the operating channel.

- "⚠" is displayed.

- ③ Push [EXIT] to return to the normal operating mode.

Channel 16 Switch Function:

For transceivers other than USA versions, the Channel Auto switch function is applies to only Distress calls. The transceiver changes the operating channel to Channel 16 after receiving a Distress call.

◇ Alarm

Set the Alarm function ON or OFF, depending on the Category or Status.

- ① Enter "ALARM" in the DSC Settings menu.

◀MENU ▶ ⇨ ▶DSC Settings▶ ⇨ ▶Alarm▶
(Push [MENU].) (Rotate Dial, then push [ENT].)

- ② Rotate Dial or push [▲]/[▼] to select the status, then push [ENT].

- Push [BACK] to return to the previous screen.
- "Safety," "Routine," "Warning," "Self-Terminate" and "Discrete" are selectable. (default: ON)

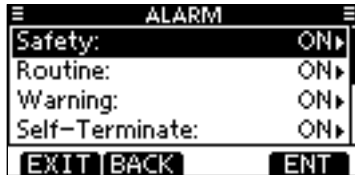

- ③ Rotate Dial or push [▲]/[▼] to set the Alarm setting to "ON" or "OFF."
- ④ Push [EXIT] to return to the normal operating mode.

◇ Channel 70 Squelch level

Set the squelch level on Channel 70.

The transceiver has 11 squelch levels between 1 (loose squelch) and 10 (tight squelch) and OPEN. OPEN is completely open.

OPEN is completely open.

- ① Enter "CH 70 SQL LEVEL" in the DSC Settings menu.

◀MENU ▶ ⇨ ▶DSC Settings▶ ⇨ ▶CH 70 SQL Level▶
(Push [MENU].) (Rotate Dial, then push [ENT].)

- ② Rotate Dial or push [▲]/[▼] to adjust the squelch level until the noise just disappears, then push [ENT].

- Push [BACK] to cancel and return to the DSC Settings menu.

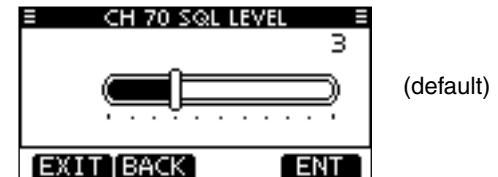

- ③ Push [EXIT] to return to the normal operating mode.

7 DSC OPERATION

■ DSC Settings (Continued)

◇ DSC Loop Test

The DSC loop test function sends transmit DSC signals to the receive AF circuit to compare and check the TX and RX signals at the AF level.

- ① Enter "DSC LOOP TEST" in the DSC Settings menu.

◀MENU▶	↔	◀DSC Settings▶	↔	◀DSC Loop Test▶
(Push [MENU].)		(Rotate Dial, then push [ENT].)		

- ② Push [ENT] to start the DSC loop test.
 - Push [BACK] to return to the previous screen.



- When the transmit DSC and receive DSC signals match, "OK" is displayed.
- ③ Push [EXIT] to return to the normal operating mode.

/// If "NG" is displayed in step ②, either or both TX and RX DSC circuits has a problem. In that case, you will have to send the transceiver to your nearest dealer for repair.

■ Making an Individual call using an AIS transponder

When the optional MA-500TR/MA-510TR* CLASS B AIS TRANSPONDER is connected to your transceiver, an individual DSC call can be transmitted to a selected AIS target, without needing to enter the target's MMSI code. In this case, the call type is automatically set to Routine.

See page 85 for connecting instructions.

* Unreleased as of April 2020.

/// To ensure correct operation of the DSC function, make sure you correctly set the CH70 SQL LEVEL. (p. 67)

Step 1: Transponder's operation

/// **NOTE:** This instruction is for the MA-500TR. See the MA-510TR Instruction manual for the MA-510TR's step.

- ① Select a desired AIS target on the plotter, target list or danger list display.
 - You can also go to the next step whenever the detail screen of the AIS target is displayed.
 - Make sure the transceiver is in the normal operating mode. Otherwise, you cannot make an individual DSC call using the transponder.
- ② Push [DSC] to display the voice channel selection screen, and then push [▲] or [▼] to select a desired voice channel*.
 - Voice channels are already preset into the transponder in recommended order.

*When a coast station is selected in step ①, a voice channel will be specified by the coast station, therefore you cannot change the channel. The transponder will display "Voice Channel is specified by the Base station," in this case.



Transponder's display

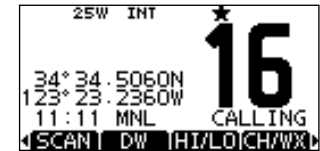

Transceiver's display

- ③ Push [DSC] to make an individual DSC call to the AIS target.
 - If Channel 70 is busy, the transceiver stands by until the channel becomes clear.
 - If the transceiver cannot make the call, the transponder will display "DSC Transmission FAILED."

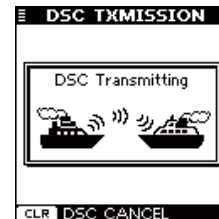

Transponder's display

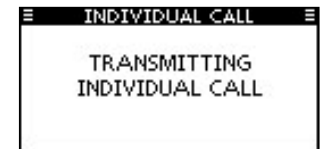

Transceiver's display

7 DSC OPERATION

■ Making an Individual call using an AIS transponder (Continued)

④ After making the individual DSC call, the transponder will display “DSC Transmission COMPLETED.”

- Push [CLEAR] to return to the screen displayed before you entered the voice channel selection screen in step ②.
- The transceiver stands by on Channel 70 until an acknowledgement is received.



Transponder's display

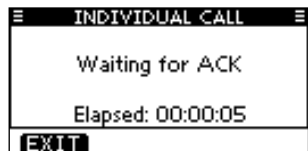

Transceiver's display

Step 2: Transceiver's operation

⑤ When the acknowledgement is received, alarm sounds.

- ➔ If the acknowledgement 'Able to comply' is received, push [ALARM OFF] to stop the alarm, and then select the intership channel specified in step ②.
 - A different intership channel will be selected if the station you called cannot use the channel.
 - To reply, push [PTT] and speak at your normal voice level.
 - You can check the MMSI code or the name, if entered, of the AIS target on the display.
- ➔ If the acknowledgement 'Unable to comply' is received, push [ALARM OFF] to stop the alarm, and then “INDIVIDUAL CALL FAILED” is displayed.

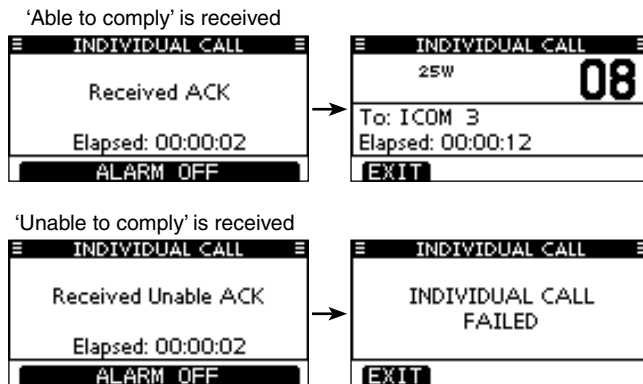

⑥ After the communication is finished, push [EXIT] to return to the normal operating mode.

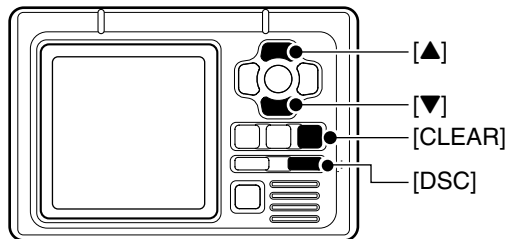

TRANSPONDER

■ Using the Intercom

The optional Intercom function allows you to talk between the transceiver and the where the Command microphone is located. The optional HM-195 COMMAND MICROPHONE is required for Intercom operation.

Connect the HM-195 COMMAND MICROPHONE as described on page 89.

While using the intercom:

- Transmitting is disabled.
- Received audio is muted.

- ① Hold down [PWR](Dial) to turn ON the power.
 - The command microphone power is automatically turned ON, even if the mic power is OFF.
- ② Push [INCM] to enter the Intercom mode.

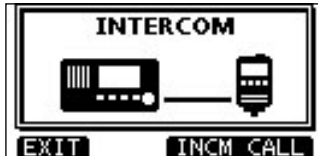

- ③ Hold down [INCM CALL] to sound the intercom beeps.
 - The transceiver and the command microphone sound beeps while holding down [INCM CALL].
 - "CALL" is displayed.



- ④ After releasing [INCM CALL], hold down [PTT] and speak into the microphone at your normal voice level.
 - "TALK" is displayed on the caller's display, and "LSTN" is displayed on the listener's display.
 - Rotate dial to adjust the transceiver's intercom volume level.
 - Rotate [VOL/SQL](Dial) on the HM-195 to adjust the HM-195's intercom volume level, .
- ⑤ After releasing [PTT], you can hear the response through the speaker.



On the caller's display



On the listener's display

- ⑥ Push [EXIT] to return to the normal operating mode.

While in the Intercom mode, the transmit and receive functions are disabled. When the transceiver is transmitting, the Intercom function is disabled.

8 OTHER FUNCTIONS

■ Using the RX Speaker

The RX Speaker function enables you to hear the received audio through a PA speaker.

Connect a PA speaker as described on page 84.

- ① Push [RX] to enter the RX Speaker mode.
 - The RX Speaker volume level adjustment screen is displayed.



- ② Rotate Dial or push [▲]/[▼]/[◀]/[▶] to adjust the RX Speaker volume level, and then push [ENT].
 - “RX” is displayed.



- ③ Push [RX] to return to the normal operating mode.
 - “RX” disappears.

▨ To adjust the audio output level in the RX Speaker mode, hold down [RX] for 1 second to display the RX Speaker volume level adjustment screen, and then rotate Dial. After adjusting, push [ENT] to set it.

■ Using the PA (Public Address)

The transceiver has a PA function to make announcements through a PA speaker.

Connect a PA speaker rated at more than 10 W at 10% distortion with a 4 Ω load, as described on page 84.

- Transmitting is disabled while in the PA mode.

- ① Push [PA] to enter the Public Address mode.



- ② Hold down [PTT] and speak at your normal voice level.
 - While holding down [PTT], the screen below is displayed.
 - Rotate Dial or push [▲]/[▼]/[◀]/[▶] to adjust the PA volume level.



- ③ Push [EXIT] to return to normal operating screen.

▨ While in the PA mode, the transmit and receive functions are disabled. When the transceiver is transmitting, the PA function is disabled.

■ Using the Horn

The Horn function sounds a horn.

Connect a PA speaker as described on page 84.

- ① Push [HORN] to enter the Horn mode.



- ② Hold down [HORN] to sound a horn.
 - While holding down [HORN], the horn sounds, and the screen below is displayed.
 - Rotate Dial or push [▲]/[▼]/[◀]/[▶] to adjust the horn volume level.



- ③ Push [EXIT] to return to the normal operating screen.

/// While in the Horn mode, the transmit and receive functions are disabled. When the transceiver is transmitting, the Horn function is disabled.

■ Using the Menu screen

The Menu screen is used for entering infrequently changed values, function settings or making DSC calls.

In addition to this page, see pages 75 through 83 for details.



Menu lists

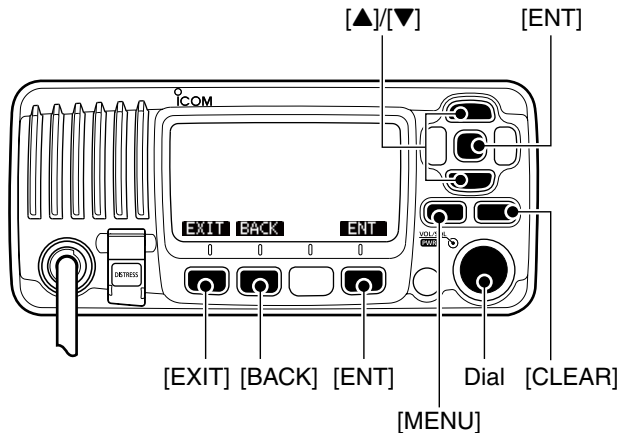

◇ Entering the Menu screen

Example: Set the channel/group to “USA”

- ① Push [MENU].



- ② Rotate Dial or push [▲]/[▼] to select the root item (Radio Settings), and then push [ENT].



- If [▲] or [▼] is continuously held down, the items are sequentially highlighted.

- ③ Rotate Dial or push [▲]/[▼] to select “CHAN Group,” and then push [ENT].



- ④ Rotate Dial or push [▲]/[▼] to select “USA,” and then push [ENT] to set it.
- “✓” is displayed next to “USA.”

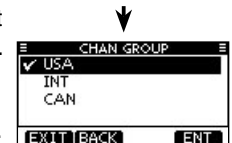

- ⑤ Push [EXIT] to exit the Menu screen.
- Push [CLEAR] or [BACK] to return to the previous screen.

■ Menu screen items

The Menu screen contains the following items.

◇ DSC Calls

Item	Ref.	Item	Ref.
• Individual Call	p. 32	• Transmitted Call Log	p. 62
• Individual ACK*1	p. 34	• Position Request*2	p. 39
• Group Call	p. 36	• Position Report*2	p. 41
• All Ships Call	p. 38	• Polling Request*2	p. 43
• Distress Call	p. 26	• Test Call	p. 45
• Distress Relay ACK*5	p. 30	• Test ACK*1	p. 47
• Received Call Log	p. 63		

◇ DSC Settings

Item	Ref.	Item	Ref.
• Position Input*3	p. 25	• Test ACK	p. 65
• Individual ID	p. 22	• CH 16 Switch	p. 66
• Group ID	p. 23	• Alarm	p. 67
• Individual ACK	p. 65	• CH 70 SQL Level	p. 67
• Position ACK	p. 65	• DSC Loop Test	p. 68

- *1 Displayed only after receiving a corresponding call.
- *2 For only USA and Australian version transceivers.
- *3 Displayed only when no GPS information is received.
- *4 Displayed only when the optional HM-195 is connected.
- *5 For only USA version transceivers.
- *6 This setting may not be usable, depending on the transceiver version or presetting.

◇ Radio Settings

Item	Ref.	Item	Ref.
• Scan Type	p. 76	• WX Alert*2	p. 77
• Scan Timer	p. 76	• RT Indicator*5	p. 77
• Dual/Tri-Watch	p. 76	• CH Display*6	p. 77
• CHAN Group	p. 76		

◇ Configuration

Item	Ref.	Item	Ref.
• Backlight	p. 78	• Noise Cancel	p. 80
• Display Contrast	p. 78	• Inactivity Timer	p. 81
• Key Beep	p. 78	• NMEA Output	p. 82
• Key Assignment	p. 78	• Remote ID	p. 83
• UTC Offset	p. 80	• COMMANDMIC SP*4	p. 83

◇ MMSI/GPS Info

The transceiver shows the preset MMSI and ATIS*7 codes and GPS information*8.

If the code is not entered, “NO DSC MMSI” or “NO ATIS MMSI”*7 is displayed.

*7 Displayed only for the Dutch and German version transceivers.

*8 Displayed only when an external or the built-in GPS receiver is receiving valid position data.

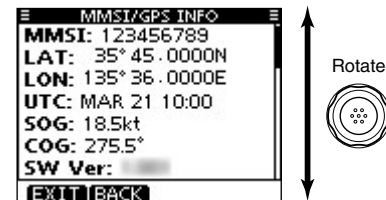

■ Radio Settings items

◇ Scan type

The transceiver has two scan types, Normal scan and Priority scan. A Normal scan searches all Favorite channels in the selected channel group. A Priority scan sequentially searches all Favorite channels, while monitoring Channel 16.

- The default setting is different depending on the transceiver versions.

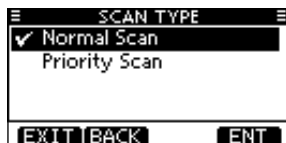

◇ Scan resume timer

The scan resume timer can be selected as a pause (OFF) or timer scan (ON). When OFF is selected, the scan pauses until the signal disappears. (Default: OFF)

- **Priority scan** When ON is selected, the scan pauses for 5 seconds and then resumes, even if a signal has been received on any channel other than Channel 16.
- **Normal scan** When ON is selected, the scan pauses for 5 seconds and then resumes, even if a signal has been received on any channel.



◇ Dual/Tri-watch

This item can be selected as Dualwatch or Tri-watch. (p. 21)
(Default: Dualwatch)



◇ Channel Group

Except for the European version, a channel group suitable for your operating area can be selected. Depending on the transceiver version, INT, USA, CAN, ATIS, or DSC may be selectable.

See page 12 for details.

- The screen below shows the USA version.



◇ **Weather alert**

(For only USA and Australian version transceivers)

A NOAA broadcast station transmits a weather alert tone before important weather information.

After the transceiver detects the alert, “WX ☁” blinks until the transceiver is operated.

- “WX ☁” displayed instead of “WX” when the function is set ON.
(Default: OFF)

ON with Scan: The preset weather channels are sequentially checked while scanning.

ON: The previously selected (last used) weather channel is checked while scanning.

OFF: The transceiver does not detect a weather alert tone.

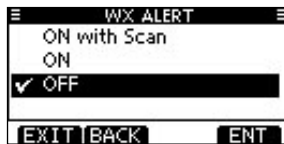

◇ **RT Indicator**

(For only USA version transceivers)

Select weather or not to display RT (Radio Telephone) icon (p. 6) while in the Radio Telephone mode. (Default: ON)

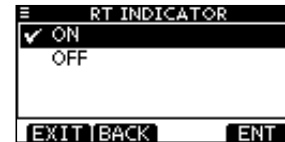

◇ **CH Display**

You can select the number of digits to display the channel number. (Default: 4 Digits)

- This setting may not be usable, depending on the transceiver version or presetting.

3 Digits: The channel number is displayed in 3 digits, such as “01A.”

4 Digits: The channel number is displayed in 4 digits, such as “1001.”



■ Configuration items

◇ Backlight

The function display and keys can be backlit for better visibility under low light conditions.

The backlight can be set to 7 levels and OFF. (Default: 7)



◇ Display contrast

This item adjusts the contrast of the LCD in 8 steps.

Level 1 is the lowest contrast, and level 8 is the highest contrast. (Default: 5)

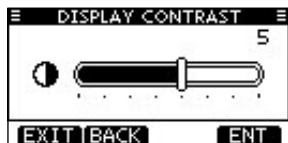

◇ Key Beep

You can turn OFF beep tones for silent operation, or you can turn ON the tones to have confirmation beeps sound when a key is pushed. (Default: ON)

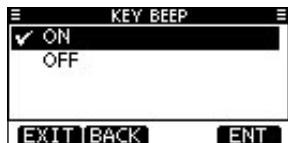

◇ Key Assignment

Desired functions can be assigned to Dial and the softkeys.

- ① When the “KEY ASSIGNMENT” screen is displayed, rotate Dial or push [▲]/[▼] to select “Dial” or “Softkeys,” and then push [ENT].
- ② Rotate Dial or push [▲]/[▼] to select the desired position, and then push [ENT].
 - To return to the default, select “Set default” and push [ENT].

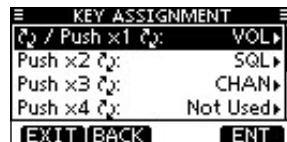

For “Dial” assignment

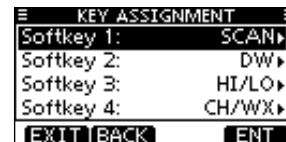

For “Softkeys” assignment

- ③ Rotate Dial or push [▲]/[▼] to select the option, and then push [ENT] to set it.
 - “✓” is displayed next to the selected option.

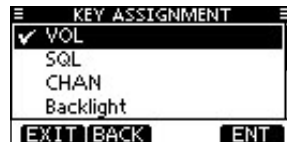

For “Dial” assignment

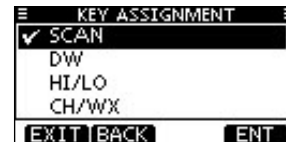

For “Softkeys” assignment*

* [CHAN] is displayed instead of [CH/WX] for the IC-M423, IC-M423G, and IC-M423GE except for Australian version.

- ④ Push [EXIT] to exit the Menu screen.
- Push [CLEAR] or [BACK] to return to the previous screen.

• Dial assignment

The Audio volume (VOL), squelch (SQL), channel selection (CHAN), and LCD backlight level (Backlight) functions can be assigned to any one of 4 sequential positions on Dial. Pushing Dial 1 to 4 times sequentially selects the desired function, and rotating Dial adjusts the level or selects a value or number.

For example:

- VOL is assigned the 1st position, and pushing Dial once selects VOL. The VOL adjust screen is displayed and rotating Dial adjusts the audio volume.
- CH is assigned to the 3rd position, and pushing Dial three times selects CH. The channel number is displayed and rotating Dial will select the desired channel.

You can assign VOL, SQL, CH/WX* and Backlight to any one of the 1st, 2nd, 3rd, or 4th sequential positions.

Repeatedly pushing Dial sequentially displays all the functions in the order they are assigned, and skips any functions assigned as Not Used.

* [CHAN] is displayed instead of [CH/WX] for the IC-M423, IC-M423G, and IC-M423GE except for Australian version.

• Softkeys assignment

The desired function can be assigned as the softkey function. The assigned function can be used when its key icon is displayed.

See page 3 through 4 for details of the assignable key functions.

9 MENU SCREEN OPERATION

■ Configuration items (Continued)

◇ UTC Offset

Set the offset time between the UTC (Universal Time Coordinated) and your local time to between -14:00 and +14:00 (in 1 minute steps). (Default: 00:00)



◇ Noise Cancel

Set the Noise Cancel function for both receive and transmit.

- ① When the "NOISE CANCEL" screen is displayed, rotate Dial or push [▲]/[▼] to select "RX" or "TX," and then push [ENT].

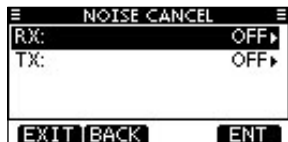

- ② Rotate Dial or push [▲]/[▼] to select the option, and then push [ENT] to set it.
 - "✓" is displayed next to the selected option.
- ③ Push [EXIT] to exit the Menu screen.
 - Push [CLEAR] or [BACK] to return to the previous screen.

• RX

Turn the receive Noise Cancel function ON or OFF.

OFF: Turns OFF the function. (Default)

- 1 : The Noise Cancel function reduces random noise components in the received signal to approximately one half.
- 2 : The Noise Cancel function reduces random noise components in the received signal to approximately one third.
- 3 : The Noise Cancel function reduces random noise components in the received signal to approximately one tenth.

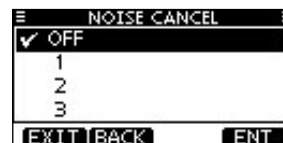

• TX

Turn the transmit Noise Cancel function ON or OFF.

OFF : Turns OFF the function. (Default)

ON : The Noise Cancel function reduces random noise components in the transmitted signal to one third.

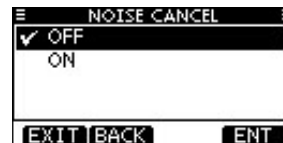

◇ **Inactivity Timer**

Set the inactivity timer to between 1 and 10 minutes (in 1 minute steps) or OFF for a “Not DSC Related” item, and set it to between 1 and 15 minutes (in 1 minute steps) or OFF for a “DSC Related” item. The count down alarm sounds 10 seconds before the Inactive timer returns the current screen to the normal operating screen.

- ① When the “INACTIVITY TIMER” screen is displayed, rotate Dial or push [▲]/[▼] to select “Not DSC Related” or “DSC Related,” and then push [ENT].
 - “✓” is displayed next to the selected option.
- ② Rotate Dial or push [▲]/[▼] to select the option, and then push [ENT] to set it.
 - Push [EXIT] or [BACK] to return to the previous screen.
- ③ Push [EXIT] to exit the Menu screen.
 - Push [CLEAR] or [BACK] to return to the previous screen.

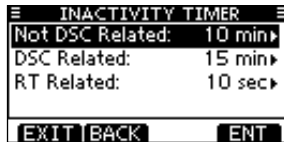

• **Not DSC Related**

When the LCD displays a screen other than the normal operation screen, or one not related to the DSC, and no key operation occurs for this set period, the transceiver automatically returns to the normal operating screen. (Default: 10 min)



• **DSC Related**

When the LCD displays the screen related to DSC, and no key operation occurs for this set period, the transceiver automatically returns to the normal operating screen. (Default: 15 min)



• **RT Related** (For only USA version transceivers)

While receiving or transmitting a signal, and when the channel is changed, the RT (Radio Telephone) icon is displayed.

The icon disappears if you push no key for the period of time set in the Menu screen shown below. (Default: 30 sec)



9 MENU SCREEN OPERATION

■ Configuration items (Continued)

◇ NMEA Output

Select the Data Output function option for a NMEA output port.

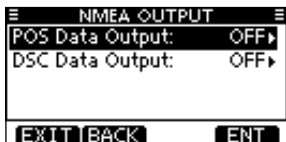

• POS data output (Default: OFF)

When receiving position data from an external or the built-in GPS receiver,* this function sends the data from the NMEA Output port to an external device.

*For only the IC-M423G, IC-M423GE, and IC-M424G.

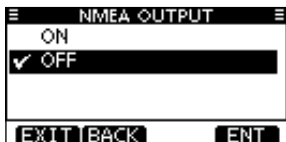

• DSC data output (Default: OFF)

When receiving a DSC call, this function makes the transceiver send the DSC data from its NMEA Output port to an external device.

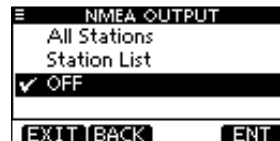

All Stations: Outputs the call from any vessel from the NMEA Output port.

Station List: Outputs the call from any vessels listed on the Individual ID screen.

OFF: Does not output any call to an external device.

◇ Remote ID

Set a Remote ID number to between 1 and 69.

The Remote ID is included in the sentence of the Icom original NMEA format. (Default: 15)

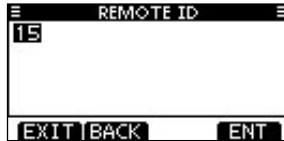

◇ COMMANDMIC Speaker

(Displayed only when the optional HM-195 is connected.)

The HM-195's external speaker can be used instead of the internal speaker. (Default: Internal Speaker)

- The "COMMANDMIC SP" screen is displayed on the HM-195's display. Not displayed on the transceiver's display.

Internal Speaker : Turns ON the internal speaker. (Default)

External Speaker : Turns ON the external speaker.



/// Regardless of this setting, the supplied microphone's speaker is ON.

10 CONNECTIONS AND MAINTENANCE

■ Connections

- The figure shows the IC-M423GE.

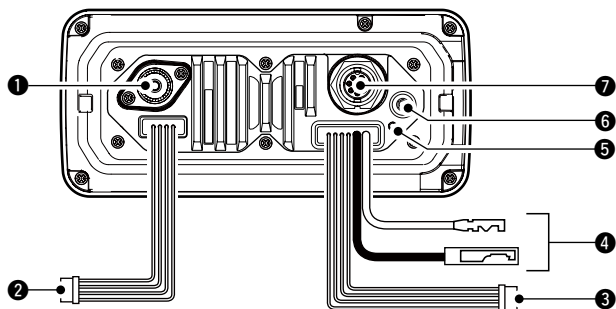

1 ANTENNA CONNECTOR

Connects to a marine VHF antenna cable's PL-259 connector.

⚠ **CAUTION: DO NOT** transmit without an antenna.

2 NMEA IN/OUT LEADS

Brown: Talker B (Data-L), Data Out (-)

White: Talker A (Data-H), Data Out (+)

Connect to NMEA input lines of navigation equipment, to receive position data of other ships.

- A NMEA 0183 (ver. 2.0 or later) sentence format DSC or DSE compatible navigation equipment is required.
- The built-in GPS outputs RMC, GSA, GSV format sentences.

Green: Listener B (Data-L), GPS In (-)

Yellow: Listener A (Data-H), GPS In (+)

Connect to NMEA output lines of a GPS receiver for position data.

- A NMEA 0183 ver. 2.0 or later RMC, GGA, GNS, GLL, VTG, GSV, and GSA sentence format compatible GPS receiver is required. Ask your dealer about suitable GPS receivers.
- The GPS sentences input from an external GPS receiver have priority over the sentences from the built-in GPS.

3 AF OUT LEADS

Blue: External Speaker (+)

Black: External Speaker (-)

Connects to an external speaker.

Orange: Public Address Speaker (+)

Gray: Public Address Speaker (-)

Connects to a PA speaker.

- PA output power: More than 10 W at 10% distortion into a 4 Ω load

⚠ **DO NOT** connect the black or grey leads to the ground.

⚠ These leads must be connected to the External speaker (-) or Public Address Speaker (-) lines.

NOTE for NMEA In/Out and AF Out leads:

⚠ The connectors are attached to keep the leads together. Before connecting to a piece of equipment, you should cut the leads to remove the connector.

4 DC POWER CONNECTOR

Connects to a 13.8 V DC power source. (+: Red, -: Black)

CAUTION: After connecting the DC power cable, NMEA leads, external speaker leads, and PA speaker leads, cover the connector and leads with an vulcanizing tape, as shown below, to prevent water seeping into the connection.

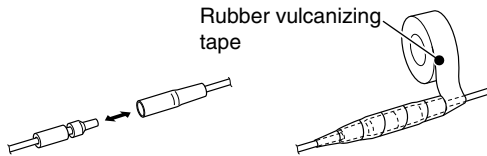

5 GROUND TERMINAL

Connects to a vessel ground to prevent electrical shocks and interference from other equipment occurring.

Use a PH M3 x 6 screw (user supplied).

NOTE for the IC-M423, IC-M423G, IC-M424, and IC-M424G: The location of the ground terminal is the same as the GPS antenna connector on the IC-M423GE.

6 GPS ANTENNA CONNECTOR

Connects to the supplied GPS antenna. (For only the IC-M423GE)

NOTE: Be sure the GPS antenna is positioned where it has a clear view to receive signal from satellites, and fixed using the supplied double-sided adhesive pad.

7 COMMAND MICROPHONE JACK

Connects to the optional Command microphone. (p. 89)

◇ Connecting to the MA-500TR/MA-510TR

An Individual DSC call can be made to the AIS target using the transponder without entering the target's MMSI code.

See the transponder's instruction manual for connection details.

Connect each lead to the appropriate lead of the OPC-2014 as follows.

- Listener A (Data-H) (Yellow): To lead 3.
- Listener B (Data-L) (Green): To lead 2.
- Talker A (Data-H) (White): To lead 5.
- Talker B (Data-L) (Brown): To lead 4.

NOTE: This instruction is for the MA-500TR. See the MA-510TR Instruction manual for the MA-510TR's connecting instructions.

10 CONNECTIONS AND MAINTENANCE

■ Antenna

A key element in the performance of any communication system is the antenna. Ask your dealer about antennas and the best place to mount them.

■ Fuse replacement

One fuse is installed in the supplied DC power cable. If the fuse blows or the transceiver stops functioning, track down the source of the problem, repair it, and replace the damaged fuse with a new one of the proper rating.

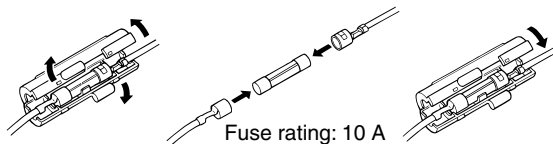

■ Cleaning

If the transceiver becomes dusty or dirty, wipe it clean with a soft, dry cloth.



DO NOT use harsh solvents such as benzene or alcohol, as they will damage the transceiver's surfaces.

■ Supplied accessories

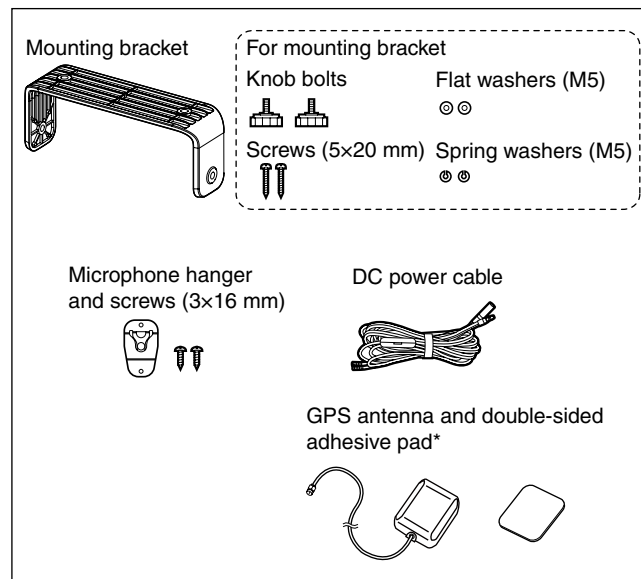

*Not supplied, or the type is different, depending on the transceiver's versions.

■ Mounting the transceiver

◇ Using the supplied mounting bracket

The universal mounting bracket supplied with your transceiver allows overhead or dashboard mounting.

- ① Mount the bracket securely to a surface which is more than 10 mm thick and can support more than 5 kg using the two supplied screws (5 × 20 mm).
- ② Attach the transceiver to the bracket so that the face of the transceiver is at 90° to your line of sight when operating it.

KEEP the transceiver and microphone at least 1 meter away from the vessel's magnetic navigation compass.

NOTE: Check the installation angle; the function display may not be easy-to-read at some angles.

NOTE for the IC-M423G and IC-M424G:

Built-in GPS receiver is located at the right top of the front panel.

If the transceiver is covered with any object that interrupts the GPS signals from the satellites, the GPS receiver will not calculate its position.

Therefore, when you use the built-in GPS receiver, be sure the transceiver is positioned so the GPS receiver has a clear view to receive signals from satellites.

NOTE for the IC-M423GE: Be sure the GPS antenna is positioned where the GPS antenna has a clear view to receive signal from satellites, and fixed using the supplied double-sided adhesive pad.

• MOUNTING EXAMPLE

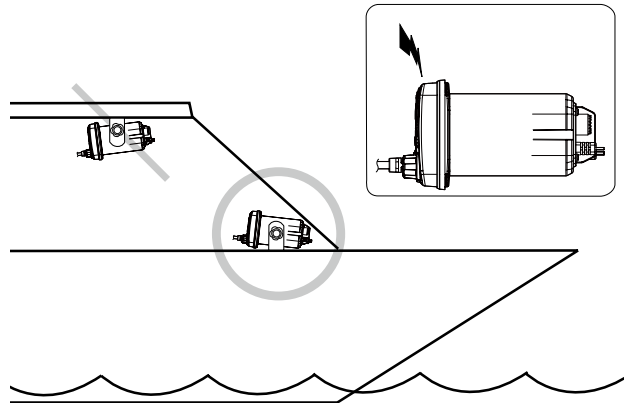
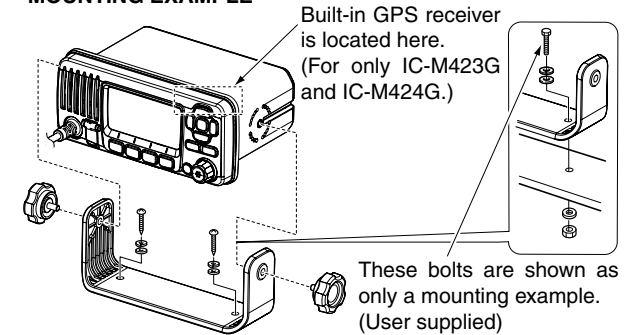

10 CONNECTIONS AND MAINTENANCE

■ MB-132 installation

An optional MB-132 FLUSH MOUNT is available for mounting the transceiver to a flat surface, such as an instrument panel.

KEEP the transceiver and microphone at least 1 meter away from your vessel's magnetic navigation compass.

- ① Using the template on page 95, carefully cut a hole into the instrument panel, or wherever you plan to mount the transceiver.
- ② Slide the transceiver through the hole, as shown below.

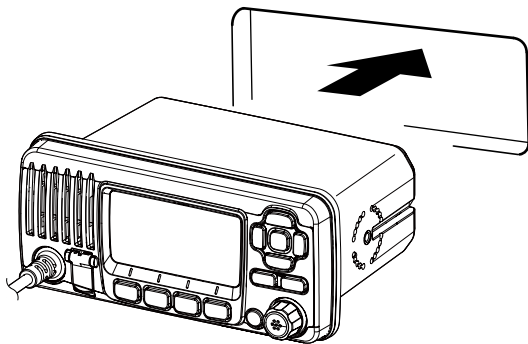

- ③ Attach the clamps on either side of the transceiver with two M5 × 8 mm supplied bolts.
 - Make sure that the clamps align parallel to the transceiver body.

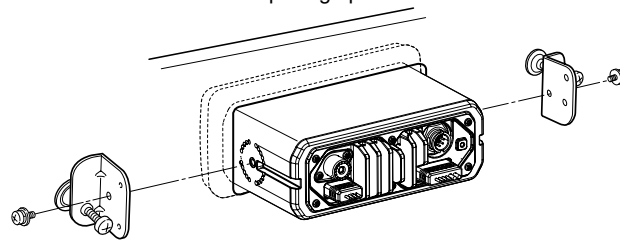

- ④ Tighten the end bolts on the clamps (clockwise) so that the clamps press firmly against the inside of the instrument control panel.
- ⑤ Tighten the locking nuts (counterclockwise) so that the transceiver is securely mounted in position, as shown below.
- ⑥ Connect the antenna and power cable, then return the instrument control panel to its original place.

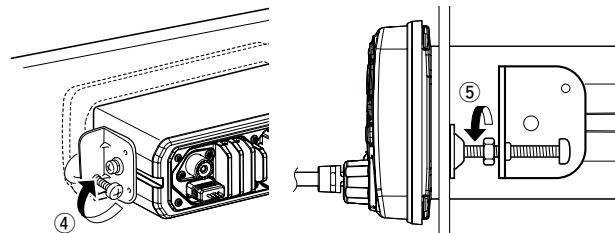

■ Microphone installation

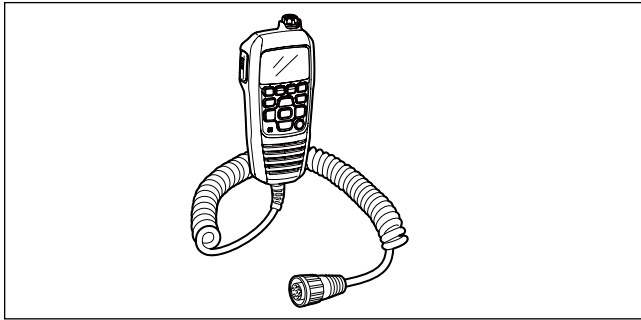

The optional HM-195 should be connected to the transceiver using the supplied OPC-1540 connection cable.

The cable is used to operate from a longer distance. The cable connector can also be installed as a built-in plug on a cabinet or wall.

To operate from even longer distances, the optional 6 meter long OPC-1541 extension cable can be used between the transceiver and the OPC-1540. Up to two OPC-1541 can be added.

◆ Installation

- ① Insert the OPC-1540 cable connector into the command microphone jack, and tighten the nut.
- ② To use the cable connector as a wall socket, install it as described to the right.

- ③ Using the mounting base as a template, carefully mark the holes where the cable and three screws will be fastened.
- ④ Drill holes at these marks.
- ⑤ Install the mounting base using the supplied screws, as shown below.

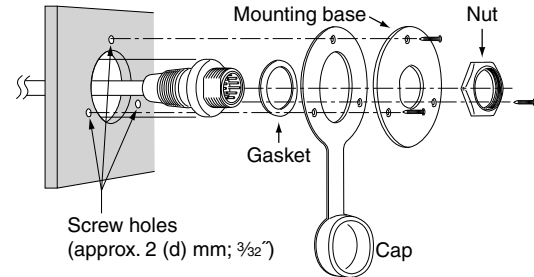

- ⑥ The completed installation should look like this.

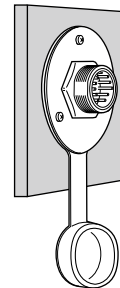

10 CONNECTIONS AND MAINTENANCE

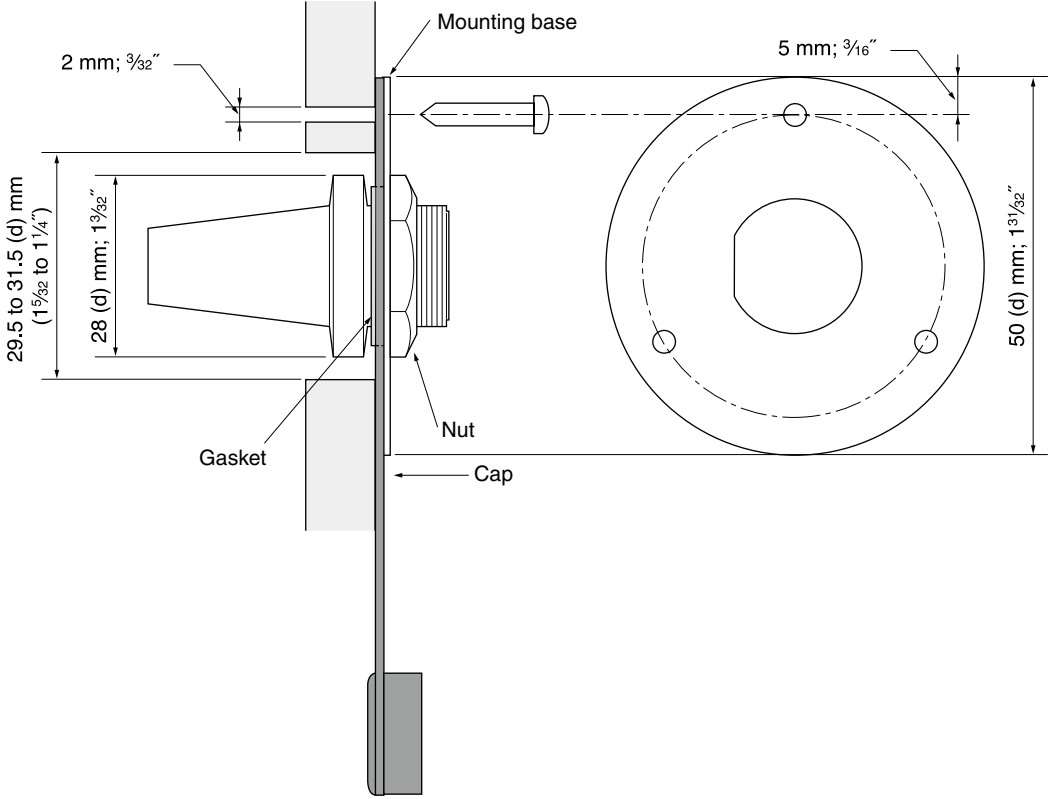

■ Specifications

◇ General

- Frequency coverage:

Tx IC-M423/IC-M423G/IC-M423GE	156.000–161.450 MHz
IC-M424/IC-M424G	156.025–157.425 MHz
IC-M423 (CHN/AUS version)	156.025–157.425 MHz
Rx IC-M423/IC-M423G/IC-M423GE	156.000–163.425 MHz
IC-M424/IC-M424G	156.050–163.275 MHz
IC-M423 (AUS version)	156.050–163.275 MHz
IC-M423 (CHN version)	156.050–162.025 MHz
CH70	156.525 MHz
- Mode:

16K0G3E (FM)	
16K0G2B (DSC)	
- Channel spacing: 25 kHz
- Operating temperature range:

–20°C to +60°C;	
–4°F to +140°F	
- Current drain (at 13.8 V):

TX high	5.5 A maximum
Maximum audio	5.0 A maximum
- Power requirement:

(negative ground)	13.8 V DC nominal
-------------------	-------------------
- Frequency stability:

±1.5 kHz (–20°C to +60°C;	
–4°F to +140°F)	
- Antenna impedance: 50 Ω nominal
- Dimensions (approximate):

180(W) × 82(H) × 119.9(D) mm	
; 7.1(W) × 3.2(H) × 4.7(D) inches	
(Projections not included)	
- Weight (approximate): 1.2 kg; 2.6 lb

◇ Transmitter

- Output power: 25 W/1 W
- Modulation system: Variable reactance frequency modulation
- Maximum frequency deviation: ±5.0 kHz
- Spurious emissions:

IC-M423/IC-M423G/IC-M423GE	Less than 0.25 μW
IC-M424/IC-M424G	Less than –70 dBc (high)
	Less than –56 dBc (low)
IC-M423 (CHN/AUS version)	Less than –70 dBc (high)
	Less than –56 dBc (low)

◇ Receiver

- Receive system: Double conversion superheterodyne
- Sensitivity:

FM	IC-M423/IC-M423G/IC-M423GE	–5 dBμ emf typical (at 20 dB SINAD)
	IC-M424/IC-M424G	–13 dBμ typical (at 12 dB SINAD)
	IC-M423	
	(CHN/AUS version)	–13 dBμ typical (at 12 dB SINAD)
DSC	IC-M423/IC-M423G/IC-M423GE	–4 dBμ emf typical (1% BER)
	IC-M424/IC-M424G	–5 dBμ emf typical (1% BER)
	IC-M423	
	(CHN/AUS version)	–5 dBμ emf typical (1% BER)
- Squelch sensitivity:

IC-M423/IC-M423G/IC-M423GE	Less than –2 dBμ emf
IC-M424/IC-M424G	Less than –10 dBμ
IC-M423 (CHN/AUS version)	Less than –10 dBμ

☞ Continued on the next page.

All stated specifications are subject to change without notice or obligation.

11 SPECIFICATIONS AND OPTIONS

■ Specifications

◇ Receiver (continued)

• Intermodulation rejection ratio:

FM IC-M423/IC-M423G/IC-M423GE

More than 68 dB

IC-M424/IC-M424G More than 70 dB

IC-M423

(CHN/AUS version) More than 70 dB

DSC More than 68 dB μ emf (1% BER)

• Spurious response rejection ratio:

FM More than 70 dB

DSC More than 73 dB μ emf (1% BER)

• Adjacent channel selectivity:

FM More than 70 dB

DSC More than 73 dB μ emf (1% BER)

• Audio output power:

IC-M423/IC-M423G/IC-M423GE
More than 10 W at 10% distortion
into a 4 Ω load

IC-M424/IC-M424G 10 W at 10% distortion into a 4 Ω load

IC-M423 (CHN/AUS version) 10 W at 10% distortion into a 4 Ω load

◇ GPS (IC-M423GE)

• Frequency: 1575.42 MHz

• Channel: 66 ch

◇ Dimensions

Unit: mm (inch)

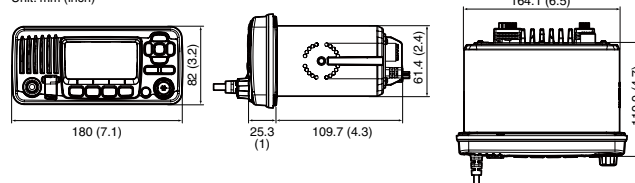

■ Options

• MB-132 FLUSH MOUNT KIT

To mount the transceiver to a panel.

• MA-500TR/MA-510TR* CLASS B AIS TRANSPONDER

To transmit individual DSC calls to a selected AIS targets.

* Unreleased as of April 2020.

• HM-195 COMMANDMICIV™

External microphone-type controller. Provides optional intercom operation. A 6 m (20 ft) microphone cable and mounting base are included.

HM-195B: Black

HM-195SW: Super White

• OPC-1541 MICROPHONE EXTENSION CABLE

A 6 m (20 ft) microphone extension cable for the optional HM-195 COMMANDMICIV™. Up to two OPC-1541s can be connected. Maximum usable length is 18 m (60 ft).

CHANNEL LIST 12

Channel Number			Frequency (MHz)	
USA*10	INT	CAN*5	Transmit	Receive
	01	01	156.050	160.650
1001	1001*5		156.050	156.050
	02	02	156.100	160.700
	03	03	156.150	160.750
	04		156.200	160.800
		1004	156.200	156.200
	05		156.250	160.850
1005	1005*5	1005	156.250	156.250
06	06	06	156.300	156.300
	07		156.350	160.950
1007	1007*5	1007	156.350	156.350
08	08	08	156.400	156.400
09	09	09	156.450	156.450
10	10	10	156.500	156.500
11	11	11	156.550	156.550
12	12	12	156.600	156.600
13*1	13	13*2	156.650	156.650
14	14	14	156.700	156.700
15*4	15*2	15*2	156.750	156.750
16	16	16	156.800	156.800
17*2	17*3	17*2	156.850	156.850
	18*3		156.900	161.500
1018	1018*5	1018	156.900	156.900
	19		156.950	161.550
1019	1019	1019	156.950	156.950
	2019		RX only	161.550
20	20	20*2	157.000	161.600
1020	1020		157.000	157.000
	2020		RX only	161.600

Channel Number			Frequency (MHz)	
USA*10	INT	CAN*5	Transmit	Receive
	21		157.050	161.650
1021	1021*5	1021	157.050	157.050
		2021	RX only	161.650
	22		157.100	161.700
1022	1022*5	1022	157.100	157.100
	23	23	157.150	161.750
1023	1023*5		157.150	157.150
		2023*5	RX only	161.750
24	24*6	24	157.200	161.800
25	25*6	25	157.250	161.850
		2025	RX only	161.850
26	26*6	26	157.300	161.900
27	27	27	157.350	161.950
	1027*5		157.350	157.350
28	28	28	157.400	162.000
	1028*5		157.400	157.400
		2028	RX only	162.000
	31*2/9		157.550	162.150
1037*7	1037*8		157.850	157.850
	60	60	156.025	160.625
	61		156.075	160.675
		1061	156.075	156.075
	62		156.125	160.725
		1062	156.125	156.125
	63		156.175	160.775
1063	1063*5	1063*5	156.175	156.175
	64	64	156.225	160.825
		1064	156.225	156.225
	65		156.275	160.875

Channel Number			Frequency (MHz)	
USA*10	INT	CAN*5	Transmit	Receive
1065	1065*5	1065*2	156.275	156.275
	66		156.325	160.925
1066	1066*5	1066*2	156.325	156.325
67*1	67	67	156.375	156.375
68	68	68	156.425	156.425
69	69	69	156.475	156.475
71	71	71	156.575	156.575
72	72	72	156.625	156.625
73	73	73	156.675	156.675
74	74	74	156.725	156.725
	75*2	75*2	156.775	156.775
	76*2	76*2	156.825	156.825
77*2	77	77*2	156.875	156.875
	78		156.925	161.525
1078	1078	1078	156.925	156.925
	2078		RX only	161.525
	79		156.975	161.575
1079	1079	1079	156.975	156.975
	2079		RX only	161.575
	80		157.025	161.625
1080	1080*5	1080	157.025	157.025
	81		157.075	161.675
1081	1081*5	1081	157.075	157.075
	82		157.125	161.725
1082	1082*5	1082	157.125	157.125
	83		157.175	161.775
1083	1083*5	1083	157.175	157.175
		2083	RX only	161.775
84	84*6	84	157.225	161.825

Channel Number			Frequency (MHz)	
USA*10	INT	CAN*5	Transmit	Receive
85	85*6	85	157.275	161.875
86	86*6	86	157.325	161.925
87	87	87	157.375	157.375
88	88	88	157.425	157.425
P4*7	P4*7		161.425	161.425

NOTE:

- Simplex channels, 1021, 1023, 1081, 1082 and 1083 **CANNOT** be lawfully used by the general public in USA waters.
- When the "CH Display" setting in the Menu screen is set to "3 Digits," the channel number is displayed in 3 digits. (For example, "1001" is displayed as "01A.")

*1 Momentary high power.

*2 Low power only.

*3 Low power only for the UK, EUR, Dutch and German versions.

*4 RX only for the USA and UK versions.

*5 For only the USA and EXP versions.

*6 For only the UK, EUR, Dutch and German versions.

*7 UK Marina Channels: M1=1037 (157.850 MHz), M2=P4 (161.425 MHz) for only the U.K. version.

*8 For only the Dutch and UK versions (UK Marina Channel: M1=1037 (157.850 MHz) for the U.K. version).

*9 For only the Dutch version.

*10 For only the USA, EXP, and UK versions.

13 TROUBLESHOOTING

PROBLEM	POSSIBLE CAUSE	SOLUTION	REF.
The transceiver does not turn ON.	<ul style="list-style-type: none"> • Bad connection to the power source. 	<ul style="list-style-type: none"> • Check the connection to the transceiver and power source. 	p. 84
Little or no sound comes from the speaker.	<ul style="list-style-type: none"> • Squelch level is set too high. • Volume level is set too low. • Speaker has been exposed to water. 	<ul style="list-style-type: none"> • Set the squelch to the threshold point. • Set the volume to a suitable level. • Remove the water with the AquaQuake function. 	p. 15 p. 15 p. 18
Transmitting is impossible, or high power cannot be selected.	<ul style="list-style-type: none"> • Some channels are restricted to low power or receive only by regulations. • The output power is set to low. 	<ul style="list-style-type: none"> • Change channels. • Push [HI/LO] to select high power. 	pp. 11, 12, 13 p. 14
Scan does not start.	<ul style="list-style-type: none"> • Favorite channels are not entered. 	<ul style="list-style-type: none"> • Set the desired channels as Favorite channels. 	p. 20
No beep sounds.	<ul style="list-style-type: none"> • Beep tones are turned OFF. 	<ul style="list-style-type: none"> • Turn ON the beep tones in the CONFIGURATION menu. 	p. 78
Distress calls cannot be transmitted.	<ul style="list-style-type: none"> • MMSI (DSC self ID) code is not entered. 	<ul style="list-style-type: none"> • Enter the MMSI (DSC self ID) code. 	p. 9
<p>“NO POSITION” and “NO TIME” are displayed instead of the position and time.</p> <p>(For only IC-M423G, IC-M423GE, and IC-M424G)</p>	<ul style="list-style-type: none"> • The GPS signal is not correctly received. • The position and time have not been manually entered. 	<ul style="list-style-type: none"> • Mount the transceiver in a place where no objects interrupts the satellites signal. (For only the IC-M423G and IC-M424G) • Check the GPS antenna is positioned where it has a clear view to receive signal from satellites. (For only the IC-M423GE) • Enter the position and time. 	p. 87 p. 25

TEMPLATE 14

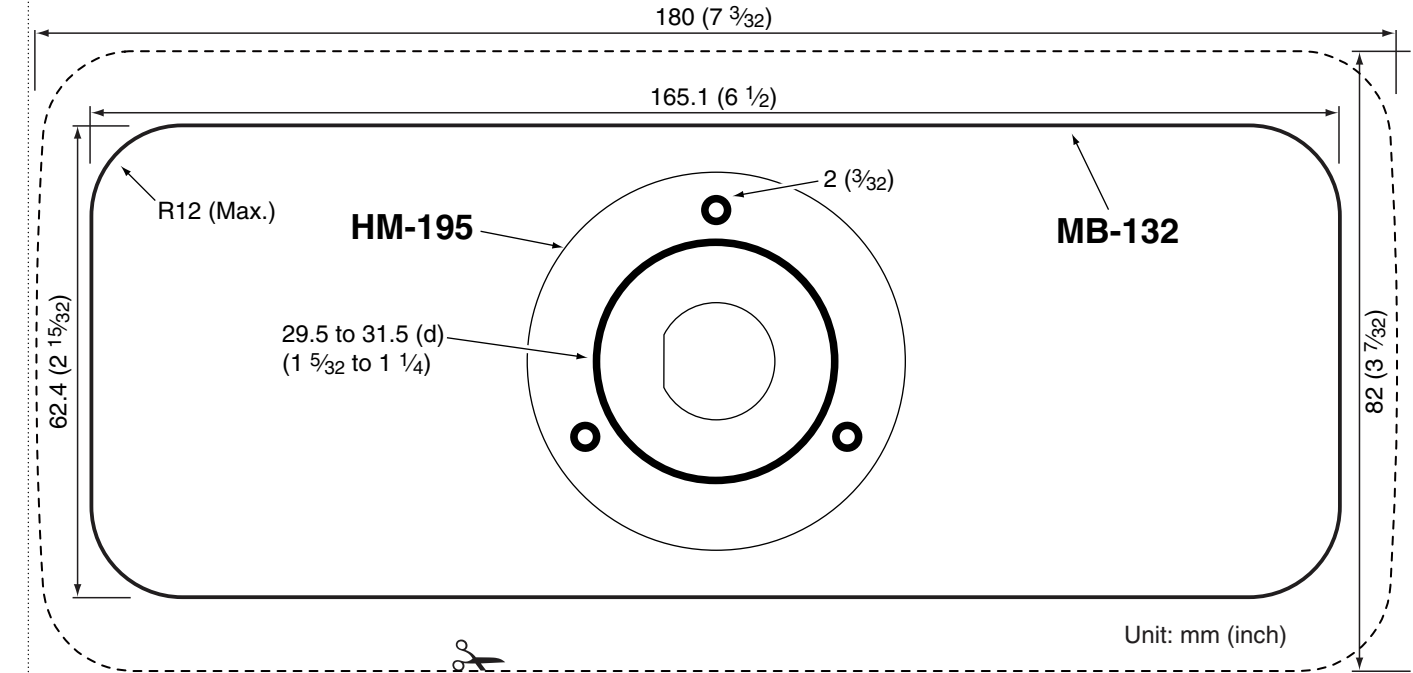

Cut here

13
14

■ About CE and DOC

CE Hereby, Icom Inc. declares that the versions of IC-M423/IC-M423G/IC-M423GE which have the “CE” symbol on the product, comply with the essential requirements of the Radio Equipment Directive, 2014/53/EU, and the restriction of the use of certain hazardous substances in electrical and electronic equipment Directive, 2011/65/EU. The full text of the EU declaration of conformity is available at the following internet address:

<https://www.icomjapan.com/support/>

■ Disposal



The crossed-out wheeled-bin symbol on your product, literature, or packaging reminds you that in the European Union, all electrical and electronic products, batteries, and accumulators (rechargeable batteries) must be taken to designated collection locations at the end of their working life. Do not dispose of these products as unsorted municipal waste. Dispose of them according to the laws in your area.

INDEX

A	D	H
Accessories, supplied..... 86	Display contrast..... 78	Horn 73
Acknowledgement, Automatic 65	Disposal..... 97	
Alarm 67	Distress Acknowledgement 55	I
All Ships call	Distress Call	IMPORTANT..... i
Making a call.....38	Making a call 26	Inactivity Timer..... 81
Receiving a Call..... 58	Canceling a call..... 29	Individual Call
Antenna 86	Receiving a Call 55	Making a call..... 32
AquaQuake..... 18	Distress Relay Acknowledgement ... 56	Making an acknowledgement 34
ATIS code 10	Distress Relay Call 56	Receiving a call 57
	DSC Loop Test..... 68	Individual ID
B	DSC Settings..... 65	Entering ID 22
Backlight level..... 18	DUALWATCH/TRI-WATCH 21	Deleting ID..... 24
C		Intercom..... 71
Call channel	E	Installation
Selecting a Call channel 11	Explicit Definitions i	Template 95
Entering a Call channel 16	F	K
Call log	Favorite channels 20	Key Assignment..... 78
Received Call log..... 63	Front panel..... 2	Key Beep 78
Transmitted Call log..... 62	Function display..... 5	M
Channel 16 11	Fuse replacement..... 86	MB-132 installation..... 88
Channel 16 Switch function..... 66	G	Menu screen
Channel 70 Squelch level..... 67	Geographical Area Call 58	Menu screen items 75
Channel group 12	Group call	Using the Menu screen..... 74
Channel List..... 93	Making a call..... 36	Microphone installation..... 89
Channel Name..... 16	Receiving a Call..... 58	Microphone Lock function..... 17
CH Display..... 77	Group ID	MMSI code 9
Cleaning 86	Entering ID 23	Mounting the transceiver 87
COMMANDMIC Speaker..... 83	Deleting ID..... 24	
Connections..... 84		

N

NMEA Output 82

Noise Cancel 80

O

Operating Rules..... 1

Operation, basic 11

Options 92

P

PA (Public Address)..... 72

Polling Request Call

 Making a call 43

 Making a reply call 53

 Receiving a call 61

Position and time 25

Position Report Call

 Making a call 41

 Making a reply call 51

 Receiving a call 60

Position Request Call

 Making a call 39

 Making a reply call 49

 Receiving a call 59

PRECAUTIONS (English).....vi

PRÉCAUTIONS (Français).....vii

R

Receiving..... 14

Remote ID 83

RX Speaker 72

S

Scan

 Scan resume timer 76

 Scan types 19

 Starting a scan 20

Softkey function 7

Specifications 91

Speaker Microphone 8

Squelch..... 15

T

Test Acknowledgement call

 Making a call 47

 Receiving a call 62

Test call

 Making a call 45

 Making an acknowledgement..... 47

 Receiving a call 61

Transmitting 14

Troubleshooting 94

U

UTC Offset..... 80

V

volume 15

W

Weather alert..... 77

Weather channel 13

Count on us!

A7197D-1EX-8a
Printed in Japan
© 2014–2020 Icom Inc.

Jul. 2020

Icom Inc.

1-1-32 Kamiminami, Hirano-ku, Osaka 547-0003, Japan