

# KI-396-SMA-II

HIGH OUTPUT 15" 2-WAY LOUDSPEAKER



# Klipsch®

KLIPSCH PROFESSIONAL | PERMANENT INSTALLATION | DATA SHEET



## PRODUCT OVERVIEW

The Klipsch KI-396-SMA-II has incredible output capability with exceptional low-distortion clarity. The compact 22.5° symmetrical, trapezoidal design houses a 15" high-excursion cast frame heavy-duty woofer, a large 3" titanium high-frequency compression driver and a 90° x 60° Tractrix® Horn for tight pattern control.

The loudspeaker enclosure is constructed using a 3/4" 7-ply birch plywood, and a 1" medium density fiberboard front motorboard. The KI-396-SMA-II is available in black or white using a laquer-based finish, or unfinished Raw Birch.

The KI-396-SMA-II permanent install speaker has 16 suspension points (4 per side) for flexible mounting and rigging bar compatibility and includes top and bottom mounting locations for a C-bracket.

## FEATURES

- Very high output capability with exceptional low-distortion clarity
- Compact 22.5° symmetrical trapezoidal design
- 16 suspension points for (4 per side) for flexible mounting and rigging bar compatibility
- 15" cast frame heavy-duty woofer
- Large 3" (7.62cm) titanium diaphragm high-frequency compression driver
- Internal high current full-range crossover
- Available in Black, White or Raw Birch finish

## APPLICATIONS

- Performing Spaces
- Auditoriums and Houses of Worship
- Bars and Music Clubs
- Small/medium Sports Facilities
- Theme Parks and Leisure Venues
- Transportation Facilities

## DESIGNED AND MADE IN THE USA USING DOMESTIC AND IMPORTED COMPONENTS

In 1946, Paul W Klipsch, genius & maverick, hand-built his first loudspeaker in a tin shed with the intention of bringing live music into his living room. Remember great sound? We do, too. Today, Klipsch's KI series speaker enclosures are made in the USA, by proud craftsmen in Hope, Arkansas. Just like PWK intended.

## SPECIFICATIONS

<b>FREQUENCY RESPONSE<sup>1</sup></b> (+/- 3 dB)	60 Hz - 18 kHz (-10 dB @ 35 Hz)
<b>POWER HANDLING<sup>2</sup></b>	600 watts (56V) 2400 watts peak
<b>MAXIMUM SPL<sup>3</sup></b>	127 dB Continuous 133 dB Peak
<b>SENSITIVITY<sup>4</sup></b>	101 dB
<b>COVERAGE</b>	Horizontal: 90° +/- 30° 400 Hz - 13 kHz Vertical: 60° +/- 20° 1.6 kHz - 20 kHz
<b>DIRECTIVITY INDEX (DI)</b>	8 dB +/- 2 dB 1.6 kHz - 20 kHz
<b>DIRECTIVITY FACTOR (Q)</b>	6.3
<b>NOMINAL IMPEDANCE</b>	8 ohms, minimum 5.1 ohms @ 112 Hz
<b>CROSSOVER FREQUENCY</b>	1 kHz
<b>COMPONENTS</b>	One K-48-ST 15" woofer One K-691 3" titanium compression driver on a K-510 horn
<b>INPUT CONNECTION</b>	Two point barrier strip
<b>MOUNTING OPTION</b>	Sixteen 3/8"-16 flypoints
<b>BRACKET MOUNT</b>	One attachment point for C-bracket Top and Bottom: 3/8"-16
<b>ENCLOSURE MATERIAL</b>	3/4" 7-ply birch plywood cabinet 1" MDF motorboard
<b>HEIGHT</b>	34.3" (87.12cm)
<b>WIDTH</b>	19.8" (50.29cm) front 6.8" (17.27cm) rear
<b>DEPTH</b>	16" (40.64cm)
<b>WEIGHT</b>	76 lbs. (34.54kg)
<b>FINISHES</b>	Black, White and Raw Birch finish

<sup>1</sup> 3M, Half-spaced anechoic

<sup>2</sup> AES standard, continuous pink noise, 6 dB peaks

<sup>3</sup> Calculated at 1M half-spaced at power handling power input

<sup>4</sup> SPL at 1M, half-spaced anechoic with 2.83V input

# KI-396-SMA-II

HIGH OUTPUT 15" 2-WAY LOUDSPEAKER



KLIPSCH PROFESSIONAL | PERMANENT INSTALLATION | DATA SHEET

## FREQUENCY RESPONSE

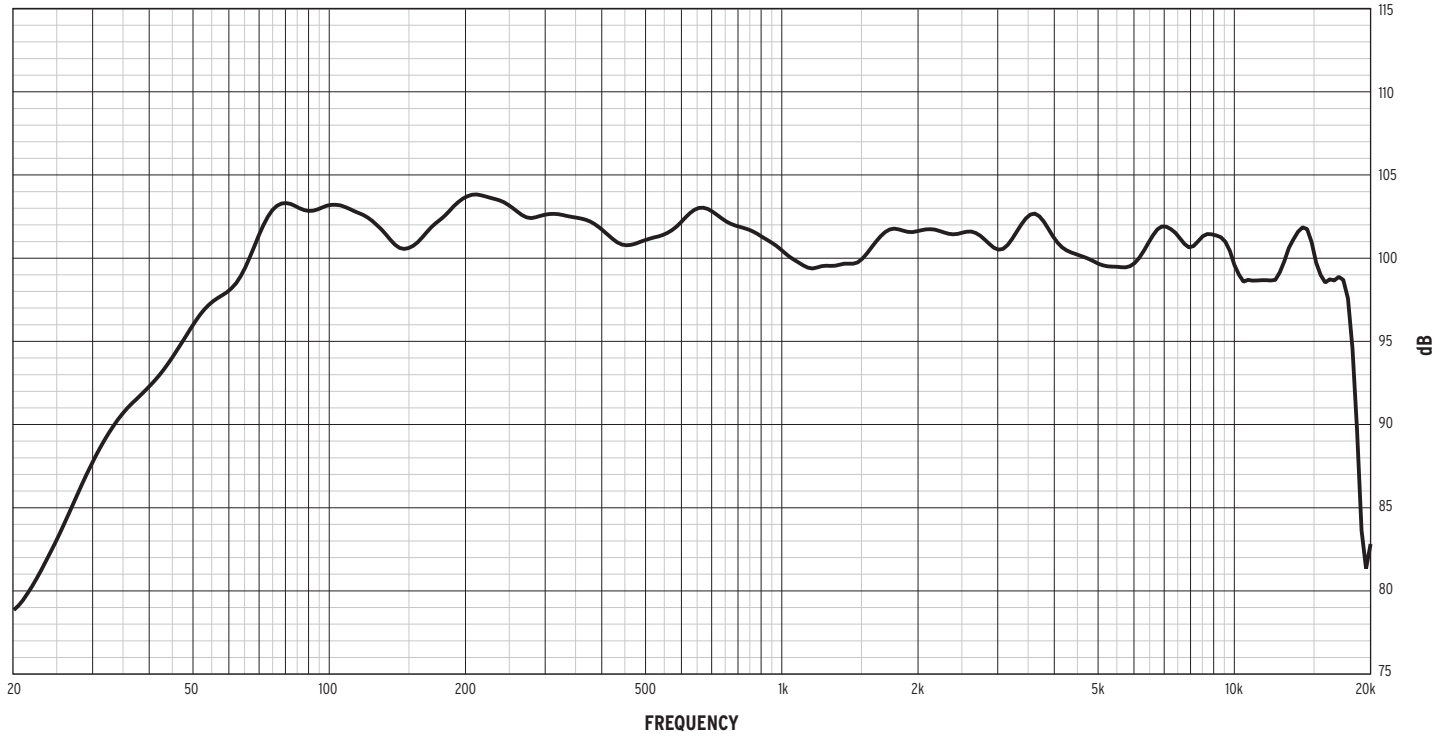

## IMPEDANCE

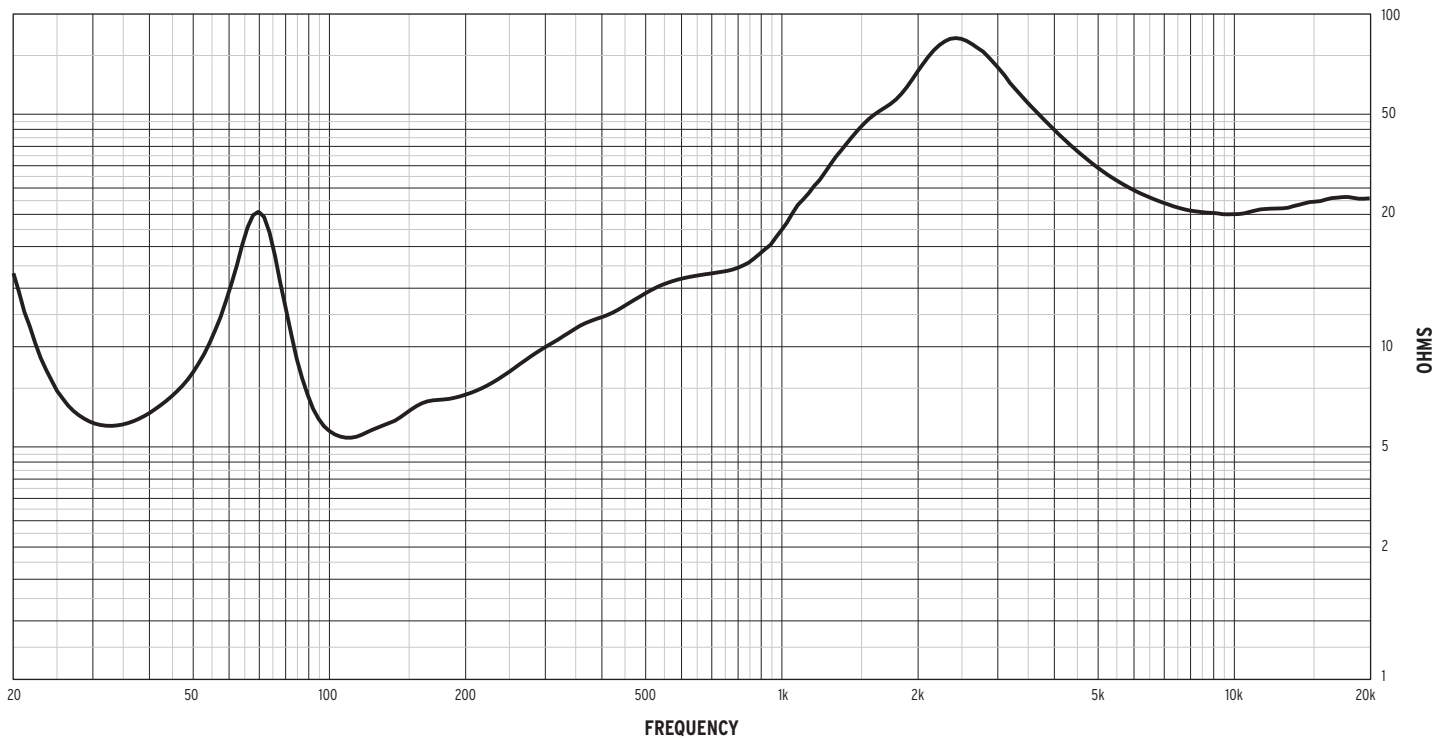

# KI-396-SMA-II

HIGH OUTPUT 15" 2-WAY LOUDSPEAKER



# Klipsch

KLIPSCH PROFESSIONAL | PERMANENT INSTALLATION | DATA SHEET

### HORIZONTAL OFF AXIS TRANSFER FUNCTION

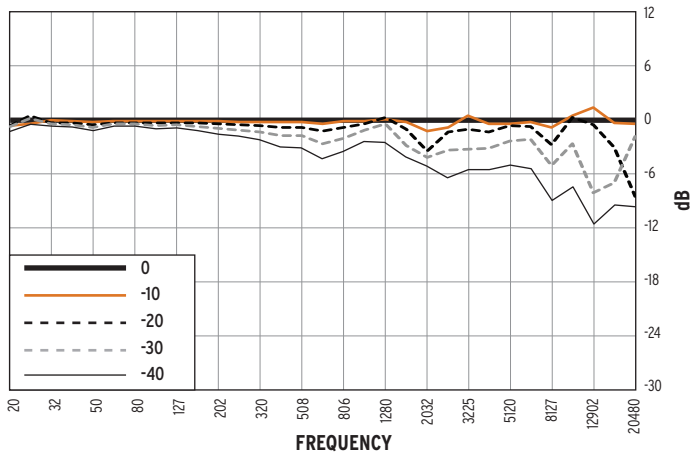

### HORIZONTAL COVERAGE (-6dB)

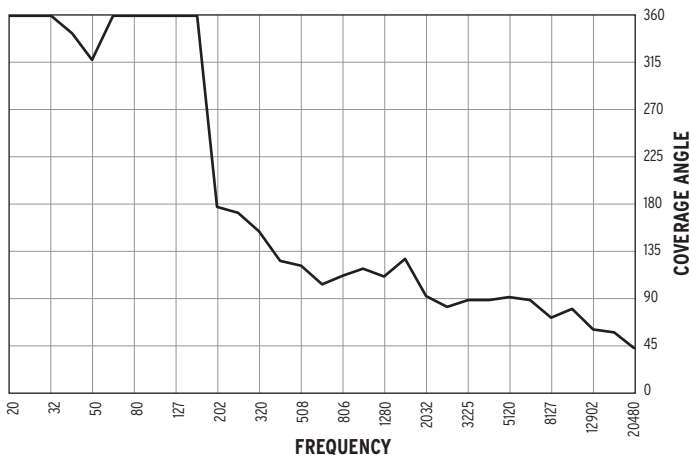

### VERTICAL OFF AXIS TRANSFER FUNCTION UP

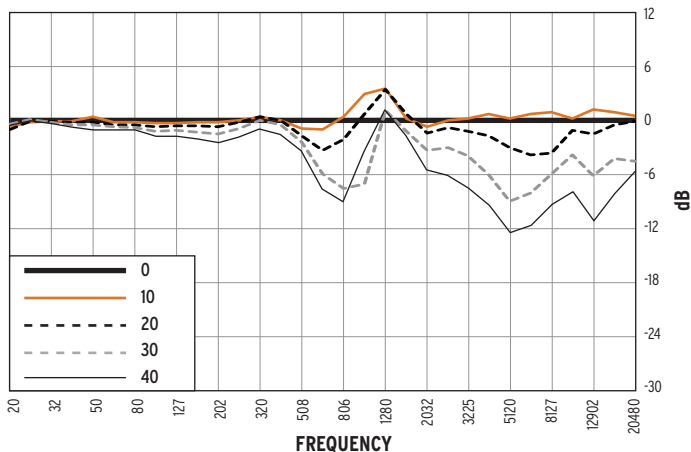

### VERTICAL COVERAGE (-6dB)

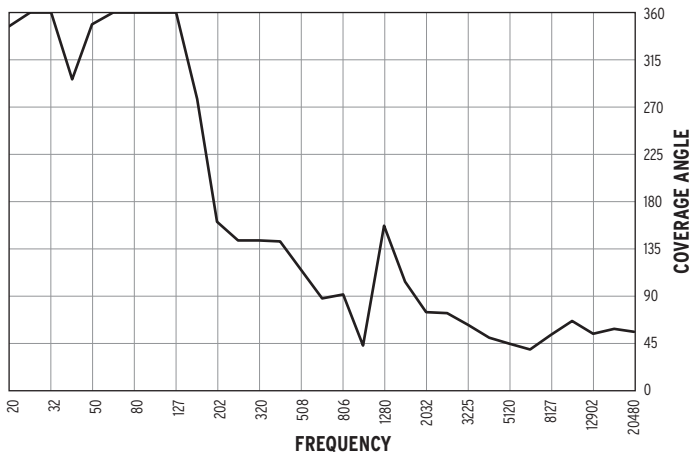

### VERTICAL OFF AXIS TRANSFER FUNCTION DOWN

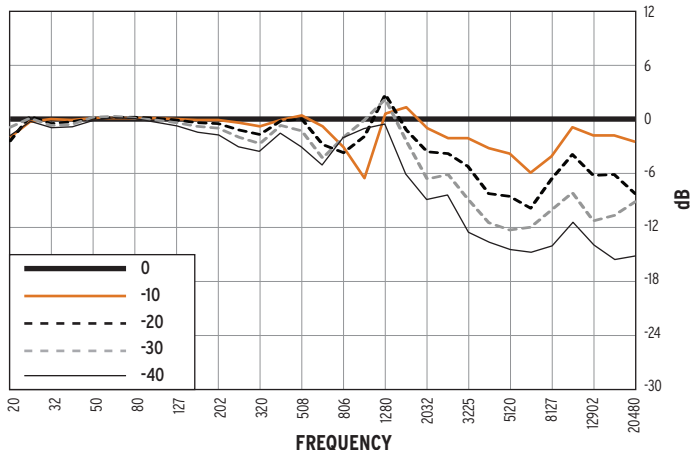

### DIRECTIVITY INDEX

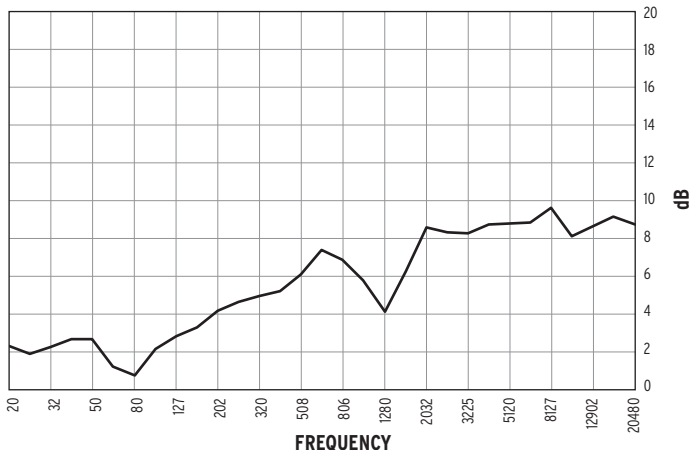

# KI-396-SMA-II

HIGH OUTPUT 15" 2-WAY LOUDSPEAKER



KLIPSCH PROFESSIONAL | PERMANENT INSTALLATION | DATA SHEET

## HORIZONTAL 1/3 OCTAVE POLARS

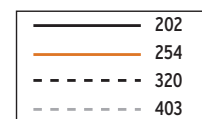
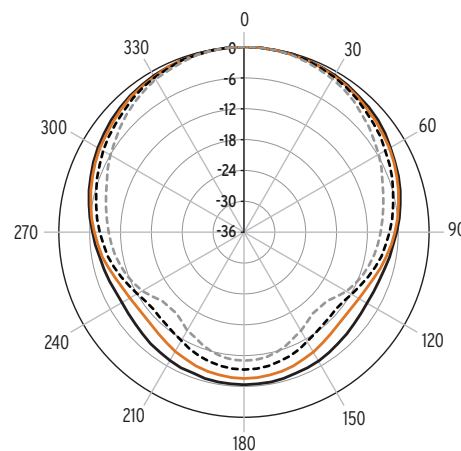
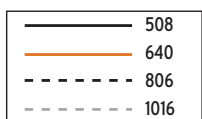
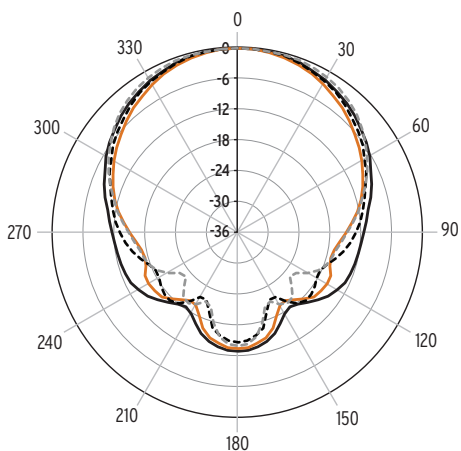
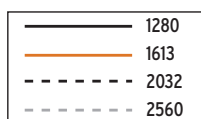
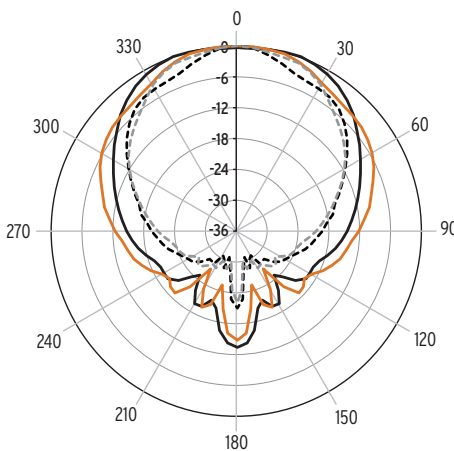
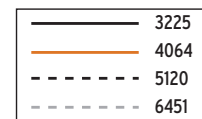
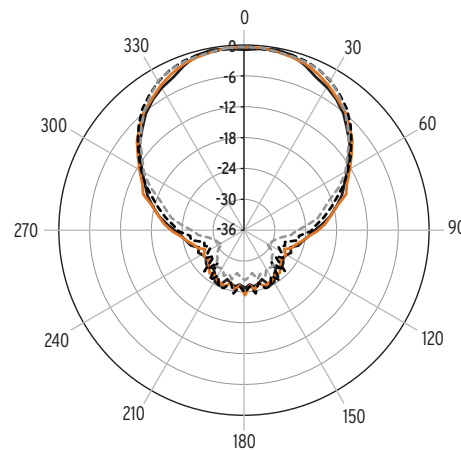
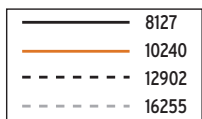
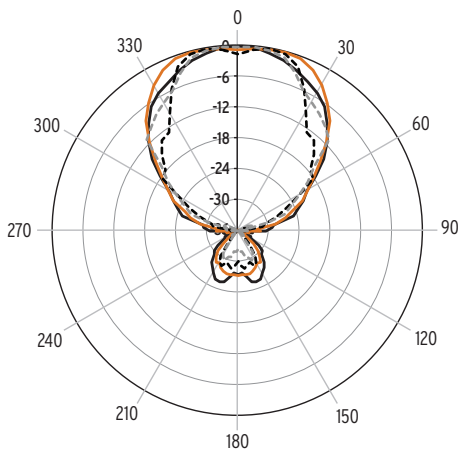



# KI-396-SMA-II

HIGH OUTPUT 15" 2-WAY LOUDSPEAKER



KLIPSCH PROFESSIONAL | PERMANENT INSTALLATION | DATA SHEET

## VERTICAL 1/3 OCTAVE POLARS

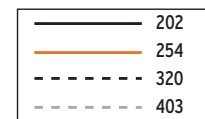
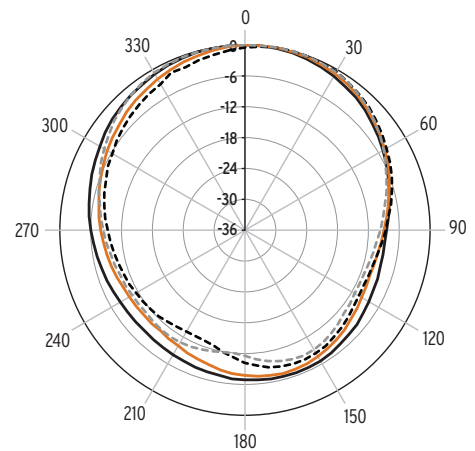
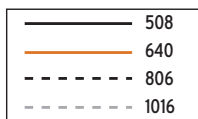
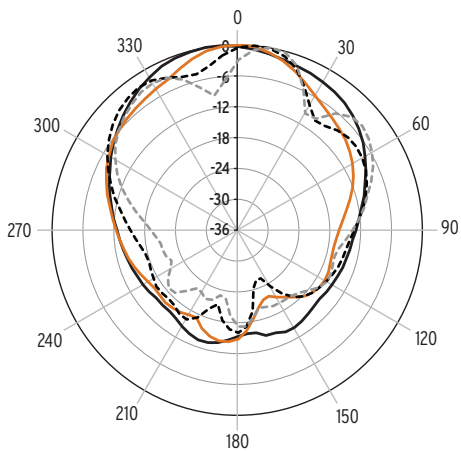
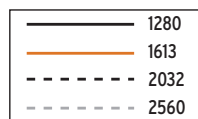
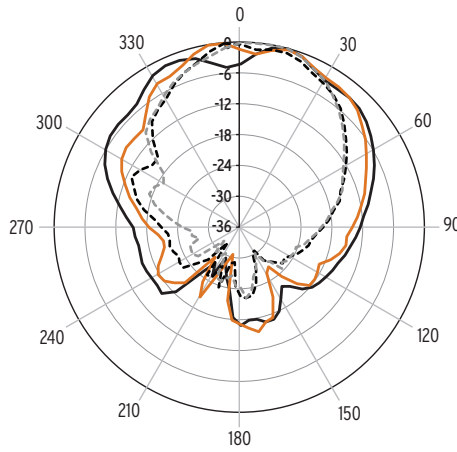
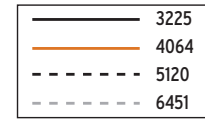
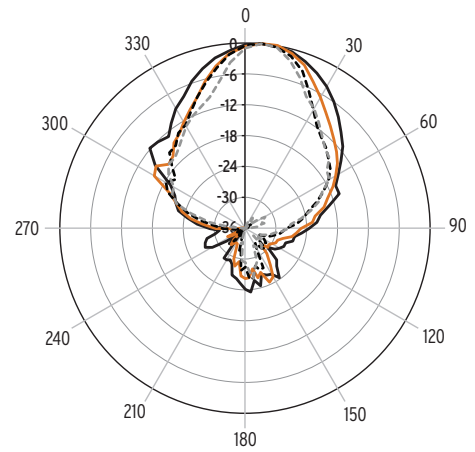
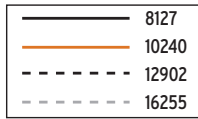
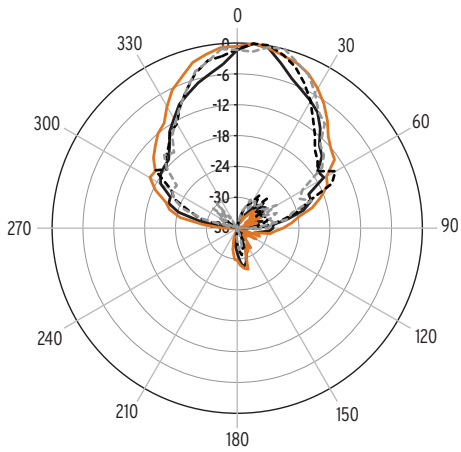

# KI-396-SMA-II

HIGH OUTPUT 15" 2-WAY LOUDSPEAKER



KLIPSCH PROFESSIONAL | PERMANENT INSTALLATION | DATA SHEET

## ARCHITECTURAL SPECIFICATIONS

The KI-396-SMA-II high power 15" three-way trapezoidal speaker system shall include a 15" (381mm) K-48-ST low-frequency transducer utilizing a 3" (76.2mm) voice coil, 104-ounce (2.95kg) magnet and motor magnet assembly, a High-frequency 3" (76.2mm) titanium diaphragm 64-ounce (1.82kg) magnet compression driver mounted on a 90° X 60° heavy-duty, injection molded modified Tractrix Horn. Signal shall be applied to the transducers via full-range internal frequency-dividing network. The enclosure tuning shall be of a vented design.

Frequency response shall be 60Hz to 18kHz, +/- 3dB, with the -10dB point at 35Hz, measured at three meters, half-space anechoic. The dispersion angle shall be 90° X 60° nominal. Directivity Index shall be 8dB. Sensitivity shall be 101dB SPL, measured at one meter, half-space anechoic, with a 2.83V input. Power handling shall be 600 watts (56 volts), to AES standards, continuous pink noise, 40Hz to 10kHz, 6dB peaks. Calculated maximum continuous output at one meter shall be 127dB SPL. Nominal impedance shall be 8 ohms, with 5.1 ohms minimum at 112Hz. The internal passive crossover frequencies shall be 1kHz, with slopes of 12dB/octave on the low frequency, and 18dB/octave on the high frequency. Signal connections shall be made via a two-point barrier strip.

The enclosure panels shall be CNC-fabricated, 3/4" 7-ply birch plywood, assembled using rabbet and dado joinery. The motorboard baffle shall be 1" (2.54cm) medium density fiberboard. Dimensions for the enclosure shall be 34.3" (87.12cm) high by 16.0" (40.64cm) deep by 19.8" (50.29cm) front width and 6.8" (17.27cm) rear width in a symmetrical trapezoidal shape, with both side panels angled at 22.5°. Net weight shall be 76 lbs. (34.55kg). The enclosure will have a straight metal perforated grille for structural integrity and protection of the transducers from impact and tampering. Enclosure flying capability shall be provided via sixteen internal 3/8" 16-thread mounting points, four per top, bottom and both sides.

Enclosure bracket mounting is provided with one 3/8"-16 threaded mount point on top and bottom panels.

The enclosure shall be coated with lacquer-based primer and lacquer-based texture, with a black or white finish. The enclosure shall also be available unfinished in raw birch.

The system shall be a Klipsch KI-396-SMA-II loudspeaker.

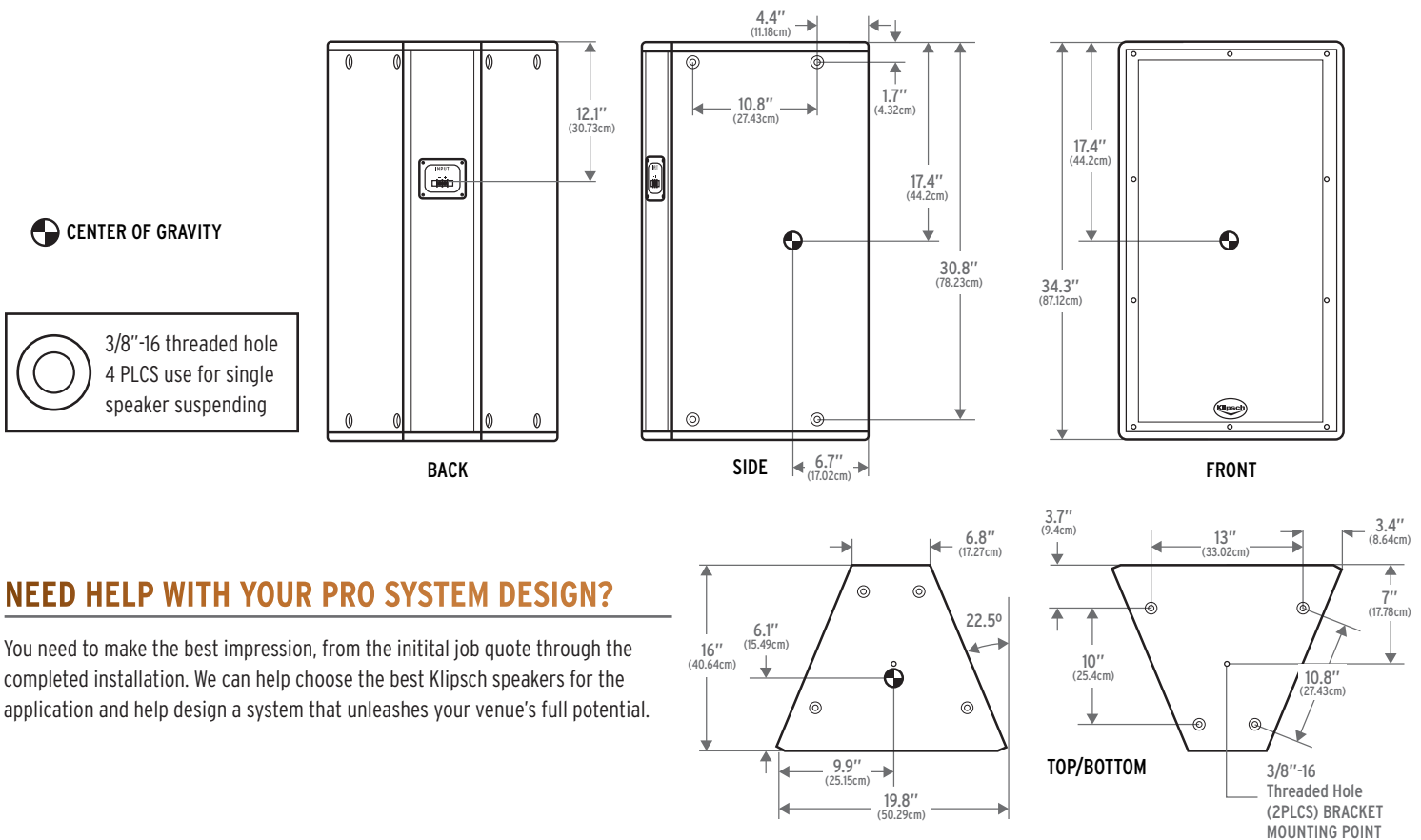

## NEED HELP WITH YOUR PRO SYSTEM DESIGN?

You need to make the best impression, from the initial job quote through the completed installation. We can help choose the best Klipsch speakers for the application and help design a system that unleashes your venue's full potential.

# KI-396-SMA-II

HIGH OUTPUT 15" 2-WAY LOUDSPEAKER



KLIPSCH PROFESSIONAL | PERMANENT INSTALLATION | DATA SHEET

## ORDERING INFORMATION

### KI-396-SMA-II

PART NUMBER	MODEL NAME	FINISH	PACKED QUANTITY	DESCRIPTION	UPC
1062027	KI-396-B-SMA-II	Black	1	Standard 8 ohm speaker	743878028003
1062028	KI-396-W-SMA-II	White	1	Standard 8 ohm speaker	743878029116
1062029	KI-396-R-SMA-II	Raw Birch	1	Standard 8 ohm speaker	743878029109

### KI-396-SMA-II CARTON DIMENSIONS

HEIGHT	37" (94.0 cm)
WIDTH	22" (55.8 cm)
DEPTH	18.9" (48.0 cm)