

# KI-102-SMA-II

COMPACT TRAPEZOIDAL 8" 2-WAY LOUDSPEAKER



# Klipsch

KLIPSCH PROFESSIONAL | PERMANENT INSTALLATION | DATA SHEET



## PRODUCT OVERVIEW

The KI-102-SMA-II is a horn-loaded, two-way trapezoidal loudspeaker system capable of superb voice and music performance in permanent limited-space installations. It is recommended for use in restaurants, clubs, schools, houses of worship, health clubs, and corporate A/V production environments where fidelity requirements are high but real estate is limited.

The enclosure is constructed using CNC fabrication techniques, dado "lock-tab" and rabbet-joint construction. This contributes to industry leading reliability, maximum precision and ruggedness, and a cabinet remarkably free from resonance and cabinet-induced coloration. Mounting capabilities include top and bottom attachments for the optional SB-102 Mounting "U"-shaped bracket.

## FEATURES

- Compact 22.5° symmetrical trapezoidal design
- 115dB maximum continuous output
- 8" woofer and 1" titanium diaphragm high-frequency compression driver
- 90° X 90° modified Tractrix Horn
- KLIP-circuit HF driver protection devices
- Top/Bottom attachments for optional Klipsch SB-102 U-shaped bracket
- Available in Black, White or Raw MDF finish

## APPLICATIONS

- Restaurants
- Schools
- Houses of worship
- Health clubs
- AV production environments
- Auditoriums

## ALSO AVAILABLE

**KI-102-T-SMA-II**  
60W / 70 Volt Transformer Version

## DESIGNED AND MADE IN THE USA

USING DOMESTIC AND IMPORTED COMPONENTS

In 1946, Paul W Klipsch, genius & maverick, hand-built his first loudspeaker in a tin shed with the intention of bringing live music into his living room. Remember great sound? We do, too. Today, Klipsch's KI series speaker enclosures are made in the USA, by proud craftsmen in Hope, Arkansas. Just like PWK intended.

## SPECIFICATIONS

<b>FREQUENCY RESPONSE<sup>1</sup></b> (+/- 3 dB)	88 Hz - 17 kHz (-10 dB @ 56 Hz)
<b>POWER HANDLING<sup>2</sup></b>	200 watts (31V) 800 watts peak
<b>MAXIMUM SPL<sup>3</sup></b>	115 dB Continuous 121 dB Peak
<b>SENSITIVITY<sup>4</sup></b>	95 dB
<b>COVERAGE</b>	Horizontal: 90° +/- 20° 2.1 kHz - 19 kHz Vertical: 90° +/- 30° 2.5 kHz - 19 kHz
<b>DIRECTIVITY INDEX (DI)</b>	7 dB +/- 1 dB 1 kHz - 17 kHz
<b>DIRECTIVITY FACTOR (Q)</b>	5
<b>NOMINAL IMPEDANCE</b>	8 ohms, minimum 4.9 ohms @ 184 Hz
<b>OVERLOAD PROTECTION</b>	KLIP Overload Protection Circuit-HF
<b>CROSSOVER FREQUENCY</b>	2 kHz
<b>COMPONENTS</b>	One K-81-ST 8" woofer One K-103-TI-KP 1" titanium compression driver on a K-802-M horn
<b>INPUT CONNECTION</b>	Two point barrier strip
<b>MOUNTING OPTIONS</b>	2 screw: 1/4" x 20 Machine screw for SB-102 Bracket
<b>ENCLOSURE MATERIAL</b>	3/4" MDF
<b>HEIGHT</b>	18.9" (48.00cm)
<b>WIDTH</b>	11.6" (29.46cm) front 4.2" (10.67cm) rear
<b>DEPTH</b>	9.3" (23.77cm)
<b>WEIGHT</b>	24 lbs. (10.90kg)
<b>FINISHES</b>	Black, White and Raw MDF
<b>ACCESSORIES</b>	SB-102 Mounting Bracket

## WITH SB-102 MOUNTING BRACKET



<sup>1</sup> 3M, Half-spaced anechoic  
<sup>2</sup> AES standard, continuous pink noise, 6 dB peaks  
<sup>3</sup> Calculated at 1M half-spaced at power handling power input  
<sup>4</sup> SPL at 1M, half-spaced anechoic with 2.83V input

# KI-102-SMA-II

COMPACT TRAPEZOIDAL 8" 2-WAY LOUDSPEAKER



KLIPSCH PROFESSIONAL | PERMANENT INSTALLATION | DATA SHEET

## FREQUENCY RESPONSE

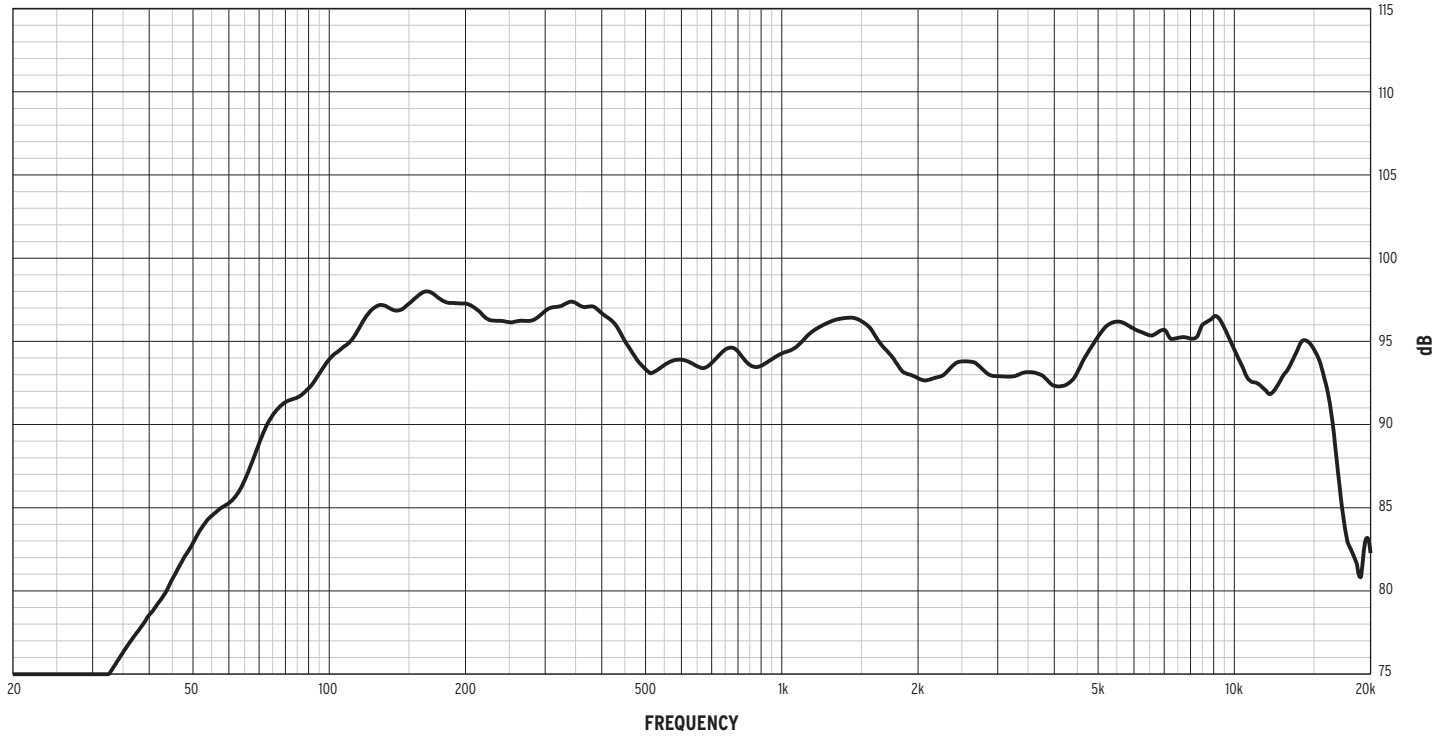

## IMPEDANCE

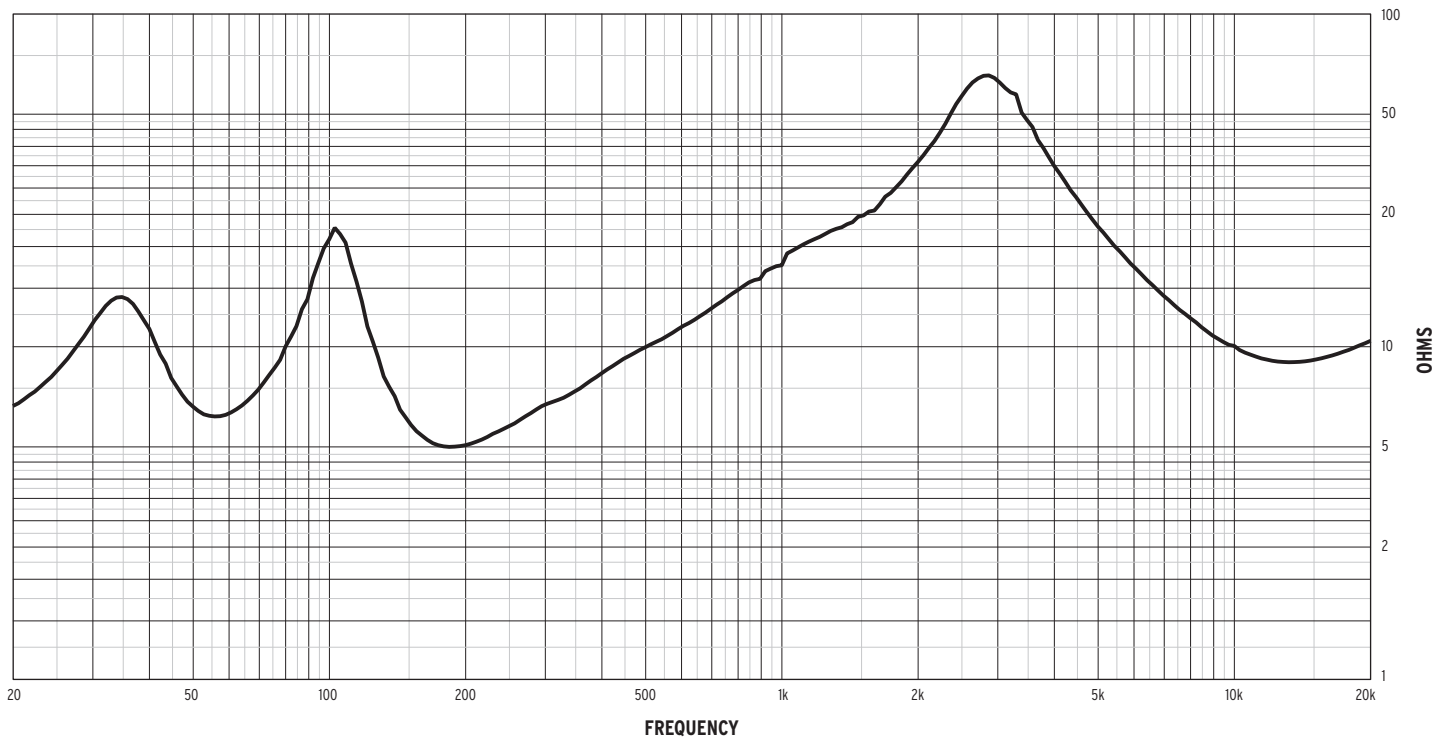

# KI-102-SMA-II

COMPACT TRAPEZOIDAL 8" 2-WAY LOUDSPEAKER



KLIPSCH PROFESSIONAL | PERMANENT INSTALLATION | DATA SHEET

### HORIZONTAL OFF AXIS TRANSFER FUNCTION

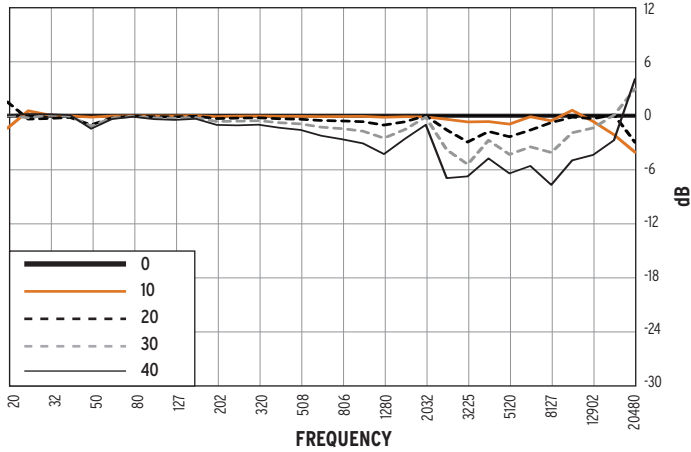

### HORIZONTAL COVERAGE (-6dB)

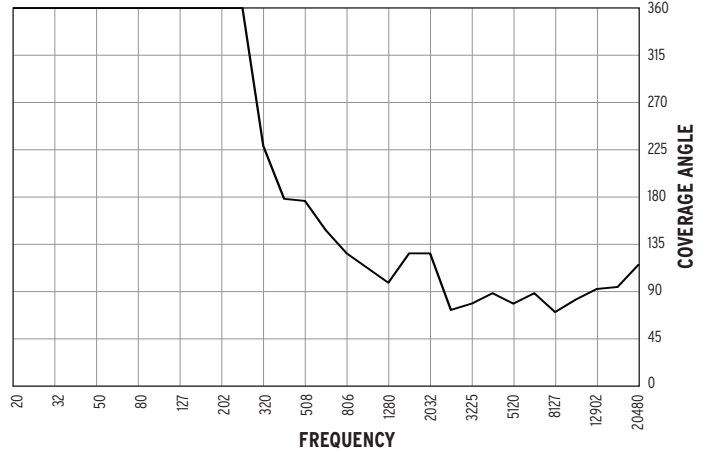

### VERTICAL OFF AXIS TRANSFER FUNCTION UP

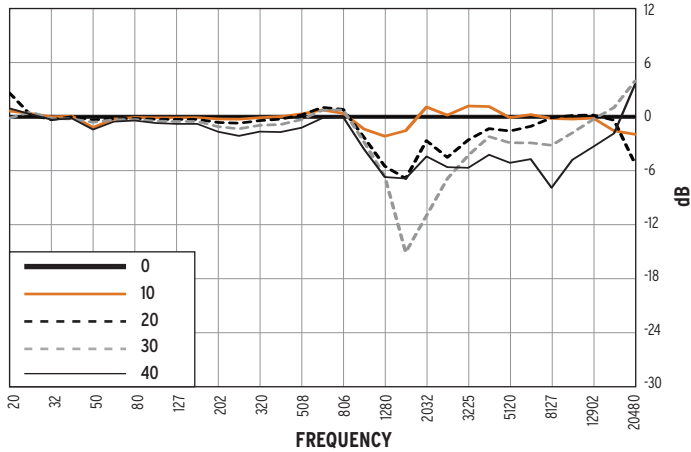

### VERTICAL COVERAGE (-6dB)

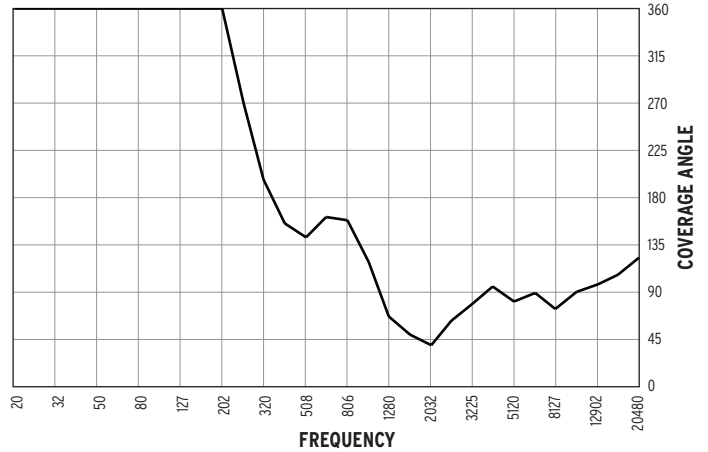

### VERTICAL OFF AXIS TRANSFER FUNCTION DOWN

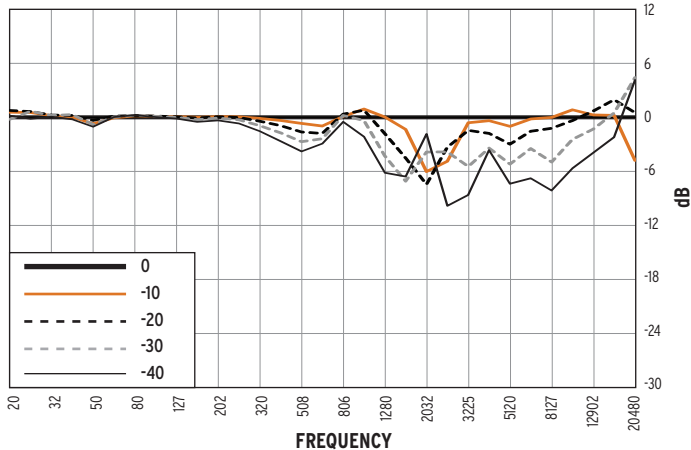

### DIRECTIVITY INDEX

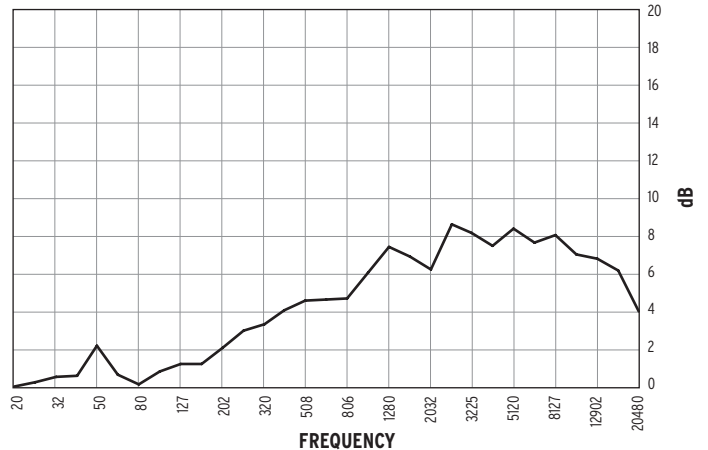

# KI-102-SMA-II

COMPACT TRAPEZOIDAL 8" 2-WAY LOUDSPEAKER



# Klipsch

KLIPSCH PROFESSIONAL | PERMANENT INSTALLATION | DATA SHEET

## HORIZONTAL 1/3 OCTAVE POLARS

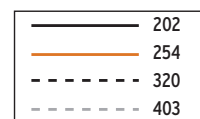
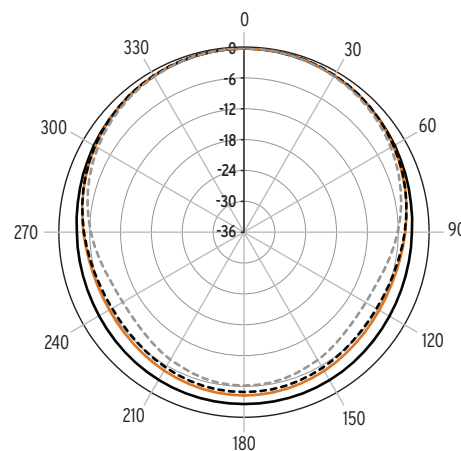
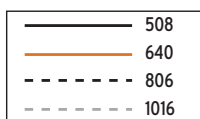
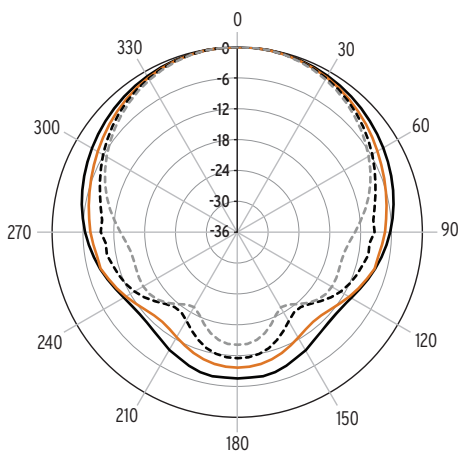
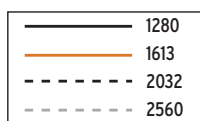
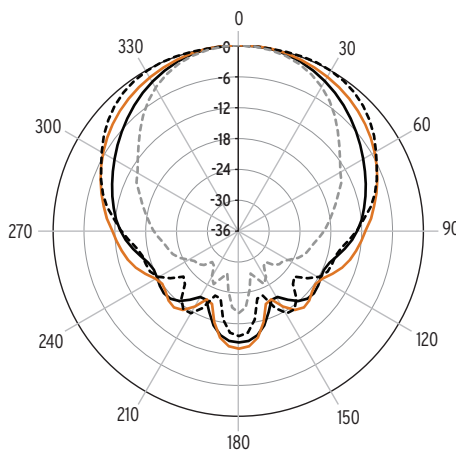
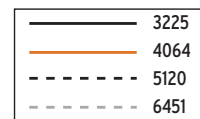
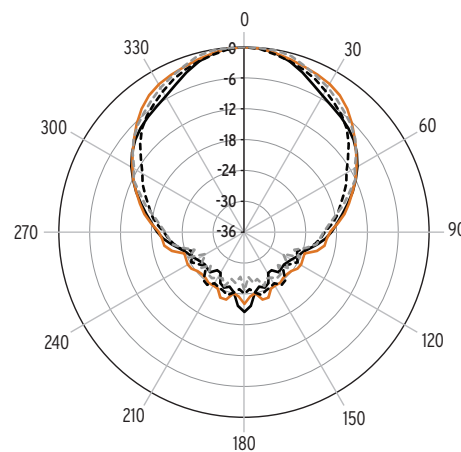
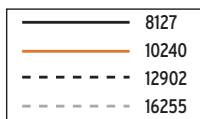
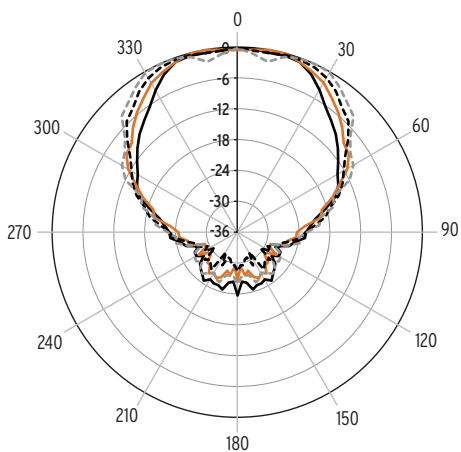



# KI-102-SMA-II

COMPACT TRAPEZOIDAL 8" 2-WAY LOUDSPEAKER



KLIPSCH PROFESSIONAL | PERMANENT INSTALLATION | DATA SHEET

## VERTICAL 1/3 OCTAVE POLARS

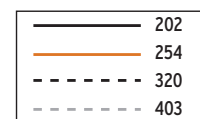
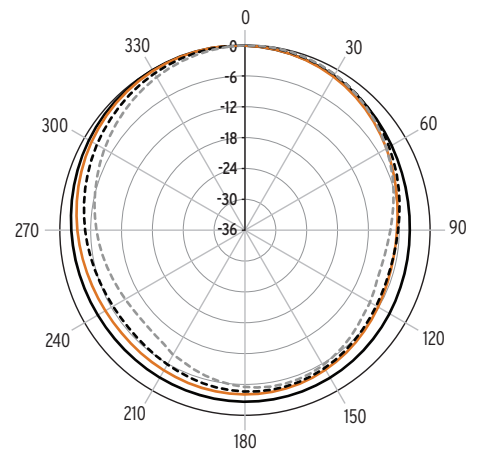
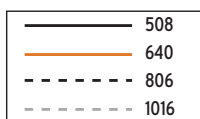
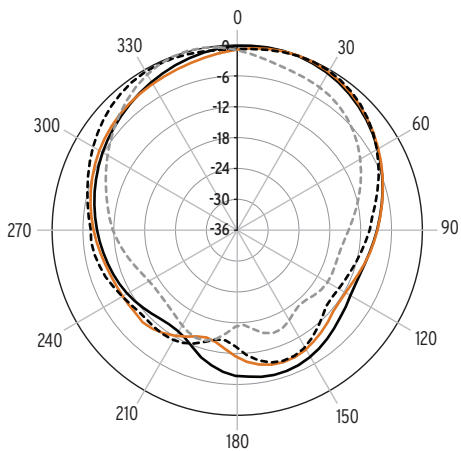
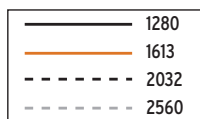
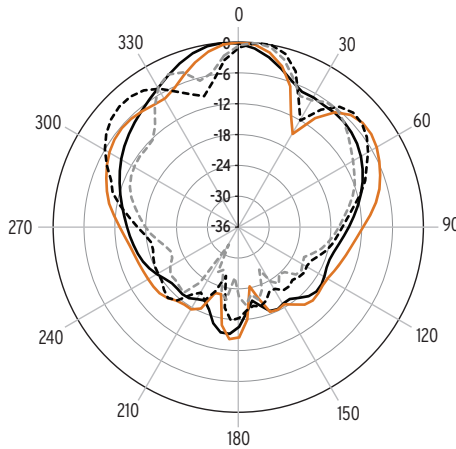
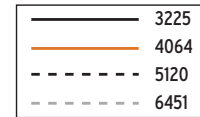
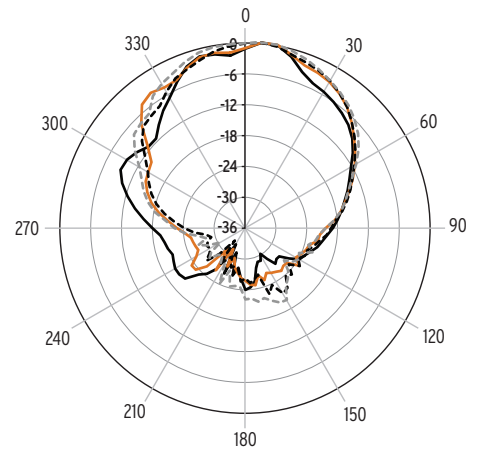
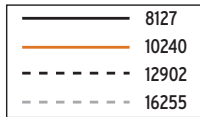
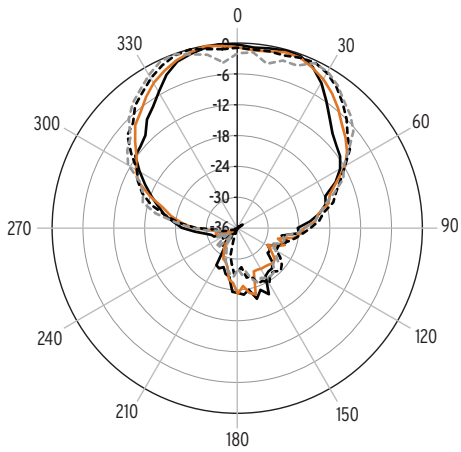

# KI-102-SMA-II

COMPACT TRAPEZOIDAL 8" 2-WAY LOUDSPEAKER



KLIPSCH PROFESSIONAL | PERMANENT INSTALLATION | DATA SHEET

## ARCHITECTURAL SPECIFICATIONS

The KI-102-SMA-II compact high power loudspeaker system shall include an 8" (203.2mm) K-81-ST low-frequency transducer utilizing a 2" (50.8mm) diameter voice coil, 30-ounce (850.5g) magnet and motor magnet assembly and a K-103-TI-KP 1" (25.4mm) titanium diaphragm high-frequency 4.7-ounce (133.2g) magnet compression driver mounted on a 90° X 90°, heavy duty, injected molded, modified Tractrix Horn. Signal shall be applied to the transducers via a passive internal frequency-dividing network, incorporating a KLIP-circuit for signal overload protection of the high frequency transducer. The enclosure tuning shall be of a vented design.

Frequency response shall be 88Hz to 17kHz, +/- 3dB, with the -10dBpoint at 56Hz, measured at three meters, half-space anechoic. The dispersion angle shall be 90° X 90° nominal. Directivity Index shall be 7dB. Sensitivity shall be 95dB SPL, measured at one meter, half-space anechoic, with a 2.83V input. Power handling shall be 200 watts (31 volts), to AES standards, continuous pink noise, 60Hz to 10kHz, 6dB peaks. Calculated maximum continuous output at one meter shall be 115dB SPL. Nominal impedance shall be 8 ohms, with 4.9 ohms minimum at 184Hz. The internal passive crossover frequency shall be 2kHz with a slope of 12dB/octave on the low frequency and 18dB/octave on the high- frequency. Signal connections shall be made via a two point barrier strip.

The enclosure panels shall be CNC-fabricated, 3/4" MDF, assembled utilizing rabbet and dado joinery. Dimensions for the enclosure shall be 18.9" (48.0cm) high by 9.3" (23.77cm) deep by 11.6" (29.46cm) front width and 4.2" (10.67cm) rear width in a symmetrical trapezoid shape, with both side panels angled at 22.5 degrees. Net weight shall be 24lbs (10.90kg).

A flat metal perforated grille on the cabinet front is for structural integrity and protection of the transducers from impact and tampering.

Enclosure mounting shall be via internal top and bottom 3/4"-20 T-nuts for the accessory Klipsch SB-102 "C"-shaped bracket. The enclosure shall be coated with lacquer-based primer and lacquer-based texture, with a black or white finish. The enclosure shall also be available unfinished in raw MDF.

The system shall be a Klipsch KI-102-SMA-II loudspeaker.

## NEED HELP WITH YOUR PRO SYSTEM DESIGN?

You need to make the best impression, from the initial job quote through the completed installation. We can help choose the best Klipsch speakers for the application and help design a system that unleashes your venue's full potential.

Send us you plans or questions to us at:

**PROSYSTEMDESIGN@KLIPSCH.COM**

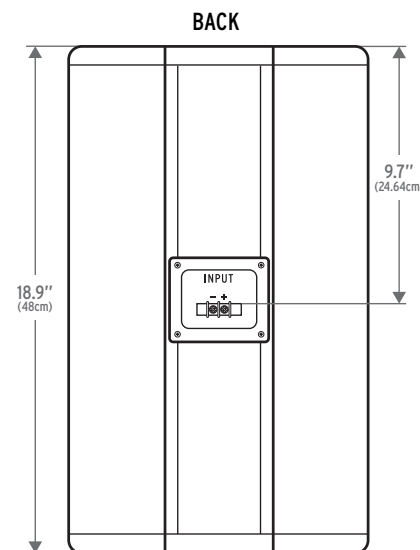
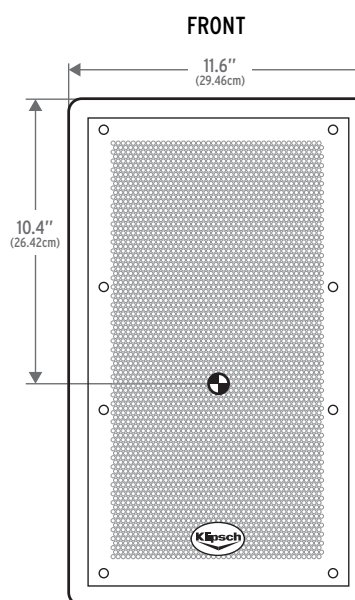
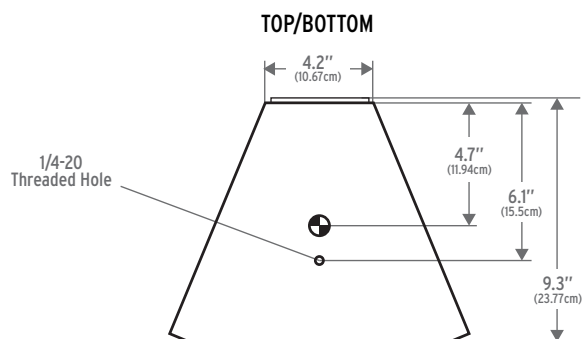

CENTER OF GRAVITY

# KI-102-SMA-II

COMPACT TRAPEZOIDAL 8" 2-WAY LOUDSPEAKER



KLIPSCH PROFESSIONAL | PERMANENT INSTALLATION | DATA SHEET

## KI-102-SMA-II

PART NUMBER	MODEL NAME	FINISH	PACKED QUANTITY	DESCRIPTION	UPC
1061960	KI-102-B-SMA-II	Black	1	Standard 8 ohm speaker	743878027921
1061961	KI-102-W-SMA-II	White	1	Standard 8 ohm speaker	743878029147
1061962	KI-102-R-SMA-II	Raw MDF	1	Standard 8 ohm speaker	743878029123

## KI-102-T-SMA-II

PART NUMBER	MODEL NAME	FINISH	PACKED QUANTITY	DESCRIPTION	UPC
1062000	KI-102-BT-SMA-II	Black	1	Standard 8 ohm speaker 60W / 70V Transformer	743878027938
1062006	KI-102-WT-SMA-II	White	1	Standard 8 ohm speaker 60W / 70V Transformer	743878029154
1062007	KI-102-RT-SMA-II	Raw MDF	1	Standard 8 ohm speaker 60W / 70V Transformer	743878029130

## SB-102 BRACKET

PART NUMBER	MODEL NAME	FINISH	PACKED QUANTITY	DESCRIPTION	UPC
1062964	SB-102	Black	1	U-Bracket for all KI-102-SMA-II models	743878030006
1062951	SB-102	White	1		743878030013

## KI-102-SMA-II CARTON DIMENSIONS

HEIGHT	20.9" (53.09cm)
WIDTH	13" (33.02cm)
DEPTH	13" (33.02cm)

## KI-102-T-SMA-II CARTON DIMENSIONS

HEIGHT	20.9" (53.09cm)
WIDTH	13" (33.02cm)
DEPTH	13" (33.02cm)

## SB-102 CARTON DIMENSIONS

HEIGHT	2.75" (7cm)
WIDTH	8.7" (22.1cm)
DEPTH	19.7" (50cm)
WEIGHT	2 lbs. (0.91kg)

ORDERING INFORMATION