

Crosby®



The cover features a central image of a computer monitor displaying the Straightpoint software interface. The interface shows three load cell data points: [Loadcell 1] at 0.826 te, [Loadcell 2] at 1.652 te, and [Loadcell 3] at 5.826 te. Each data point includes a 'Gross' label and four status indicators: 'Low', 'High 1', and 'High 2'. A yellow and blue wireless transmitter device is overlaid on the screen. The device has a blue top and a yellow bottom with a blue 'SP' logo and signal waves. Text on the device includes 'www.straightpoint.com', 'CORRECT THIS PAGE FOR YOUR LOAD CELL', 'CONTAINS FCC ID: W740A97312400000', 'CONTAINS FCC ID: W740A97312400000', and 'MODEL: SW-0'. Below the screen, the text 'INSIGHT™' is written in white on a blue background, followed by a small UK flag icon and the text 'Operating instructions'.

INSIGHT user manual

v2.00
Part No:
SU6045



PLEASE NOTE THAT CROSBY/STRAIGHTPOINT ACCEPT NO RESPONSIBILITY FOR ANY ERRORS OR OMISSIONS WITHIN THIS MANUAL.

Before Use	5
Overview	5
Prerequisites	5
Computer System Requirements	5
Installation	5
USB Dongle	6
Running INSIGHT	7
Activating INSIGHT	8
Configuring Load Cells	9-10
Setting up a Project	11-12
Project Name and description	11
Units	11
Logging Type (<i>select option from the drop down list</i>)	12
Logging Interval (<i>ms</i>)	12
Logging Directory	12
RF Channel and Security Key	12
Overload %	12
Project Load Cells	13-17
Edit Project Load Cell	13
Load Cell Serial Number	14
Formula	14
Description	15
Alarm Settings	15-16
Advanced Settings	16
Load Cell Displays	18-19
Load Cell Display Icons	20
Load Cell Charts	21
Visualisations	22
Reports	23-24

Centre of Gravity (CoG)	25-27
Proof Test Plus (PTP)	28
PTP Set-up	29-34
Set-up	29
Set up engineers	30
Select load cells	31-32
Set up customer	33
Set up load test	34
Using the System	35-38
Testing	35-36
Test Reports/Certificates	37-38
Data Logging	39
Logged Data File format	39
Backup and Restore Functions	39
Appendix A	40
Glossary of Icons	41
Glossary	42
Notes	43

Before Use

Overview

The functions of the INSIGHT software package are as follows:

- To act in a similar capacity to a hand held display.
- To chart, log and report load cell data readings.
- To produce and display a visualisation of the working set-up.
- To calculate and produce Centre of Gravity (COG) Reports.
- To do proof testing and generate certificates where traceability and documentary evidence is required of load verification and proof testing.

Prerequisites

To use the INSIGHT Software, you will require a USB dongle (SW-D) and at least one TS load cell.

Computer system requirements

- Processor: 3 gigahertz (GHz) or faster
RAM: 4 GB
With .NET 4.5.2 or above (should be automatically installed)
- Windows® 7, Windows® 8 or Windows® 10
(must have English language option selected)
- Spare USB port (not hub)

Installation

To start, either:

Scan the QR code found on the card that accompanies the SW-D USB dongle to download software to your phone and then, when the download is complete, transfer the file to your PC online or offline.

or

Type in the weblink address into your web browser's address bar to download software directly to your PC.
www.straightpoint.com/software/insight.zip

Once the download has completed, please double click on the downloaded file and the software should auto install.

Your version of Windows may inform you that this INSIGHT Software may harm your PC and ask permission to install it, in which case take the path to install the software.

IMPORTANT NOTE:

If you are installing software onto **Windows 10**, please go to this user guide's 'Appendix A' (page 41) and read the advice provided.

USB Dongle

Plug the USB dongle into the PC, no driver needs to be installed.



To achieve a better line of sight between the USB dongle and the load cell you can attach it to a sports/action camera (e.g. Go-pro) mount and clamp kit.

You can then connect dongle to PC via a USB extension cable.

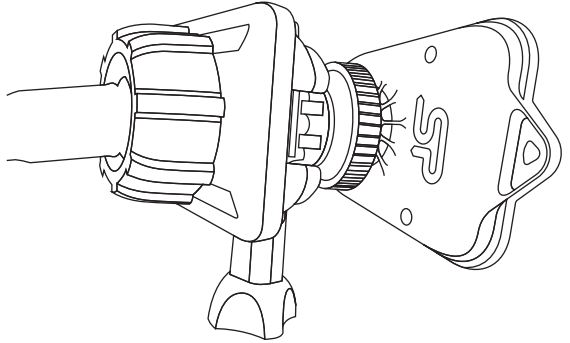

Setup dongle with mount kit so that direct line of sight between the dongle and the load cell is achieved.

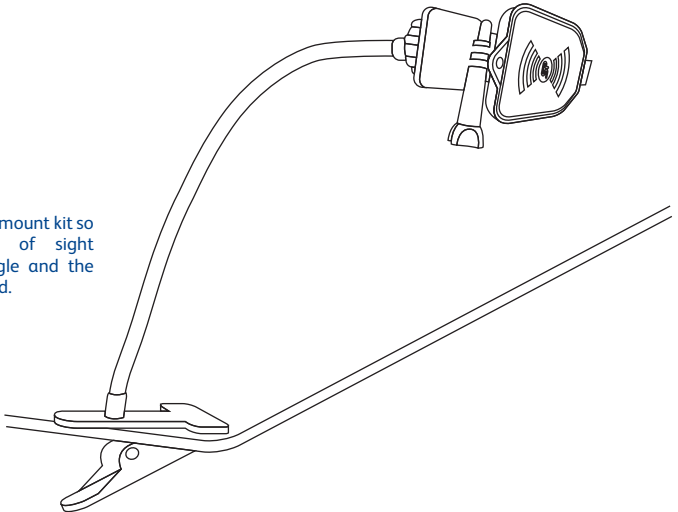

Running INSIGHT



Either locate the INSIGHT icon or type 'INSIGHT' into the Windows search bar and then double click on the INSIGHT icon to run it.

The following screen should appear briefly (see below).
If INSIGHT needs to be activated, see 'Activating INSIGHT' on page 8.



The screen above is then followed by:

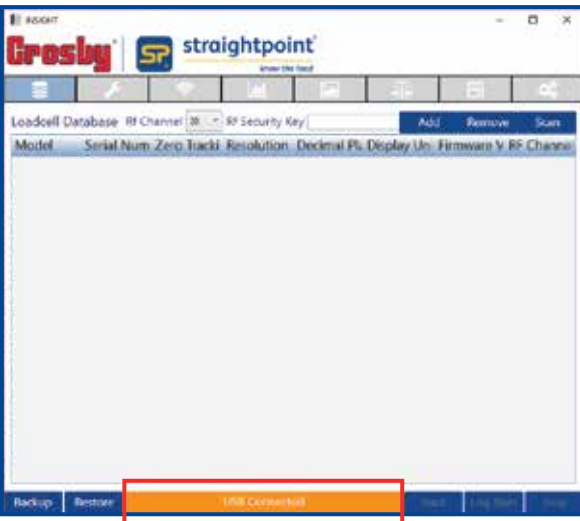

Note: If the USB dongle has been correctly inserted, the screen should show 'USB Connected' in amber at the bottom.

Activating INSIGHT

IMPORTANT: In order to run INSIGHT, it needs to be activated.

When the following screen appears (see below), contact Crosby | Straightpoint via email quoting the unique ID (in this case EAFEF87C), dongle model number and serial number to:

activate@straightpoint.com

You will then receive an email reply containing the text you will need to enter into the 'Activation Code' field. Once you have entered the code correctly, the message will disappear, giving you full functionality of the software.

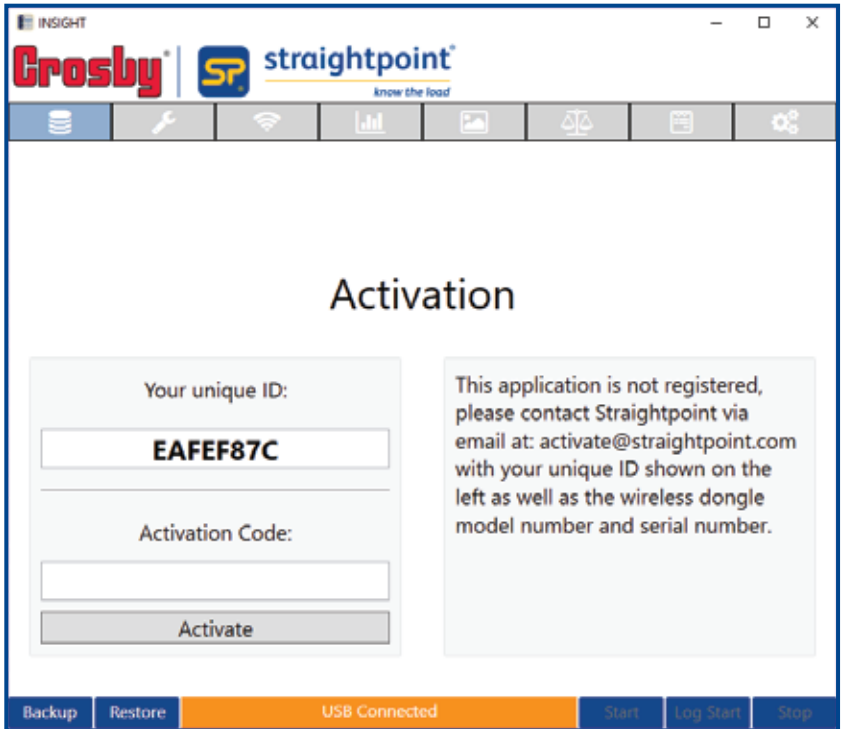

Configuring Load Cells

Before the functionality and features of INSIGHT can be used, a data base of load cells needs to be created in order to make them available for the software to use.

You must have at least one Crosby | Straightpoint TS load cells available for use.

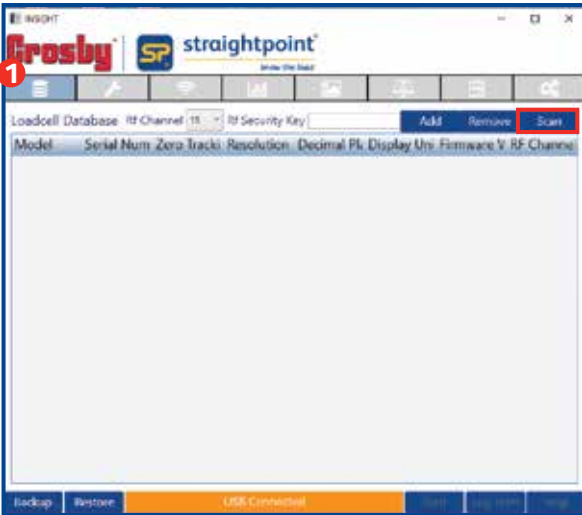

1



Select the Load Cell data base icon in the top left corner of the INSIGHT screen.

Assuming your load cell(s) are powered on (batteries are inserted), select the 'Scan' button towards the top right-hand corner (highlighted above).

If your RF channel or Security key is different to that displayed in the 'RF Channel' dropdown options, these will need to be correctly set before the scan can start. If they are not set to the correct channel or key, your load cell will not be displayed. Default load cell channel is 15.

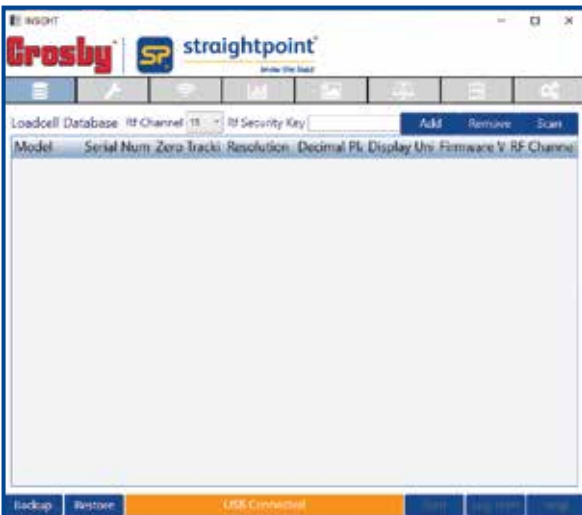

Configuring Load Cells (contd.)

Once the scan is initiated, the load cells that are available will appear in the load cell data base window within a minute.

Once the load cells have appeared in the window, select the 'Stop' button (highlighted below) to terminate the scan.

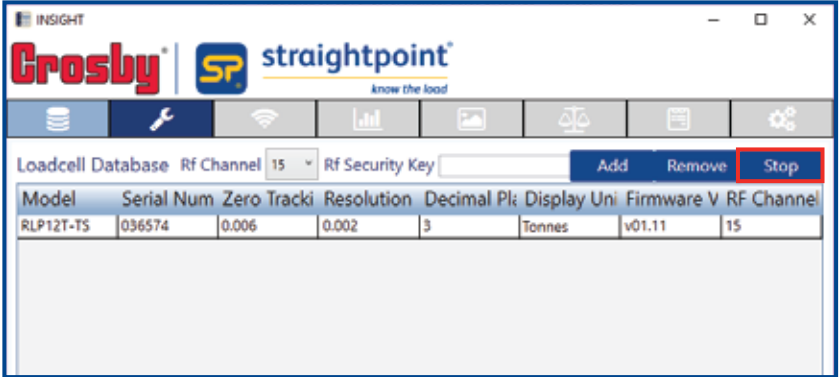

If you do not click the 'Stop' button you will not be able to edit any other item.

To highlight any entry, please click on it. If you would like to remove any load cell from the data base, please highlight it and then select the 'Remove' button.

If the load cells are not showing, they can be added manually by selecting the 'Add' button. To do so, select the new blank entry and add information for every field, apart from the version number. The data will be automatically saved and the 'Saved load cell' message will appear while you type in the information.

You can go back to the load cell data base option and add further load cells, if need be.

You should now have added the load cell(s) you require to the data base and can now explore the other functionalities of the INsIGHT software.

Setting up a Project

Once the load cell database has been populated, the next stage is to create a project. This needs to be performed before accessing any other functionality such as load cell data display, COG (Centre Of Gravity) calculation or Proof Test Plus. Creating a project assigns one or more of the load cells from the load cell database to the project.

If the project already exists, then you can select the 'Projects' folder (shown below) and then select 'Project' folder symbol to display a list of projects in a window; you can then select one project by clicking on it. The project details can then be edited if required.

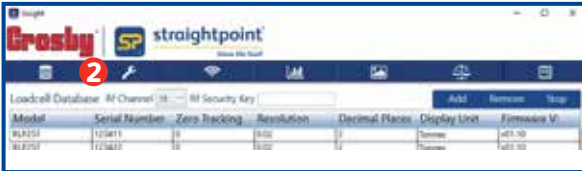

2



To start a new project click, '+New' (highlighted below) — this must be done before any data fields are entered.

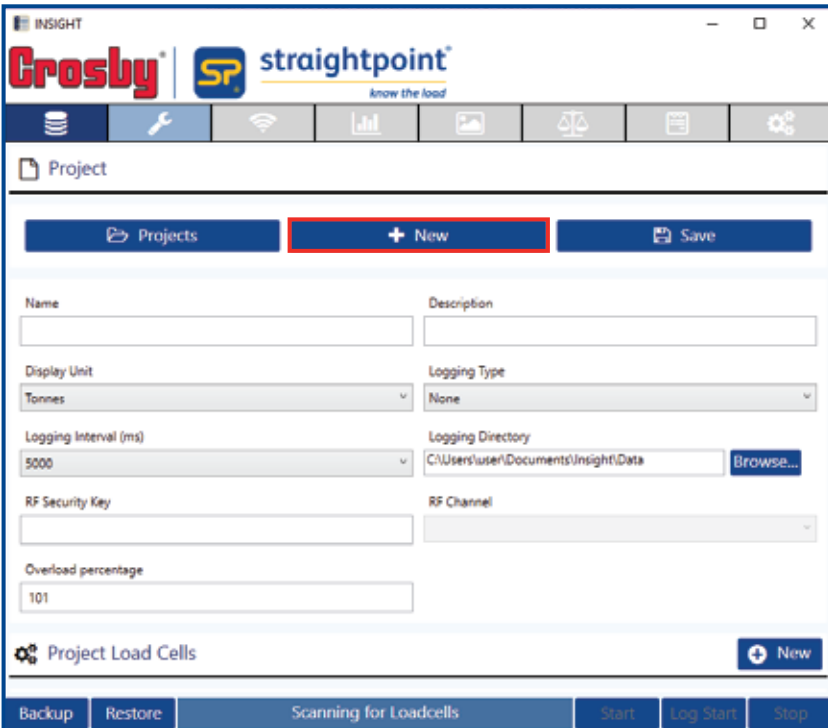

Once '+New' is clicked, please enter the following information:-

Project Name and description

Provide a project name ('Name') and description ('Description') as plain text.

Units

Select the project units from the dropdown box for either Tonnes / Kilograms / Kilo Newtons / Pounds ('Display unit descriptions'), these units supersede the units shown in the load cell database.

Setting up a Project (contd.)

Logging Type (select option from the drop-down list)

- 'None'
No logging will be performed, and no log data files will be created.
- 'Continuous'
All data from the load cell(s) will be logged to the data file at the Logging Interval. Logging must be initiated by pressing the 'Log Start' button.
- 'Manually Triggered'
Single data values will only be logged to the file if the 'Log' button is pressed.
- 'At Alarm'
The data value which first exceeded an alarm condition will be logged to the data file. Logging must be initiated by pressing the 'Log Start' button.
- 'While In Alarm'
Data values are logged to the data file while the stated alarm conditions are exceeded. Logging must be initiated by pressing the 'Log Start' button.

Logging Interval (ms)

Enter the interval you want the data logged at to the data files. This overwrites the measurement interval selected for the load cell. You should not select a logging interval which is at a greater resolution than the load cell measurement interval.

The logging interval is in milli-seconds; hence the value of 1000 is 1 second.

Logging Directory

Enter the directory path where the data files are to be stored. This path is also used for the COG report.

Note: The default path is linked to the user's profile and is normally:-

'C:\users\your-name\documents\Insight\Data — It may have been mapped differently on your network.

RF Channel and Security Key

By default, the system uses RF channel 15 and the security key field is left empty. These values are ported across from the first load cell that was added to the project and are therefore not editable.

Overload %

This is the percentage of the load cells' WLL. If that percentage is exceeded, the text 'OVERLOAD' is displayed instead of the data load value. By default, the value is set to 101. Set to 0 (zero) to turn off this feature.

Please make sure you select the 'Save' button before moving onto other displays (highlighted below).

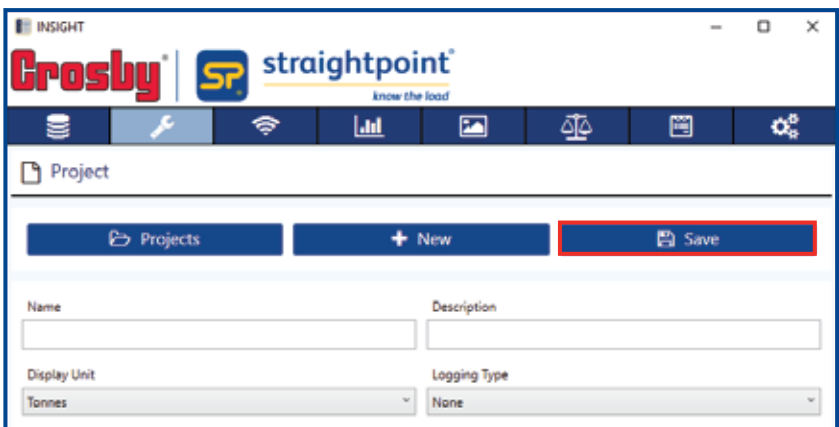

The screenshot shows the 'Project' configuration window in the Crosby Straightpoint software. At the top, there are navigation icons for database, tools, Wi-Fi, charts, images, scales, and settings. Below the icons, there are buttons for 'Projects', '+ New', and 'Save' (highlighted with a red box). The main area contains two columns of input fields: 'Name' and 'Description'. Below these are two dropdown menus: 'Display Unit' (set to 'Tonnes') and 'Logging Type' (set to 'None').

Project Load Cells

Load cells from the data base must now be associated with a project. This is done by selecting the Project Load Cells '+New' button

Further load cells can be added via the '+New' button, once the information for one load cell is entered and saved.



A window, entitled 'Edit Project Load Cell' will then appear.

Edit Project Load Cell

Within this screen you can select a load cell for the project or use a formula based on a load cell. You can also set up alarms, COG details and other settings.

Please make sure you select the 'Save' button before moving onto other displays.

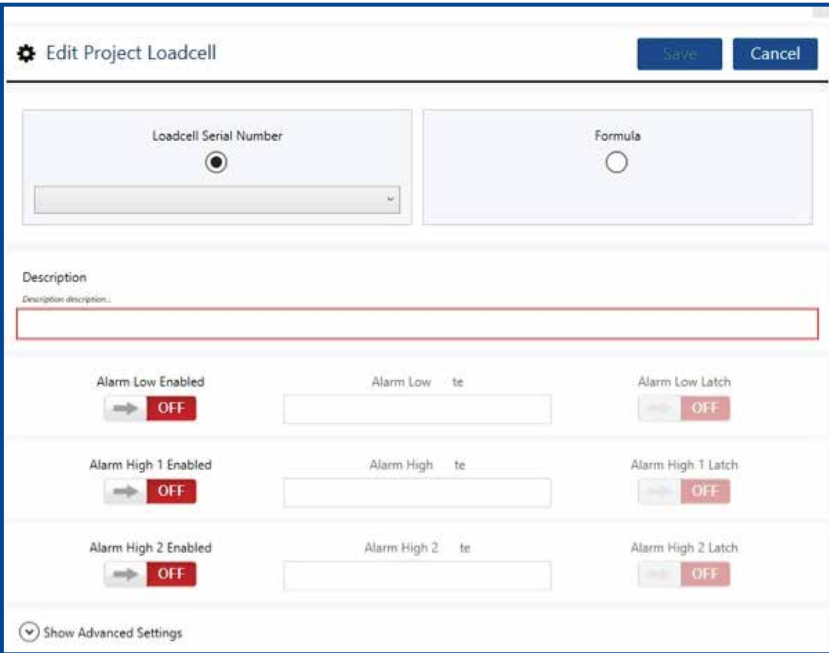

Project Load Cells (contd.)

Load Cell Serial Number

For uses such as displaying load cell data. It is likely the load cell serial number is the only field you will need to visit and use. This option associates a load cell with a project for data display or COG calculation. The added load cells in project also will list out in the Proof Test section, so the user can select the required load cell from that list and can use for Proof Test applications.

The radio button defaults to 'Load Cell Serial Number' but if it is moved to formula then reselect it on the Load Cell Serial Number.

Selecting the drop-down field within the load cell serial number option will show a list of serial numbers from the load cell data base. Select one of these load cells from the drop-down list to use within the project. This will associate this load cell with the project for use in displaying the load cell data and using it in the COG calculation.

The description field defaults to the same as the load cell serial number, however, any text string can be entered here.

Formula

Instead of using the load cell's data readings directly (as shown on the previous page), a formula based on the load cell data readings can be used. This can be useful if custom units with a conversion factor are required, or the sum of several load cells is required.

The load cell to use in the formula can either be entered directly with its serial number in square brackets e.g. [123456] Alternatively, the load cell can be selected in the drop down list from the load cell serial number and then by clicking the 'Formula' button to transfer it to the formula expression.

For example, to convert the data reading in Tonnes to read in Pounds the formula would be follows:

[111111]*2204.62

*The serial number of the load cell is shown in square brackets [111111]

To sum four load cells use:

[111111]+[123456]+[123411]+[123422]

The expression parser recognises the following symbols:

+	{Plus}
-	{Minus}
/	{Divide}
*	{Multiply}
()	{Parenthesis}
[xxxxxx]	{Load cell serial number in square brackets}

... and decimal numbers

The parser must encounter a load cell serial number as the first item; hence:

2*[123456] is not legal

[123456]*2 is legal

Examples of allowable formula:

- [111111] + [234567]
- [111111]*2.5
- [111111]+2.0
- ([111111]*2)+100
- ([111111]*2204.62)/100
- ([111111]*2)/(2*[222222])

Examples of disallowed formula:

- 2*[111111]
- (2*[111111])
- (2*6)

Project Load Cells (contd.)

Description

Add descriptive information about the load cell ('Description' highlighted below) to help reference where it is being used in the actual lifting set-up. This description will be used to identify the load cell throughout the program and reports. The default for the description field will be created automatically as the load cell serial number.

Please make sure you select the 'Save' button before moving onto other displays.

Alarm Settings

Three types of Alarm can be generated locally from the INSIGHT software:

- **Low**
The Alarm condition is met when the reading value goes below the entered 'Alarm Low' value.
- **Alarm High 1**
The Alarm condition is met when the reading value goes above the entered 'Alarm High' value. This alarm can be thought of as a Warning level.
- **Alarm High 2**
The Alarm condition is met when the reading value goes above the entered 'Alarm High 2' value. This alarm can be thought of as an Error level.

Project Load Cells (contd.)

To enable an alarm, click on any of the 'Low / High 1 / High 2 Enabled' buttons to turn it on (green).

Enter the threshold value - above for 'Alarm High', or below for 'Alarm Low' that you want the Alarm to activate on. This value will be in the units you have previously selected.

Finally, if you require the alarm to latch on, once the threshold has been reached, then click the 'Alarm Low / High 1 / High 2 Latch' button.

These Alarms work individually on each load cell or formula. The number entered is an absolute value and not a percentage of WLL.

If the Alarm threshold is breached, the load cell display will show the Alarm in Red, and the PC speaker will beep.



For example, a Low Alarm has been set up and has crossed the threshold.

If the Alarm Latch is set and the threshold is passed, the alarm will continue even when the alarm condition goes back within the threshold.

To clear this press the 'Stop' communications button available on the bottom right corner and then press 'Start' to restart the display if required.

Advanced Settings

If you expand the 'Show Advanced Settings' tab there are a range of further settings.

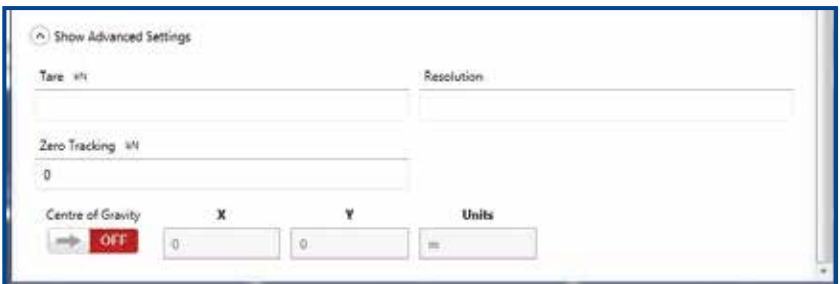

Project Load Cells (contd.)

- **Tare**

Enter a value here to compensate for the weight of shackles etc. This value will be subtracted from all readings Net or Gross.

- **Resolution**

This is read from the load cell and was set up when it was commissioned. It is based on the WLL and therefore it is unlikely that it/they will need to be changed. If displaying data from multiple load cells with different resolutions, then the resolution can be adjusted to align with other load cells. The Resolution defines the 'step' that data values take (in the case shown above (0.02) the value could go from 1.02/1.04/1.06 etc.), and this automatically sets the number of decimal places which are displayed in the readings.

- **Zero Tracking**

This is read from the load cell and was set up when it was commissioned. Consequently, it is unlikely it will need to be changed, but can be altered if required. Enter a value below which data readings will be displayed as zero.

- **Centre of Gravity**

Clicking on this option enables this load cell or formula to take part in 'Centre of Gravity' calculations. Three further fields are associated with this.

- **X and Y co-ordinates**

Enter local X and Y co-ordinates of the load cell's position (relative to a locally defined 0,0 point or global co-ordinates) for the centre of gravity calculation: these can be in units of your choice - metres or feet etc.

- **Units**

Enter the units for the local X and Y co-ordinates as a text string such as metres.

Please press the 'Save' button to save all the settings related to the load cell into the project.

Load Cell Displays

Once you have set up the project and assigned the load cells required, the software will be able to display the load cell data readings for you to view.



You will then be presented with a matrix of the load cells and formula that you have included in the project. An example of two load cells included in the project is shown below:

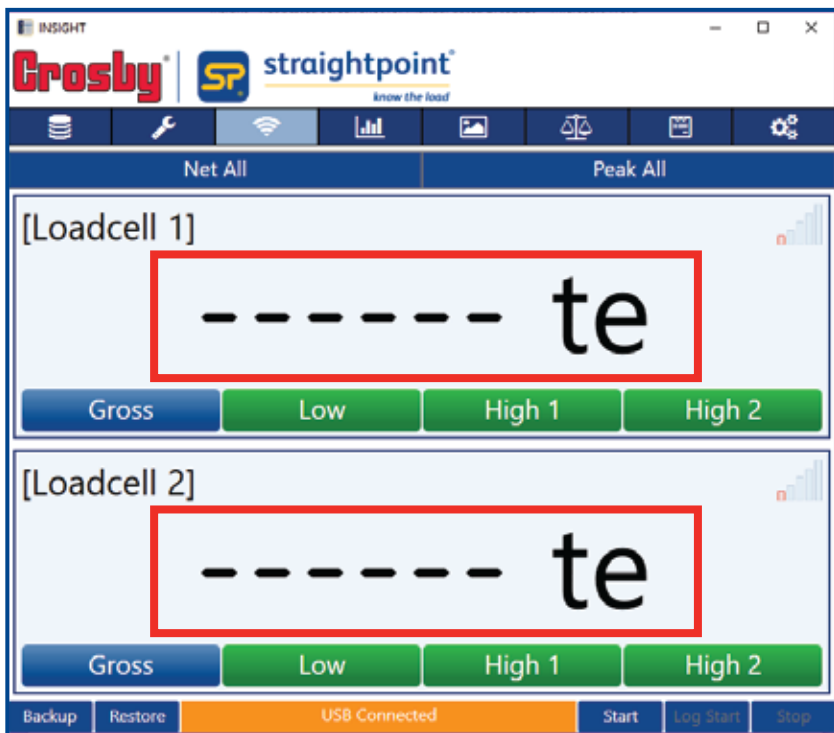

The display shows an individual entry for each of the load cells or formula. Each has a description, and also the data reading, which in this example is blank because the data readings capture process has not yet started (highlighted in the image above).

Please click the 'Start' button at the bottom right corner to start the data reading capture process. The reading will then start showing instead of the blank screen. Existing projects can be selected from 'Projects' which is available on the project set-up page. The same procedure can be used to start the data capture process.

Load Cell Displays (contd.)

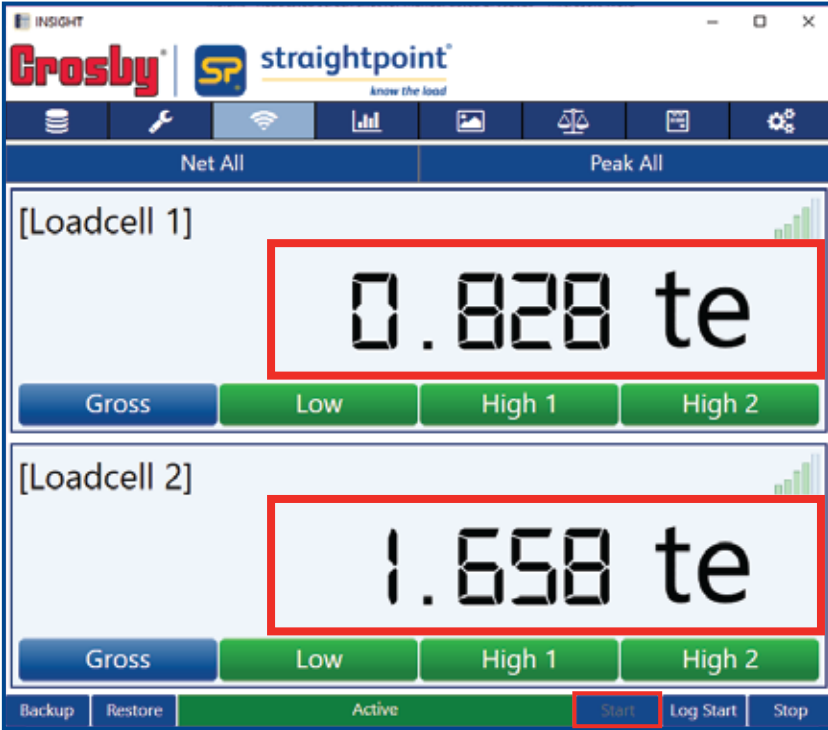

This screen shows a 'Gross' or 'Net' reading. Please click on this button to display one or the other.



This screen shows a 'Gross' or 'Net' reading. Please click on this button to display one or the other.



Three possible alarms are shown, 'Low', 'High 1' and 'High 2'.

Load Cell Display Icons

Load cell warnings and errors will also be displayed for overload situations (shown as 'Overload'), load cell internal overload error (shown as 'LC error'), calibration due, and low battery.

To display data readings from the load cell(s) click the 'Start' button in the bottom right hand corner.



RF Signal Level

The RF signal level is displayed as five bars, which will be filled in when the data readings are shown.

OVERLOAD

Overload Warning

This text replaces the displayed reading when the load cell value has exceeded the Overload Percentage field of the Project setup parameter.



Load Cell Error

The load cell has exceeded its internal mV/V value. If this icon persists, the load cell needs to be returned to Crosby|Straightpoint.



Load Cell Low Battery

This is a transitory warning which will clear when the user inserts new batteries into their load cell.



Overload Error

The load cell has exceeded its WLL (Weight Load Limit) by more than 10%. It will need to be recalibrated since the strain gauge component could be damaged. This is a permanent error and will continue to show until the load cell is recalibrated.



Calibration Due Warning

It has been approximately a year since the load cell has been calibrated by Crosby|Straightpoint and it requires calibration. This is a permanent error and will continue to show until the load cell is recalibrated.

Load Cell Charts



The main chart display shows this graph icon in the window, this graph is a constantly moving timeline of the data at the current time.

There is a shadow graph at the bottom of the screen outlining the whole graphing period. This is overlaid with a rectangular shadow block, which represents a cursor. This shows the portion of the data being displayed in the current main graph. This cursor can be dragged to the left (using the mouse) to display data from a different timeline in the main graph. It is most effective if the '**Stop**' button is clicked, otherwise the display will revert to graphing the current timeline.

- Click the chart '**Stop**' button to keep charts open but make sure you freeze the time so no readings are added to the charts.
- Click the chart '**Clear**' to clear both graphs on the screen to restart the chart.
- Click the '**Record**' button to start charting again.
- To expand or contract the horizontal scale on the timeline, use the mouse scroll wheel.
- To view another position of the chart, click and hold the mouse cursor and drag it left or right.
- The '**Max History**' field shows how many readings are stored before the buffer is overwritten (effectively the size of the graph shown).
- The recording '**Interval**' is the interval over which to accumulate data readings and update the display.
- Click the checkbox beside the load cell description to remove that load cell from the graph.

Visualisations

Visualisations allows the user to visualise the set-up and positioning of the load cell(s) with live data reading on screen with a picture background also being provided.



This is achieved by the user uploading an image of the set-up via the top right-hand corner 'Load Image' button (see icon on the left) and then dragging the load cell data reading boxes to their positions on screen.



Once this is done select the 'Save' button (see icon on the right) in the top right-hand corner.

Note:

- When 'Save' is selected it will automatically stop the data readings, which must be restarted after the save is performed.
- If no visualisation setup is done, all the loadcells' data reading boxes will be arranged in the top left corner and show as a single data reading box.

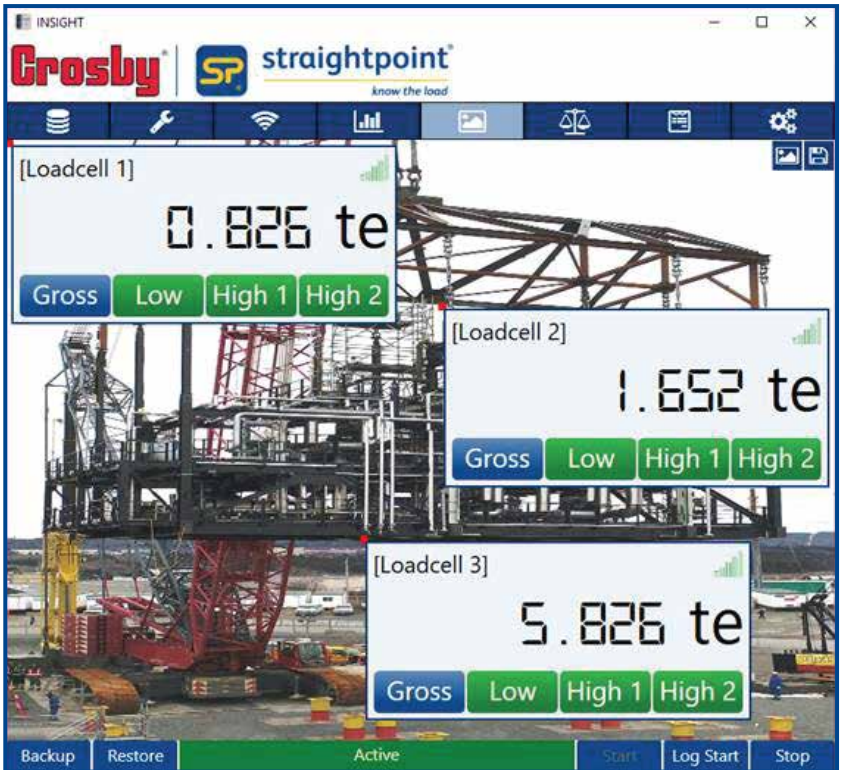

Reports

The 'Report' feature takes the current load cell display reading and exports it to a report file, either as plain text or an HTML format file.



When the 'Generate Report' button is clicked, the software automatically generates a report file from a template and fills it with data from the project, including the project's name. It is then exported to the Report Output Directory, so that it can be viewed by the user.

This function also gives the user the flexibility to create their own report template files containing tokens to produce customised reports. To generate a report, the minimum that is required, is for the user to edit or create a template file and insert the serial number of their load cells.

The tokens which can be used in a plain text or html file are as follows:

Token	Evaluates to:
++PN++	Project Name
++DT++	Current Date as DD Month 2019
++TM++	Current Time as HH:MM:SS
++SD[xxxxxx]++	Description of Load Cell [xxxxxx]
++SV[xxxxxx]++	Current Data Value of Load Cell [xxxxxx]

An example of a tokenised plain text file would be as follows:

Project - ++PN++

Example Simple Text Report

Date: ++DT++

Time: ++TM++

<i>Load Cell</i>	<i>Description</i>	<i>Value</i>
<i>[123411]</i>	<i>++SD[123411]++</i>	<i>++SV[123411]++</i>
<i>[123422]</i>	<i>++SD[123422]++</i>	<i>++SV[123422]++</i>

This produces the output file

Project - aproject

Example Simple Text Report

Date: 29 April 2019

Time: 16:39:05

<i>Load Cell</i>	<i>Description</i>	<i>Value</i>
<i>[123411]</i>	<i>123411</i>	<i>23.36</i>
<i>[123422]</i>	<i>123422</i>	<i>20.80</i>

Reports (contd.)

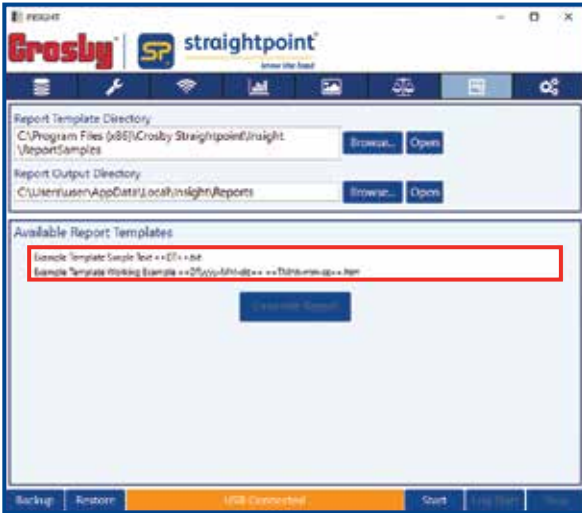

Select which template you want to use from the report templates window (it will also list any templates that you have created using the provided tokens).

How to produce a report:

1. Browse to a directory containing the report template files shown below (these will be displayed in the Available Report Templates window).

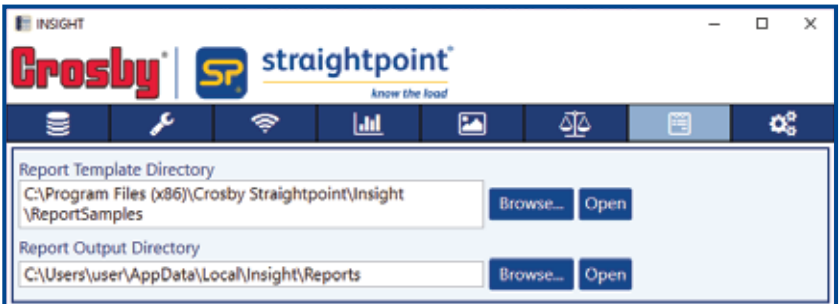

2. Browse to a directory to contain the output report.
3. Select the 'Start' button in the lower right-hand corner of the screen to initiate a data reading capture.
4. With the cursor, highlight the template file you wish to use from the list within the 'Available Report Templates' window.
5. Press the 'Generate Report' button
6. The report will be generated, displayed and saved to the newly created page.

Centre of Gravity

The program has the ability to calculate the Centre of Gravity (CoG) of the load object, and produce a screen visualisation and report from this.

There are two methods of entering the position of the load cells:

1. Using local relative co-ordinates, e.g. specifying metres from a fixed point.
2. Using global North and East co-ordinates used in the UTM system.

In order to use a load cell for a CoG project, the user must first specify the X and Y co-ordinates of its position in the 'Advanced Settings' section within the 'Edit Project' load cell menu. The CoG feature must be enabled, and the load cell's position co-ordinates must be entered. You can enter local or global co-ordinates along with the 'Units' field for the local co-ordinates.

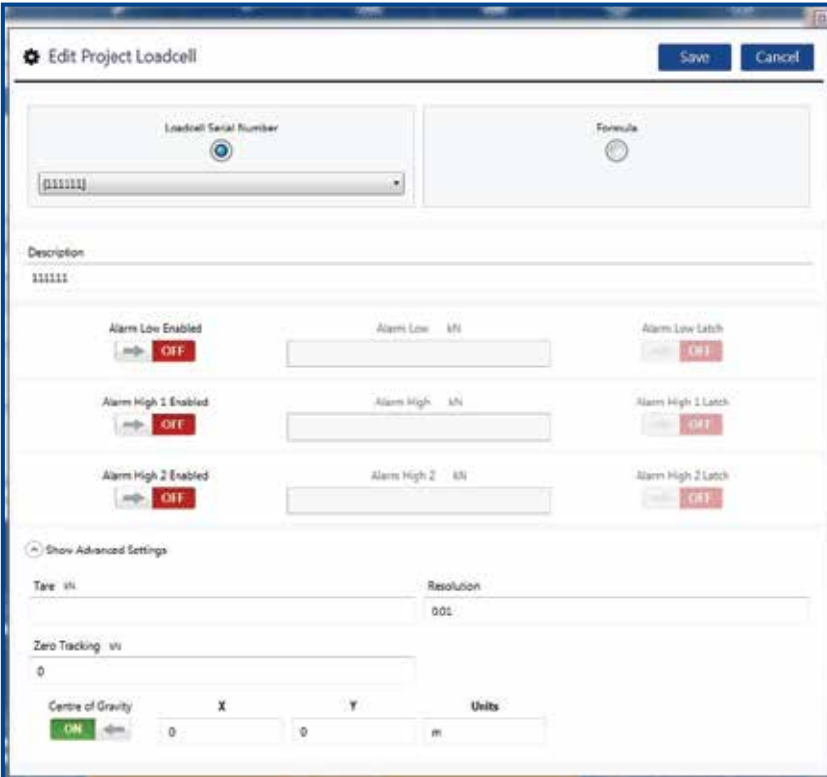

Once you have entered all the information for the CoG load cell, go to the CoG screen by clicking this option button (see icon opposite).

Centre of Gravity (contd.)

Now enter the Job Details items and save it:



If not already done, the data reading capture must be started by clicking the 'Start' button. Values will be displayed in the load cell display screen if required.

The CoG screen should now be displaying the CoG position. The load cells which contribute to this CoG, appear as blue circles of size proportional to the weight of the load cells. The user can do Net All / Gross All using the available 'Net All' button.



The CoG is displayed in the centre with a cross through a circle, as shown here.

Note: The load value and position will be displayed within the blue circle but this has been removed in the screen shot opposite, for clarity.

Centre of Gravity (contd.)



The CoG co-ordinates and weight are displayed with the CoG. Select the required number of recordings from the drop down menu. A maximum of 10 recordings can be done.

Once a position of stability has been achieved, readings for the report can be obtained.

To record the load values click the consecutive recording as 'Record 1', 'Record 2' up to 'Record N'. The 'Record' button will not be available, however, you can review the data reading taken, then reject and redo, if necessary.

To generate a report, please click the 'Generate Report' button (the html report will be generated) as shown below:

17/06/2020 Centre of Gravity Report

straightpoint[®]

know the load

WEIGHING RESULTS
Project

Date: **Wednesday, 17 June 2020**

Operator:
Project:
Project Number:
Client:

COG Units: **m** Weight Units: **lbs**

Environmental Conditions

Temperature		Wind Speed		Wind Direction	
-------------	--	------------	--	----------------	--

Coordinates

Cell Position	Cell Description	X	Y
1	CCCCC1	0	0
2	CCCCC2	0	10
3	CCCCC3	10	0

Load Cell Input

Cell Position	Description	Weighting 1	Weighting 2	Weighting 3	Weighting 4	Weighting 5	Weighting 6	Weighting 7	Weighting 8	Weighting 9	Weighting 10	Mean
1	CCCCC1	6144	6156	6146	6150	6148	6146	6146	6146	6144	6146	6147.2
2	CCCCC2	1642	1644	1646	1644	1644	1644	1644	1644	1644	1644	1644
3	CCCCC3	8220	8220	8200	8200	8200	8200	8200	8200	8200	8200	8204
TOTALS		16006	16020	16002	16004	16002	16000	16000	16000	16000	16000	16005.2

COG Result

	Weighting 1	Weighting 2	Weighting 3	Weighting 4	Weighting 5	Weighting 6	Weighting 7	Weighting 8	Weighting 9	Weighting 10	Mean
COG X	5.13567	5.13109	5.12756	5.12692	5.12756	5.12621	5.12621	5.12621	5.12685	5.12604	5.12904
COG Y	1.02567	1.02622	1.02606	1.02789	1.02801	1.02814	1.02814	1.02814	1.02827	1.02814	1.02781

MEAN TOTAL WEIGHT: **15995.2** Mean Centre of Gravity

Standard Deviation Weight: **10.06** COG X **5.12904**

Standard Deviation in Percent: **0.06** COG Y **1.02781**

Notes:

	Name	Signature	Date
Client Representative			
Customer Representative			

The generated report will be available in the logging directory folder, folder can be selected using 'View Reports' tab.

Proof Test Plus (PTP)



The Crosby|Straightpoint INSIGHT Proof Testing Software package allows wireless monitoring at a safe distance of non- destructive load verification or proof testing. Test data is presented in the form of a Certificate of Testing and can be printed out directly as a PDF report or electronically transmitted/stored.

Typical applications include:

- Crane testing with water bags or block weights
- Pad eye or flypoint testing
- Crash barrier testing
- Construction equipment testing, such as shoring columns, Acrow props and lintels
- Lifting and spreader beam
- Hydraulic cylinder load testing
- Lifting equipment testing, such as slings, chains, wire rope, hooks etc.

Features:

- User-friendly interface
- 100 % wireless – eliminates problems caused by damaged cables
- 700m (2300 ft) range allows operation at safe distance from test
- Connects to any Crosby/Straightpoint TS range wireless load cell or loadshackle
- Log data at speeds up to 200Hz
- Connects to any Crosby|Straightpoint wireless loadcell or loadshackle
- Automatically creates digitally signed pass or fail certificate
- Real time load v time graph display
- Free entry fields to note wind speed, sea states etc.



CAUTION

Ensure Crosby|Straightpoint wireless load cells are handled and used in accordance with the safety instructions within the appropriate Load cell User Manual. This is supplied with the load cell.

Other equipment used in conjunction with Crosby|Straightpoint load cells, such as jacks, hydraulic cylinders, chains, strops, lifting frames, and other material handling equipment, must be inspected, checked, handled and used in accordance the appropriate manufacturer/supplier information and/or with all pertinent regulatory requirements and industry standards/codes of practice.

Set-up

Once the PTP is selected, the set-up screen shown below will appear.

The screenshot shows the PTP setup interface. At the top, there is a navigation bar with the Crosby and straightpoint logos and the tagline 'know the load'. Below the navigation bar is a warning message in a yellow box with a black exclamation mark icon: 'This setup process must be completed the first time while entering in to the PTP screen. Setup information is unique to each activation code. Carefully check all the information is correct before clicking 'Save' as this screen cannot be retrieved without re-activation.' Below the warning are several empty input fields for company information: 'Company Name', 'Address 1', 'Address 2', 'Address 3', 'Address 4', and 'Zipcode/Postcode'. A 'Load' button is visible at the bottom left of the form area.

This setup process must be completed the first time while entering in to the PTP screen. Setup information is unique to each activation code. Carefully check all the information is correct before clicking 'Save' as this screen cannot be retrieved without re-activation.

1. Enter company information.
2. Enter three alpha numeric characters into the 'Certificate Prefix' box. This is optional, but remember, it cannot be subsequently added or amended. See note above.
3. Click on the button to upload a .PNG of your company logo, recommended size of 320 x 95 pixels.

The company information and logo entered during set up will appear as the header information on the printed test reports and certificates generated by the system, along with the certificate number prefixed by the alpha numeric characters entered.

The screenshot shows the PTP setup interface with the form filled out. The 'Company Name' field contains 'Your Company Name'. The 'Address' fields contain 'Address Line 1', 'Address Line 2', 'Address Line 3', and 'Address Line 4'. The 'Zipcode/Postcode' field contains 'POST CODE'. The 'Telephone' field contains 'Phone Number'. The 'URL' field contains 'www.yoururl.com'. The 'Certification Prefix' field contains 'Required Prefix'. A 'Load' button is visible at the bottom left of the form area.

Set up engineers

After the software has been set up as detailed in section 3, the system is ready to use.

To add an Engineer:

1. Enter Engineer Name.
2. Add ID and Qualification, if applicable.

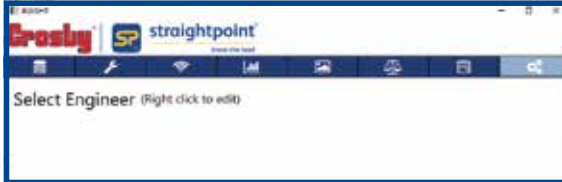

3. Click on the button to add the Engineer to the database.
4. If Engineer(s) have been previously added, they may be selected for a test from the database.

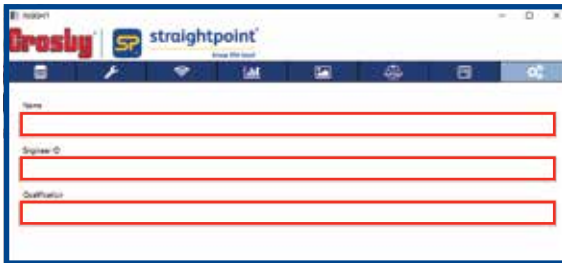

To edit or delete the details regarding an engineer, right click on the engineer's name in this screen.

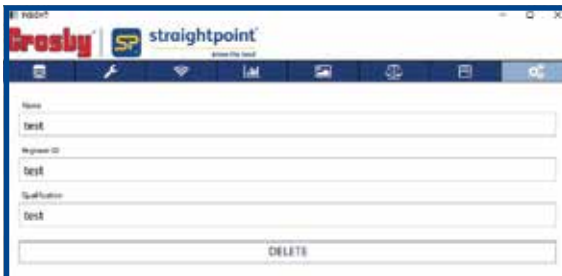

Select load cells

To select a Straightpoint TS range load cell or load shackle:

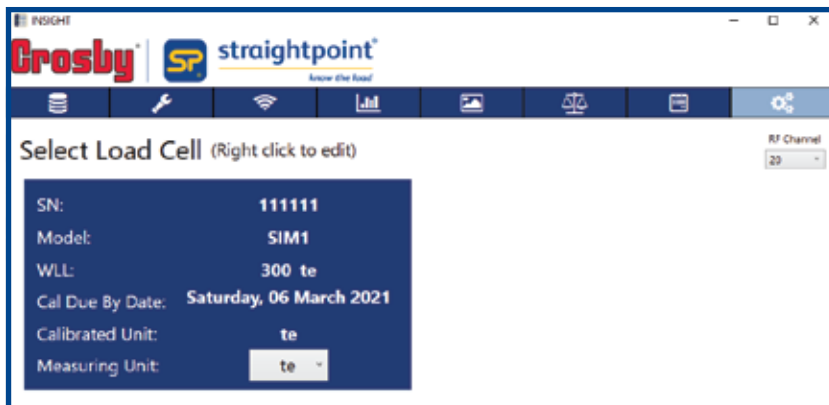

1. Check the required serial number and model available in the list. (This list will show the load cell only if it is added in project).
2. User can search the load cell based on RF channel as well, default channel is 15.
3. Once the required load cell is identified, select the preferred unit of measurement. Choose tonnes or lbs from the drop-down in the Measuring Units tab.





NOTE: If a load cell/load shackle is selected that is outside of the recommended re-calibration period of twelve months a pop-up warning screen will be displayed.

CALIBRATION

The load cell you have selected appears to be out of calibration (12 months). Has it been recalibrated?

If the load cell/load shackle has been re-calibrated, please click on the button and enter the new re-calibration date. (This change is only local, to change the actual load cell calibration date, contact Straightpoint or its dealer).

If the load cell/load shackle has not been recalibrated, a test can still be carried out but the final certificate will note that the test was performed using a load cell/load shackle out of the Crosby|Straightpoint recommended calibration period.

Set up customer

To add details of a new customer having a load verification or proof test:

1. Enter customer name, address, telephone and contact name.
2. Click on the **Add Customer** button to add the customer to the database.
3. If customers have been previously added, they may be selected from the database, or they can be searched by entering their name or address and using the **Search** button.

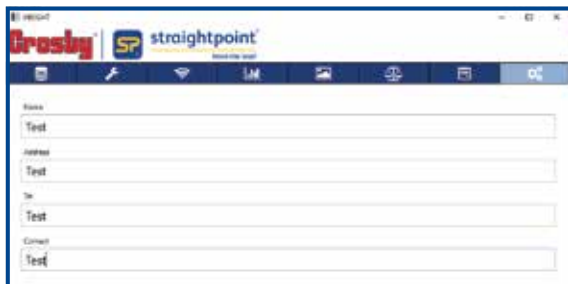

Set up load test

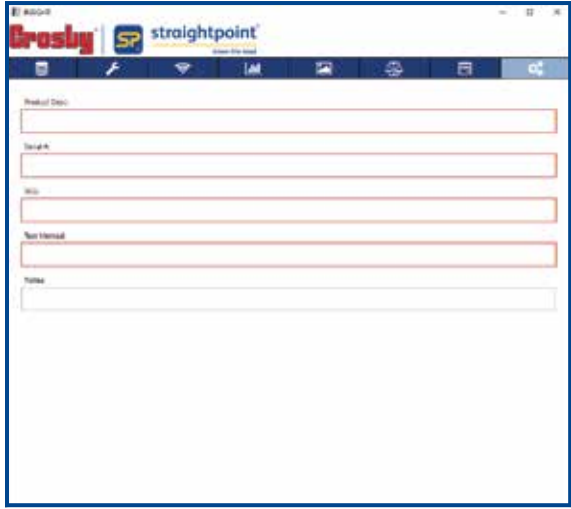

To set up the load test:

1. Enter a description of the product to be verified/proof tested.
2. Enter its serial number.
3. Enter the working load limit (WLL).
4. Enter the test method – such as water bag, block weight etc.
5. Note – user can add required notes but not a mandatory field.



Testing

To carry out a load verification or proof test, firstly, enter details of the scope of the test.



1. Enter the value of the load to which the test is to test to (Load Test To:).

The Default Display Unit' can be changed by making a selection using the drop down in the 'Measuring Unit' box. The calibration certificate will show the selected unit.

2. Enter the Start Threshold. This is set to 10 % by default, but may be adjusted. This is the point at which the software will start to log the applied load.
3. Enter the Read Interval. This is set to 0.5 (seconds), or 2 times per second, by default, however, it may be adjusted up to 200 times per second.

4. Select the checkbox PEAK where required. In this mode, live load reading and graph will hold and show the peak value attained during the test. Otherwise instant load values will be displayed.
5. Use the **ZERO** button to toggle between Net and Gross weight. When the button displays 'Zero', the load will be gross weight. When displaying 'Gross', the load will be nett weight.
6. Once entered all data and press the **Start** button. The traffic light will turn to ● to indicate that a successful connection has been established with the load cell/load shackle. Once the Start Threshold is reached, the traffic light will turn to ● indicating that recording has started. Once the load cell is overloaded traffic light will turn in to ● indicating that the load cell is overloaded.



The on-screen graph will now populate with data as the test progresses, and at the same time, the Live Read window will show a live spot load reading.

7. When testing is finished, click on the **Stop** button and for saving, click on the Save button. The adjacent screen will be presented:

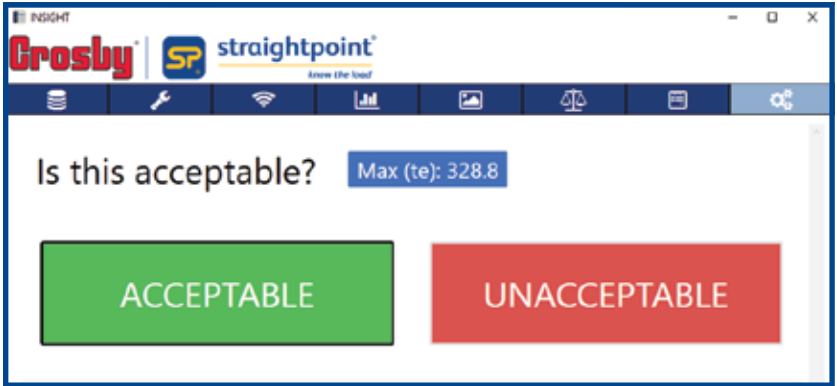

8. If the test is acceptable, click **ACCEPTABLE** .
9. The 'Notes' field may be used to add any comments regarding the test.
10. Then click **Save** .
11. When the pop-up appears, click on OK. The system will return to the start of the test.
12. If, for some reason, the test has proved unacceptable, click **UNACCEPTABLE** . The 'Notes' field can be used to enter test failure details or similar.



13. After adding any notes, select **Complete** , then OK, the system will return to the start of the test.

Test Reports/Certificates

After completing the test and step 11 or 13 in the previous section, the system will return to the screen below:



1. Click the [View Certification](#) button at the bottom of the screen. This will reveal the screen shown below:

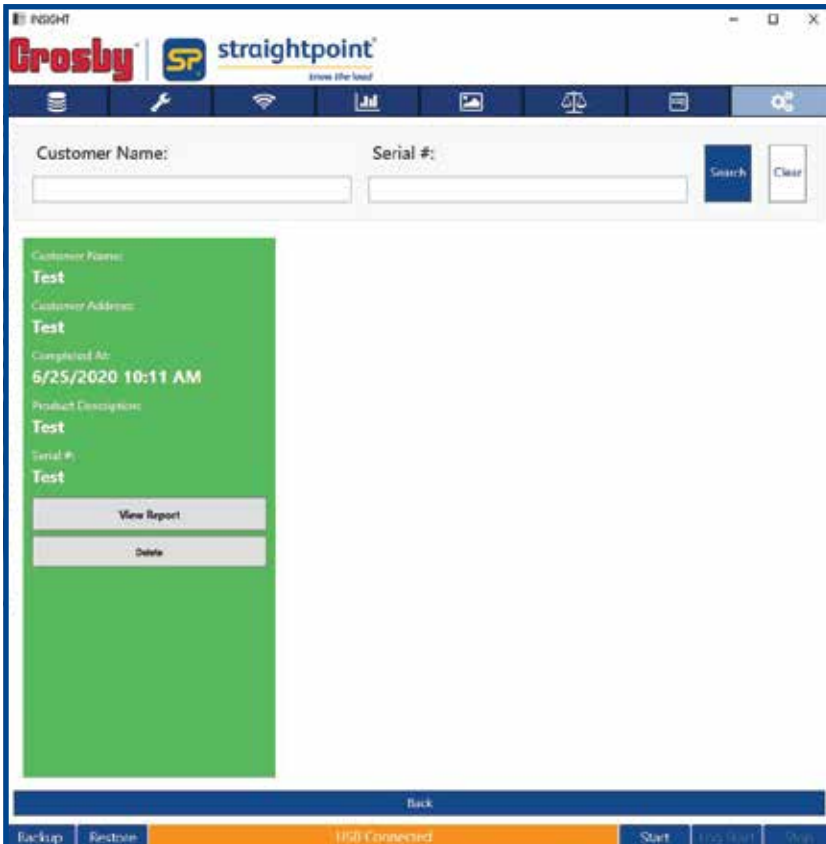

2. Select certificate from the list.

Listings coloured **GREEN** are for tests that passed.
Those coloured **RED** are those that failed.

Reports/Certificates may also be accessed using the search facility using the customer name or the serial number of the item tested.

3. Click View Report and the test certificate will appear on screen.
4. To remove a Report/Certificate, click 'Delete' to reveal a pop-up that will ask for confirmation that the Report/Certificated is to be deleted.



know the load

Your Company Name
Address Line 1
Address Line 2
Address Line 3
Address Line 4
POST CODE
Phone Number
www.yoururl.com

Certificate of Load Test - 13/03/2020 10:13:49

Date of Test:	13/03/2020 10:13:49	Product Description:	ofs
Certification Number:	Required Prefix-10001	Serial or Tag No:	sdj
Company	Test	WLL	asf
Address	Test	Test Method	sdids
		Load Test To:	300te
Tel:	Test	Duration of Test:	33.59 seconds
Contact	Test	Notes:	fsd
Reference Loadcell:	SIM1	Calibrated On:	Wednesday, 06 March 2019
Serial Number:	111111	W.L.L:	300
Calibrated Unit:	te	Measuring Unit:	te

Peak Load: 329.8 te



This is to certify that this product described herein has been subjected to the load test.
Caution: Never exceed the rated capacities.

Notes: Test Notes Test Notes Test Notes Test Notes Test Notes Test Notes

Signed:

Appointed Person: ID:

The Report/Certificate may be saved, printed, emailed or exported to Microsoft Excel and other programs.

If the test was deemed **UNACCEPTABLE**, the load test graph will not be displayed.
The fail notes will be included instead.

Data Logging

While communication with the load cell(s) is in progress, you can start logging by clicking the 'Log Start' (logging) button. When the 'Start' button has been pressed (or while the load cell is scanning) and data is being read from the load cell, many of the standard menu options are not available. You will need to stop the scan or communication in order to be allowed access to menu items.

Logged Data File format

Logged data files are created and saved within the specified logging directory with a file name which follows this format:

Insight.20YY-MM-DDTHH-MM-SS.csv

The file name format is independent of any regional date and time variations.

For example: **Insight.2019-04-25T10-48-38.csv** was created at 10am 48mins 38sec on 25th April 2019

The file format is saved as a standard comma separated variable (CSV), ready to read within a spreadsheet of your choice.

It has one header line, with the date and time, followed by the load cell serial number(s)

Example:

Date	Time	Elapsed Time (ms)	123411	333333
2019-07-02	11:31:53	5000	14,580	16,088
2019-07-02	11:31:58	10000	14,580	16,089
2019-07-02	11:32:03	15000	14,580	16,088
2019-07-02	11:32:08	20000	14,580	16,090
2019-07-02	11:32:13	25000	14,577	16,086
2019-07-02	11:32:18	30000	14,577	16,089
2019-07-02	11:32:23	35000	14,576	16,089
2019-07-02	11:32:28	40000	14,578	16,087

Backup and Restore Functions

INSIGHT has the ability to preserve the projects and settings using the backup and restore function.

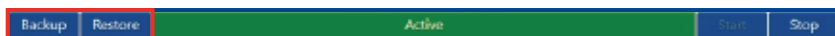

The backup function should only be used periodically, to guard against accidental project data deletions.

Select the 'Backup' button in the lower left-hand corner to preserve INSIGHT data, this saves the state to a file called configuration.xml and defaults to the INSIGHT directory.

Projects and state can be restored at any time by use of the 'Restore' button.

A secondary optional function of the 'Restore' button, is to install ready-tailored projects and load cell details supplied by Crosby|Straightpoint.

Appendix A

Installing software to Windows 10

While attempting to install INSIGHT software on to a computer with a Windows 10 operating system you may encounter the following pop-up window:



To allow the continuation of the installation, click on '[More info](#)'. You will then be given this next pop-up window text.



Select 'Run anyway' to instruct Windows to continue the installation.

Glossary of Icons

This is a quick guide to explain what each icon refers to. They are in chronological order (as they appear within).



INSIGHT

Double click this icon to run the program.



Alarm

Alarm threshold has not been breached.



Load Cell Database

Capture existing load cells into the data base.



RF Signal Level

Indicates load cell signal strength.



Project Settings

Click this to create and edit Project Settings.



Load Cell Charts

This graph is a constantly moving timeline of the data at the current time.



Projects

List existing Projects.



Load image

Load a picture to form a backdrop for the data visualisations.



Alarm

The alarm threshold has been breached.



Save

Save a previously loaded picture (to form a backdrop for the data visualisations) so it will be automatically reloaded.



Load Cell Displays

This is to display load cell data readings.



Generate Report

When this button is clicked, the INSIGHT software automatically generates a report file.



Centre of Gravity

Click on this button to go to the Centre of Gravity screen.

Once there, select either the 'Gross' or 'Net' button.



Proof Test Plus Software (PTP)

Click on this button to go to the PTP screen.



This user guide has been compiled to cover the latest product description and specifications. Crosby | Straightpoint reserves the right to make changes to the contents herein without notice and shall not be responsible for any damages (including consequential) caused by reliance on the information provided, including but not limited to technical or editorial errors or omissions.

The only warranties for Crosby | Straightpoint products and services are set forth in the warranty statements accompanying such products and services. Nothing herein should be construed as constituting an additional warranty.

© This user manual is the property of Crosby | Straightpoint.

To make it easier in the event you need technical support customer service, please complete the following information:

Software Version:	
Media:	USB memory stick <input type="checkbox"/> Download <input type="checkbox"/>
Date of Purchase:	

Trademarks

Windows® 7, Windows® 8 and Windows® 10 are registered trademarks or trademarks of Microsoft Corporation in the United States and other countries.

Marks and Symbols



The following symbols may be used within this user guide.



IMPORTANT

Indicates a note or where attention is required.

Indicates an important step, instruction or information necessary for the proper functioning of the software or loadcell monitoring.



CAUTION

Indicates a potentially hazardous situation that if not followed or avoided may result in personal injury or damage to property.

Contact Details

Crosby | Straightpoint

Unit 9, Dakota Park
Downley Road
Havant, Hampshire
PO9 2NJ · UK

Tel: +44 (0)2392 484491

Crosby | Straightpoint

2801 Dawson Road
Tulsa
OK 74110
USA

Tel: +1 (918) 834-4611

Notes

v2.00
Part No:
SU6045

Distributor Stamp



Crosby | Straightpoint

Unit 9, Dakota Park, Downley Road, Havant, Hampshire, PO9 2NJ UK · Tel: +44 (0)2392 484491
2801 Dawson Road, Tulsa, OK 74110 · USA · Tel: +1 (918) 834-4611