

Serial Device Server

ICDM-RX/TCP-32RJ45/RJ45-RM



- Web-based configuration
- RS-232/422/485 software selectable interfaces
- NEMA TS2 Certified
- TCP/IP & UDP Socket Services
- Device drivers (Windows and Linux)
- Rack mount with RJ45 serial connectors

Device Server 32-port rack mount RJ45



Function

The ICDM-RX/TCP product family enables the connection of serial devices (RS-232 / RS-422 / RS-485) using a device driver (Windows or Linux) or Ethernet TCP/IP devices using socket services to an industrial Ethernet network. The integrated webserver enables complete configuration of all module parameters like serial interface, baud rate, parity, data bits, stop bits, or flow control. Products are available in different versions for DB9 or screw terminal connection.

Dimensions

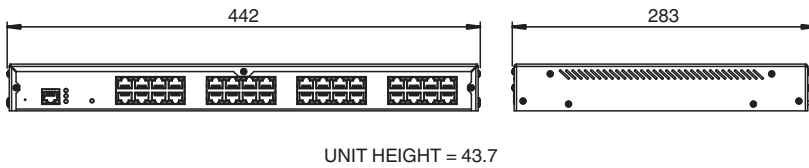

Technical Data

General specifications	
UL File Number	E185802
Functional safety related parameters	
MTBF	12.9 a
Indicators/operating means	
LED indication	see manual
Electrical specifications	
Rated operating voltage	U _e 90 ... 260 V AC
Interface	
Interface type	Software selectable interfaces: RS-232 , RS-422 , RS-485 (2 and 4-wire)
Physical	32 x RJ45
Protocol	Raw serial
Supported baud rates	300 bps to 230Kbps
Interface 1	
Interface type	Industrial Ethernet
Physical	1 x RJ45
Protocol	TCP/IP
Additional protocols	ARP, BOOTP, DHCP/RARP, HTTP, HTTPS, SSH, SSL/TLS, ICMP, RFC 1006 (ISO over TCP), SNMP (MIB-II), TCP/IP & UDP socket services, Telnet, and TFTP, and supports IP multicast data transmission
Transfer rate	10/100 Mbps
Directive conformity	

Release date: 2023-04-18 Date of issue: 2023-04-18 Filename: 70114050_eng.pdf

Technical Data

Electromagnetic compatibility	
Directive 2014/30/EU	EN 55032:2015+A11:2020 , EN 55035:2017/A11:2020
Low voltage	
Directive 2014/35/EU	EN 62368-1:2014
RoHS	EN IEC 63000:2018
Standard conformity	
Electrical safety	EN 62368-1:2014-08
Emitted interference	EN 55032, FCC Part 15 Subpart B, ICES-003, AS/NZS CISPR 32
Noise immunity	EN 55035:2017/A11:2020
Ambient conditions	
Ambient temperature	-40 ... 75 °C (-40 ... 167 °F)
Storage temperature	-40 ... 85 °C (-40 ... 185 °F)
Relative humidity	max. 95 %
Altitude	0 ... 3048 m
Mechanical specifications	
Housing length	438.2 mm
Housing width	273.4 mm
Housing height	44.2 mm
Degree of protection	IP20
Connection	Internal power supply: US and EURO cords Fieldbus: 1 x RJ45 Inputs/outputs: 32 x RJ45
Material	
Housing	steel, black coated
Mass	2.89kg
Construction type	Cabinet module
Mounting	Rack mount

Connection Assignment

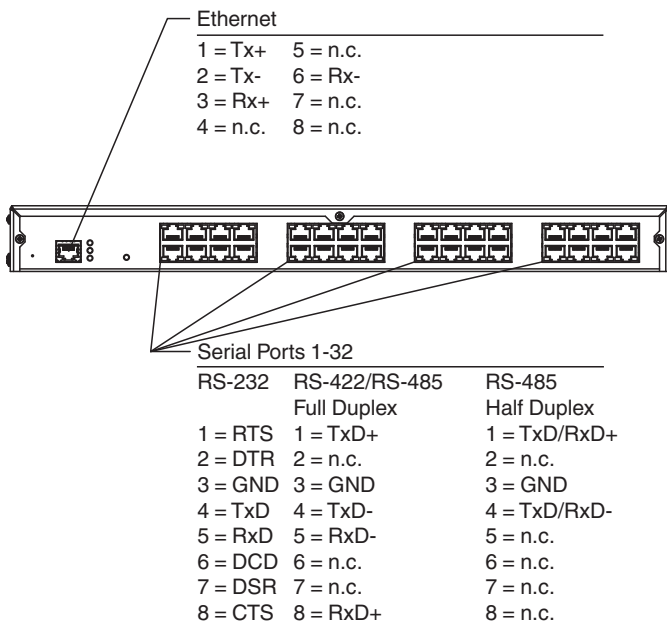





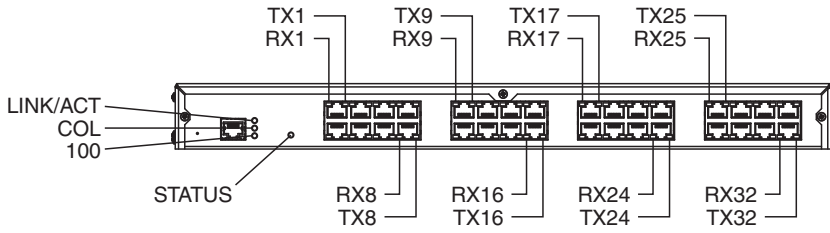

Release date: 2023-04-18 Date of issue: 2023-04-18 Filename: 70114050_eng.pdf

Assembly



Accessories

	V45-G-C5-GN1M-PUR-E1S	Ethernet bus cable male cordset single-ended RJ45, 4-pin, PUR cable green, Cat5e, shielded, UL approved, drag chain suitable
	V45-G-C5-GN3M-PUR-E1S	Ethernet bus cable male cordset single-ended RJ45, 4-pin, PUR cable green, Cat5e, shielded, UL approved, drag chain suitable
	V45-G-C5-GN10M-PUR-E1S	Ethernet bus cable male cordset single-ended RJ45, 4-pin, PUR cable green, Cat5e, shielded, UL approved, drag chain suitable
	V45-G-C5-GN1M-PUR-E1S-V45-G	Ethernet bus cable RJ45 to RJ45 PROFINET-coded, 4-pin, PUR cable green, Cat5e, shielded, UL approved, drag chain suitable
	V45-G-C5-GN3M-PUR-E1S-V45-G	Ethernet bus cable RJ45 to RJ45 PROFINET-coded, 4-pin, PUR cable green, Cat5e, shielded, UL approved, drag chain suitable
	V45-G-C5-GN10M-PUR-E1S-V45-G	Ethernet bus cable RJ45 to RJ45 PROFINET-coded, 4-pin, PUR cable green, Cat5e, shielded, UL approved, drag chain suitable
	V45-G-C5-GN20M-PUR-E1S-V45-G	Ethernet bus cable RJ45 to RJ45 PROFINET-coded, 4-pin, PUR cable green, Cat5e, shielded, UL approved, drag chain suitable