

Midas Y Series

MPPT Solar Charge Controller

User Manual



Models:MY20/MY30/MY40

Important Safety Instructions

Please keep this manual for future review.

This manual contains all instructions of safety, installation and operation for Midas Y series Maximum Power Point Tracking (MPPT) controller ("the controller" as referred to in this manual).

General Safety Information

- Read carefully all the instructions and warnings in the manual before installation.
- No user serviceable components inside the controller. DO NOT disassemble or attempt to repair the controller.
- Mount the controller indoors. Avoid exposure the components and do not allow water to enter the controller.
- Install the controller in a well ventilated place. The controller's heat sink may become very hot during operation.
- Suggest installing appropriate external fuses/breakers.
- Make sure to switch off all PV array connections and the battery fuse/breakers before controller installation and adjustment.
- Power connections must remain tight to avoid excessive heating from loose connection.

CONTENTS

1. General Information	01
1.1 Overview	01
1.2 Characteristics	02
1.3 Product Classification	03
2. Installation Instructions	03
2.1 General Installation Notes	03
2.2 PV Array Requirements	04
2.3 Wire Size	06
2.4 Mounting	07
3. Advanced Display unit	11
4. Control Parameters Setting	17
4.1 Battery types	17
4.1.1 Support battery types	17
4.1.2 Local setting	18
4.1.3 Remote Setting	19
4.2 Load working modes	22
4.2.1 LCD setting	22
4.2.2 R485 communication setting	23
4.3 Accessories (optional)	26
5. Protections, Troubleshooting and Maintenance	27
5.1 Protection	27
5.2 Troubleshooting	30
5.3 Maintenance	31
6. Technical Specifications	32
Annex I Conversion Efficiency Curves	34
Annex II Mechanical Dimension Diagram	37

1. General Information

1.1 Overview

Midas Y series controller adopt the advanced MPPT control algorithm, it can minimize the maximum power point loss rate and loss time, quickly track the maximum power point(MPP) of the PV array and obtain the maximum energy from solar array under any conditions; and it can increase the ratio of energy utilization in the solar system by 20%-30% compared with PWM charging method.

Limiting the charging power & current and reducing charging power functions ensure the system stable with over PV modules in high temperature environment. IP33 Ingress protection and isolated RS485 design further improve the controller's reliability and meet the different application requirements.

Midas Y series controller owns self-adaptive three-stage charging mode based on digital control circuit, which can effectively prolong the lifespan of battery and significantly improve the system performance. It also has comprehensive electronic protection for overcharge, overdischarge, PV & battery reverse polarity etc, to ensure the solar system more reliable and more durable. This controller can be widely used for RV, household system, field monitoring and many other applications.

Features:

- CE certification(LVD EN/IEC62109,EMC EN61000-6-1/3)
- 100% charging and discharging in working environment temperature range
- High quality and low failure rate components of ST or IR to ensure service life
- Advanced MPPT technology & ultra-fast tracking speed guarantee tracking efficiency up to 99.5%
- Maximum DC/DC transfer efficiency is as high as 98.5%, full load efficiency is up to 97.2%
- Advanced MPPT control algorithm to minimize the MPP lost rate and lost time
- Accurate recognizing and tracking of multi-peaks maximum power point
- Wide MPP operating voltage range
- Support the lead-acid and lithium batteries, programmable temperature compensation
- Limit charging power & current over rated value
- Real-time energy statistics function
- Power reduction automatically over temperature value
- Multiple load work modes
- Comprehensive electronic protection

- Isolated RS485 with 5V/200mA protected output for no power devices, with Modbus protocol
- Support monitoring and setting the parameters via APP or PC software
- IP33 Ingress protection

1.2 Characteristics



Figure 1 Product Characteristics

①	RTS* port	⑤	RS485 communication port
②	PV Terminals	⑥	Terminal protection cover
③	Battery Terminals	⑦	Display units
④	Load Terminals	⑧	Mounting Hole Φ 5mm

★If the temperature sensor is short circuit or damaged, the controller will charge or discharge according the voltage setting point at the default temperature setting of 25 °C(no temperature compensation).

1.3 Product Classification

Model	Picture	Display
MY20 MY30 MY40		LED Indicators: PV & battery & load working status Buttons: View or set the parameters or clear the error information. LCD: PV display: voltage/current /generated energy/power Battery display: voltage/current/temperature/capacity Load display: voltage/current/power/consumed energy/load working mode.

2. Installation Instructions

2.1 General Installation Notes

- Please read the entire installation instructions to get familiar with the installation steps before installation.
- Be very careful when installing the batteries, especially flooded lead-acid battery. Please wear eye protection, and have fresh water available to wash and clean any contact with battery acid.
- Keep the battery away from any metal objects, which may cause short circuit of the battery.
- Explosive battery gases may come out from the battery during charging, so make sure ventilation condition is good.
- Ventilation is highly recommended if mounted in an enclosure. Never install the controller in a sealed enclosure with flooded batteries! Battery fumes from vented batteries will corrode and destroy the controller circuits.
- Loose power connections and corroded wires may result in high heat that can melt wire insulation, burn surrounding materials, or even cause fire. Ensure tight connections and use cable clamps to secure cables and prevent them from swaying in mobile applications.
- The controller can work with lead-acid battery and lithium battery within its control scope.
- Battery connection may be wired to one battery or a bank of batteries. The following instructions refer to a singular battery, but it is implied that the battery connection can be made to either one battery or a group of batteries in a battery bank.
- Multiple same models of controllers can be installed in parallel on the same battery bank to achieve higher charging current. Each controller must have its own solar module(s).

- Select the system cables according to 5A/mm² or less current density in accordance with Article 690 of the National Electrical Code, NFPA 70.

2.2 PV Array Requirements

(1) Serial connection (string) of PV modules

As the core component of solar system, controller could be suitable for various types of PV modules and maximize converting solar energy into electrical energy. According to the open circuit voltage (Voc) and the maximum power point voltage (VMpp) of the MPPT controller, the series number of different types PV modules can be calculated. The below table is for reference only.

MY20/MY30/MY40:

System voltage	36 cell Voc<23V		48 cell Voc<31V		54 cell Voc<34V		60 cell Voc<38V	
	Max	Best	Max	Best	Max	Best	Max	Best
12V	4	2	2	1	2	1	2	1
24V	4	3	2	2	2	2	2	2

System voltage	72 cell Voc<46V		96 cell Voc<62V		Thin-Film Module Voc>80V
	Max	Best	Max	Best	
12V	2	1	1	1	1
24V	2	1	1	1	1

NOTE: The above parameter values are calculated under standard test conditions (STC (Standard Test Condition): Irradiance 1000W/m², Module Temperature 25 °C, Air Mass1.5.)

(2) Maximum PV array power

The MPPT controller has the function of charging current/power-limiting, that is, during the charging process, when the charging current or power exceeds the rated charging current or power, the controller will automatically limit the charging current or power to the rated range, which can effectively protect the charging parts of controller, and prevent damages to the controller due to the connection of some over-specification PV modules. The actual operation of PV array is as follows:

Condition 1:

Actual charging power of PV array \leq Rated charging power of controller

Condition 2:

Actual charging current of PV array \leq Rated charging current of controller

When the controller operates under “**Condition 1**” or “**Condition 2**”, it will carry out the charging as per the actual current or power; at this time, the controller can work at the maximum power point of PV array.



WARNING: When the power of PV is not greater than the rated charging power, but the maximum open-circuit voltage of PV array is more than 100V (at the lowest environmental temperature), the controller may be damaged.

Condition 3:

Actual charging power of PV array $>$ Rated charging power of controller

Condition 4:

Actual charging current of PV array $>$ Rated charging current of controller

When the controller operates under “**Condition 3**” or “**Condition 4**”, it will carry out the charging as per the rated current or power.



WARNING: When the power of PV module is greater than the rated charging power, and the maximum open-circuit voltage of PV array is more than 100V (at the lowest environmental temperature), the controller may be damaged.

According to “Peak Sun Hours diagram”, if the power of PV array exceeds the rated charging power of controller, then the charging time as per the rated power will be prolonged, so that more energy can be obtained for charging the battery. However, in the practical application, the maximum power of PV array shall be not greater than 1.5 x the rated charging power of controller. If the maximum power of PV array exceeds the rated charging power of controller too much, it will not only cause the waste of PV modules, but also increase the open-circuit voltage of PV array due to the influence of environmental temperature, which may make the probability of damage to the controller rise. Therefore, it is very important to configure the system reasonably. For the recommended maximum power of PV array for this controller, please refer to the table below:

Model	Rated Charge Current	Rated Charge Power	Max. PV Array Power	Max. PV open circuit voltage
MY20	20A	260W/12V 520W/24V	390W/12V 780W/24V	92V ^① 100V ^②
MY30	30A	390W/12V 780W/24V	580W/12V 1170W/24V	
MY40	40A	520W/12V 1040W/24V	780W/12V 1560W/24V	

① At 25 °C environment temperature

② At minimum operating environment temperature

2.3 Wire Size

The wiring and installation methods must conform to all national and local electrical code requirements.

• PV Wire Size

Since PV array output can vary due to the PV module size, connection method or sunlight angle, the minimum wire size can be calculated by the I_{sc}^* of PV array. Please refer to the value of I_{sc} in the PV module specification. When PV modules connect in series, the I_{sc} is equal to a PV modules I_{sc} . When PV modules connect in parallel, the I_{sc} is equal to the sum of the PV modules' I_{sc} . The I_{sc} of the PV array must not exceed the controller's maximum PV input current. Please refer to the table as below:

NOTE: All PV modules in a given array are assumed to be identical.

* I_{sc} =short circuit current(amps) V_{oc} =open circuit voltage.

Model	Max. PV input current	Max. PV wire size *
MY20	20A	6mm ² /10AWG
MY30	30A	10mm ² /8AWG
MY40	40A	16mm ² /6AWG

* These are the maximum wire sizes that will fit the controller terminals.



CAUTION: When the PV modules connect in series, the open circuit voltage of the PV array must not exceed 92V at 25 °C environment temperature.

• Battery and Load Wire Size

The battery and load wire size must conform to the rated current, the reference size as below:

Model	Rated Charge Current	Rated discharge current	Battery wire size	Load wire size
MY20	20A	20A	6mm ² /10AWG	6mm ² /10AWG
MY30	30A	30A	10mm ² /8AWG	10mm ² /8AWG
MY40	40A	40A	16mm ² /6AWG	16mm ² /6AWG



CAUTION: The wire size is only for reference. If there is a long distance between the PV array and the controller or between the controller and the battery, larger wires can be used to reduce the voltage drop and improve performance.



CAUTION: For the battery, the recommended wire will be selected according to the conditions that its terminals are not connected to any additional inverter.

2.4 Mounting



WARNING: Risk of explosion! Never install the controller in a sealed enclosure with flooded batteries! Do not install in a confined area where battery gas can accumulate.



WARNING: Risk of electric shock! When wiring the solar modules, the PV array can produce a high open circuit voltage, so turn off the breaker before wiring and be careful when wiring.



CAUTION: The controller requires at least 150mm of clearance above and below for proper air flow. Ventilation is highly recommended if mounted in an enclosure.

Installation Procedure:

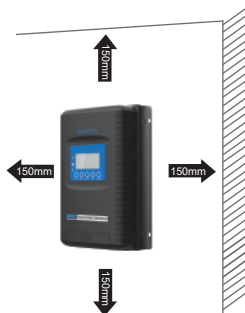

Mounting Instruction

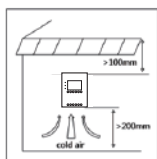

Step 1: Find a cool, dry and weather safe location for installation.

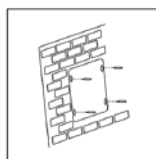

Step 2: Mark the controller's mounting holes on the mounting surface

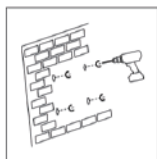

Step 3: Drill holes in the marked mounting hole location

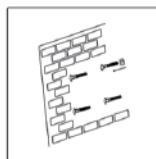

Step 4: Insert pilot screws in the mounting hole



Step 5: Fasten the controller into the pilot screws

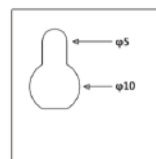

Step 6: Continue to wire battery, solar, DC load and other accessories to the controller

Figure 2-1 Mounting

Step 1: Determination of Installation Location and Heat-dissipation Space

Determination of installation location: The controller shall be installed in a place with sufficient air flow through the radiators of the controller and a minimum clearance of 150 mm from the upper and lower edges of the controller to ensure natural thermal convection. Please see Figure 2-1: Mounting



CAUTION: If the controller is to be installed in an enclosed box, it is important to ensure reliable heat dissipation through the box.

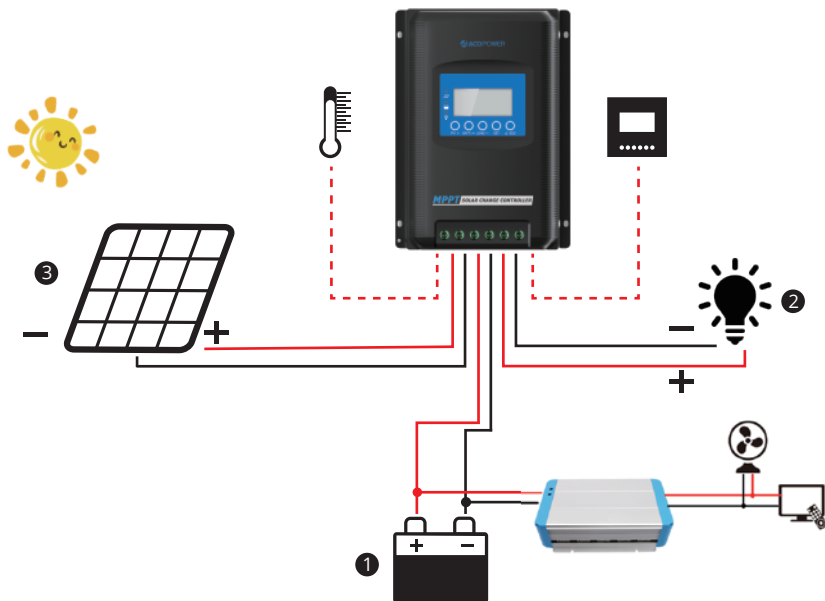

Figure 2-2 Schematic of wiring diagram

Step 2: Connect the system in the order of ① battery → ② load → ③ PV array in accordance with Figure 2-2, "Schematic Wiring Diagram" and disconnect the system in the reverse order ③ ② ①.



CAUTION: While wiring the controller do not close the circuit breaker or fuse and make sure that the leads of "+" and "-" poles are connected correctly.



CAUTION: A fuse which current is 1.25 to 2 times the rated current of the controller, must be installed on the battery side with a distance from the battery not greater than 150 mm.



CAUTION: If the controller is to be used in an area with frequent lightning strikes or unattended area, it must install an external surge arrester.



CAUTION: If an inverter is to be connected to the system, connect the inverter directly to the battery, not to the load side of the controller.

Step 3: Grounding

Midas Y series is a common-negative controller, where all the negative terminals of PV array, battery and load can be grounded simultaneously or any one of them will be grounded. However, according to the practical application, all the negative terminals of PV array, battery and load can also be ungrounded, but the grounding terminal on its shell must be grounded, which may effectively shield the electro-magnetic interference from the outside, and prevent some electric shock to human body due to the electrification of the shell.



CAUTION: For common-negative system, such as motorhome, it is recommended to use a common-negative controller; but if in the common-negative system, some common-positive equipment are used, and the positive electrode is grounded, the controller may be damaged.

Step 4: Connect accessories

- Connect the remote temperature sensor cable



Temperature Sensor



Remote Temperature Sensor Cable (Optional)

Connect the remote temperature sensor cable to the interface ① and place the other end close to the battery.



CAUTION: If the remote temperature sensor is not connected to the controller,, the default setting for battery charging or discharging temperature is 25 °C without temperature compensation.

- Connect the accessories for RS485 communication
Refer to chapter4 **“Control Parameters Setting”**.

Step 5: Powered on the controller

Closing the battery fuse will switch on the controller. Then check the status of the battery indicator (the controller is operating normally when the indicator is lit in green). Close the fuse and circuit breaker of the load and PV array. Then the system will be operating in the preprogrammed mode.





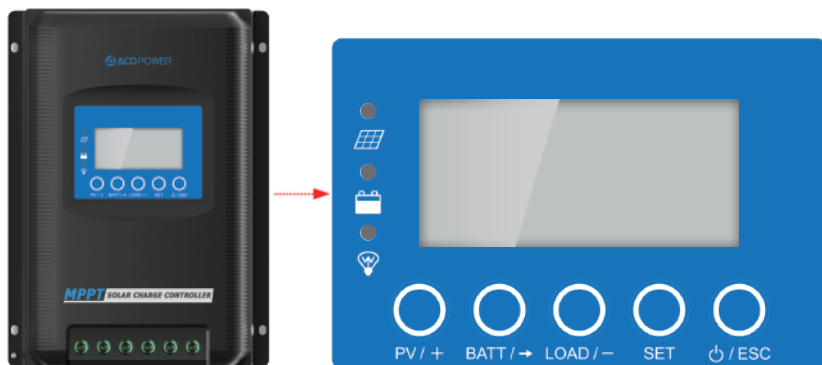

CAUTION: If the controller is not operating properly or the battery indicator on the controller shows an abnormality, please refer to 5.2 **“Troubleshooting”**

3. Adanced Display unit



(1) Indicator



Indicator	Color	Status	Instruction
	Green	On Solid	PV connection normal but low voltage(low irradiance) from PV, no charging
	Green	OFF	No PV voltage(night time) or PV connection problem
	Green	Slowly Flashing(1Hz)	In charging
	Green	Fast Flashing(4Hz)	PV Over voltage
	Green	On Solid	Normal
	Green	Slowly Flashing(1Hz)	Full
	Green	Fast Flashing(4Hz)	Over voltage
	Orange	On Solid	Under voltage



Indicator	Color	Status	Instruction
	Red	On Solid	Over discharged
	Red	Slowly Flashing(1Hz)	Battery Overheating Lithium battery Low temperature ^①
	Yellow	On Solid	Load ON
	Yellow	OFF	Load OFF
PV&BATTLED fast flashing			Controller Overheating System voltage error ^②

① When a lead-acid battery is used, the controller doesn't have the low temperature protection.

② When a lithium battery is used, the system voltage can't be identified automatically





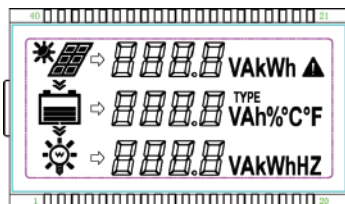

(2) Button

 PV / +	Press the button	PV browsing interface
		Setting data +
	Press the button and hold 5s	Setting the LCD cycle time
 BATT / →	Press the button	BATT browsing interface
		Cursor displacement during setting
	Press the button and hold 5s	Setting the battery type, battery capacity level and temperature unit.

 LOAD / -	Press the button	Controller load browsing interface
	Press the button and hold 5s	Setting data -
 SET	Press the button	Enter into setting interface
		Setting interface switch to the browsing interface
		Setting parameter as enter button
 ON/OFF	Press the button	Exit the setting interface

(3) Display



Icon	Information	Icon	Information	Icon	Information
	Day		Not charging		Not discharging
Icon	Information	Icon	Information	Icon	Information
	Night		Charging		Discharging

1) PV parameters

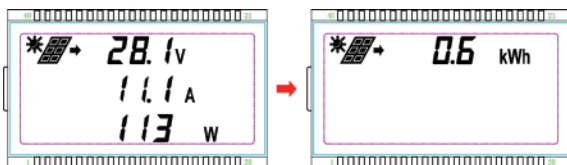

Display: Voltage/Current/Temperature/Battery capacity level

2) Battery parameters

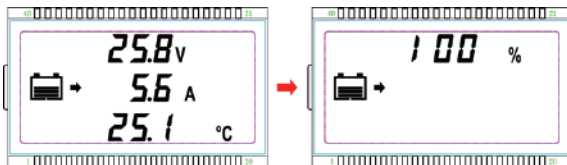

Display: Voltage/Current/Temperature/Battery capacity level

3) Load parameters

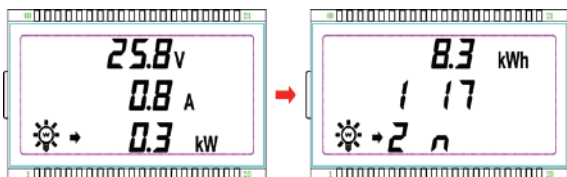

Display: Voltage/Current/Power/ Consumed energy/Load working mode-Timer1/
Load working mode-Timer2

(4) Setting parameters

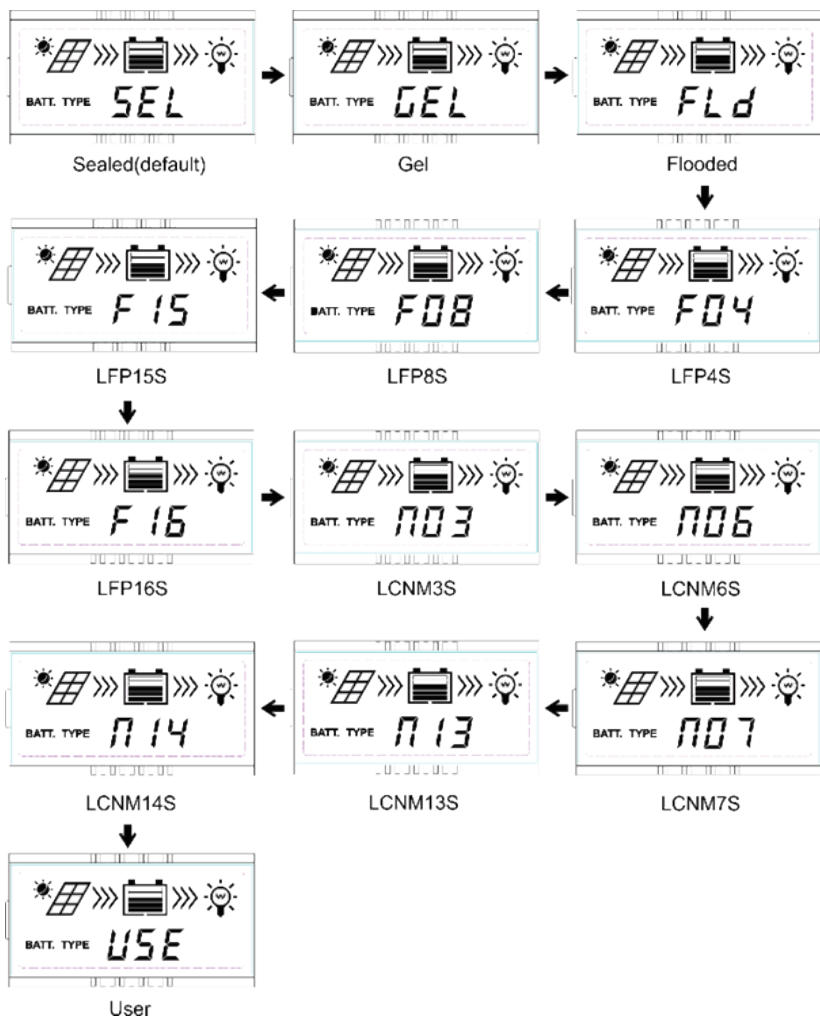

1) Battery type



Operation:

Step 1: Press the  button for the setting interface.

Step 2: Press the  button and hold 5s for the battery type interface.

Step 3: Press the  or  button to choose the battery type.

Step 4: Press the  button to confirm the battery type.



CAUTION: Please refer to chapter 4.1 for the battery control voltage setting, when the battery type is User.

2) Battery capacity





Operation:

Step 1: Press the  button for the setting interface.

Step 2: Press the  button and hold 5s for the battery type interface.

Step 3: Press the  button for the battery capacity interface.

Step 4: Press the  or  button to set the battery capacity.

Step 5: Press the  button to confirm the parameters.

3) Temperature units

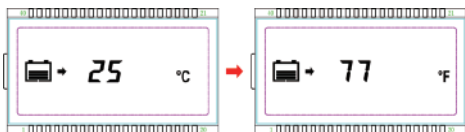



Operation:

Step 1: Press the  button for the setting interface.

Step 2: Press the  button and hold 5s for the battery type interface.

Step 3: Press the  button twice for the temperature unit interface.

Step 4: Press the  or  button to set the temperature units.





Step 5: Press the  button to confirm the parameters.

4) LCD cycle time



NOTE: The LCD cycle default time is 2s, the setting time range is 0~20s.



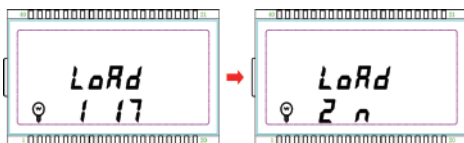

Operation:

- Step 1:** Press the  button for the setting interface.
- Step 2:** Press the  button and hold 5s for the LCD cycle time interface.
- Step 3:** Press the  or  button to set the LCD cycle time.
- Step 4:** Press the  button to confirm the parameters.

5) Local load working mode



Operation:

- Step 1:** Press the  button for the setting interface.
- Step 2:** Press the  button and hold 5s for the load working mode interface.
- Step 3:** Press the  or  button to set the working mode.
- Step 4:** Press the  button to confirm the parameters.

NOTE: Please refer to chapter 4.2 for the load working mode.

4. Control Parameters Setting

4.1 Battery types

4.1.1 Support battery types

1	Battery	Sealed(default)
		Gel
		Flooded
2	Lithium battery	LiFePO4(4S/8S/15S/16S)
		Li(NiCoMn)O2 (3S/6S/7S/13S/14S)
3	User	

Note: If the controller supports 48V system voltage, the battery type will display LiFePO4 F15/F16, and Li(NiCoMn)O2 N13/N14.















CAUTION: When the default battery type is selected, the battery voltage control parameters will be set by default and can't be changed. To change these parameters, select "User" battery type.

4.1.2 Local setting

 WARNING	When the default battery type is selected, the battery voltage parameters cannot be modified. To change these parameters, select the "USE" type.
--------------------	--

Step1: Under the "USE" battery type, the battery parameters that can be local set are shown in the table below:

Parameters	Default	Range	Settings on XDS2 module
SYS★	12VDC	12/24/36 /48VDC	1) Under the "USE" battery type, press the  button to enter the "SYS" interface. 2) Press the  button again to display the current "SYS" value. 3) Press the  or  button to modify the parameter. 4) Press the  button to confirm and enter the next parameter.
BCV	14.4V	9~17V	5) Press the  button again to display the current voltage value. 6) Press the  or  button to modify the parameter (press  button to increase 0.1V, press  button to decrease 0.1V). 7) Press the  button to confirm and enter the next parameter.
FCV	13.8V	9~17V	
LVR	12.6V	9~17V	
LVD	11.1V	9~17V	

LEN	NO	YES/NO	Press the  or  button to modify the switch status. Note: It exists automatically from the current interface after no operation of more than 10S.
-----	----	--------	---

* The SYS value can only be modified under the non-lithium "USE" type. That is, the battery type is Sealed, Gel, or Flooded before entering the "USE" type, the SYS value can be modified; if it is lithium battery type before entering the "USE" type, the SYS value cannot be modified.

Only the above battery parameters can be set on the local controller, and the remaining battery parameters follow the following logic (the voltage level of 12V system is 1, the voltage level of 24V system is 2, the voltage level of 48V system is 4).

Battery type Battery parameters	Sealed/Gel/Flooded User	LiFePO4 User	Li(NiCoMn)O2 User
Over voltage disconnect voltage	BCV+1.4V*voltage level	BCV+0.3V*voltage level	BCV+0.3V*voltage level
Charging limit voltage	BCV+0.6V*voltage level	BCV+0.1V*voltage level	BCV+0.1V*voltage level
Over voltage reconnect voltage	BCV+0.6V*voltage level	BCV+0.1V*voltage level	Boost charging voltage
Equalize charging voltage	BCV+0.2V*voltage level	Boost charging voltage	Boost charging voltage
Boost reconnect charging voltage	FCV-0.6V*voltage level	FCV-0.6V*voltage level	FCV-0.1V*voltage level
Under voltage warning reconnect voltage	UVW+0.2V*voltage level	UVW+0.2V*voltage level	UVW+1.7V*voltage level
Under voltage warning voltage	LVD+0.9V*voltage level	LVD+0.9V*voltage level	LVD+1.2V*voltage level
Discharging limit voltage	LVD-0.5V*voltage level	LVD-0.1V*voltage level	LVD-0.1V*voltage level

4.1.3 Remote Setting

1)Setting the battery parameters by PC software

Connect the controller's RJ45 interface to the PC's USB interface via a USB to RS485 cable (model: CC-USB-RS485-150U). When selecting the battery type as "USE," set the voltage parameters by the PC software. Refer to the cloud platform manual for detail.



Download software

<http://www.acopower.com>

2) Setting the battery parameters by APP

Connect the controller to the WIFI module through a standard network cable or connect to the Bluetooth module by Bluetooth signal. When selecting the battery type as "USE," set the voltage parameters by the APP. Refer to the cloud APP manual for details.

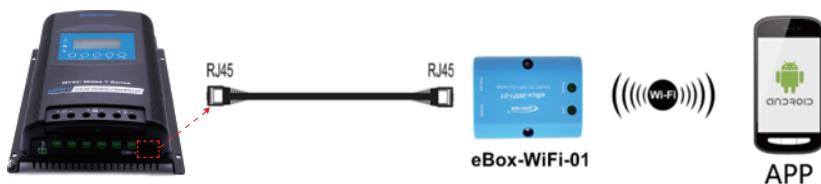

- Download software(User for lead-acid battery)
<http://www.acopower.com>
- Download software(User for lithium battery)
<http://www.acopower.com>

3) Controller parameters

Battery voltage parameters

Measure the parameters in the condition of 12V/25°C. Please double the values in the 24V system, and multiplies the values by 4 in the 48V system.

Battery type Battery Parameters	Sealed	GEL	FLD	User
Over voltage disconnect voltage	16.0V	16.0V	16.0V	9~17V
Charging limit voltage	15.0V	15.0V	15.0V	9~17V
Over voltage reconnect voltage	15.0V	15.0V	15.0V	9~17V
Equalize charging voltage	14.6V	—	14.8V	9~17V
Boost charging voltage	14.4V	14.2V	14.6V	9~17V
Float charging voltage	13.8V	13.8V	13.8V	9~17V
Boost reconnect charging voltage	13.2V	13.2V	13.2V	9~17V
Low voltage reconnect voltage	12.6V	12.6V	12.6V	9~17V
Under voltage warning reconnect voltage	12.2V	12.2V	12.2V	9~17V

Battery parameters \ Battery type	Sealed	GEL	FLD	User
Under voltage warning voltage	12.0V	12.0V	12.0V	9~17V
Low voltage disconnect voltage	11.1V	11.1V	11.1V	9~17V
Discharging limit voltage	10.6V	10.6V	10.6V	9~17V
Equalize Duration	120 minutes	--	120 minutes	0~180 minutes
Boost Duration	120 minutes	120 minutes	120 minutes	10~180 minutes

• When the battery type is "USE," the battery voltage parameters follow the following logic:

- A. Over Voltage Disconnect Voltage > Charging Limit Voltage ≥ Equalize Charging Voltage ≥ Boost Charging Voltage ≥ Float Charging Voltage > Boost Reconnect Charging Voltage.
- B. Over Voltage Disconnect Voltage > Over Voltage Reconnect Voltage
- C. Low Voltage Reconnect Voltage > Low Voltage Disconnect Voltage ≥ Discharging Limit Voltage.
- D. Under Voltage Warning Reconnect Voltage > Under Voltage Warning Voltage ≥ Discharging Limit Voltage;
- E. Boost Reconnect Charging voltage > Low Voltage Reconnect Voltage.

① The battery parameters under the "User" battery type is 9-17V for LFP4S.

They should x2 for LFP8S, and x4 for LFP15S/LFP16S.

Battery parameters \ Battery type	LCNM					
	LCNM3S	LCNM6S	LCNM7S	LCNM13S	LCNM14S	User [®]
Over voltage disconnect voltage	12.8 V	25.6 V	29.8 V	55.4V	59.7V	9~17V
Charging limit voltage	12.6 V	25.2 V	29.4 V	54.6V	58.8V	9~17V
Over voltage reconnect voltage	12.5 V	25.0 V	29.1 V	54.1V	58.3V	9~17V
Equalize charging voltage	12.5 V	25.0 V	29.1 V	54.1V	58.3V	9~17V
Boost charging voltage	12.5 V	25.0 V	29.1 V	54.1V	58.3V	9~17V
Float charging voltage	12.2 V	24.4 V	28.4 V	52.8V	56.9V	9~17V
Boost reconnect charging voltage	12.1 V	24.2 V	28.2 V	52.4V	56.4V	9~17V

Battery parameters	Battery type					
	LCNM					
	LCNM3S	LCNM6S	LCNM7S	LCNM13S	LCNM14S	User ^①
Low voltage reconnect voltage	10.5 V	21.0 V	24.5 V	45.5V	49.0V	9~17V
Under voltage warning reconnect voltage	12.2 V	24.4 V	28.4 V	52.8V	56.9V	9~17V
Under voltage warning voltage	10.5 V	21.0 V	24.5 V	45.5V	49.0V	9~17V
Low voltage disconnect voltage	9.3 V	18.6 V	21.7 V	40.3V	43.4V	9~17V
Discharging limit voltage	9.3 V	18.6 V	21.7 V	40.3V	43.4V	9~17V

① The battery parameters under the “User” battery type is 9~17V for LFP4S. They should x2 for LFP8S, and x4 for LFP15S/LFP16S.

• When the battery type is “USE,” the Lithium battery voltage parameters follow the following logic:

- A. Over Voltage Disconnect Voltage > Over Charging Protection Voltage (Protection Circuit Modules (BMS)) + 0.2V;
- B. Over Voltage Disconnect Voltage > Over Voltage Reconnect Voltage = Charging Limit Voltage ≥ Equalize Charging Voltage = Boost Charging Voltage ≥ Float Charging Voltage > Boost Reconnect Charging Voltage;
- C. Low Voltage Reconnect Voltage > Low Voltage Disconnect Voltage ≥ Discharging Limit Voltage.
- D. Under Voltage Warning Reconnect Voltage > Under Voltage Warning Voltage ≥ Discharging Limit Voltage;
- E. Boost Reconnect Charging voltage > Low Voltage Reconnect Voltage;
- F. Low Voltage Disconnect Voltage ≥ Over Discharging Protection Voltage (BMS) + 0.2V

 CAUTION	<p>The required accuracy of BMS is no higher than 0.2V. We will not assume responsibility for the abnormal when the accuracy of BMS is higher than 0.2 v.</p>
---	---

4.2 Load working modes

4.2.1 LCD setting

1) LCD display and operation

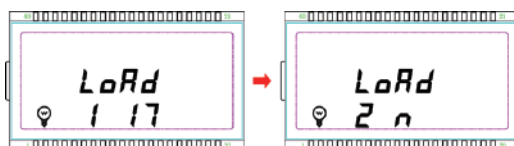

When the LCD shows above interface, operate as following:

Step1: Press the  button for the setting interface.

Step2: Press the  button and hold 5s for the load working mode interface.

Step3: Press the  or  button to set the load working modes.

Step4: Press the  button to confirm the parameters.

2) Load working mode

1**	Timer 1	2**	Timer 2
100	Light ON/OFF	2 n	Disabled
101	Load will be on for 1 hour after sunset	201	Load will be on for 1 hour before sunrise
102	Load will be on for 2 hour after sunset	202	Load will be on for 2 hour after sunset
103 ~ 113	Load will be on for 3~13 hour before sunrise	203 ~ 213	Load will be on for 3~13 hour before sunrise
114	Load will be on for 14 hour after sunset	214	Load will be on for 14 hour after sunset
115	Load will be on for 15 hour after sunset	215	Load will be on for 15 hour after sunset

116	Test mode	2 n	Disabled
117	Manual mode(Default load ON)	2 n	Disabled



CAUTION: Please set Light ON/OFF, Test mode and Manual mode via Timer1. Timer2 will be disabled and display "2 n".

4.2.2 R485 communication setting

• 1) Load working mode

Manual Control (default)

Control ON/OFF of the load via the button or remote commands (e.g., APP or PC software).

- Light ON/OFF

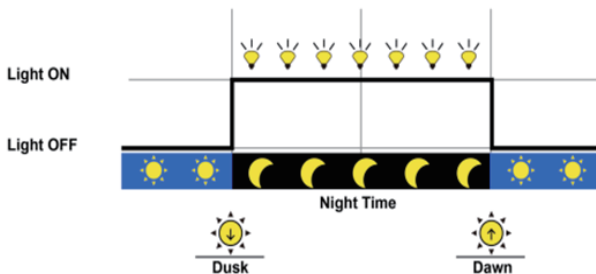

- Light ON+ Timer

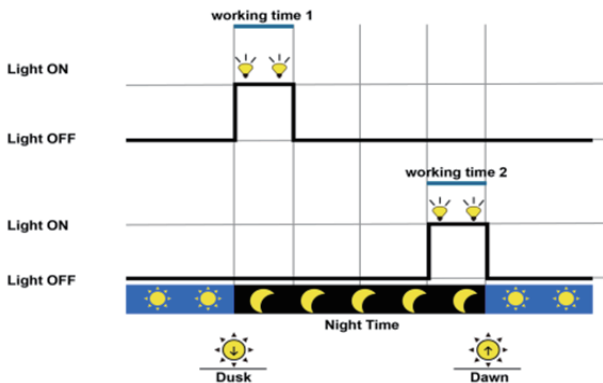

- Time Control
Control the load ON/OFF time through setting the real-time clock.

2) Load working mode settings

(1) PC setting

- Connection

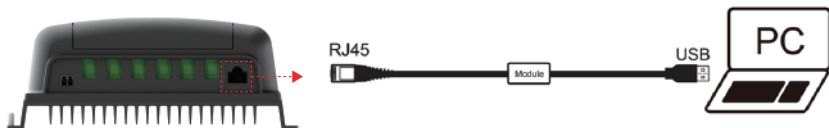

- Download software
<http://www.acopower.com>

(2) APP software setting

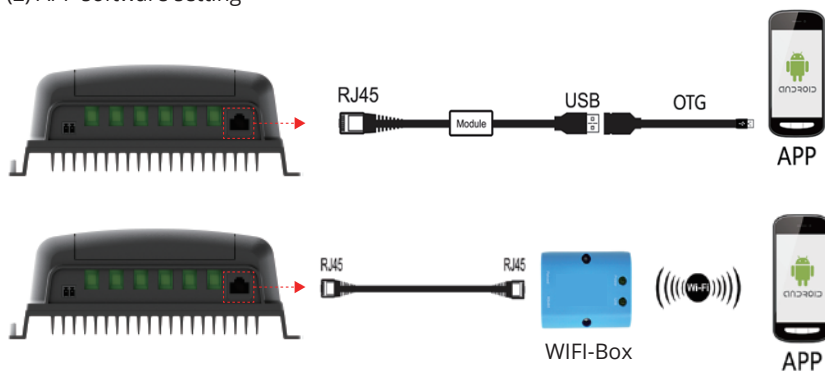



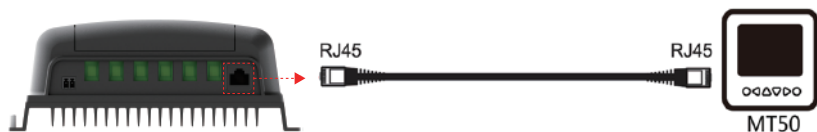

- Download software
<http://www.acopower.com>



(3) MT50 Setting

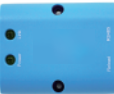

CAUTION: For detailed setting methods, please refer to the instructions or contact after-sales support.

4.3 Accessories (optional)

<p>Remote Temperature Sensor</p>		<p>Acquisition of battery temperature for undertaking temperature compensation of control parameters, the standard length of the cable is 3m (length can be customized). The Remote Temperature connects to the port (4th) on the controller.</p> <p>NOTE: The temperature sensor short-circuited or damaged, the controller will be charging or discharging at the default temperature 25 °C.</p>
<p>USB to RS485 cable</p>		<p>USB to RS485 converter is used to monitor each controller using Solar Station PC software. The length of cable is 1.5m. The USB to RS485 connects to the RS485 Port on the controller.</p>
<p>OTG cable OTG-12CM</p>		<p>Used to connect the controller with mobile phone and able to achieve real-time monitoring of the controller and modification of the parameters by using mobile APP software.</p>
<p>Remote Meter MT50</p>		<p>MT50 can display various operating data and fault info the system. The information can be displayed on a backlit LCD screen, the buttons are easy-to-operate, and the numeric display is readable.</p>
<p>WIFI Serial Adapter</p>		<p>After the controller is connected with the WIFI-Box through the standard Ethernet cable (parallel cable), the operating status and related parameters of the controller can be monitored by the mobile APP software through WIFI signals.</p>

<p>RS485 to Bluetooth Adapter</p>		<p>After the controller is connected with the BLE-Box through the standard Ethernet cable (parallel cable), the operating status and related parameters of the controller can be monitored by the mobile APP software through Bluetooth signals.</p>
<p>Logger</p>		<p>After the controller is connected with the logger through the RS485 communication cable, it can record the operating data of the controller or monitor the real-time operating status of the controller via PC software.</p>
<p>NOTE: For setting and operation of accessory, please refer to accessory's user manual.</p>		

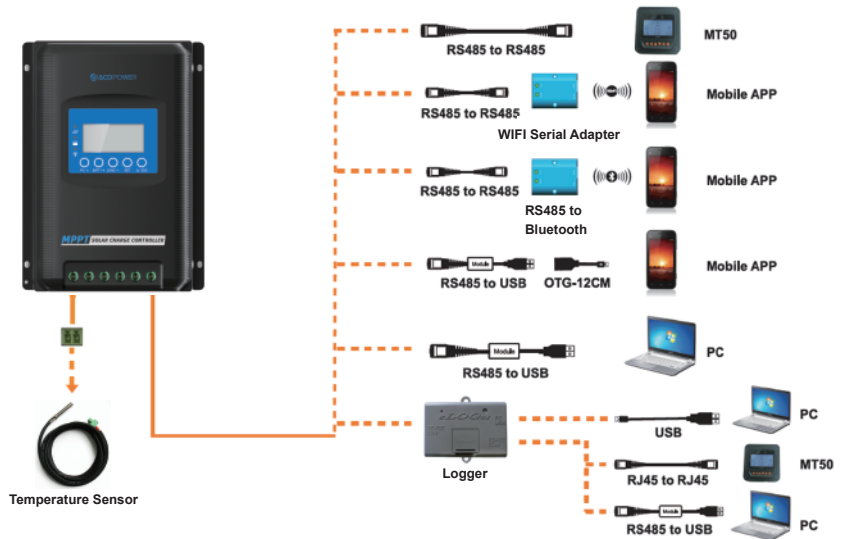

5. Protections, Troubleshooting and Maintenance







5.1 Protection



PV Over Current/power	<p>When the charging current or power of the PV array exceeds the controller's rated current or power, it will be charge at the rated current or power.</p> <p>NOTE: When the PV modules are in series, ensure that the open-circuit voltage of the PV array does not exceed the "maximum PV open-circuit voltage" rating. Otherwise the controller may be damaged.</p>
PV Short Circuit	<p>When not in PV charging state, the controller will not be damaged in case of a short-circuiting in the PV array.</p>
PV Reverse Polarity	<p>When the polarity of the PV array is reversed, the controller may not be damaged and can continue to operate normally after the polarity is corrected.</p> <p>NOTE: If the PV array is reverse connected to the controller, 1.5 times rated controller power(watts)from the PV array, will damage the controller.</p>
Night Reverse Charging	<p>Prevents the battery from discharging to the PV module at night.</p>
Battery Reverse Polarity	<p>Fully protected against battery reverse polarity; no damage will occur to the battery. Correct the miswire to resume normal operation.</p> <p>NOTE: Limited to the characteristic of lithium battery, when the PV connection is correct and battery connection reversed, the controller will be damaged.</p>
Battery Over Voltage	<p>When the battery voltage reaches the over voltage disconnect voltage, it will automatically stop battery charging to prevent battery damage caused by over-charging.</p>
Battery Over Discharge	<p>When the battery voltage reaches the low voltage disconnect voltage, it will automatically stop battery discharging to prevent battery damage caused by over-discharging. (Any controller connected loads will be disconnected. Loads directly connected to the battery will not be affected and may continue to discharge the battery.)</p>
Battery Overheating	<p>The controller can detect the battery temperature through an external temperature sensor. The controller stops working when its temperature exceeds 65 °C and restart to work when its temperature is below 55 °C.</p>

Lithium Battery Low Temperature	When the temperature detected by the optional temperature sensor is lower than the Low Temperature Protection Threshold(LTPT), the controller will stop charging and discharging automatically. When the detected temperature is higher than the LTPT, the controller will be working automatically (The LTPT is 0 °C by default and can be set within the range of 10 ~ -40 °C).
Load Short Circuit	When the load is short circuited (The short circuit current is ≥ 4 times the rated controller load current), the controller will automatically cut off the output. If the load reconnects the output automatically five times (delay of 5s, 10s, 15s, 20s, 25s), it needs to be cleared by pressing the Load button, restarting the controller or switching from Night to the Day (nighttime > 3 hours).
Load Overload	When the load is overloading (The overload current is ≥ 1.05 times the rated load current), the controller will automatically cut off the output. If the load reconnects automatically five times (delay of 5s, 10s, 15s, 20s, 25s), it needs to be cleared by pressing the Load button restarting the controller, switching from Night to Day (nighttime > 3 hours).
Controller ★ Overheating	The controller is able to detect the temperature inside the battery. The controller stops working when its temperature exceeds 85 °C and restart to work when its temperature is below 75 °C.
TVS High Voltage Transients	The internal circuitry of the controller is designed with Transient Voltage Suppressors (TVS) which can only protect against high-voltage surge pulses with less energy. If the controller is to be used in an area with frequent lightning strikes, it is recommended to install an external surge arrester.

★When the internal temperature is 81 °C, the reduce charging power mode which reduce the charging power of 5%,10%,20%,40% every increase 1 °C is turned on. If the internal temperature is greater than 85 °C, the controller will stop charging. When the temperature declines to be below 75 °C, the controller will resume.

5.2 Troubleshooting

Possible reasons	Faults	Troubleshooting
PV array disconnection	Charging LED indicator off during daytime when sunshine falls on PV modules properly.	Confirm that PV wire connections are correct and tight.
Battery voltage is lower than 8V	Wire connection is correct, the controller is not working.	Please check the voltage of battery. At least 8V voltage to activate the controller.
Battery over voltage	Charging indicator Green fast flashing Battery level shows full, battery frame blink, fault icon blink.  	Check if battery voltage is higher than OVD(over voltage disconnect voltage), and disconnect the PV.
Battery over discharged	Charging indicator Red on solid Battery level shows empty, battery frame blink, fault icon blink.  	When the battery voltage is restored to or above LVR(low voltage reconnect voltage), the load will recover.
Battery Overheating	Battery indicator Red slow flashing Battery frame blink, fault icon blink.  	The controller will automatically turn the system off. When the temperature declines to be below 55 °C, the controller will resume.
Controller Overheating	PV/BATT indicator fast flashing	When heat sink of controller exceeds 85 C , the controller will automatically cut off input and output circuit. When the temperature below 75 C ,the controller will resume to work.

Possible reasons	Faults	Troubleshooting
System voltage error	PV/BATT indicator fast flashing	① Check whether the battery voltage match with the controller working voltage. ② Please change to a suitable battery or reset the working voltage.
Load Overload	1. The load is no output 	① Please reduce the number of electric equipments. ② Restart the controller. ③ Wait for one night-day cycle (night time>3 hours).
Load Short Circuit	 Load and fault icon blink	① Check carefully loads connection, clear the fault. ② Restart the controller. ③ Wait for one night-day cycle (night time>3 hours).

5.3 Maintenance

The following inspections and maintenance tasks are recommended at least two times per year for best performance.

- Make sure controller firmly installed in a clean and dry ambient.
- Make sure no block on air-flow around the controller. Clear up any dirt and fragments on heat sink.
- Check all the naked wires to make sure insulation is not damaged for sun exposure, frictional wear, dryness, insects or rats etc. Repair or replace some wires if necessary.
- Tighten all the terminals. Inspect for loose, broken, or burnt wire connections.
- Check and confirm that LED is consistent with required. Pay attention to any troubleshooting or error indication .Take corrective action if necessary.
- Confirm that all the system components are ground connected tightly and correctly.
- Confirm that all the terminals have no corrosion, insulation damaged, high temperature or burnt/discolored sign, tighten terminal screws to the suggested torque.

- Clear up dirt, nesting insects and corrosion in time.
- Check and confirm that lightning arrester is in good condition. Replace a new one in time to avoid damaging of the controller and even other equipments.



WARNING: Risk of electric shock!

Make sure that all the power is turned off before above operations, and then follow the corresponding inspections and operations.

6. Technical Specifications

Electrical Parameters

Item	MY20	MY30	MY40
System nominal voltage	12/24VDC ^① Auto		
Rated charge current	20A	30A	40A
Rated discharge current	20A	30A	40A
Battery voltage range	8 ~ 32V		
Max. PV open circuit voltage	100V ^②		92V ^③
MPPT voltage range	(Battery voltage +2V) ~ 72V		
Rated charge power	260W/12V 520W/24V	390W/12V 780W/24V	520W/12V 1040W/24V
Max. conversion efficiency	98.3%	98.6%	98.6%
Full load efficiency	96.4%	96.6%	96.5%
Self-consumption	≤30mA(12V)		≤16mA(24V)
Discharge circuit voltage drop	≤0.23V		
Temperature compensate coefficient ^④	-3mV/°C/2V (Default)		
Grounding	Common negative		
RS485 interface	5VDC/200mA(RJ45)		
LCD backlight time	Default:60S,Range:0~999S (0S:the backlight is ON all the time)		

① When lithium battery is used, the system voltage can't be identified automatically.

② At minimum operating environment temperature

③ At 25°C environment temperature

④ When lithium battery is used, the temperature compensate coefficient must be 0, and can't be changed.

Environmental Parameters

Item	MY20	MY30	MY40
Working environment temperature (100% input and output) ◆	-25℃ ~ +50℃ (LCD)		
Storage temperature range	-20℃ ~ +70℃		
Relative humidity	≤95%, N.C.		
Enclosure	IP33 ★		
Pollution degree	PD2		

◆ The controller can full load working in the working environment temperature, When the internal temperature reach to 81℃, the reducing charging power mode is turned on.

★ 3-protection against solid objects: protected against solids objects over 2.5mm.
3-protected against sprays to 60° from the vertical.

Mechanical Parameters

Item	MY20	MY30	MY40
Dimension	217×158×56.5mm	230×165×63mm	255×185×67.8mm
Mounting dimension	160×149mm	173×156mm	200×176mm
Mounting hole size	Φ5mm		
Terminal	6AWG(16mm ²)	6AWG(16mm ²)	6AWG(16mm ²)
Recommended cable	10AWG(6mm ²)	8AWG(10mm ²)	6AWG(16mm ²)
Weight	0.96kg	1.31kg	1.70kg

Certification

Safety	EN/IEC62109-1
EMC(Emission immunity)	EN61000-6-3/EN61000-6-1
FCC	47 CFR Part 15, Subpart B
Performance &function	IEC62509
ROHS	IEC62321-3-1

Annex I Conversion Efficiency Curves

Illumination Intensity: 1000W/m² Temp: 25°C

Model: MY20

1. Solar Module MPPT Voltage(17V, 34V) / Nominal System Voltage(12V)

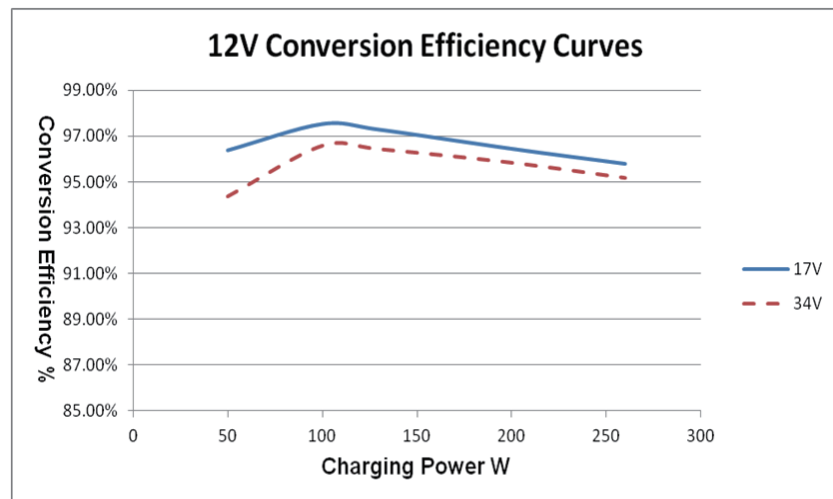

2. Solar Module MPPT Voltage(34V,51V,68V) / Nominal System Voltage(24V)

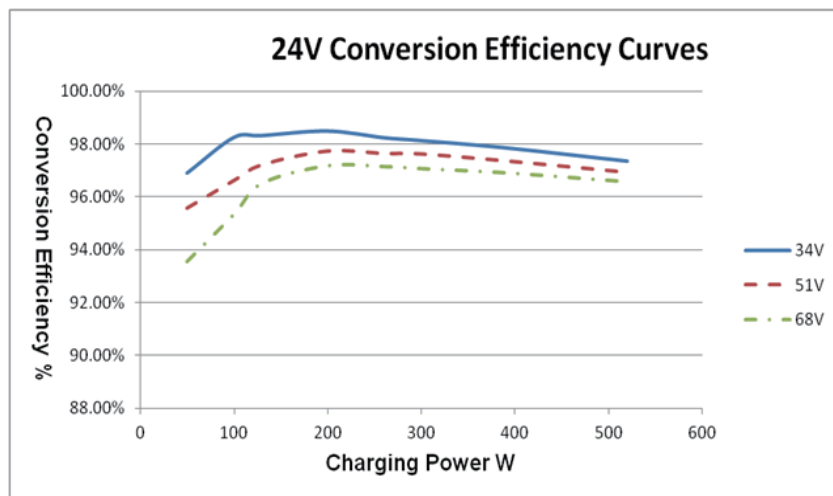

Model: MY30

1. Solar Module MPP Voltage(17V, 34V) / Nominal System Voltage(12V)

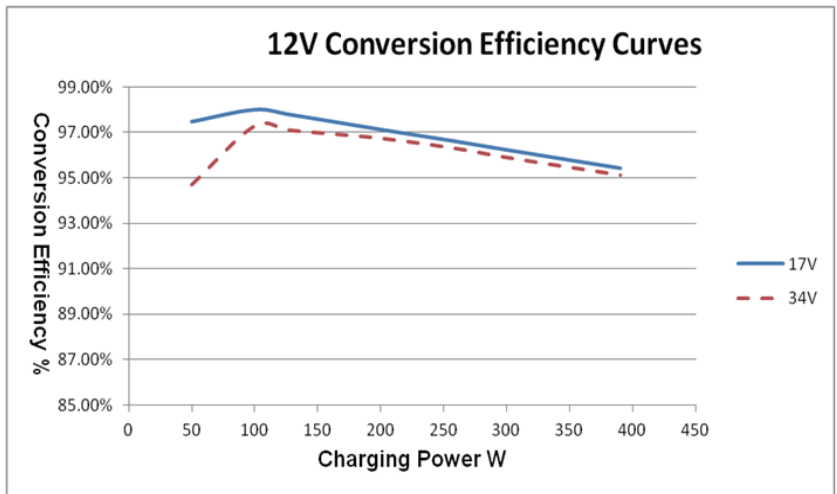

2. Solar Module MPP Voltage(34V,51V,68V) / Nominal System Voltage(24V)

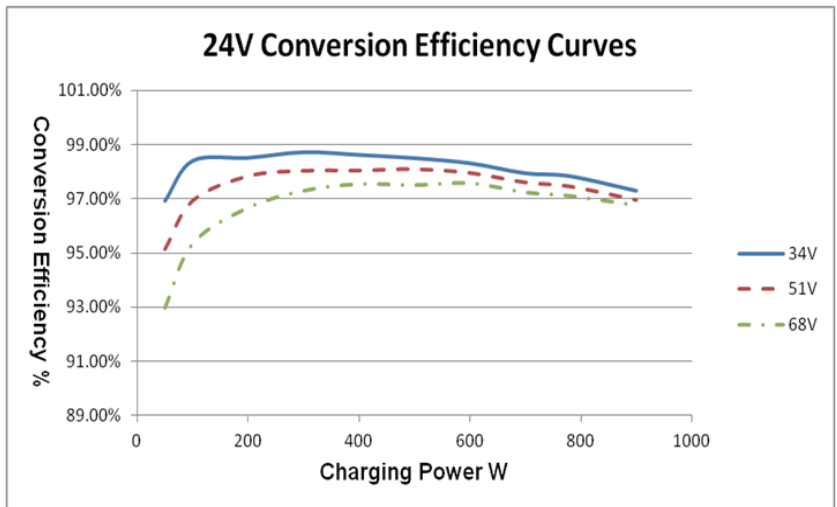

Model: MY40

1.Solar Module MPP Voltage(17V, 34V) / Nominal System Voltage(12V)

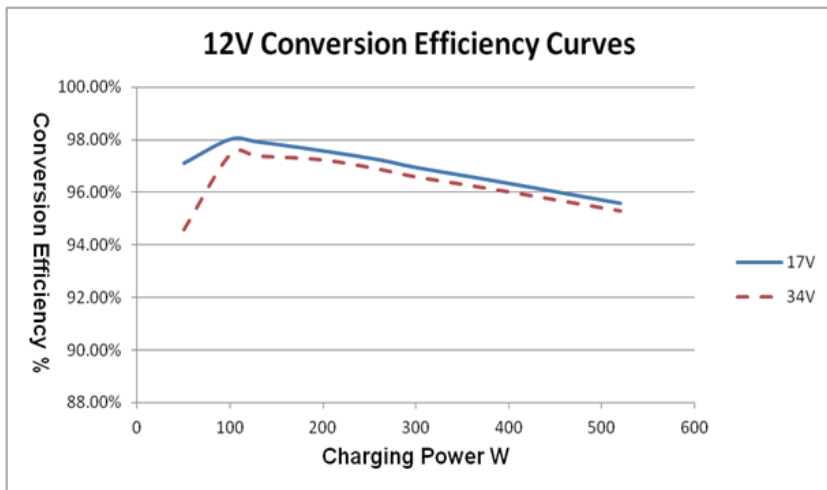

2. Solar Module MPP Voltage(34V, 51V,68V) / Nominal System Voltage(24V)

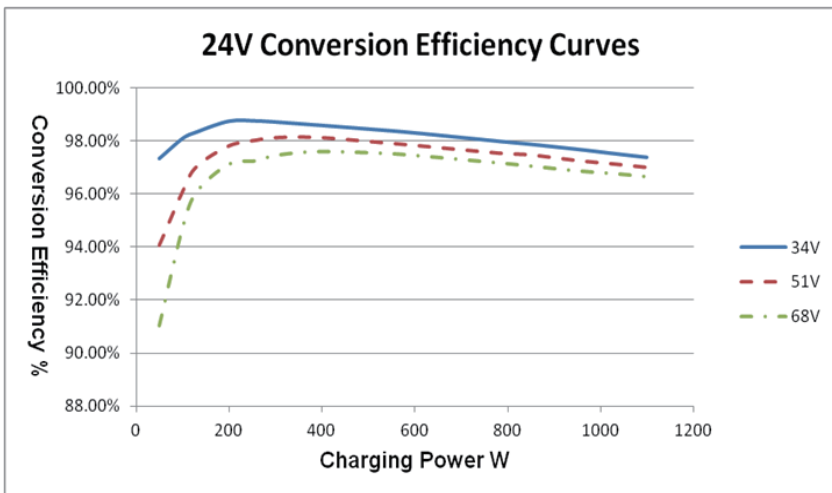

Annex II Mechanical Dimension Diagram

MY20(Unit: mm)

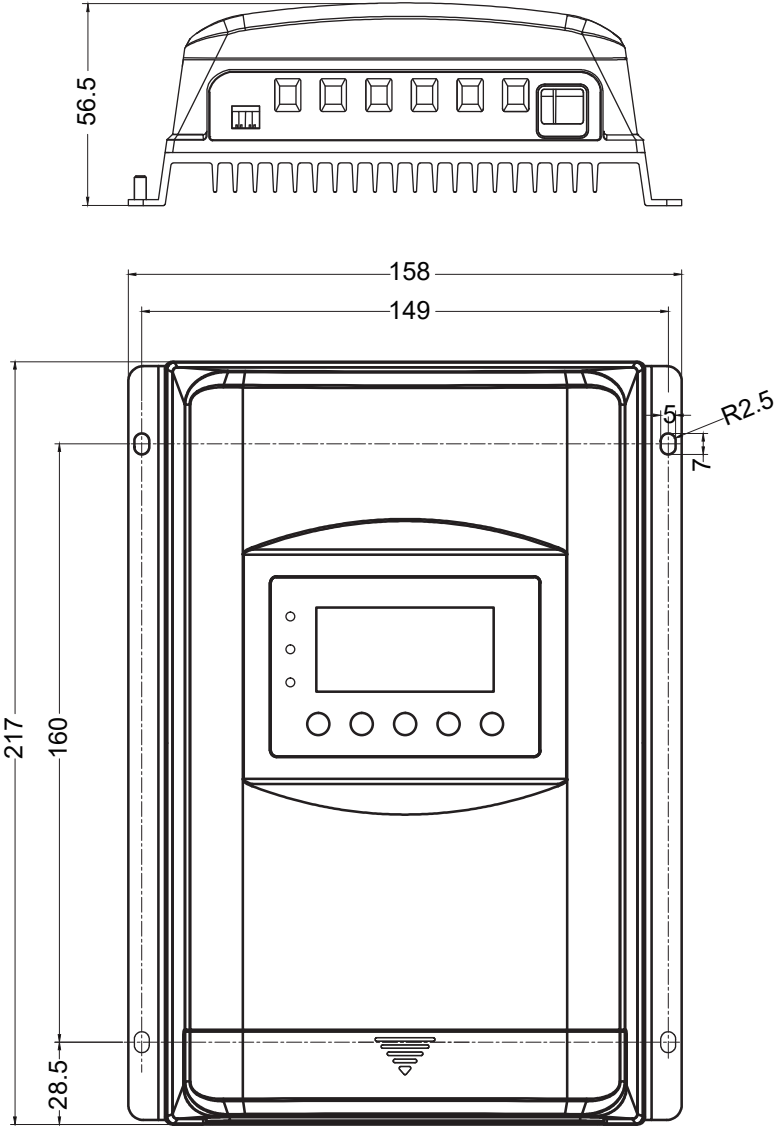

MY30(Unit: mm)

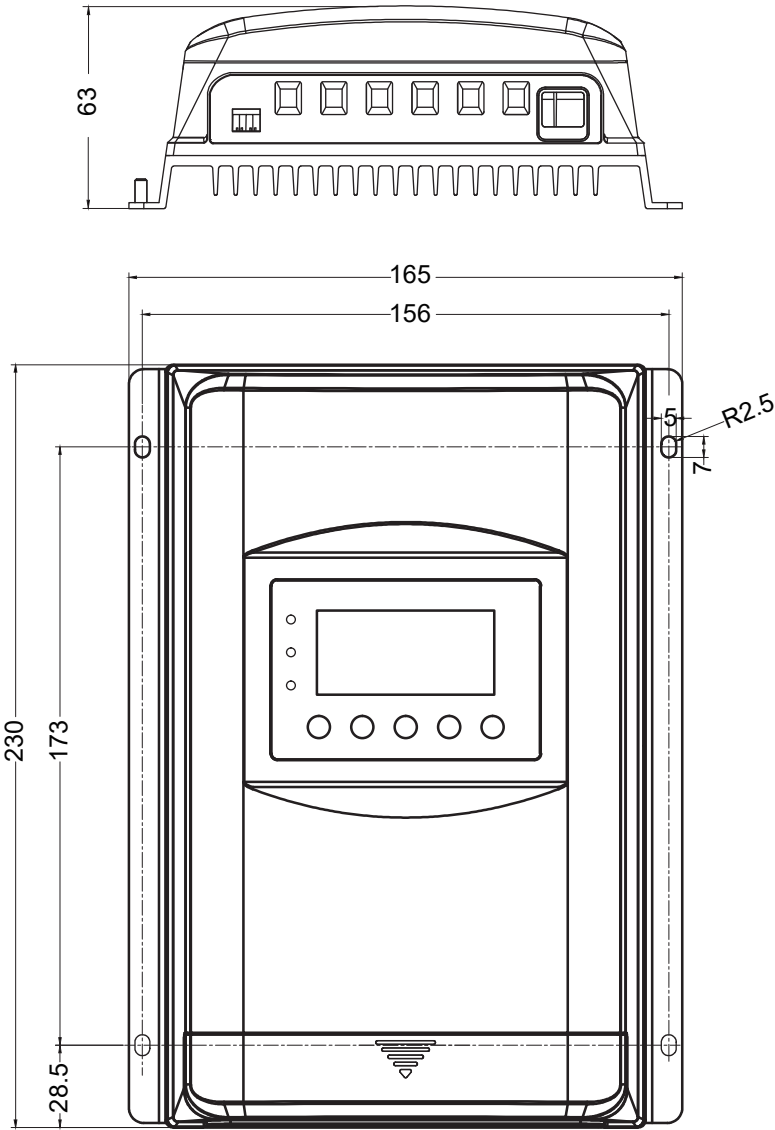

MY40(Unit: mm)

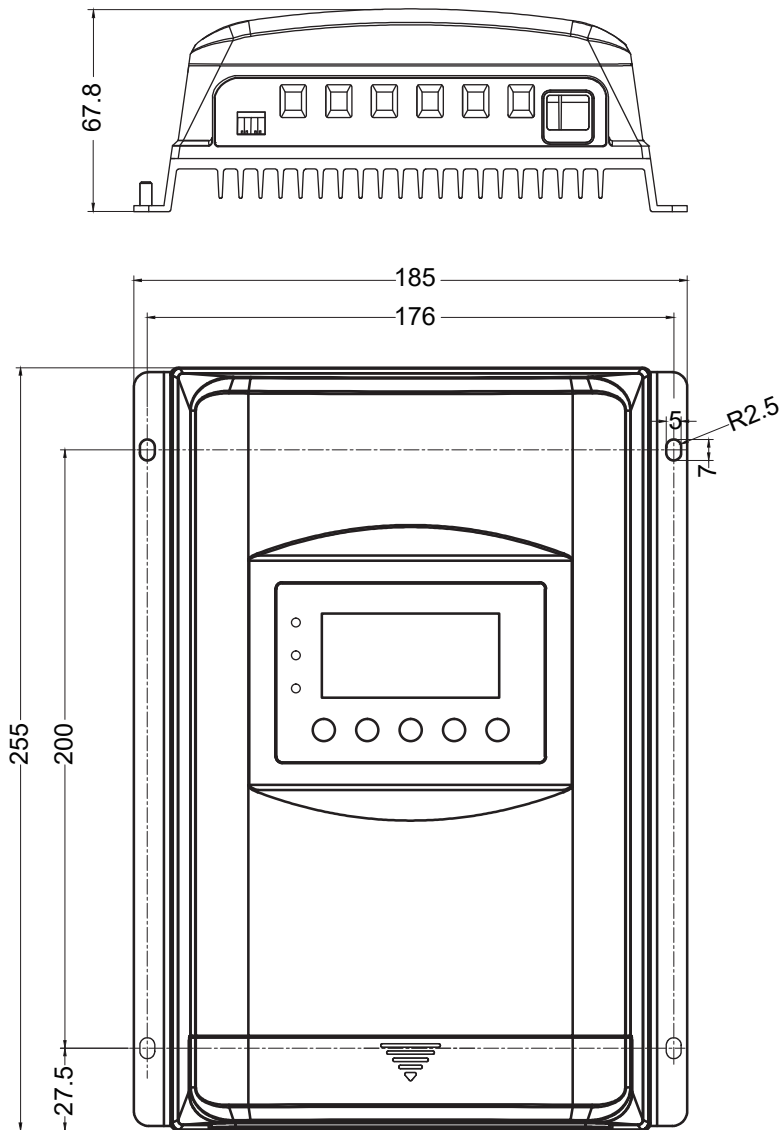



Add: 4120 Valley Blvd, Walnut, CA 91789,USA

Tel: 1.626.575.7722

Email:sales@acopower.com

Web:www.acopower.com